

2012-2013

# Solution Selection Guide



Automation Control Systems  
Drives & Motion Controls  
Temperature & Process Controls  
Sensors & Vision  
Industrial Components

## BETTER MACHINES, NEW MARKETS

OMRON Automation and Safety is a leading global supplier of automation systems serving industrial customers. Our comprehensive product lines and application expertise are delivered via a well-trained distribution channel. They work with you to solve demanding automation challenges and apply the advanced technology built into Omron products.

We support machine builders and OEMs across the United States, Canada and Latin America with sensing and control technologies that help you deliver more capable and profitable machines in less time. We strive to be your trusted partner in automation. Leverage our industry expertise and powerful yet simple solutions in your next project.

***“We help customers build superior automated machines that are easy to use, install and integrate.”***

### Omron Facts

- Almost 80 years in the controls business, founded in 1933
- \$7.7 billion sales (USD, April 2012)
- 44% of our sales come from industrial automation; electronic components, social systems, automotive electronics and healthcare make up the balance
- 35,684 employees worldwide

### Primary Industries Served

- Automotive
- Food/Beverage
- Semiconductor
- Electronics and Small Parts Assembly
- Pharmaceutical/Cosmetics

### Automation Expertise

- Packaging & Material Handling
- Measurement & Gauging
- Inspection
- Track & Trace
- Quality Improvement

### Core Competencies

- Sensing and Controls Technologies

## Find Information Fast

### Quick Link Shortens Your Search

Quick Links are unique codes assigned to Omron products listed in this guide. Enter Quick Link codes in the Search box on [Omron247.com](http://Omron247.com) to access detailed information on products in this guide:

- Data sheets, brochures, manuals
- CAD, EDS and ESI files



### Use Our Automation Expertise

To find an authorized Omron Automation and Safety Distributor in your area simply use our Search Center on [Omron247.com](http://Omron247.com).



To reach our Technical Support team call:  
1-800-55-OMRON (1-800-556-6766)  
From Mexico: 001-800-556-6766  
Email: [ia.techsupport@omron.com](mailto:ia.techsupport@omron.com)

## Contents

Section	Products
	<b>Automation Control Systems</b>
A	Programmable Controllers
B	Operator Interface Terminals
C	Distributed I/O
D	Software
	<b>Drives &amp; Motion Controls</b>
E	Servo & AC Drives
F	Motion Controllers & Encoders
	<b>Temperature &amp; Process Controls</b>
G	Temperature & Process Controllers
	<b>Sensors &amp; Vision</b>
H	Proximity Sensors
I	Photoelectric Sensors
J	Fiber-Optic Sensors
K	Amplified Photomicrosensors
L	Measurement Sensors
M	Ultrasonic Sensors
N	Vision Solutions
	<b>Code Readers &amp; RFID</b>
O	Code Readers & RFID
	<b>Industrial Components</b>
P	Relays
Q	Pushbuttons & Indicators
R	Limit & Basic Switches
S	Timers
T	Counters
U	Metering Devices
V	Power Supplies
W	Part Number Index, NEMA and IP Ratings

# Great Machines Need a Robust Architecture



**ONE Controller    ONE Connection    ONE Software**

## Sysmac Automation Platform

Omron's proven Sysmac platform delivers complete machine control through one controller, with one connection and one software. This architecture represents a major milestone in resolving the integration of control technologies without sacrificing performance.

The guiding principles behind the Sysmac automation platform are:

- One control for the entire machine or production cell
- Harmony between the machine and its developers as well as users
- Open communication and open programming standards for ease of adoption

The result is a powerful and robust automation platform with the new NJ-Series Machine Automation Controller (MAC), that integrates motion, sequencing, networking, and vision inspection within a new software (Sysmac Studio). This true Integrated Development Environment includes configuration, programming, simulation, and monitoring with a fast machine network (EtherCAT) to control motion, vision, sensors and actuators.

## Omron Maximizes the Investment in Automation

An immediate benefit of the architecture is the seamless integration of multiple, specialized controllers with exacting system synchronization to deliver high performance throughput on a single controller. This results in measurable improvements in productivity, yield, and uptime, and waste reduction.

Omron made sure to maintain seamless compatibility with existing hardware whether using the new NJ Machine Automation Controllers or CJ/CS/CP PLCs. The Sysmac NJ leverages pre-existing PLC hardware, like I/O, communication, and RFID interface modules for the CJ Series, as well as servos and drives. By doing this, the one Machine Automation Controller ensures not only speed, power, and flexibility to solve the most complex applications, but also protection of investment.

# Scalable Machine Automation Solutions

From simple function machines to flexible manufacturing cells, Omron offers the products and know-how to fashion a cost-effective, high performing solution scaled to the requirements.

## X-Stream Automation

### Lean Automation



CP1 PLC with built-in pulse output for position control

### Mainstream Automation



CJ series hybrid PLC and motion with networked control



Sysmac NJ and TJ Trajexia stand-alone for complete machine automation control for up to 64 axes synchronized.

## Expert Integration of Safety and Automation

Take advantage of the powerful combination of STI safety knowledge and Omron global automation experience to protect your machines and production operations. Let our qualified experts conduct a machine and process safeguarding assessment and prepare a risk reduction solution to guide your safety investment. The assessment/risk reduction report shows your plan to achieve compliance with relevant regulations and standards. When you are ready to implement the plan, Omron STI can install your system and train staff to operate and maintain the safety systems for compliant protection. Visit [www.sti.com](http://www.sti.com) for details.



## RELIABLE, INNOVATIVE PRODUCTS

### Omron Maximizes the Investment in Automation and Safety

Omron products are specifically designed for simple programming, operation and maintenance, as well as long service life so machine builders and end customers benefit from a low cost of ownership over a machine's life cycle.



### Interconnection

Network configuration tool software, block I/O, junction slaves, switching hubs, wireless LAN, wiring and relay terminals, connection media



### Sensing

Inductive Proximity, Photoelectric, Fiber-Optic, Capacitive, Vision, Displacement and Profiling Sensors



### Control

Machine Automation Controllers, PLCs, Motion Controllers, Temperature and Process Controllers, Power Supplies, Timers, Counters, Software



### Visualization

Operator Interface Terminals (HMIs), Digital Panel Meters, Pilot Lights



### Actuation

Servomotors and Servo Drives, AC Drives (Frequency Inverters), Limit Switches, Basic Switches, Pushbutton and Selector Switches, Solid State and Electromechanical Relays

## WORKS AS DESIGNED, DELIVERS AS PROMISED

*“Omron brings a depth of knowledge and experience with engineers who provide comprehensive solutions for every project that comes to us. Because each project is unique, this is an extremely valuable capability.”*

Christopher Alan, founder and president, Dasher/Lawless and creator of the Auto ParkIt automated parking facility for retail, commercial, and residential developments.

### Support From Your First Idea to Your Final Machine

Let Omron introduce you to talented systems integrators, custom machine designers, field application engineers and technical support providers to help you design or retrofit your machine for greater productivity. When it is ready to deliver, we can assist with installation and commissioning. We are here to help you every step of the way.

### Application Engineering Services: 800-556-6766

Our knowledgeable staff can provide advanced support and engineering services at regular hourly rates. Some examples of advanced technical support services include:

- Code examples, application review, and troubleshooting
- Software installation and configuration
- Network configuration assistance
- Program conversion services

### Area Technical Support Services: 800-556-6766

Our Technical Services group provides technical support, application assistance and product selection assistance. Troubleshooting support is free to our customers during normal business hours: from 8:00 AM to 5:00 PM CST.

### After-Hours Technical Support: 800-367-4584

After hours service is available for basic technical support for Omron products. A product support specialist will answer your call within 30 minutes to assist you. Contact Omron toll-free to schedule an onsite emergency service call.

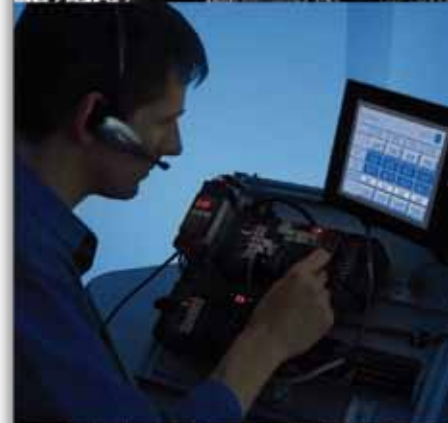

# Terms and Conditions of Sale

1. Offer; Acceptance. These terms and conditions (these "Terms") are deemed part of all quotes, agreements, purchase orders, acknowledgments, price lists, catalogs, manuals, brochures and other documents, whether electronic or in writing, relating to the sale of products or services (collectively, the "Products") by Omron Electronics LLC and its subsidiary companies ("Omron"). Omron objects to any terms or conditions proposed in Buyer's purchase order or other documents which are inconsistent with, or in addition to, these Terms.

2. Prices; Payment Terms. All prices stated are current, subject to change without notice by Omron. Omron reserves the right to increase or decrease prices on any unshipped portions of outstanding orders. Payments for Products are due net 30 days unless otherwise stated in the invoice.

3. Discounts. Cash discounts, if any, will apply only on the net amount of invoices sent to Buyer after deducting transportation charges, taxes and duties, and will be allowed only if (i) the invoice is paid according to Omron's payment terms and (ii) Buyer has no past due amounts.

4. Interest. Omron, at its option, may charge Buyer 1-1/2% interest per month or the maximum legal rate, whichever is less, on any balance not paid within the stated terms.

5. Orders. Omron will accept no order less than \$200 net billing.

6. Governmental Approvals. Buyer shall be responsible for, and shall bear all costs involved in, obtaining any government approvals required for the importation or sale of the Products.

7. Taxes. All taxes, duties and other governmental charges (other than general real property and income taxes), including any interest or penalties thereon, imposed directly or indirectly on Omron or required to be collected directly or indirectly by Omron for the manufacture, production, sale, delivery, importation, consumption or use of the Products sold hereunder (including customs duties and sales, excise, use, turnover and license taxes) shall be charged to and remitted by Buyer to Omron.

8. Financial. If the financial position of Buyer at any time becomes unsatisfactory to Omron, Omron reserves the right to stop shipments or require satisfactory security or payment in advance. If Buyer fails to make payment or otherwise comply with these Terms or any related agreement, Omron may (without liability and in addition to other remedies) cancel any unshipped portion of Products sold hereunder and stop any Products in transit until Buyer pays all amounts, including amounts payable hereunder, whether or not then due, which are owing to it by Buyer. Buyer shall in any event remain liable for all unpaid accounts.

9. Cancellation; Etc. Orders are not subject to rescheduling or cancellation unless Buyer indemnifies Omron against all related costs or expenses.

10. Force Majeure. Omron shall not be liable for any delay or failure in delivery resulting from causes beyond its control, including earthquakes, fires, floods, strikes or other labor disputes, shortage of labor or materials, accidents to machinery, acts of sabotage, riots, delay in or lack of transportation or the requirements of any government authority.

11. Shipping; Delivery. Unless otherwise expressly agreed in writing by Omron:

- Shipments shall be by a carrier selected by Omron; Omron will not drop ship except in "break down" situations.
- Such carrier shall act as the agent of Buyer and delivery to such carrier shall constitute delivery to Buyer;
- All sales and shipments of Products shall be FOB shipping point (unless otherwise stated in writing by Omron), at which point title and risk of loss shall pass from Omron to Buyer; provided that Omron shall retain a security interest in the Products until the full purchase price is paid;
- Delivery and shipping dates are estimates only; and
- Omron will package Products as it deems proper for protection against normal handling and extra charges apply to special conditions.

12. Claims. Any claim by Buyer against Omron for shortage or damage to the Products occurring before delivery to the carrier must be presented in writing to Omron within 30 days of receipt of shipment and include the original transportation bill signed by the carrier noting that the carrier received the Products from Omron in the condition claimed.

13. Warranties. (a) Exclusive Warranty. Omron's exclusive warranty is that the Products will be free from defects in materials and workmanship for a period of twelve months from the date of sale by Omron (or such other period expressed in writing by Omron). Omron disclaims all other warranties, express or implied.

(b) Limitations. OMRON MAKES NO WARRANTY OR REPRESENTATION, EXPRESS OR IMPLIED, ABOUT NON-INFRINGEMENT, MERCHANTABILITY OR FITNESS FOR A PARTICULAR PURPOSE OF THE PRODUCTS.

BUYER ACKNOWLEDGES THAT IT ALONE HAS DETERMINED THAT THE

PRODUCTS WILL SUITABLY MEET THE REQUIREMENTS OF THEIR INTENDED USE. Omron further disclaims all warranties and responsibility of any type for claims or expenses based on infringement by the Products or otherwise of any intellectual property right. (c) Buyer Remedy. Omron's sole obligation hereunder shall be, at Omron's election, to (i) replace (in the form originally shipped with Buyer responsible for labor charges for removal or replacement thereof) the non-complying Product, (ii) repair the non-complying Product, or (iii) repay or credit Buyer an amount equal to the purchase price of the non-complying Product; provided that in no event shall Omron be responsible for warranty, repair, indemnity or any other claims or expenses regarding the Products unless Omron's analysis confirms that the Products were properly handled, stored, installed and maintained and not subject to contamination, abuse, misuse or inappropriate modification. Return of any Products by Buyer must be approved in writing by Omron before shipment. Omron Companies shall not be liable for the suitability or unsuitability or the results from the use of Products in combination with any electrical or electronic components, circuits, system assemblies or any other materials or substances or environments.

Any advice, recommendations or information given orally or in writing, are not to be construed as an amendment or addition to the above warranty. See <http://www.omron247.com> or contact your Omron representative for published information.

14. Limitation on Liability; Etc. OMRON COMPANIES SHALL NOT BE LIABLE FOR SPECIAL, INDIRECT, INCIDENTAL, OR CONSEQUENTIAL DAMAGES, LOSS OF PROFITS OR PRODUCTION OR COMMERCIAL LOSS IN ANY WAY CONNECTED WITH THE PRODUCTS, WHETHER SUCH CLAIM IS BASED IN CONTRACT, WARRANTY, NEGLIGENCE OR STRICT LIABILITY. Further, in no event shall liability of Omron Companies exceed the individual price of the Product on which liability is asserted.

15. Indemnities. Buyer shall indemnify and hold harmless Omron Companies and their employees from and against all liabilities, losses, claims, costs and expenses (including attorney's fees and expenses) related to any claim, investigation, litigation or proceeding (whether or not Omron is a party) which arises or is alleged to arise from Buyer's acts or omissions under these Terms or in any way with respect to the Products. Without limiting the foregoing, Buyer (at its own expense) shall indemnify and hold harmless Omron and defend or settle any action brought against such Companies to the extent based on a claim that any Product made to Buyer specifications infringed intellectual property rights of another party.

16. Property; Confidentiality. Any intellectual property in the Products is the exclusive property of Omron Companies and Buyer shall not attempt to duplicate it in any way without the written permission of Omron. Notwithstanding any charges to Buyer for engineering or tooling, all engineering and tooling shall remain the exclusive property of Omron. All information and materials supplied by Omron to Buyer relating to the Products are confidential and proprietary, and Buyer shall limit distribution thereof to its trusted employees and strictly prevent disclosure to any third party.

17. Export Controls. Buyer shall comply with all applicable laws, regulations and licenses regarding (i) export of products or information; (iii) sale of products to "forbidden" or other proscribed persons; and (ii) disclosure to non-citizens of regulated technology or information.

18. Miscellaneous. (a) Waiver. No failure or delay by Omron in exercising any right and no course of dealing between Buyer and Omron shall operate as a waiver of rights by Omron.

(b) Assignment. Buyer may not assign its rights hereunder without Omron's written consent.

(c) Law. These Terms are governed by the law of the jurisdiction of the home office of the Omron company from which Buyer is purchasing the Products (without regard to conflict of law principles).

(d) Amendment. These Terms constitute the entire agreement between Buyer and Omron relating to the Products, and no provision may be changed or waived unless in writing signed by the parties.

(e) Severability. If any provision hereof is rendered ineffective or invalid, such provision shall not invalidate any other provision.

(f) Setoff. Buyer shall have no right to set off any amounts against the amount owing in respect of this invoice.

(g) Definitions. As used herein, "including" means "including without limitation"; and "Omron Companies" (or similar words) mean Omron Corporation and any direct or indirect subsidiary or affiliate thereof.

## Certain Precautions on Specifications and Use

1. Suitability of Use. Omron Companies shall not be responsible for conformity with any standards, codes or regulations which apply to the combination of the Product in the Buyer's application or use of the Product. At Buyer's request, Omron will provide applicable third party certification documents identifying ratings and limitations of use which apply to the Product. This information by itself is not sufficient for a complete determination of the suitability of the Product in combination with the end product, machine, system, or other application or use. Buyer shall be solely responsible for determining appropriateness of the particular Product with respect to Buyer's application, product or system. Buyer shall take application responsibility in all cases but the following is a non-exhaustive list of applications for which particular attention must be given: (i) Outdoor use, uses involving potential chemical contamination or electrical interference, or conditions or uses not described in this document.

(ii) Use in consumer products or any use in significant quantities.

(iii) Energy control systems, combustion systems, railroad systems, aviation systems, medical equipment, amusement machines, vehicles, safety equipment, and installations subject to separate industry or government regulations.

(iv) Systems, machines and equipment that could present a risk to life or property. Please know and observe all prohibitions of use applicable to this Product.

**NEVER USE THE PRODUCT FOR AN APPLICATION INVOLVING SERIOUS RISK TO LIFE OR PROPERTY OR IN LARGE QUANTITIES WITHOUT ENSURING THAT THE SYSTEM AS A WHOLE HAS BEEN DESIGNED TO ADDRESS THE RISKS, AND THAT THE OMRON'S PRODUCT IS PROPERLY**

**RATED AND INSTALLED FOR THE INTENDED USE WITHIN THE OVERALL EQUIPMENT OR SYSTEM.**

2. Programmable Products. Omron Companies shall not be responsible for the user's programming of a programmable Product, or any consequence thereof.

3. Performance Data. Data presented in Omron Company websites, catalogs and other materials is provided as a guide for the user in determining suitability and does not constitute a warranty. It may represent the result of Omron's test conditions, and the user must correlate it to actual application requirements. Actual performance is subject to the Omron's Warranty and Limitations of Liability.

4. Change in Specifications. Product specifications and accessories may be changed at any time based on improvements and other reasons. It is our practice to change part numbers when published ratings or features are changed, or when significant construction changes are made. However, some specifications of the Product may be changed without any notice. When in doubt, special part numbers may be assigned to fix or establish key specifications for your application. Please consult with your Omron's representative at any time to confirm actual specifications of purchased Product.

5. Errors and Omissions. Information presented by Omron Companies has been checked and is believed to be accurate; however, no responsibility is assumed for clerical, typographical or proofreading errors or omissions.



Contents		
<b>Selection Guide</b>		A-ii
<b>Machine Automation Controllers (MAC)</b>		
<b>Sysmac NJ-Series</b>	Logic and advanced motion control at the core	A-1
	Configuration	A-3
	CPUs, Power supplies & memory card	A-5
	Basic & special I/O units	A-6
	Sysmac Studio Software	A-7
	GX-JC EtherCAT junction slaves	A-8
	Industrial Ethernet media	A-9
	<b>Modular PLC</b>	
<b>CJ2-Series</b>	CPU units	A-10
	Power supplies, I/O Expansion	A-11
	Digital I/O units	A-12
	Analog I/O and control units	A-14
	Temperature control units	A-16
	Communication units	A-17
<b>Rack PLC</b>		
<b>CS1-Series</b>	CPU units	A-18
	Power supplies, backplanes	A-19
	Digital I/O units	A-20
	Analog and process I/O units	A-21
	Communication units	A-23

<b>Micro PLCs</b>		
<b>CP1H</b>	CPU units	A-24
<b>CP1L</b>	CPU units	A-25
<b>CP1E</b>	CPU units	A-26
<b>CP1W/CPM1A</b>	Expansion units, options for CPU units	A-28
<b>CPM2C</b>	CPU units / Expansion units	A-30
<b>Programmable Relays</b>		
<b>ZEN</b>	CPU Units / Expansion Units	A-31

## KNOW ONE... KNOW THEM ALL!

Whether your automation requires a simple and economical solution or your target is advanced, high-speed machine control, you can find what you need in Omron's line-up of Programmable Controllers.

And if your systems grow, or change due to market demand, you will find that only Omron offers a full range of Micro PLCs and Modular PLCs that share the same architecture. Therefore your programs are fully upward compatible, both in memory allocation and instruction set.

- One scalable PLC family to always match exactly with your application
- Transparent communication routing through different networks
- The best size/performance ratio in the industry

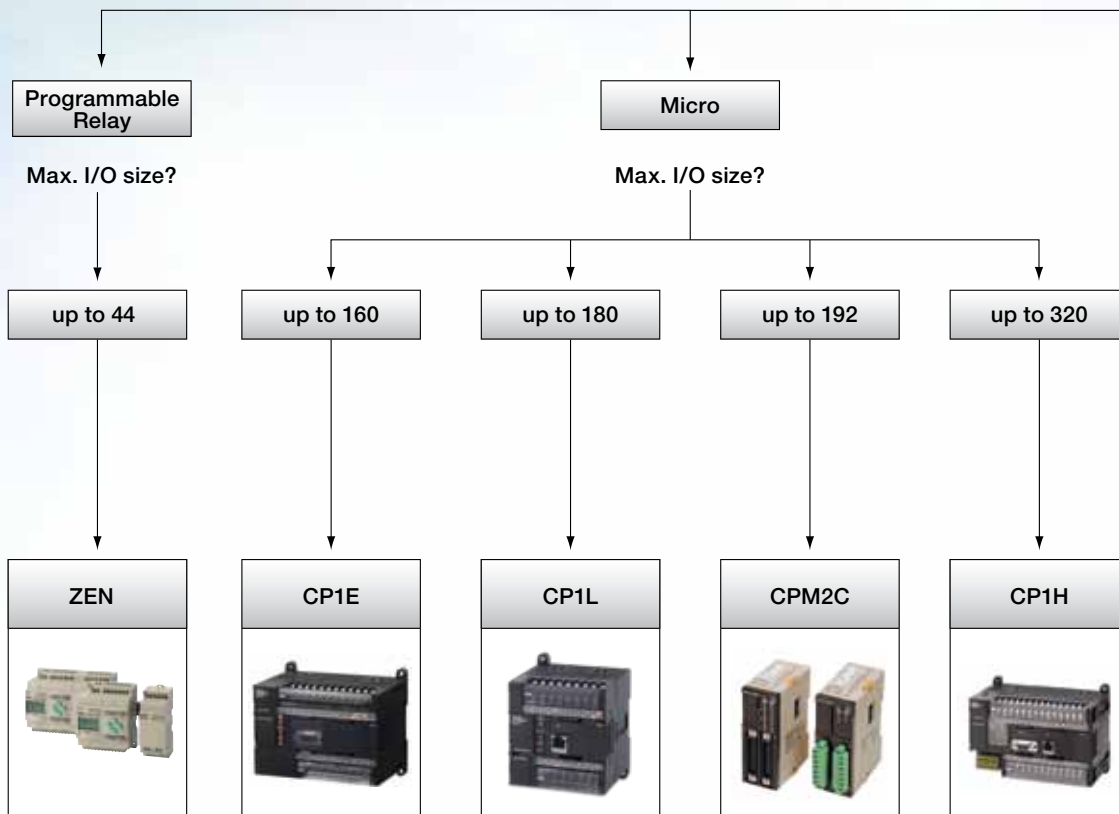



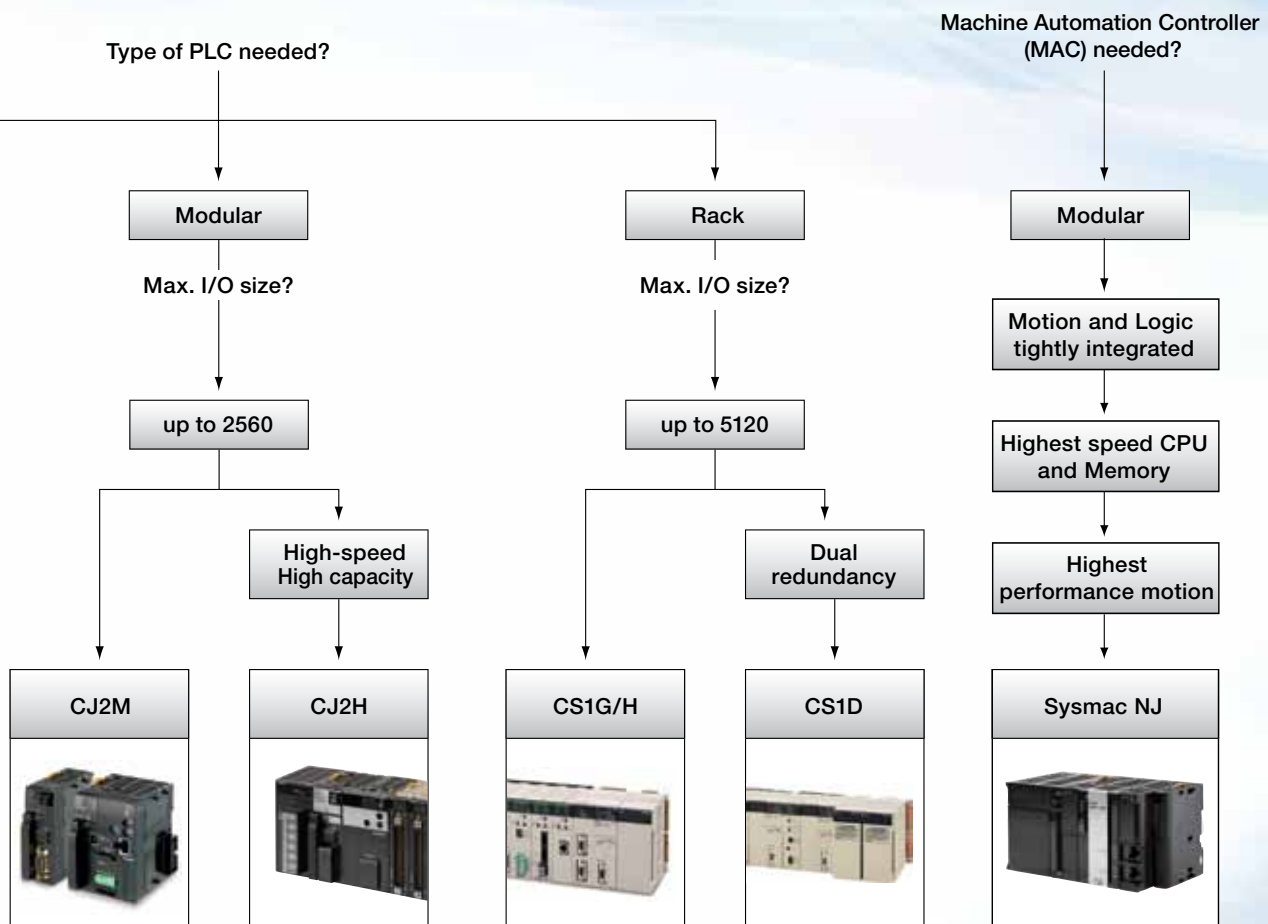

## MOTION, LOGIC, AND VISION IN ONE CONTROLLER

If your application demands a level of integration and performance beyond traditional PLCs or stand-alone controller capabilities, then the Sysmac Machine Automation Controller (MAC) is the best choice. Omron's Sysmac NJ-Series MAC integrates motion, logic, and vision into one without sacrificing performance to meet X-Stream Machine Control requirements.

The Sysmac Studio software was developed specifically for the NJ-Series hardware platform to be a truly Integrated Development Environment (IDE) all in one. The controls engineer has one connection to the machine to simplify setup, efficiently program and centrally maintain. One controller, one software, one connection.





# Selection Table

		Programmable Relays	Micro PLC Series		
					
Model		ZEN	CPM2C	CP1E	CP1L
Max digital I/O points*1		44	192	160	180
Built-in	Digital I/O	10 or 20	10 to 32	10 to 60	10 to 60
	Interrupt inputs	0	2 or 4	4 or 6	2, 4, or 6
	High-speed Counter inputs	1	2 or 4	5 or 6	4
	Pulse outputs*1	0	2	2	2
CPU features*1		<ul style="list-style-type: none"> <li>• 4 line x 12 character LCD display</li> <li>• High speed counter (150 Hz)</li> <li>• Twin timer</li> <li>• Weekly and calendar timers</li> <li>• Analog input comparators</li> <li>• Slim 8 I/O expansion units</li> <li>• RS-485 serial communication</li> <li>• ZEN Support Software offers simulation capability, ladder programming, parameter setting, monitoring and printing in a Windows environment</li> </ul>	<ul style="list-style-type: none"> <li>• Compact size</li> <li>• Expansion units</li> <li>• Quick-response inputs</li> <li>• Input interrupts</li> <li>• High-speed counter</li> <li>• Pulse output with PWM</li> <li>• Built-in RS-232C port</li> <li>• Real time clock</li> </ul>	<ul style="list-style-type: none"> <li>• USB port standard</li> <li>• Expansion I/O units</li> <li>• Quick-response inputs</li> <li>• Input interrupts</li> <li>• High-speed counter</li> <li>• Pulse output w/ PWM</li> <li>• Built-in RS-232C port</li> <li>• Serial option boards</li> <li>• Real time clock</li> <li>• 2 Analog adjusters</li> </ul>	<ul style="list-style-type: none"> <li>• USB port standard</li> <li>• Expansion I/O units</li> <li>• Quick-response inputs</li> <li>• Input interrupts</li> <li>• High-speed counter</li> <li>• Pulse output with PWM</li> <li>• Built-in RS-232C port</li> <li>• Option board slots</li> <li>• Real time clock</li> <li>• 1 Analog adjuster</li> <li>• 1 External analog input</li> </ul>
Instruction Execution time (bit instruction)			0.64 µs	1.10 µs	0.61 µs
Program memory		96 lines	4K words	2 or 8K steps	5 or 10K steps
Data memory		–	2K words	2 or 8K words	10 or 32K words
External memory		–	Expansion memory unit	–	Memory cassette
Analog I/O		<ul style="list-style-type: none"> <li>• 2 analog voltage inputs , 0-10 V (DC only)</li> </ul>	<ul style="list-style-type: none"> <li>• Analog I/O unit</li> <li>• Temperature sensor unit</li> </ul>	<ul style="list-style-type: none"> <li>• Built-in for E-NA model (2 in + 1 out)</li> <li>• Analog I/O Expansion Units</li> <li>• Temperature Input Expansion Units</li> </ul>	<ul style="list-style-type: none"> <li>• Analog I/O Expansion Units</li> <li>• Temperature Input Expansion Units</li> </ul>
Special function units		–			
Fieldbus master		–			
Fieldbus I/O		<ul style="list-style-type: none"> <li>• N/A</li> </ul>	<ul style="list-style-type: none"> <li>• CompoBus/S</li> <li>• DeviceNet</li> </ul>	<ul style="list-style-type: none"> <li>• PROFIBUS-DP</li> <li>• CompoBus/S</li> <li>• DeviceNet</li> </ul>	<ul style="list-style-type: none"> <li>• PROFIBUS-DP</li> <li>• CompoBus/S</li> <li>• DeviceNet</li> </ul>

\*1 Some features listed are not available for all CPU types within each series. Please review specifications for more information on CPU features and performance.  
 \*2 Represents local I/O capacity. If a fieldbus master is used more I/O is possible.



# Programmable Controllers

A

		Micro PLC series	Modular PLC series	
				
Model		CP1H	CJ2M	CJ2H
Max digital I/O points <sup>1</sup>		320 <sup>2</sup>	2560	2560
Built-in	Digital I/O	20 or 40	-	
	Interrupt inputs	6 or 8	-	
	Counter inputs	4	-	
	Pulse outputs	4	-	
CPU features <sup>1</sup>		<ul style="list-style-type: none"> <li>• USB port standard</li> <li>• Expansion I/O units</li> <li>• CJ-series Special I/O Units</li> <li>• CJ-series CPU Bus Units</li> <li>• Quick-response inputs</li> <li>• Input interrupts</li> <li>• High-speed counter</li> <li>• Pulse output with PWM</li> <li>• Built-in RS-232C port</li> <li>• Option board slots</li> <li>• Real time clock</li> <li>• 1 Analog adjuster</li> <li>• 1 External analog input</li> <li>• LED display, 2 digit</li> </ul>	<ul style="list-style-type: none"> <li>• USB port standard</li> <li>• Built-in Ethernet/IP port</li> <li>• High-speed I/O units</li> <li>• Option board plug-in</li> <li>• Structures and arrays</li> <li>• Tag data links</li> <li>• Compact size</li> <li>• No backplane required</li> <li>• Large program capacity</li> <li>• Function Block memory</li> <li>• Easy backups</li> <li>• Real time clock</li> </ul>	<ul style="list-style-type: none"> <li>• USB port standard</li> <li>• Built-in Ethernet/IP port</li> <li>• High-speed I/O units</li> <li>• Structures and arrays</li> <li>• Tag data links</li> <li>• Synchronous I/O</li> <li>• Compact size</li> <li>• No backplane required</li> <li>• Extra Large program capacity</li> <li>• Easy backups</li> <li>• Real time clock</li> </ul>
Instruction Execution time (bit instruction)		0.10 µs	0.04 µs	0.016 µs
Program memory		20K steps	5 to 60K steps	50 to 400K steps
Data memory		32K words	64 to 160K words	160 to 832K words
External memory		Memory cassette	Up to 512 MB	
Analog I/O		<ul style="list-style-type: none"> <li>• Built-in for XA model (4 in + 2 out)</li> <li>• Analog I/O Expansion Units</li> <li>• Temperature Input Expansion Units</li> <li>• CJ Analog I/O Units</li> <li>• CJ Temperature Units</li> </ul>	<ul style="list-style-type: none"> <li>• Analog I/O unit</li> <li>• Temperature control unit</li> </ul>	
Special function units		<ul style="list-style-type: none"> <li>• CJ-series Special I/O Units</li> <li>• CJ-series CPU Bus Units</li> </ul>	<ul style="list-style-type: none"> <li>• Temperature control</li> <li>• High-speed counters (500 kHz)</li> <li>• SSI encoder input</li> <li>• Position control</li> <li>• Protocol macro</li> <li>• RFID sensor unit</li> </ul>	<ul style="list-style-type: none"> <li>• Temperature control</li> <li>• High-speed counters (500 kHz)</li> <li>• SSI encoder input</li> <li>• Position control</li> <li>• Protocol macro</li> <li>• RFID sensor unit</li> <li>• High-speed I/O</li> <li>• Synchronised Position</li> </ul>
Fieldbus master		<ul style="list-style-type: none"> <li>• Ethernet</li> <li>• EtherNet/IP</li> <li>• Controller Link</li> <li>• DeviceNet</li> <li>• PROFIBUS-DP</li> <li>• PROFINET</li> <li>• ModBus</li> <li>• CompoNet</li> <li>• CompoBus/S</li> <li>• CAN (freely configurable)</li> </ul>		
Fieldbus I/O		<ul style="list-style-type: none"> <li>• PROFIBUS-DP</li> <li>• CompoBus/S</li> <li>• DeviceNet</li> </ul>	<ul style="list-style-type: none"> <li>• DeviceNet</li> <li>• PROFIBUS-DP</li> <li>• CAN (freely configurable)</li> </ul>	

<sup>1</sup> Some features listed are not available for all CPU types within each series. Please review specifications for more information on CPU features and performance.

# Selection Table

	Rack PLC series		Machine Automation Control - NJ Series	
				
Model	CS1G/H	CS1D	NJ3	NJ5
Max digital I/O points <sup>1</sup>	5120	5120	2560 points max., plus EtherCAT slave I/O capacity	
CPU features <sup>1</sup>	<ul style="list-style-type: none"> <li>• High I/O capacity</li> <li>• Inner board support</li> <li>• Large program capacity</li> <li>• Backwards compatible</li> <li>• Easy backups</li> <li>• Real time clock</li> </ul>	<ul style="list-style-type: none"> <li>• Redundant CPU</li> <li>• Redundant power supply</li> <li>• Hot swapping</li> <li>• High I/O capacity</li> <li>• Inner board support</li> <li>• Large program capacity</li> <li>• Backwards compatible</li> <li>• Easy backups</li> <li>• Real time clock</li> </ul>	<ul style="list-style-type: none"> <li>• Logic and motion in one controller</li> <li>• Scalable CPU's for up to 64 axis of coordinated motion control</li> <li>• Built-in EtherCAT realtime machine network (192 connections)</li> <li>• Built-in EtherNet/IP information network (32 connections)</li> <li>• IEC 61131-3 programming with object structures swaps</li> <li>• Certified PLCOpen Function Block for Motion Control</li> <li>• 3-D arrays</li> <li>• 3 expansion units, up to 40 connectable function units</li> <li>• Easy backups</li> <li>• Real-time clock</li> <li>• Real-time operating system with RAS functions</li> </ul>	
CPU Speed	–	–	600 MHz	1.6 GHz
Number of controlled axes	–	–	4, 8 axes	16, 32, and 64 axes
Instruction Execution time (bit instruction)	0.04/0.02 μs	0.04/0.02 μs	3.0 ns minimum	1.9 ns minimum
Program memory	10 to 250K steps	10 to 250K steps	5MB (100k steps)	20MB (400k steps)
Data memory (retained/non-retained)	64 to 448K words (retained)	64 to 448K words (retained)	0.5 / 2 MB	2 / 4 MB
External memory	Up to 512MB		2 GB SD card	
Analog I/O	• Temperature control unit		Analog I/O units, Isolated analog I/O	
Special function units	<ul style="list-style-type: none"> <li>• Temperature control</li> <li>• SSI encoder input</li> <li>• High-speed counters (500 kHz)</li> <li>• Position control</li> <li>• Motion control</li> <li>• Process control</li> <li>• Protocol macro</li> <li>• RFID sensor unit</li> </ul>		<ul style="list-style-type: none"> <li>• High-speed counter 500 kHz</li> <li>• Temperature controller</li> <li>• Protocol macro</li> <li>• RFID sensor control unit</li> <li>• High-speed I/O</li> <li>• Serial communications</li> </ul>	
Fieldbus master	<ul style="list-style-type: none"> <li>• Ethernet</li> <li>• EtherNet/IP</li> <li>• Controller Link</li> <li>• DeviceNet</li> <li>• PROFIBUS-DP</li> <li>• PROFINET</li> <li>• ModBus</li> <li>• CompoNet</li> <li>• CompoBus/S</li> <li>• CAN (freely configurable)</li> </ul>		<ul style="list-style-type: none"> <li>• DeviceNet</li> <li>• EtherNet/IP</li> <li>• PROFIBUS-DP</li> <li>• PROFINET</li> <li>• EtherCAT</li> <li>• CompoNet</li> </ul>	
Fieldbus I/O	<ul style="list-style-type: none"> <li>• DeviceNet</li> <li>• PROFIBUS-DP</li> <li>• CAN (freely configurable)</li> </ul>		<ul style="list-style-type: none"> <li>• DeviceNet</li> <li>• EtherNet/IP</li> <li>• CompoNet</li> </ul>	

Controller

Quick Link  
H237



## NJ-Series Machine Automation Controllers

- Integration of Motion, Logic and Vision in one controller
- Up to 64 axes motion control
- New PLC Logic and Motion cores, 100% Omron quality
- IEC 61131-3 programming languages
- EtherCAT and EtherNet/IP ports built in
- Certified PLCopen Function Blocks for Motion Control
- Reuse with most the CJ-Series I/O units

Servos and Inverters



Quick Link  
F354

### Accurax G5-Series Servo Drives

- Speed loop frequency response of 2 kHz
- Built-in safety conforming IEC61800-5-2 (STO), EN 954-1 (CAT3), EN61508 SIL2, and ISO13849-1 (PLC-d)
- High resolution serial encoder for greater accuracy provided by 20 bit encoder
- External encoder input for full closed loop
- Real time auto-tuning



Quick Link  
F356

### Accurax G5-Series Servo Motors

- Power range from 50 W to 15 kW
- IP67 protection
- Low cogging torque
- Peak torque 300% of rated torque for 3 seconds or more depending on model
- High resolution 20-bit encoder enables precise and accurate motor control



Quick Link  
D228

### MX2-Series AC Drives

- V/Hz or Sensorless vector control
- 200% starting torque at 0.5 Hz
- Double rating VT 120% for 1 min and CT 150% for 1 min
- Speed range up to 1000 Hz
- Torque control in open loop
- Simple positioning functionality
- Safety embedded compliant with ISO13849-1 (double input circuit and external device monitor EDM)

Vision Sensor



Quick Link  
G455

### FQ-M-Series Vision Sensors

- Camera, vision controller and network connectivity in one
- Compact vision sensor
- Designed for high-speed Pick and Place
- Encoder tracking and smart calibration function
- Fast and powerful object recognition

# Sysmac NJ Machine Automation Controllers (continued)

Distributed I/O



**Quick Link**  
**K246**

EtherCAT®

## GX-Series EtherCAT Remote I/O

- Wide variety of Block I/O: digital, analog and encoder I/O units
- Removable I/O terminal for easy servicing
- Easy set-up: automatic and manual address setting
- Real-time control synchronizes performance between slaves at 1 μs max
- Built-in 2-port Ethernet switch reduces costs by easily connecting to multiple blocks



**Quick Link**  
**K224**

## GRT1-Series SmartSlice I/O

- Diagnostics and preventive maintenance data at I/O level
- Detachable terminal blocks allow hot-swapping without rewiring
- 3-wire connection with “push-in” technology, no screwdriver required for installation
- Easy setup, backup and restore functions
- Expand up to 64 stations

Automation Software

## Sysmac Studio Software

**Quick Link**  
**L432**

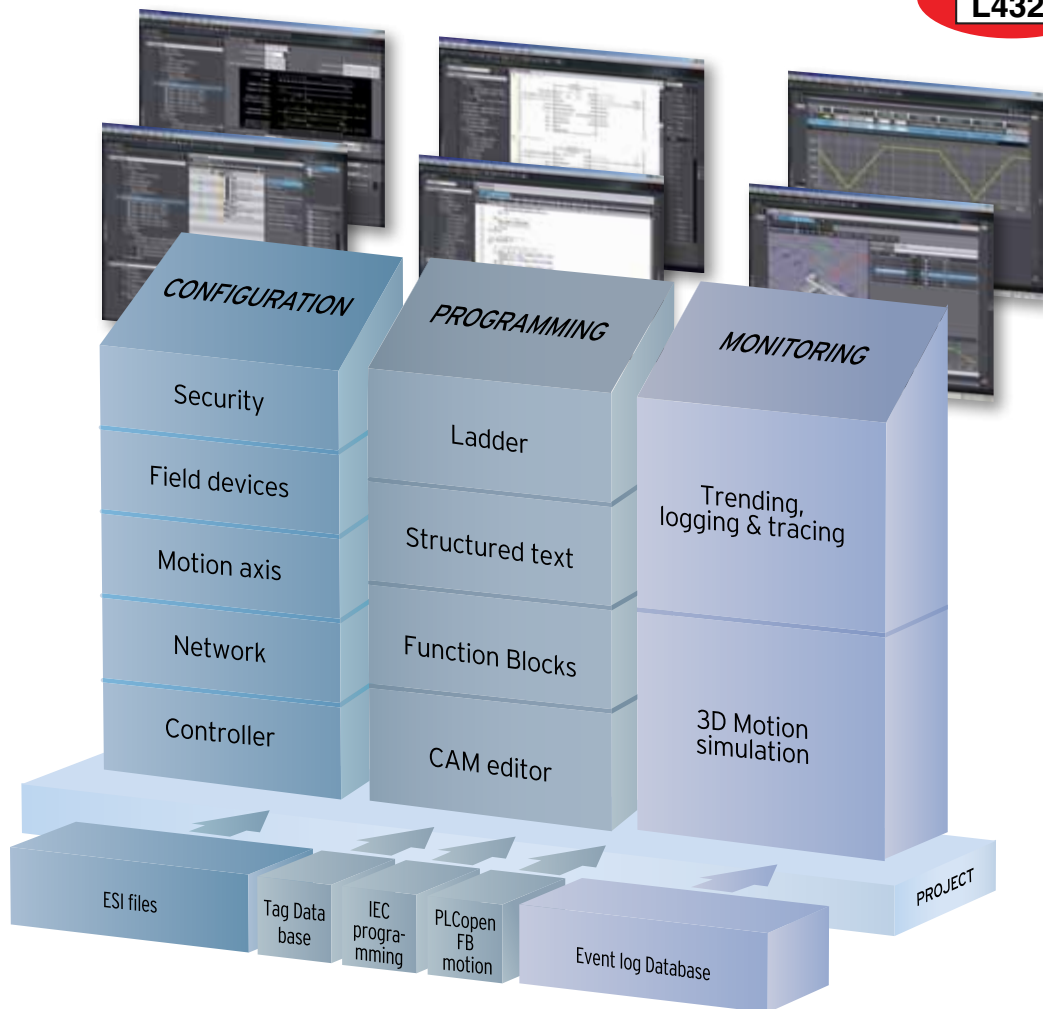



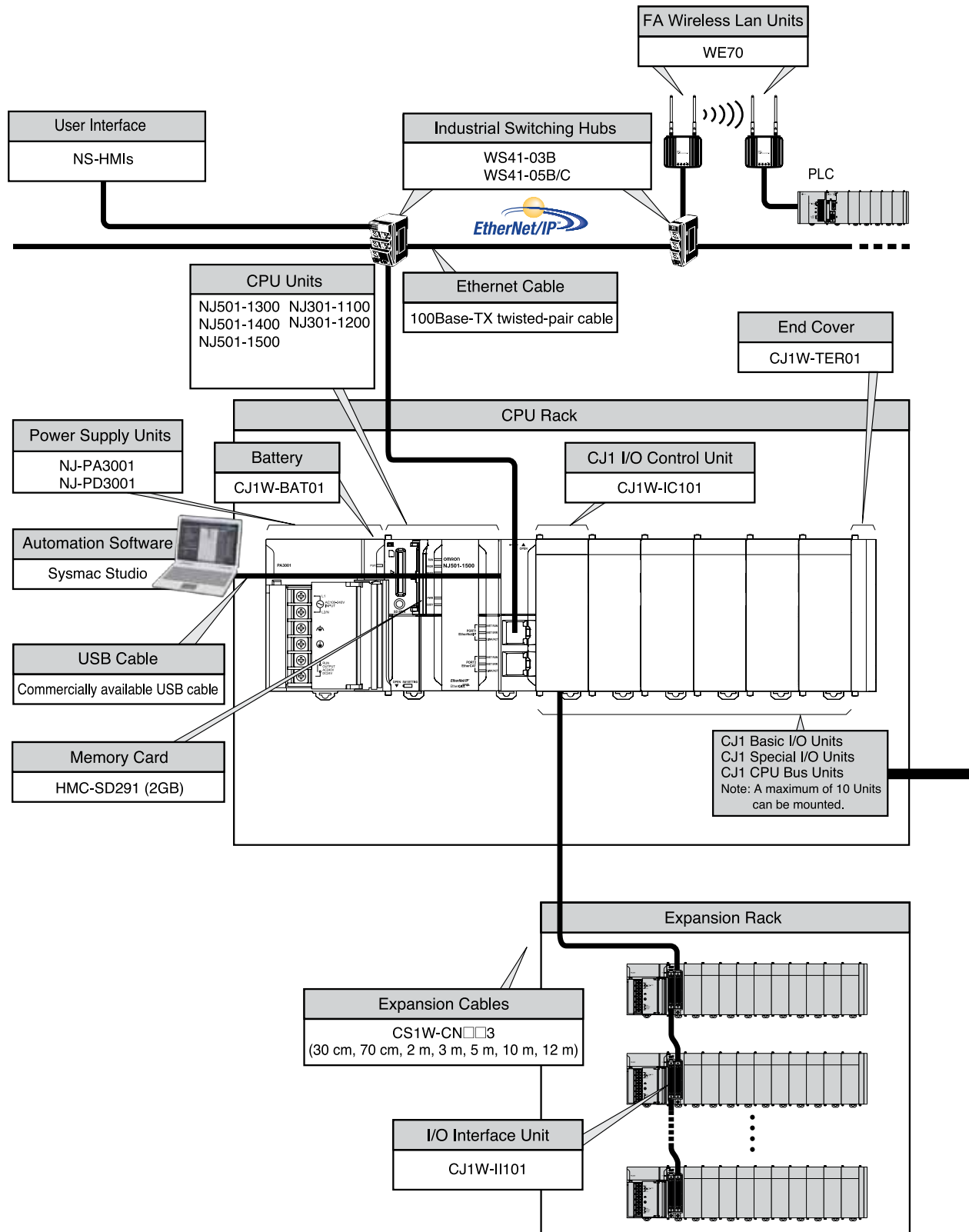

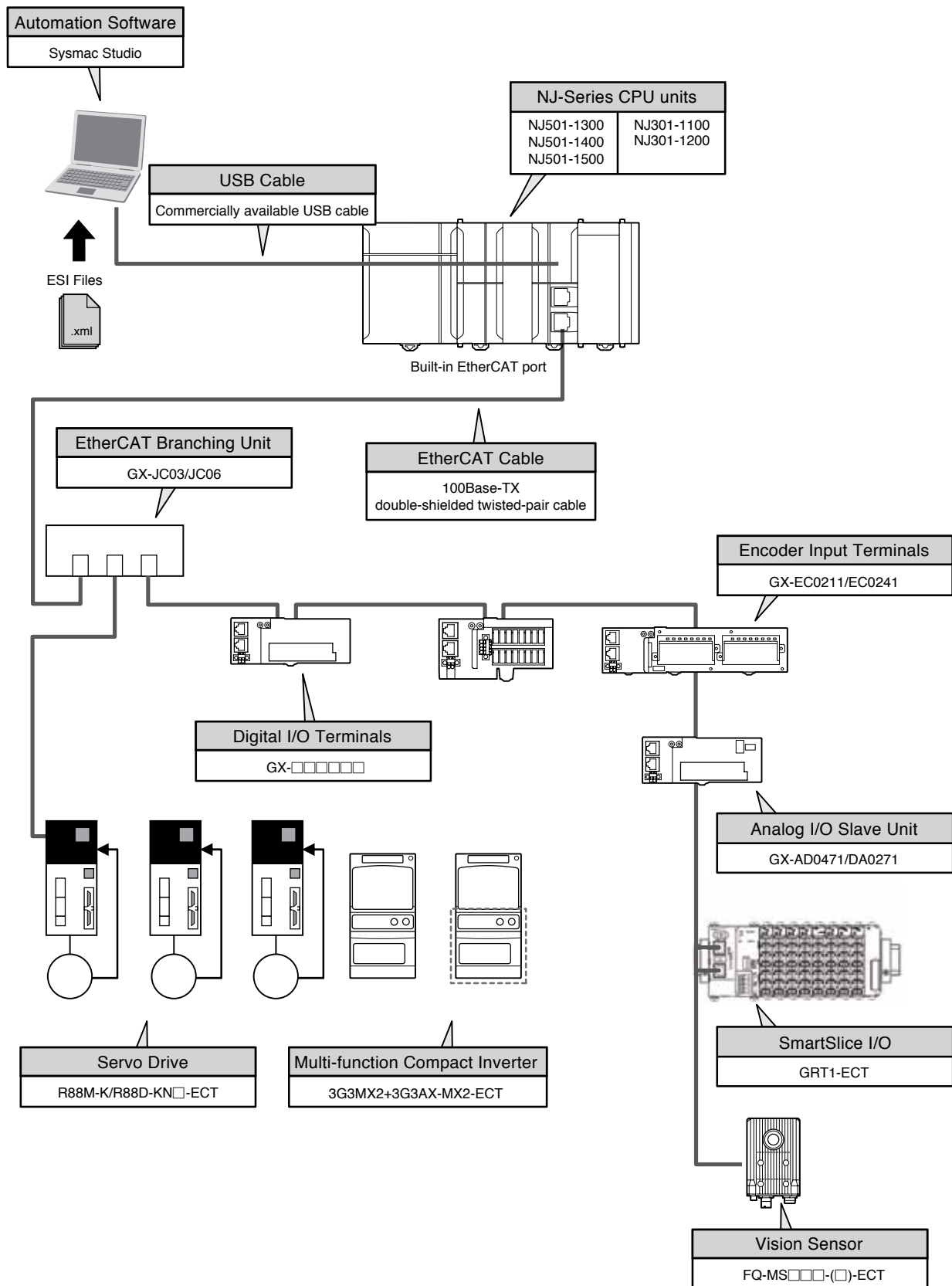

# NJ Series

## NJ501/301 Machine Automation Controller



A

### Complete and Robust Machine Automation



The NJ-Series is designed to meet extreme machine control requirements in terms of motion control speed and accuracy, communication, security and robustness.



- Up to 64 axes motion control
- EtherCAT and EtherNet/IP ports embedded
- Architecture based on new Intel CPU (600 MHz and 1.6 GHz)
- Standard IEC 61131-3 programming
- Certified PLCopen function blocks for motion control with parts 1, 2, 4

- Linear, circular, and helical\* interpolation (\*available soon)
- Power supplies available for AC and DC voltage
- Store data on 2GB SD memory card

### Sysmac NJ CPUs

Description	Program capacity	I/O capacity	Maximum number of units	Flash memory port	Built-in network ports	Motion control axes	Model
CPU Unit	5 MB	2,560 points max. plus EtherCAT slave I/O capacity	10 per CPU or expansion rack; 40 total per CPU	Yes	EtherCAT, EtherNet/IP	4	NJ301-1100
	20 MB					8	NJ301-1200
						16	NJ501-1300
						32	NJ501-1400
						64	NJ501-1500

### Power Supplies

Description	Input supply voltage	Output current		Output capacity	Built-in feature	Model
		5 VDC	24 VDC			
AC power supply unit	100 to 240 VAC	6.0 A	1.0 A	30 W	RUN output	NJ-PA3001
DC power supply unit	24 VDC					NJ-PD3001

### SD Memory Card

Description	Specifications	Model
SD memory card	Flash memory 2 GB	HMC-SD291

## Basic and Special I/O Units

CJ-Series I/O units serve as the Sysmac NJ MACs interface to achieve fast, reliable sequence control. From high-speed DC inputs to relay outputs, you can easily configure NJ-Series controllers to your needs.



### Basic I/O Units

Points	8-point units	16-point units	32-point units	64-point units
Input units	DC: CJ1W-ID201 AC: CJ1W-IA201	DC: CJ1W-ID211 CJ1W-ID212 (high-speed) AC: CJ1W-IA111	DC: CJ1W-ID231 CJ1W-ID232 CJ1W-ID233 (high speed)	DC: CJ1W-ID261 CJ1W-ID262
Output units	Relay contact (independent commons): CJ1W-OC201 Triac: CJ1W-OA201 Transistor: CJ1W-OD201 CJ1W-OD202 CJ1W-OD203 CJ1W-OD204	Relay contact: CJ1W-OC211 Transistor: CJ1W-OD211 CJ1W-OD212 CJ1W-OD213 (high speed)	Transistor: CJ1W-OD231 CJ1W-OD232 CJ1W-OD233 CJ1W-OD234 (high speed)	Transistor: CJ1W-OD261 CJ1W-OD262 CJ1W-OD263
Mixed I/O units	--	--	16 DC inputs, 16 transistor outputs: CJ1W-MD231 CJ1W-MD23 CJ1W-MD233	32 DC inputs, 32 transistor outputs: CJ1W-MD261 CJ1W-MD263 32 DC inputs, TTL outputs: CJ1W-MD563
Other units	--	Quick response input: CJ1W-IDP01	--	--

### Special I/O and CPU Bus Units

Process	Positioning	Communications	RFID Tracking
Universal inputs, isolated outputs: CJ1W-PH41U CJ1W-AD04U	High-speed counter: CJ1W-CT021, CJ1W-CTL41-E	Serial (high speed): CJ1W-SCU22, CJ1W-SCU32 CJ1W-SCU42	Control 1 antenna: CJ1W-V680C1 Control 2 antennas: CJ1W-V680C2
Isolated DC input: CJ1W-PDC15		DeviceNet: CJ1W-DRM21 EtherNet/IP: CJ1W-EIP21 PROFIBUS-DP: CJ1W-PRM21 PROFINET-IO: CJ1W-PNT21 RS-422A converter: CJ1W-CIF11	
Analog input: 4-point: CJ1W-AD042 (high speed) CJ1W-AD041-V1 8-point: CJ1W-AD081-V1			
Analog output: 4-point CJ1W-DA042V (high speed) 8-point: CJ1W-DA08V, CJ1W-DA08C 4-point: CJ1W-DA041 2-point: CJ1W-DA021			
Analog I/O: 4 inputs, 2 outputs: CJ1W-MAD42			
Temperature controller: CJ1W-TC003, CJ1W-TC004, CJ1W-TC103, CJ1W-TC104, CJ1W-TS561, CJ1W-TS562			

### Sysmac Studio for Machine Creators

The Sysmac Studio true Integrated Development Environment (IDE), part of the Sysmac Studio Automation Software Suite, provides a single operating environment to setup, program, debug, and maintain an entire SYSMAC NJ-Series machine solution.

- One software for configuration, logic, motion, vision, drives, networks, and I/O
- Open programming standards with IEC61131-3 Ladder and ST, as well as extensive PLCopen motion Function Blocks, all within a true tag-based environment
- Integrated 3D motion simulation tool and simulation video export with no hardware required
- Graphical CAM editor for easy programming of complex motion profiles
- Online AutoUpdates upgrade Sysmac Studio features and functionality FREE of charge



A

### PC System Requirements

OS	CPU		RAM	Display
Windows XP SP3 Windows Vista Windows 7 (32-bit or 64-bit edition)	Minimum	IBM AT or compatible with Celeron 540 (1.8 GHz) processor	2 GB	XGA 1,024 x 768, 16 million colors
	Recommended	IBM AT or compatible with Core i5 M520 (2.4 GHz) processor or the equivalent	2 GB	WXGA 1,280 x 800, 16 million colors

### Ordering Information

Number of users	License and Media model		License Only	DVD Only
	DVDs	Model	Model	Model
1	1	SYSMAC-STUDIO-1USER	SYSMAC-SE201L	SYSMAC-SE200D
3	1	SYSMAC-STUDIO-3USER	SYSMAC-SE203L	
10	3	SYSMAC-STUDIO-10USER	SYSMAC-SE210L	
30	10	SYSMAC-STUDIO-30USER	SYSMAC-SE230L	
50	16	SYSMAC-STUDIO-50USER	SYSMAC-SE250L	
Site	20	SYSMAC-STUDIO-SITE	SYSMAC-SE2XXL	
Vision edition	1	SYSMAC-STUDIO-FQM	SYSMAC-VE201L	-

#### Notes:

- Part number provides Sysmac Studio Automation Software Suite, which includes additional CX common software components for compatible products; CX-Designer, Network Configurator, etc.
- Sysmac Studio is fully compatible with CX-One V4.22 or higher.
- Sysmac Studio DVD can be installed without a license for a 30-day full functionality trial. Licenses can be purchased and registered separately.
- Software must be registered online in order to use FREE Online AutoUpdates.

## Automation Software Suite Contents

Subject	Sysmac Studio	Description
Programming	Sysmac Studio	A true Integrated Development Environment for Logic, Motion, Vision, and Simulation. Also includes equivalent functionality to CX-Drive for AC Drives & Servos.
	CX-Designer	CX-Designer is used to create screen data for NS-series Programmable Terminals. Users can develop screens and operate machines more efficiently with over 1,000 standard functional objects, associated graphics, and advanced troubleshooting functions.
Networks	CX-Integrator & Network Configurator EtherNet/IP	CX-Integrator & Network Configurator EtherNet/IP allow for easy network setup. They enable monitoring of the connection status, setting parameters, and diagnostics.
	CX-ConfiguratorFDT	Based on FDT/DTM technology, CX-ConfiguratorFDT can be used to configure devices from any vendor connected to a PROFIBUS network.

## GX-JC EtherCAT Junction Slave

### Design Flexible Wiring Solutions

The GX-JC EtherCAT Junction Slaves provide the flexibility to use the most effective connection configuration for a wide range of applications.

- 3- and 6-port Junction Slaves are available for Daisy Chain, Star and Tree connections on EtherCAT networks
- Compact size
- Supply voltage range compensates for power voltage drop over long wiring distances
- Meets cULus Class I Division 2 rating for Products for Hazardous Locations



### EtherCAT Junction Slaves

Description	Number of ports	Power supply voltage	Dimensions (mm)	Current consumption	Model
EtherCAT junction slaves	3	20.4 to 28.8 VDC (24 VDC -15% to +20%)	25 W x 78 D x 90 H	0.08 A	GX-JC03
	6		48 W x 78 D x 90 H	0.17 A	GX-JC06

**Note:** Do not connect GX-JC EtherCAT junction slaves with Omron position control unit CJ1W-NC81 or CJ1W-NC82.

# XS5 Cordsets/XS6 Connectors

## Industrial Ethernet Media



A





### Supports EtherNet/IP, EtherCAT and Other Popular Networks Based on Ethernet

Omron offers a line of shielded high quality industrial cables for inside and outside the control panel.



- Cables are shielded to protect against EMI
- cULus approval markings on cable



### Ethernet Connector Cordsets

Appearance	Description	Cable length (m)	Model
	Cable with RJ45 connectors on both ends  Use with Sysmac NJ5 controllers, Accurax G5 servos (R88D-KN-ECT), 3G3MX2 AC drives with interface, GX EtherCAT Block I/O, GRT1-ECT SmartSlice I/O EtherCAT coupler, GX-JC EtherCAT Junction Slave	0.3	XS5W-T421-AMD-K
		0.5	XS5W-T421-BMD-K
		1	XS5W-T421-CMD-K
		2	XS5W-T421-DMD-K
		3	XS5W-T421-EMD-K
		5	XS5W-T421-GMD-K
		10	XS5W-T421-JMD-K
	Cable with M12 connector and RJ45 connector Use with FQ-M Vision Sensors, ERT1 EtherNet/IP Block I/O (IP67)	0.3	XS5W-T421-AMC-K
		0.5	XS5W-T421-BMC-K
		1	XS5W-T421-CMC-K
		2	XS5W-T421-DMC-K
		3	XS5W-T421-EMC-K
		5	XS5W-T421-GMC-K
		10	XS5W-T421-JMC-K
	Extension cable with M12 connectors on both ends	0.5	XS5W-T421-BM2-K
		1	XS5W-T421-CM2-K
		2	XS5W-T421-DM2-K
		3	XS5W-T421-EM2-K
		5	XS5W-T421-GM2-K
		10	XS5W-T421-JM2-K
		15	XS5W-T421-KM2-K
	Cable with M12 connector on one end and flying leads on the other	0.5	XS5W-T421-BM0-K
		1	XS5W-T421-CM0-K
		2	XS5W-T421-DM0-K
		3	XS5W-T421-EM0-K
		5	XS5W-T421-GM0-K
		10	XS5W-T421-JM0-K
		15	XS5W-T421-KM0-K

### Ethernet Connectors

Appearance	Description	Cable length (m)	Model
	RJ45 Assembly connector for on-site wiring	--	XS6G-T421-1
	Rear Locking M12 Connector for panel mounting	0.5	XS5P-T426-5
	Front Locking M12 Connector for Panel mounting	0.5	XS5P-T427-5

### Fast and Powerful CPUs for Any Task

All CPU units support IEC61131-3 Structured text, Sequential Function Charts and ladder language. Omron's extensive function block library helps to reduce your programming effort, while you can create your own function blocks to suit your specific needs.

The new CJ2 CPU units offer increased capacity, higher performance plus built-in USB and models with Ethernet ports. They are fully compatible with the extensive range of CJ1 I/O units.



### Ordering Information

Max digital I/O points	Program capacity	Data memory capacity	Logic execution speed	Max. I/O units	Width	5 V Current consumption	Built-in functions	Model
2,560	400 K	832 K	16 ns	40	80 mm	820 mA	USB + Ethernet/IP + RS-232C	CJ2H-CPU68-EIP
	250 K	512 K						CJ2H-CPU67-EIP
	150 K	352 K						CJ2H-CPU66-EIP
	100 K	160 K						CJ2H-CPU65-EIP
	50 K	160 K						CJ2H-CPU64-EIP
	60 K	160 K						40 ns
	30 K	160 K	CJ2M-CPU34					
	20 K	64 K	CJ2M-CPU33					
	10 K	64 K	CJ2M-CPU32					
	5 K	64 K	CJ2M-CPU31					
	60 K	160 K	31 mm		500 mA	USB + RS-232C	CJ2M-CPU15	
	30 K	160 K					CJ2M-CPU14	
	20 K	64 K					CJ2M-CPU13	
	10 K	64 K					CJ2M-CPU12	
	5 K	64 K					CJ2M-CPU11	

### Pulse I/O Modules (Only CJ2M CPU Unit with Unit Version 2.0 or Later)

Optional Pulse I/O Modules can be mounted to enable pulse I/O. Up to two Pulse I/O Modules can be mounted to the left side of a CJ2M CPU Unit.

Product name	Specifications	Current consumption (A)		Model	Standards
		5 V	24 V		
Pulse I/O Module	Sinking outputs, MIL connector 10 inputs (4 interrupt/quick response inputs, 2 high-speed counter inputs) 6 outputs (2 pulse outputs and 2 PWM outputs)	0.08	---	CJ2M-MD211 <b>NEW</b>	UC1, N, L, CE
	Sourcing outputs, MIL connector 10 inputs (4 interrupt/quick response inputs, 2 high-speed counter inputs) 6 outputs (2 pulse outputs, 2 PWM outputs)	0.08	---	CJ2M-MD212 <b>NEW</b>	

**Note:** Connectors are not provided with Pulse I/O Modules. Purchase the following Connector, an OMRON Cable with Connectors for Connector Terminal Block Conversion Units, or an OMRON Cable with Connectors for Servo Relay Units.



## Power and Flexibility

CJ systems can operate on 24 VDC power supply, or on 100 to 240 VAC. For small-scale systems with mainly digital I/O, a low cost, small capacity power supply can be used. For systems with many analog I/Os and control/communication units, it may be necessary to use a larger power supply unit.

Depending on the CPU type, up to three expansions can be connected to the CPU 'rack', giving a total capacity of 40 I/O units. The total length of the expansion cables of one system may be up to 12 m.



## Ordering Information

### Power Supply

Input range	Power consumption	Output capacity at 5 VDC	Output capacity at 24 VDC	Max. output power	Features	Width	Model
21.6 - 25.4 VDC	35 W max.	2.0 A	0.4 A	16.6 W	--	27 mm	CJ1W-PD022
19.2 - 28.8 VDC	50 W max.	5.0 A	0.8 A	25 W	--	60 mm	CJ1W-PD025
85 - 264 VAC 47 - 63 Hz	50 VA max.	2.8 A	0.4 A	14 W	--	45 mm	CJ1W-PA202
	100 VA max	5.0 A	0.8 A	25 W	Run output (SPST relay)	80 mm	CJ1W-PA205R
					Maintenance status display	80 mm	CJ1W-PA205C

Note: The CJ1W-PD022 has no galvanic isolation.

### I/O Expansion

Type	Description	Width, length	Model
I/O control unit	Required unit on CPU 'rack' to connect I/O expansions	20 mm	CJ1W-IC101
I/O interface unit	Start unit for each I/O expansion 'rack'. Requires a power supply unit.	31 mm	CJ1W-II101
I/O expansion cable	Connects CJ1W-IC101 or -II101 to the next expansion rack's -II101	0.3 m	CS1W-CN313
		0.7 m	CS1W-CN713
		2.0 m	CS1W-CN223
		3.0 m	CS1W-CN323
		5.0 m	CS1W-CN523
		10 m	CS1W-CN133
		12 m	CS1W-CN133-B2

## Up to 64 I/O Points per Unit – Input, Output or Mixed

Digital I/O units serve as the PLC's interface to achieve fast, reliable sequence control. A full range of units, from high-speed DC inputs to relay outputs, let you adapt CJ-Series controllers to your needs.

CJ1W units are available with various I/O densities and connection technologies. Up to 16 I/O points can be wired to units with detachable M3 screw terminals or screwless clamp terminals. High-density 32- and 64-point I/O units are equipped with standard 40-pin flat cable-connectors. Prefabricated cables and wiring terminals are available for easy interfacing to high-density I/O units.



## Ordering Information

Points	Type	Rated voltage	Rated current	Width	Remarks	Connection type <sup>1</sup>	Model
16	AC input	120 VAC	7 mA	31 mm	--	M3	CJ1W-IA111
8	AC input	240 VAC	10 mA	31 mm	--	M3	CJ1W-IA201
8	DC input	24 VDC	10 mA	31 mm	--	M3	CJ1W-ID201
16	DC input	24 VDC	7 mA	31 mm	--	M3	CJ1W-ID211
16	DC input	24 VDC	7 mA	31 mm	Fast-response (15 $\mu$ s ON, 90 $\mu$ s OFF)	M3	CJ1W-ID212
16	DC input	24 VDC	7 mA	31 mm	Inputs start interrupt tasks in PLC program	M3	CJ1W-INT01
16	DC input	24 VDC	7 mA	31 mm	Latches pulses down to 50 $\mu$ s pulse width	M3	CJ1W-IDP01
32	DC input	24 VDC	4.1 mA	20 mm	--	1 x Fujitsu	CJ1W-ID231
32	DC input	24 VDC	4.1 mA	20 mm	--	1 x MIL <sup>1</sup> (40 pt)	CJ1W-ID232
32	DC input	24 VDC	4.1 mA	20 mm	Fast-response (15 $\mu$ s ON, 90 $\mu$ s OFF)	1 x MIL <sup>1</sup> (40 pt)	CJ1W-ID233
64	DC input	24 VDC	4.1 mA	31 mm	--	2 x Fujitsu	CJ1W-ID261
64	DC input	24 VDC	4.1 mA	31 mm	--	2 x MIL <sup>1</sup> (40 pt)	CJ1W-ID262
8	Triac output	250 VAC	0.6 mA	31 mm	--	M3	CJ1W-OA201
8	Relay output	250 VAC	2 A	31 mm	Independent response	M3	CJ1W-OC201
16	Relay output	250 VAC	2 A	31 mm	--	M3	CJ1W-OC211
8	DC output (sink)	12 to 24 VDC	2 A	31 mm	--	M3	CJ1W-OD201
8	DC output (source)	24 VDC	2 A	31 mm	With short-circuit protection, alarm	M3	CJ1W-OD202

Points	Type	Rated voltage	Rated current	Width	Remarks	Connection type <sup>*1</sup>	Model
16	DC output (sink)	12 to 24 VDC	0.5 A	31 mm	--	M3	CJ1W-OD211
16	DC output (source)	24 VDC	0.5 A	31 mm	With short-circuit protection, alarm	M3	CJ1W-OD212
16	DC output (sink)	24 VDC	0.5 A	31 mm	Fast-response (15 μs ON, 80 μs OFF)	M3	CJ1W-OD213
32	DC output (sink)	12 to 24 VDC	0.5 A	20 mm	--	1x Fujitsu	CJ1W-OD231
32	DC output (source)	24 VDC	0.3 A	20 mm	With short-circuit protection, alarm	1 x MIL <sup>*1</sup> (40 pt)	CJ1W-OD232
32	DC output (sink)	24 VDC	0.5 A	20 mm	Fast-response (15 μs ON, 90 μs OFF)	1 x MIL <sup>*1</sup> (40 pt)	CJ1W-OD234
64	DC output (sink)	12 to 24 VDC	0.3 A	31 mm	--	2 x Fujitsu	CJ1W-OD261
64	DC output (source)	24 VDC	0.3 A	31 mm	--	2 x MIL <sup>*1</sup> (40 pt)	CJ1W-OD262
16 + 16	DC in+out (source)	24 VDC	0.5 A	31 mm	--	2 x MIL <sup>*1</sup> (20 pt)	CJ1W-MD232
32 + 32	DC in+out (sink)	24 VDC	0.3 A	31 mm	--	2 x MIL <sup>*1</sup> (40 pt)	CJ1W-MD263
32 + 32	DC in+out (TLL)	5 VDC	35 mA	31 mm	--	2 x MIL <sup>*1</sup> (40 pt)	CJ1W-MD563

\*1 MIL = connector according to MIL-C-83503 (compatible with DIN 41651/IEC 60603-1).

Note: All digital I/O unit are designated as basic I/O units.

A

## From Basic to Advanced Analog I/O

The CJ-series offers a wide choice of analog input units, fit for any application, to support high-speed, high-accuracy data acquisition. Analog outputs can be used for accurate control or external indication.

Advanced units with built-in scaling, filtering and alarm functions reduce the need for complex PLC programming. High-accuracy process I/O units support an extensive range of sensors, for fast and accurate data acquisition.



Temperature control units relieve the PLC CPU of PID calculations and alarm monitoring. These functions are handled autonomously by the unit, offering control performance and auto-tuning functions similar to stand-alone temperature controllers.

## Ordering Information

Points	Type	Ranges	Resolution	Accuracy (Note 2)	Conversion time	Remarks	Model		
4	Universal analog input	DC voltage, DC current, Thermocouple Pt100/Pt1000, potentiometer	1/256,000	0.05%	60 ms/4 points	All inputs individually isolated, configurable alarms, maintenance functions, user-defined scaling, zero/span adjustment	CJ1W-PH41U		
4		<table border="1"> <tr> <td>0 to 1 to 0 to 0 to 4 to</td> <td>5 V 5 V 10 V 20 mA 20 mA</td> </tr> </table>	0 to 1 to 0 to 0 to 4 to	5 V 5 V 10 V 20 mA 20 mA	V/I: 1/12,000 T/C: 0.1 °C RTD: 0.1 °C	V: 0.3% I: 0.3% T/C: 0.3% RTD: 0.3%	250 ms/4 points	Universal inputs, with zero/span adjustment, configurable alarms, scaling, sensor error detection	CJ1W-AD04U
0 to 1 to 0 to 0 to 4 to		5 V 5 V 10 V 20 mA 20 mA							
	T/C: K, J, T, L, R, S, B, Pt100, Pt1000, JPt100								
4 8	Analog input	<table border="1"> <tr> <td>0 to 1 to 0 to -10 to 4 to</td> <td>5 V 5 V 10 V 10 V 20 mA</td> </tr> </table>	0 to 1 to 0 to -10 to 4 to	5 V 5 V 10 V 10 V 20 mA	1/8,000	V: 0.2% I: 0.4%	250 µs/point	Offset/gain adjustment, peak hold, moving average, alarms	CJ1W-AD041-V1
0 to 1 to 0 to -10 to 4 to			5 V 5 V 10 V 10 V 20 mA						
	CJ1W-AD081-V1								
2 4	Analog output	<table border="1"> <tr> <td>0 to 1 to 0 to -10 to 4 to</td> <td>5 V 5 V 10 V 10 V 20 mA</td> </tr> </table>	0 to 1 to 0 to -10 to 4 to	5 V 5 V 10 V 10 V 20 mA	1/4,000	V: 0.02% I: 0.05%	1 ms/point	Offset/gain adjustment, output hold	CJ1W-DA021
0 to 1 to 0 to -10 to 4 to			5 V 5 V 10 V 10 V 20 mA						
	CJ1W-DA041								
4 + 2	Analog input + output	<table border="1"> <tr> <td>0 to 1 to 0 to -10 to 4 to</td> <td>5 V 5 V 10 V 10 V 20 mA</td> </tr> </table>	0 to 1 to 0 to -10 to 4 to	5 V 5 V 10 V 10 V 20 mA	1/8,000	In: 0.2% Out: 0.3%	1 ms/point	Offset/gain adjustment, scaling, peak hold, moving average, alarms, output hold	CJ1W-MAD42
0 to 1 to 0 to -10 to 4 to	5 V 5 V 10 V 10 V 20 mA								
4	High-speed input		1/40,000	V: 0.2% I: 0.4%	35 µs/4 points	Direct conversion (CJ2 special instruction)	CJ1W-AD042		

Points	Type	Ranges		Resolution	Accuracy (Note 2)	Conversion time	Remarks	Model
4	High-speed output	1 to 0 to -10 to	5 V 10 V 10 V	1/40,000	0.3%	35 $\mu$ s/ 4 points	Direct conversion (CJ2 special instruction)	CJ1W-DA042V
8	Voltage output	0 to 0 to -10 to 1 to	5 V 10 V 10 V 5 V	1/8,000	0.3%	250 $\mu$ s/ point	Offset/gain adjustment, output hold	CJ1W-DA08V
8	Current output	4 to	20 mA		0.5%			CJ1W-DA08C
2	Process input	4 to 0 to 0 to -10 to 0 to -5 to 1 to 0 to 1.25 to	20 mA 20 mA 10 V 10 V 5 V 5 V 5 V 1.25 V 1.25 V	1/64,000	0.05%	5/ms point	Configurable alarms, maintenance functions, user-defined scaling, zero/span adjustment, square root, totalizer	CJ1W-PDC15

**Notes:**

All Analog I/O units are designated as Special I/O units, except CJ1W-TS561/-TS562, which are Basic I/O units (cannot be used with CP1H).

Accuracy for Voltage and Current Inputs/Outputs as percentage of full scale and typical value at 25°C ambient temperature.  
Accuracy for Temperature Inputs/Outputs as percentage of process value and typical value at 25°C ambient temperature.  
(Consult the operation manual for details.)

## In-panel Temperature Control and Monitoring

Temperature control units relieve the PLC CPU of PID calculations and alarm monitoring. These functions are handled autonomously by the unit, offering control performance and auto-tuning functions similar to stand-alone temperature controllers.



## Ordering Information

Inputs	Input type	Ranges	Resolution	Accuracy (Note 2)	Conversion time	Remarks	Model	
<b>Temperature Input Units</b>								
2	Thermocouple input	B, E, J, K, L, N, R, S, T, U, WRe5-26, PLII, -100 to 100 mV	1/64,000	0.05%	5 ms/point	Configurable alarms, (absolute + rate-of-change), peak hold, maintenance functions	CJ1W-PTS15	
4		B, J, K, L, R, S, T	0.1°C	0.03% 0.05%	62.5 ms/point		4 configurable alarm outputs	CJ1W-PTS51
6					40 ms/point			CJ1W-TS561
2	Resistance thermometer input	Pt50, Pt100, JPt100, Ni508.4	1/64,000	0.05%	5 ms/point	Configurable alarms (absolute + rate-of-change), peak hold, maintenance functions	CJ1W-PTS16	
4		Pt100, JPt100	0.1°C	0.03% 0.05%	62.5 ms/point		4 configurable alarm outputs	CJ1W-PTS52
6					40 ms/point			CJ1W-TS562

### Notes:

All Analog I/O units are designated as Special I/O units, except CJ1W-TS561/-TS562, which are Basic I/O units. (cannot be used with CP1H).

Accuracy for Voltage and Current Inputs/Outputs as percentage of full scale and typical value at 25°C ambient temperature.  
Accuracy for Temperature Inputs/Outputs as percentage of process value and typical value at 25°C ambient temperature.  
(Consult the operation manual for details)

## Temperature Control Units

Specifications			Model
No. of loops	Temperature sensor inputs	Control outputs	
4 loops	Thermocouple input (R, S, K, J, T, B, L)	Open collector NPN outputs (pulses)	CJ1W-TC001
4 loops		Open collector PNP outputs (pulses)	CJ1W-TC002
2 lops, heater burnout detection function		Open collector NPN outputs (pulses)	CJ1W-TC003
2 lops, heater burnout detection function		Open collector PNP outputs (pulses)	CJ1W-TC004
4 loops	Platinum resistance thermometer input (JPt100, Pt100)	Open collector NPN outputs (pulses)	CJ1W-TC101
4 loops		Open collector PNP outputs (pulses)	CJ1W-TC102
2 lops, heater burnout detection function		Open collector NPN outputs (pulses)	CJ1W-TC103
2 lops, heater burnout detection function		Open collector PNP outputs (pulses)	CJ1W-TC104

## Open to Any Communication

The CJ-Series offers both standardized open network interfaces, and cost-efficient high-speed proprietary network links. Datalinks between PLCs, or to higher-level information systems can be made using serial or Ethernet links, or the easy-to-use controller link network.



## Ordering Information

Type	Ports	Data transfer	Protocols	Unit class	Width	Connection type	Model
Serial	2 x RS-232C		CompoWay/F, Host link, NT link, Modbus, User-defined	CPU bus unit	31 mm	9-pin D-Sub	CJ1W-SCU21-V1
Serial	2 x RS-232C	High-speed	CompoWay/F, Host link, NT link, Modbus, User-defined	CPU bus unit	31 mm	9-pin D-Sub	CJ1W-SCU22
Serial	2 x RS-422A/RS-485		CompoWay/F, Host link, NT link, Modbus, User-defined	CPU bus unit	31 mm	9-pin D-Sub	CJ1W-SCU31-V1
Serial	2 x RS-422A/RS-485	High-speed	CompoWay/F, Host link, NT link, Modbus, User-defined	CPU bus unit	31 mm	9-pin D-Sub	CJ1W-SCU32
Serial	1 x RS-232C + 1 x RS-422/RS-485		CompoWay/F, Host link, NT link, Modbus, User-defined	CPU bus unit	31 mm	9-pin D-Sub	CJ1W-SCU41-V1
Serial	1 x RS-232C + 1 x RS-422/RS-485	High-speed	CompoWay/F, Host link, NT link, Modbus, User-defined	CPU bus unit	31 mm	9-pin D-Sub	CJ1W-SCU42
Ethernet	1 x 100 Base-Tx		UDP, TCP/IP, FTP server, SMTP (e-mail), SNMP (time adjust), FINS routing, socket service	CPU bus unit	31 mm	RJ45	CJ1W-ETN21
EtherNet/IP	1 x 100 Base-Tx		EtherNet/IP, UDP, TCP/IP, FTP server, SNMP, SNMP	CPU bus unit	31 mm	RJ45	CJ1W-EIP21
DeviceNet	1 x CAN		DeviceNet	CPU bus unit	31 mm	5-p detachable	CJ1W-DRM21
PROFIBUS-DP	1 x RS-485 (Master)		DP, DPV1	CPU bus unit	31 mm	9-pin D-Sub	CJ1W-PRM21
PROFIBUS-DP	1 x RS-485 (Slave)		DP	Special I/O unit	31 mm	9-pin D-Sub	CJ1W-PRT21
PROFINET-IO	1 x 100 Base-Tx		PROFINET-IO Controller, FINS/UDP	CPU bus unit	31 mm	RJ45	CJ1W-PNT21
CAN	1 x CAN		User-defined, supports 11-bit and 29-bit identifiers	CPU bus unit	31 mm	5-p detachable	CJ1W-CORT21
CompoNet	4-wire, data + power to slaves (Master)		CompoNet (CIP-based)	Special I/O unit	31 mm	4-p detachable IDC or screw	CJ1W-CRM21
CompoBus/S	2-wire (Master)		Omron proprietary	Special I/O unit	20 mm	2-wire screw + 2-wire power	CJ1W-SRM21

# CS1-Series CPU Units

Quick Link  
H222

## Fast and Powerful CPUs for Any Task

Omron's CS1-series CPUs are available in two processor speeds, each in various memory capacities. Besides the basic CPU models, versions are available for dual redundant operation, supporting I/O hot-swapping.



## Ordering Information

Max. Digital I/O points	Program capacity	Data memory capacity	Logic execution speed	Max. I/O units	Additional functions	Model	
5120	250K steps	448K words	20 ns	80	–	CS1H-CPU67H	
				71	Supports duplex power supply and I/O hot-swapping	CS1D-CPU67S	
				68	CPU for full dual-redundancy	CS1D-CPU67H	
	CPU for full dual-redundancy, with loop control board	CS1D-CPU67P					
	80	–		CS1H-CPU66H			
	80	–		CS1H-CPU65H			
	71	120K steps	256K words	40 ns	71	Supports duplex power supply and I/O hot-swapping	CS1D-CPU65S
					68	CPU for full dual-redundancy	CS1D-CPU65H
						CPU for full dual-redundancy, with loop control board	CS1D-CPU65P
	80	–	CS1H-CPU64H				
	–	–	CS1H-CPU63H				
	–	–	CS1G-CPU45H				
1280	30K steps	64K words	40 ns	40	–	CS1G-CPU44H	
				35	Supports duplex power supply and I/O hot-swapping	CS1D-CPU44S	
960	20K steps	128K words		30	–	CS1G-CPU43H	
					–	CS1G-CPU42H	
26	Supports duplex power supply and I/O hot-swapping	CS1D-CPU42S					
960	10K steps	128K words		26	Supports duplex power supply and I/O hot-swapping	CS1D-CPU42S	

## Accessories

Description	Remarks	Model
Duplex unit, required for CS1D-CPU6_H systems	–	CS1D-DPL01
Serial communication option board, 2 x RS-232C	–	CS1W-SCB21-V1
Serial communication option board, 1 x RS-232C + 1 x RS422/RS-485	–	CS1W-SCB41-V1
Loop control option board	50 control blocks max.	CS1W-LCB01
Loop control option board	300 control blocks max.	CS1W-LCB05
Replacement battery set, for all CS1 CPUs	–	CS1W-BAT01
Compact Flash memory card, 128 MB, for all models (not required for operation)	Industrial grade flash	HMC-EF183
Compact Flash memory card, 256 MB, for all models (not required for operation)	Industrial grade flash	HMC-EF283
Compact Flash memory card, 512 MB, for all models (not required for operation)	Industrial grade flash	HMC-EF583
Compact Flash PC-Card adapter	–	HMC-AP001



### Expand with Up to 7 Racks

CS1 systems can operate on 24 VDC power supply, or on 100-240 VAC. For small-scale systems with mainly digital I/O a low cost, small capacity power supply can be used. For systems with many analog I/Os and control/communication units, it may be necessary to use a larger power supply unit.



A

## Ordering Information

### Power Supplies

Input range	Power consumption	Output capacity 5VDC	Output capacity 26 VDC	Max. output power	Extra functions	Model
19.2 to 28.8 VDC	40 W max.	6.6 A	0.62 A	30 W	-	C200HW-PD024
		4.3 A	0.56 A	28 W	Power supply for dual-redundant system	CS1D-PD024
	55 VA max.	5.3 A	1.3 A	40 W	-	C200HW-PD025
					Power supply for dual-redundant system	CS1D-PD025
85 to 264 VAC 50/60 Hz	120 VA max.	4.6 A	0.62 A	30 W	Maintenance status display	C200HW-PA204C
-					C200HW-PA204	
Service output 24 VDC, 0.8 A					C200HW-PA204S	
Run status output (SPST relay)					C200HW-PA204R	
Run status output (SPST relay)					C200HW-PA209R	
85 to 132 VAC, 170 to 264 VAC, 50/60 Hz	180 VA max.	9.0 A	1.3 A	45 W	Run status output (SPST relay)	C200HW-PA209R
	150 VA max.	7.0 A	1.3 A	35 W	Power supply for dual-redundant system	CS1D-PA207R

### Backplanes

Type	Slots	Expansion connector	Width	Special functions	Model
CPU	2	No	200 mm	-	CS1W-BC023
CPU	3	Yes	260 mm	-	CS1W-BC033
CPU	5	Yes	330 mm	-	CS1W-BC053
CPU	8	Yes	435 mm	-	CS1W-BC083
CPU	10	Yes	505 mm	-	CS1W-BC103
Expansion	3	Yes	260 mm	-	CS1W-BI033
Expansion	5	Yes	330 mm	-	CS1W-BI053
Expansion	8	Yes	435 mm	-	CS1W-BI083
Expansion	10	Yes	505 mm	-	CS1W-BI103
CPU	5	Yes	505 mm	For Duplex CPU + Power supplies	CS1D-BC052
CPU	8	Yes	505 mm	For Duplex Power supplies	CS1D-BC082S
Expansion	9	Yes	505 mm	For Duplex Power supplies	CS1D-BI092

For I/O Expansion Cables visit [www.omron247.com](http://www.omron247.com).

## Up to 96 I/O Points per Unit – Input, Output or Mixed

Digital I/O units serve as the PLC's interface to achieve fast, reliable sequence control. A full range of units, from high-speed DC inputs to relay outputs, let you adapt CS1 to your needs.

CS1 units are available with various I/O densities and connection technologies. Up to 16 I/O points can be wired to units with detachable M3 screw terminals directly. High-density 32- and 64- point I/O units are equipped with standard 40-pin connectors. Prefabricated



cables and wiring terminals are available for easy interfacing to high-density I/O units.

## Ordering Information

Points	Type	Rated voltage	Rated current	Remarks	Connection type	Model <sup>*1</sup>
16	AC input	120 VAC	10 mA	--	M3	CS1W-IA111
16	AC input	240 VAC	10 mA	--	M3	CS1W-IA211
16	DC input	24 VDC	7mA	--	M3	CS1W-ID211
16	DC input	24 VDC	7mA	Inputs start interrupt tasks in PLC program	M3	CS1W-INT01
16	DC input	24 VDC	7mA	Latches pulses down to 50 µs pulse width	M3	CS1W-IDP01
32	DC input	24 VDC	6mA	--	1 x 40 pt Fujitsu	CS1W-ID231
64	DC input	24 VDC	6mA	--	2 x 40 pt Fujitsu	CS1W-ID261
96	DC input	24 VDC	5mA	--	2 x 56 pt Fujitsu	CS1W-ID291
8	Triac output	250 VAC	1.2 A	--	M3	CS1W-OA201
16	Triac output	250 VAC	0.5 A	--	M3	CS1W-OA211
8	Relay output	250 VAC	2.0 A	--	M3	CS1W-OC201
16	Relay output	250 VAC	2.0 A	--	M3	CS1W-OC211
16	DC output (sink)	12 to 24 VDC	0.5 A	--	M3	CS1W-OD211
16	DC output (source)	24 VDC	0.5 A	With short-circuit protection, alarm	M3	CS1W-OD212
32	DC output (sink)	12 to 24 VDC	0.5 A	--	1 x 40 pt Fujitsu	CS1W-OD231
32	DC output (source)	24 VDC	0.5 A	With short-circuit protection, alarm	1 x 40 pt Fujitsu	CS1W-OD232
64	DC output (sink)	12 to 24 VDC	0.3 A	--	2 x 40 pt Fujitsu	CS1W-OD261
64	DC output (source)	24 VDC	0.3 A	With short-circuit protection, alarm	2 x 40 pt Fujitsu	CS1W-OD262
96	DC output (sink)	12 to 24 VDC	0.1 A	--	2 x 56 pt Fujitsu	CS1W-OD291
96	DC output (source)	24 VDC	0.1 A	--	2 x 56 pt Fujitsu	CS1W-OD292
32+32	DC output (sink)	12 to 24 VDC	0.3 A	--	2 x 40 pt Fujitsu	CS1W-MD261
32+32	DC in+out (source)	24 VDC	0.3 A	With short-circuit protection, alarm	2 x 40 pt Fujitsu	CS1W-MD262
48+48	DC output (sink)	12 to 24 VDC	0.1 A	--	2 x 56 pt Fujitsu	CS1W-MD291
48+48	DC in+out (source)	12 to 24 VDC	0.1 A	--	2 x 56 pt Fujitsu	CS1W-MD292

\*1 C200H I/O units can also be mounted, except on CS1D systems. Note: All Digital I/O units are designated as Basic I/O units.

### From Basic Analog I/O to Process Control

CS1 offers a wide range of analog input units fit for any application, from low-speed, multi-channel temperature measurement to high-speed, high-accuracy data acquisition. Analogue outputs can be used for accurate control or external indication.

Advanced units with built-in scaling, filtering and alarm functions reduce the need for complex PLC programming. High-accuracy process I/O units support an extensive range of sensors, for fast and accurate data acquisition. All process and temperature I/O units provide isolation between all individual channels.



### Ordering Information

Points	Type	Ranges	Resolution	Accuracy <sup>1</sup>	Conversion time	Remarks	Model
4	Analog input	0 to 5 V, 0 to 10 V, -10 to 10 V, 1 to 5 V, 4 to 20 mA	1/8,000	V: 0.2% I: 0.4%	250 µs/point	Offset/gain adjustment, peak hold, moving average, alarms	CS1W-AD041-V1
8				CS1W-AD081-V1			
16				CS1W-AD161			
4	Analog output	0 to 5 V, 0 to 10 V, -10 to 10 V, 1 to 5 V, 4 to 20 mA	1/4,000	V: 0.3% I: 0.5%	1 ms/point	Offset/gain adjustment	CS1W-DA041
4 + 4	Analog in + output	0 to 5 V, 0 to 10 V, -10 to 10 V, 1 to 5 V (4 to 20 mA input)	1/8,000	V in: 0.2% I in: 0.4% out: 0.3%		Offset/gain adjustment, scaling, peak hold, moving average, alarms, output hold	CS1W-MAD44
8	Voltage output	0 to 5 V, 0 to 10 V, -10 to 10 V, 1 to 5 V	1/4,000	0.3%	1 ms/point	Offset/gain adjustment, output hold	CS1W-DA08V
8	Current output	4 to 20 mA		0.5%			CS1W-DA08C
4	Process input	4 to 20 mA, 0 to 20 mA, 0 to 10 V, -10 to 10 V, 0 to 5 V, -5 to 5 V, 1 to 5 V, 1 to 1.25 V, -1.25 to 1.25 V	1/64,000	0.05%	5 ms/point	Configurable alarms, maintenance functions, user-defined scaling, zero/span adjustment, square root, totalizer	CS1W-PDC11

# CS1-Series

## Analog and Process I/O Units (continued)

Quick Link

H222

Points	Type	Ranges	Resolution	Accuracy <sup>1</sup>	Conversion time	Remarks	Model		
8	Process input	-10 to 10 V, 0 to 5 V, 1 to 5 V, 4 to 20 mA	1/16,000	0.3% of PV	62.5 ms/ point	Configurable alarms, zero/span adjustment, square root	CS1W-PDC55		
4	2-Wire transmitter input	1 to 5 V, 4 to 20 mA	1/4,096	0.2%	25 ms/point	Built-in power supply for transmitter, configurable alarms, square root, rate-of-change, etc.	CS1W-PTW01		
8	Power transducer input	-1 to 1 mA, 0 to 1 mA -100 to 100 mV, 0 to 100 mV	1/4,096	0.2%	25 ms/point	Inrush current limiter, configurable alarms, averaging, etc.	CS1W-PTR01		
			1/4,096	0.2%	25 ms/point		CS1W-PTR02		
4	Pulse rate input	20000 pps, voltage, open collector, contact	up to 1/32,000	--	25 ms/point	Averaging, totalizer	CS1W-PPS01		
<b>Temperature Input Units</b>									
4	Thermocouple input	B, E, J, K, L, N, R, S, T, U, WRe5-26, PLII, -100 to 100 mV	1/64,000	0.05%	5 ms/ point	Configurable alarms, (absolute + rate-of-change), peak hold, maintenance functions	CS1W-PTS11		
4			B, J, K, L, R, S, T	0.1°C	0.3%		62.5 ms/ point	4 configurable alarm outputs	CS1W-PTS51
8							31.2 ms/ point		CS1W-PTS55
4	Resistance thermometer input	Pt50, Pt100, JPt100, Ni508.4	1/64,000	0.05%	5 ms/ point	Configurable alarms (absolute + rate-of-change), peak hold, maintenance functions	CJ1W-PTS12		
4			Pt100, JPt100	0.1°C	0.3%		62.5 ms/ point	4 configurable alarm outputs	CS1W-PTS52
8							31.2 ms/ point		CS1W-PTS56
<b>Isolated Control Output Units</b>									
4	Isolated control output	1 to 4 to	5 V 20 mA	1/4,000	I: 0.1% V: 0.2%	25 ms/ point	Output readback, high/low/rate limiting, disconnection alarm, zero/span adjustment	CS1W-PMV01	
4		-10 to 0 to -5 to 0 to -1 to 0 to	10 V 10 V 5 V 5 V 1 V 1 V	1/4,000	0.1%			10 ms/ point	High/low/rate limiting, output hold, zero/span adjustment

**Notes:**

Accuracy for Voltage and Current Inputs/Outputs as percentage of full scale and typical value at 25°C ambient temperature.  
Accuracy for Temperature Inputs/Outputs as percentage of process value and typical value at 25°C ambient temperature.  
(Consult the operation manual for details)

All Analog I/O units are designated as Special I/O units, except CJ1W-TS561/-TS562, which are Basic I/O units.

## Open to Any Communication, Standard or User-Defined

CS1 provides both standardized open network interfaces, and cost-efficient, high-speed proprietary network links. Datalinks between PLCs, or to higher-level information systems can be made using Serial or Ethernet links, or the easy-to-use Controller Link network.



Omron supports the two major field networks – DeviceNet and PROFIBUS-DP. For high-speed field I/O, CompoNet offers unsurpassed ease of installation and a lower material costs than other networks. Fully user-configurable

serial and CAN-based communication can be used to emulate a variety of application-specific protocols.

## Ordering Information

Type	Ports	Protocols	Unit class	Connection type	Model
Serial	2 x RS-232C	CompoWay/F, Host Link, NT link, Modbus, User-defined	CPU bus unit	9-pin D-Sub	CS1W-SCU21-V1
Serial	2 x RS-232C/RS-485	CompoWay/F, Host Link, NT link, Modbus, User-defined	CPU bus unit	9-pin D-Sub	CS1W-SCU31-V1
Serial	2 x RS-232C	CompoWay/F, Host Link, NT link, Modbus, User-defined	CPU option board	9-pin D-Sub	CS1W-SCB21-V1
Serial	1 x RS-232C + 1 x RS-422/RS-485	CompoWay/F, Host Link, NT link, Modbus, User-defined	CPU option board	9-pin D-Sub	CS1W-SCB41-V1
GP-IB	Master/Slave selectable	GP-IB instrument communication	Special I/O unit	GP-IB	CS1W-GPI01
Ethernet	1 x 100 Base-Tx	UDP, TCP/IP, FTP server, SMTP (e-mail), SNTP (time adjust), FINS routing, socket service	CPU bus unit	RJ45	CS1W-ETN21
Controller link	2-wire twisted pair	Omron proprietary	CPU bus unit	2-wire screw+GND	CS1W-CLK21-V1
	Optical HPCF			2 x HPCF connector	CS1W-CLK12-V1
	Optical graded-index fiber			4 x ST connector	CS1W-CLK52-V1
EtherNet/IP	1 x 100 Base-Tx	EtherNet/IP, UDP, TCP/IP, FTP server, SNTP, SNMP	CPU Bus unit	RJ45	CS1W-EIP21
DeviceNet	1 x CAN	DeviceNet	CPU bus unit	5-p detachable	CS1W-DRM21-V1
CompoNet	4-wire, data + power to slaves (Master)	CompoNet (CIP-based)	Special I/O unit	4-p detachable IDC or screw	CS1W-CRM21
PROFIBUS-DP	1 x RS-485 (Master)	DP, DPV1	CPU bus unit	9-pin D-Sub	CS1W-PRM21
CAN	1 x CAN	CANopen, User-defined	CPU bus unit	5-p detachable	CS1W-CORT21
PROFIBUS-DP	1 x RS-485 (Slave)	DP	C200H special I/O unit; cannot be used on CS1D systems	9-pin D-Sub	C200HW-PRT21
CompoBus/S	2-wire (Master)	Omron proprietary		2-wire screw + 2-wire power	C200HW-SRM21-V1

## The All-In-One PLC

Designed for compact machines, it combines the compactness of a micro PLC and the power of a modular PLC. Four built-in high-speed counters and four pulse outputs are ideal for multi-axis positioning control. The CP1H-XA comes with four analog inputs and two analog outputs built-in. This makes it suitable for simple loop control, using the PLC's advanced PID control function with auto-tuning. The CP1H can be expanded with CP-series I/Os and supports up to two CJ1 special I/O units. This means that it is open to popular fieldbuses and supports all communication units of the CJ1 series.



- Up to 1 MHz for inputs/outputs
- CJ1M compatible instruction set
- 4 analog inputs and 2 analog outputs for the XA model
- USB port for easy communication, programming and configuration
- Supports PROFIBUS, DeviceNet, CAN, Ethernet/IP and Ethernet

## Ordering Information

Built-in functions: E = Encoder inputs; I/C = Interrupts/counters; P = Pulse outputs

Input points	Output points	Expandable up to*	Program capacity	Data memory capacity	Power supply	Output method	Built-in functions			Model	
							E	I/C	P		
<b>CP1H-X with pulse outputs for 4 axes</b>											
24	16	320 points	20K steps	32K words	85 to 264 VAC	Relay output	4	8	--	CP1H-X40DR-A	
						20.4 to 26.4 VDC	Transistor output (sink type)	4	8	4	CP1H-X40DT-D
						Transistor output (source type)	4	8	4	CP1H-X40DT1-D	
<b>CP1H-XA with built-in analog I/O (4 analog inputs/2 analog outputs; 1/12,000 resolution)</b>											
24	16	320 points	20K steps	32K words	85 to 264 VAC	Relay output	4	8	--	CP1H-XA40DR-A	
						20.4 to 26.4 VDC	Transistor output (sink type)	4	8	4	CP1H-XA40DT-D
						Transistor output (source type)	4	8	4	CP1H-XA40DT1-D	
<b>CP1H-Y with 1-MHz pulse I/O</b>											
12	8	300 points	20K steps	32K words	20.4 to 26.4 VDC	Transistor output (sink type)	4**	6	4**	CP1H-YS0DT-D	

\*CP1H CPU series can be expanded with CP-series Expansion Units and CJ1 Special I/O Units.

\*\* Encoder inputs: 2x 1 MHz + 2x 100 kHz; Pulse outputs: 2x 1 MHz + 2x 100 kHz.

## The Compact Machine Controller

Omron's CP1L series offers the compactness of a micro-PLC with the capability of a modular PLC. It provides all the functionality you need to control your machine, including outstanding positioning capability. The CP1L comes with 14, 20, 30, 40, or 60 I/O built-in and can be expanded with a wide range of CP-series expansion units up to 180 I/O points. It uses a standard USB port for programming and monitoring and offers two optional plug-in serial communication ports—additionally, one port can be used for a display or Ethernet option. The CP1L series shares the same architecture as the CP1E, CP1H, CJ, and



CS1 series, programs are compatible for memory allocations and instructions.

- Encoder inputs: 100 kHz
- Pulse outputs: 100 kHz (transistor models)
- Logic execution speed: 0.55 μs

## Ordering Information

Built-in functions: E = Encoder inputs; I/C = Interrupts/counters; P = Pulse outputs

Input points	Output points	Expands up to*	Program capacity	Data memory	Power supply	Output type	Built-in functions			Model
							E	I/C	P	
6	4	10	5K steps	10 K words	85 to 264 VAC	Relay	4	2	--	CP1L-L10DR-A
						20.4 to 26.4 VDC	Relay	4	2	--
					20.4 to 26.4 VDC	Transistor (sinking)	4	2	2	CP1L-L10DT-D
						Transistor (sourcing)	4	2	2	CP1L-L10DT1-D
8	6	54	5K steps	10 K words	85 to 264 VAC	Relay	4	4	--	CP1L-L14DR-A
						20.4 to 26.4 VDC	Relay	4	4	--
					20.4 to 26.4 VDC	Transistor (sinking)	4	4	2	CP1L-L14DT-D
						Transistor (sourcing)	4	4	2	CP1L-L14DT1-D
12	8	60	5K steps	10 K words	85 to 264 VAC	Relay	4	6	--	CP1L-L20DR-A
						20.4 to 26.4 VDC	Relay	4	6	--
					20.4 to 26.4 VDC	Transistor (sinking)	4	6	2	CP1L-L20DT-D
						Transistor (sourcing)	4	6	2	CP1L-L20DT1-D
18	12	150	10 K steps	32 K words	85 to 264 VAC	Relay	4	6	--	CP1L-M30DR-A
						20.4 to 26.4 VDC	Relay	4	6	--
					20.4 to 26.4 VDC	Transistor (sinking)	4	6	2	CP1L-M30DT-D
						Transistor (sourcing)	4	6	2	CP1L-M30DT1-D
24	16	160	10 K steps	32 K words	85 to 264 VAC	Relay	4	6	--	CP1L-M40DR-A
						20.4 to 26.4 VDC	Relay	4	6	--
					20.4 to 26.4 VDC	Transistor (sinking)	4	6	2	CP1L-M40DT-D
						Transistor (sourcing)	4	6	2	CP1L-M40DT1-D
36	24	180	10 K steps	32 K words	85 to 264 VAC	Relay	4	6	--	CP1L-M60DR-A
						20.4 to 26.4 VDC	Relay	4	6	--
					20.4 to 26.4 VDC	Transistor (sink)	4	6	2	CP1L-M60DT-D
						Transistor (source)	4	6	2	CP1L-M60DT1-D

\*CP1L CPU series can be expanded with CP-series Expansion Units.

## Easy, Efficient and Economic

The CP1E comes with 10, 14, 20, 30, 40 or 60 I/O built-in and can be expanded with a wide range of CP-series expansion units up to 160 I/O points. The “-N” type offers pulse outputs, a built-in serial port, and capacity for plug-in serial and Ethernet ports. As the CP1E series shares the same architecture as the CP1L, CP1H, CJ, and CS1 series, programs are compatible for memory allocations and instructions.



## Ordering Information

Specifications									Model
Power supply	Inputs	Outputs	Output type	Pulse outputs	Serial port	Analog I/O	Program capacity	Data memory capacity	
100 to 240 VAC	6	4	Relay	No	No	No	2K steps	2K words	CP1E-E10DR-A
			Transistor (sinking)						CP1E-E10DT-A
			Transistor (sourcing)						CP1E-E10DT1-A
24 VDC	6	4	Relay	No	No	No	2K steps	2K words	CP1E-E10DR-D
			Transistor (sinking)						CP1E-E10DT-D
			Transistor (sourcing)						CP1E-E10DT1-D
100 to 240 VAC	8	6	Relay	No	No	No	2K steps	2K words	CP1E-E14DR-A
	12	8	Relay	No	No	No	2K steps	2K words	CP1E-E20DR-A
	18	12	Relay	No	No	No	2K steps	2K words	CP1E-E30DR-A
	24	16	Relay	No	No	No	2K steps	2K words	CP1E-E40DR-A
100 to 240 VAC	8	6	Relay	No	Built-in	No	8K steps	8K words	CP1E-N14DR-A
			Transistor (sinking)	Yes					CP1E-N14DT-A
			Transistor (sourcing)	Yes					CP1E-N14DT1-A
24 VDC	8	6	Relay	No	Built-in	No	8K steps	8K words	CP1E-N14DR-D
			Transistor (sinking)	Yes					CP1E-N14DT-D
			Transistor (sourcing)	Yes					CP1E-N14DT1-D
100 to 240 VAC	12	8	Relay	No	Built-in	No	8K steps	8K words	CP1E-N20DR-A
			Transistor (sinking)	Yes					CP1E-N20DT-A
			Transistor (sourcing)	Yes					CP1E-N20DT1-A
24 VDC	12	8	Relay	No	Built-in	No	8K steps	8K words	CP1E-N20DR-D
			Transistor (sinking)	Yes					CP1E-N20DT-D
			Transistor (sourcing)	Yes					CP1E-N20DT1-D



## Ordering Information (Continued)

Specifications									Model
Power supply	Inputs	Outputs	Output type	Pulse outputs	Serial port	Analog I/O	Program capacity	Data memory capacity	
100 to 240 VAC	18	12	Relay	No	Built-in	No	8K steps	8K words	CP1E-N30DR-A
			Transistor (sinking)	Yes					CP1E-N30DT-A
			Transistor (sourcing)	Yes					CP1E-N30DT1-A
24 VDC	18	12	Relay	No	Built-in	No	8K steps	8K words	CP1E-N30DR-D
			Transistor (sinking)	Yes					CP1E-N30DT-D
			Transistor (sourcing)	Yes					CP1E-N30DT1-D
100 to 240 VAC	24	16	Relay	No	Built-in	No	8K steps	8K words	CP1E-N40DR-A
			Transistor (sinking)	Yes					CP1E-N40DT-A
			Transistor (sourcing)	Yes					CP1E-N40DT1-A
24 VDC	24	16	Relay	No	Built-in	No	8K steps	8K words	CP1E-N40DR-D
			Transistor (sinking)	Yes					CP1E-N40DT-D
			Transistor (sourcing)	Yes					CP1E-N40DT1-D
100 to 240 VAC	36	24	Relay	No	Built-in	No	8K steps	8K words	CP1E-N60DR-A
			Transistor (sinking)	Yes					CP1E-N60DT-A
			Transistor (sourcing)	Yes					CP1E-N60DT1-A
24 VDC	36	24	Relay	No	Built-in	No	8K steps	8K words	CP1E-N60DR-D
			Transistor (sinking)	Yes					CP1E-N60DT-D
			Transistor (sourcing)	Yes					CP1E-N60DT1-D
100 to 240 VAC	12	8	Relay	No	Built-in	2 in-puts, 1 output	8K steps	8K words	CP1E-NA20DR-A
24 VDC			Transistor (sinking)	Yes					CP1E-NA20DT-D
Transistor (sourcing)			Yes	CP1E-NA20DT1-D					

### Expand the Capacity of Your Micro PLC

A wide variety of expansion units such as Digital I/O, Analogue I/O and Remote I/O are available to create the application you need. These CP expansion units can be used for, CP1E, CP1L, and CP1H series PLC.



- Expansion Unit Types: Digital Inputs (up to 8 Inputs)
- Digital Outputs (up to 32 Outputs, NPN, PNP, Relay)
- Mixed I/O (up to 24 Inputs and 16 Outputs)
- Analog Input Unit with 4 Inputs, 1/6000 resolution
- Analog Output Unit with 4 Outputs, 1/6000 resolution
- Analog Mixed I/O Units with 2 Inputs and 1 Output, 1/256 or 1/6000 resolutions
- Temperature Sensor Units with 2 or 4 Inputs (Thermocouple or Platinum Resistance types)
- Temperature Sensor Unit with 2 Platinum Resistance Inputs and 1 Voltage/Current output
- DeviceNet I/O Link Unit (I/O Link of 32 Input bits and 32 Output bits)
- ProfiBus-DP I/O Link Unit (I/O Link of 16 Input bits and 16 Output bits)
- Ethernet Option Units available
- Serial Option Units (RS-232C and combination RS-232C / RS-422)

### Ordering Information

Description	Output type	Input points	Output points	Size in mm (HxWxD)	Model
Expansion I/O units	--	8	--	90x66x50	CP1W-8ED
	Relay	--	8	90x66x50	CP1W-8ER
	Transistor (sinking)	--	8	90x66x50	CP1W-8ET
	Transistor (sourcing)	--	8	90x66x50	CP1W-8ET1
	Relay	--	16	90x86x50	CP1W-16ER
	Relay	12	8	90x96x50	CP1W-20EDR1
	Transistor (sinking)	12	8	90x96x50	CP1W-20EDT
	Transistor (sourcing)	12	8	90x96x50	CP1W-20EDT1
	Relay	24	16	90x150x50	CP1W-40EDR
	Transistor (sinking)	24	16	90x150x50	CP1W-40EDT
	Transistor (sourcing)	24	16	90x150x50	CP1W-40EDT1
Analog I/O units	Analog (resolution 1/256)	2	1	90x66x50	CPM1A-MAD01
	Analog (resolution 1/6000)	2	1	90x86x50	CP1W-MAD11
	Analog (resolution 1/6000)	4	--	90x86x50	CP1W-AD041
	Analog (resolution 1/6000)	--	4	90x86x50	CP1W-DA041

# CP-Series Expansion Units

## Micro PLC (continued)



A

Description	Output type	Input points	Output points	Size in mm (HxWxD)	Model
Temperature sensor input units	Thermocouple input	2	--	90x86x50	CP1W-TS001
	Thermocouple input	4	--	90x86x50	CP1W-TS002
	Platinum resistance input	2	--	90x86x50	CP1W-TS101
	Platinum resistance input	4	--	90x86x50	CP1W-TS102
	Platinum resistance input and voltage/current output	2	1	90x86x50	CPM1A-TS101-DA
I/O link units	DeviceNet	32 bits	32 bits	90x66x50	CPM1A-DRT21
	PROFIBUS-DP	6 bits	16 bits	90x66x50	CPM1A-PRT21

### Options for CPU Units

Name		Specifications	Model
RS-232C Option Board		Can be mounted in either CPU Unit Option Board slot 1 or 2. Note: Cannot be used for the CP1L-L10.	CP1W-CIF01
RS-422A/485 Option Board		Can be mounted in either CPU Unit Option Board slot 1 or 2. Note: Cannot be used for the CP1L-L10. Maximum transmission distance: 50m	CP1W-CIF11
RS-422A/485 Isolated-type Option Board		One RS-422A/485 port (Isolated) Note: Cannot be used for the CP1L-L10. Maximum transmission distance: 500m	CP1W-CIF12
LCD Option Board		Can be mounted only in the CPU Unit Option Board slot 1. Note: Cannot be used for the CP1L-L10.	CP1W-DAM01
Memory Cassette		Can be used for backing up programs or auto-booting	CP1W-ME05M
Economical Ethernet Option Board		Two can be mounted in either of CPU Unit Option Board slot 1 and 2. Note: Cannot be used for the CP1L-L10.	CP1W-ETN61
Advanced Ethernet Option Board		One can be mounted in either CPU Unit Option Board slot 1 or 2. Note: Cannot be used for the CP1L-L10.	CP1W-CIF41
Ethernet/IP Slave Option Board		One can be mounted in either CPU Unit Option Board slot 1 or 2. Note: Cannot be used for the CP1L-L10.	CP1W-EIP61
Modbus/TCP Slave Option Board		One can be mounted in either CPU Unit Option Board slot 1 or 2. Note: Cannot be used for the CP1L-L10.	CP1W-MODTCP61

# CPM2C CPU Units

## Micro PLC

Quick Link  
H232

### The Versatile Slim-Line Controller

An extensive range of models ensures efficient machine control in an ultra-compact package. CPU units are available with relay or transistor output, terminal block or various connector options, and an optional real-time clock function. Select the output type, number of I/O points and other specifications to meet your needs. Expansion I/O units with 8 to 32 I/O points make it possible to configure a control system with a maximum of 192 I/O points.

- Space-saving slim outline, just 90H x 33W x 65D mm, with high-density I/O
- 10-32 I/O points per CPU, transistor or relay outputs
- 20 kHz counter input, two 10 kHz pulse outputs integrated
- Two communication ports built-in, accessible with communication cable



- Digital, analog, and fieldbus expansion units
- CompoBus/S master (CPM2C-S) models function as a DeviceNet slave
- Logic execution speed of 0.64  $\mu$ s

# CPM2C Expansion Units

## Micro PLC

Quick Link  
H232

### Expand the capacity of your CPM2C PLC

Expansion I/O units with 8 to 32 I/O points make it possible to configure a control system with a maximum of 192 I/O points.

- Expansion Unit Types: Digital Inputs (up to 16 Inputs)
- Digital Outputs (up to 16 Outputs, NPN, PNP, Relay)
- Mixed I/O (up to 16 Inputs and 16 Outputs)
- Analog I/O Unit with 2 Inputs and 1 Output)
- Temperature Sensor Units (Thermocouple or Platinum Resistance types)
- CompoBus/S I/O Link Unit (I/O Link of 8 Input bits and 8 Output bits)
- Serial Adaptor Units (RS-232C and combination RS-232C / RS-422)



## Easy to Use for Small Scale Control Applications, Offers Precision and Space Savings

- Accurate analog inputs  $\pm 1.5\%$  FS
- Wide supply voltage range of 10.8 to 28.8 VDC
- Flexible mounting — either horizontal or vertical
- New CPUs with built-in RS-485 communications for data sharing
- Advanced high-value counting with 8-digit counter and 8-digit comparators, in addition to 16 standard counters
- One 150-Hz high-speed counter available on models with DC power supply
- Twin-timer operation allows you to set ON and OFF times separately, greatly simplifying intermittent operation
- Password function ensures security
- Display user-set messages or analog-converted values



## ZEN Support Software

- Easily write ladder programs, monitor programs online, set parameters, print, and save files in the Windows® environment
- Offers simulation capability to simplify program debugging; allows programs to be simulated on a personal computer without connecting to ZEN

## System Advantages

- Easily write ladder programs, monitor programs online, set parameters, print, and save files in the Windows® environment
- Delivers the flexibility and functionality of separate timers, counters, and relays for control applications with up to 44 I/O
- New economy CPU models — perfect for applications that require less than 10 or 20 points of I/O. (Does not accept expansion units)
- Save time by using the memory cassette to transfer programs between ZEN units and standardize updates to end users
- Reduce wiring and engineering time using simple ladder logic programming with the push of a button or click of the mouse
- Easily add up to 3 ultra-slim 35 mm, 8 I/O expansion units when more points of control are required

## Ordering Information

### 10-Point CPU Programmable Relay Units

Description	Inputs/power supply		Outputs		Analog input/comparators	8-digit counter/comparators	Model
10 I/O CPU Expandable up to 34 I/O	6	100 to 240 VAC	4	Relays	—	Yes / 4	ZEN-10C1AR-A-V2
		12 to 24 VDC		Transistors	2 Ch. 0 - 10V / 4		ZEN-10C1DR-D-V2
	100 to 240 VAC	Relays	—	ZEN-10C1DT-D-V2			
10 I/O CPU Economy model (non-expandable)	6	12 to 24 VDC	4	Relays	—	—	ZEN-10C3AR-A-V2
		100 to 240 VAC			2 Ch. 0 - 10V / 4		ZEN-10C3DR-D-V2
9 I/O CPU with RS-485 Communications Expandable up to 33 I/O	6	100 to 240 VAC	3	Relays	—	—	ZEN-10C4AR-A-V2
		12 to 24 VDC			2 Ch. 0 - 10V / 4		ZEN-10C4DR-D-V2

## 20-Point CPU Programmable Relay Units

Description	Inputs/power supply	Outputs	Analog input/comparators	8-digit counter/comparators	Model
20 I/O CPU Expandable up to 44 I/O	12 100 to 240 VAC 12 to 24 VDC	8 Relays	—	Yes / 4	ZEN-20C1AR-A-V2
			2 Ch. 0 - 10V / 4		ZEN-20C1DR-D-V2
20 I/O CPU Economy model (non-expandable)	100 to 240 VAC 12 to 24 VDC	Relays	—	Yes / 4	ZEN-20C1DT-D-V2
			2 Ch. 0 - 10V / 4		ZEN-20C3AR-A-V2
					ZEN-20C3DR-D-V2

## I/O Expansion Units

Description	Inputs/power supply	Outputs	Model
8 I/O Expansion units	4 100 to 240 VAC 12 to 24 VDC	4 Relays	ZEN-8E1AR
			ZEN-8E1DR
		Transistors	ZEN-8E1DT

## ZEN Accessories

Description	Model
ZEN Support Software	ZEN-SOFT01V4
ZEN Programming cable - Serial to ZEN (2 m)	ZEN-CIF01
Memory cassette - Copies program to multiple units	ZEN-ME01
ZEN Battery - Use with controller CPU to provide 10 years of memory protection to prevent data loss in the event of an extended power outage (45 H x 17.5 W x 44 D mm)	ZEN-BAT01

## ZEN Starter Kit

The kit provides a great introduction to the power and simplicity of the ZEN Series. It includes everything for self-training, system design, and installation:

- 10 I/O CPU
- PC programming cable (RS-232 to ZEN)
- Support software
- Manuals
- Simulator switches

Description	Model
AC I/O Kit with ZEN-10C1AR-A-V2	ZEN-STARTER01-V2
DC I/O Kit with ZEN-10C1DR-D-V2	ZEN-STARTER02-V2

<b>Contents</b>		
<b>Selection Guide</b>		B-ii
<b>Operator Interface Terminals</b>		
<b>NS</b>	High-performance, bright, clear, and scalable, with advanced troubleshooting	B-1
<b>NSJ</b>	NS with integrated controller for DeviceNet nodes	B-2
<b>NB</b>	OEM-focused color touch screens, with exceptional graphics and essential features	B-4
<b>NV</b>	Compact, low-cost, monochrome and color touch screen	B-5
<b>Function Key Message Displays</b>		
<b>NT11</b>	Large alphanumeric 4-line Display with function keys	B-6
<b>NT2S</b>	Compact, powerful 2-line message display with function keys	B-7
<b>PC-based Operator Interface Solutions</b>		
<b>NSA</b>	Industrial Panel PC with RAS functions	B-8
<b>NSR</b>	Complete NS terminal functions on a PC	B-9



## OMRON VISUALIZATION – CREATE AND OPERATE

Powerful visualization solutions from the most basic to advanced applications. Omron has the right visualization solution based on decades of global, field-proven experience.



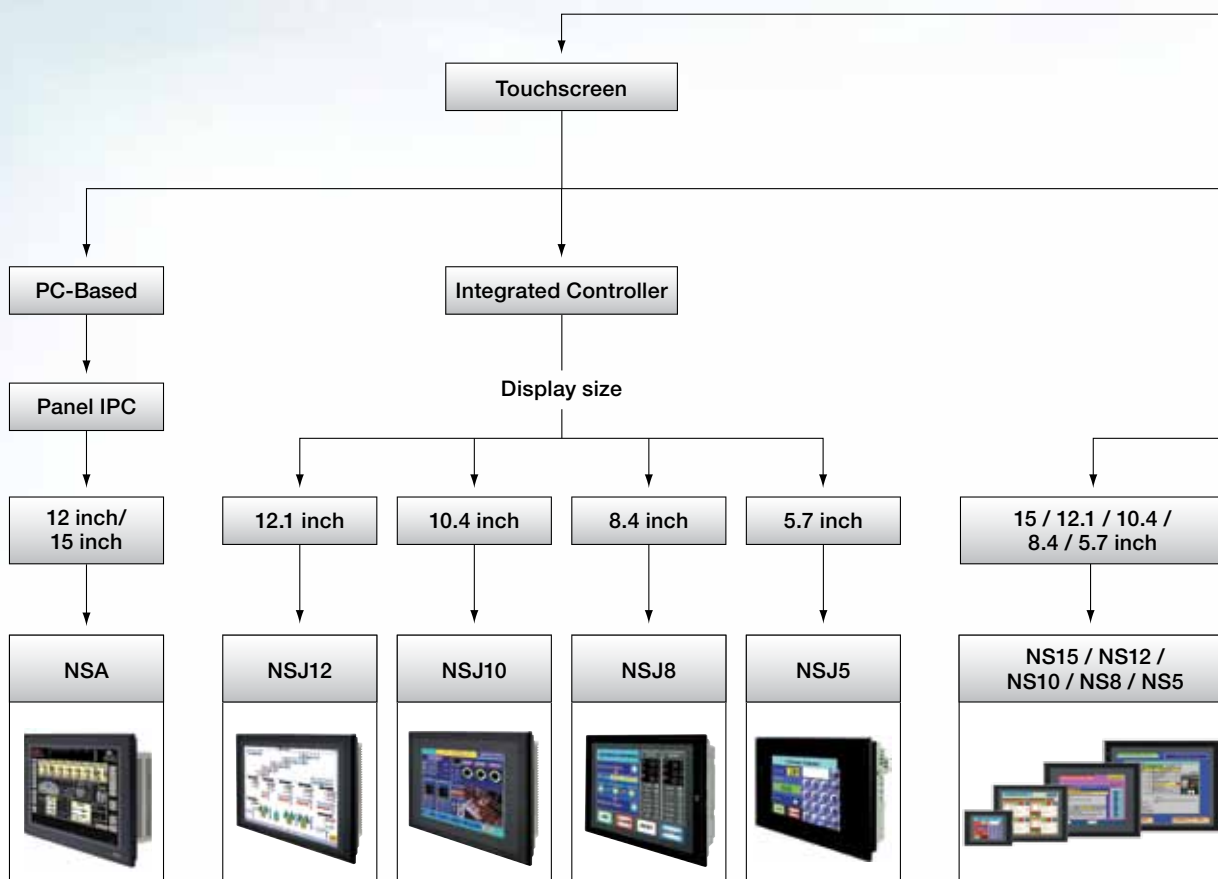

- Best touchscreen synergy with Omron automation products such as: Controllers, Temperature Controllers, Motion Systems, Vision and Industrial Networks
- Extremely reliable platforms, rugged, with industry-leading approvals and specifications
- Time-saving software and simulation tools, reduce costs and commissioning time
- Unparalleled built-in troubleshooting features, designed to reduce downtime
- Screen design software is included in Automation Software Suites: Sysmac Studio, CX-One, and CX-One Lite

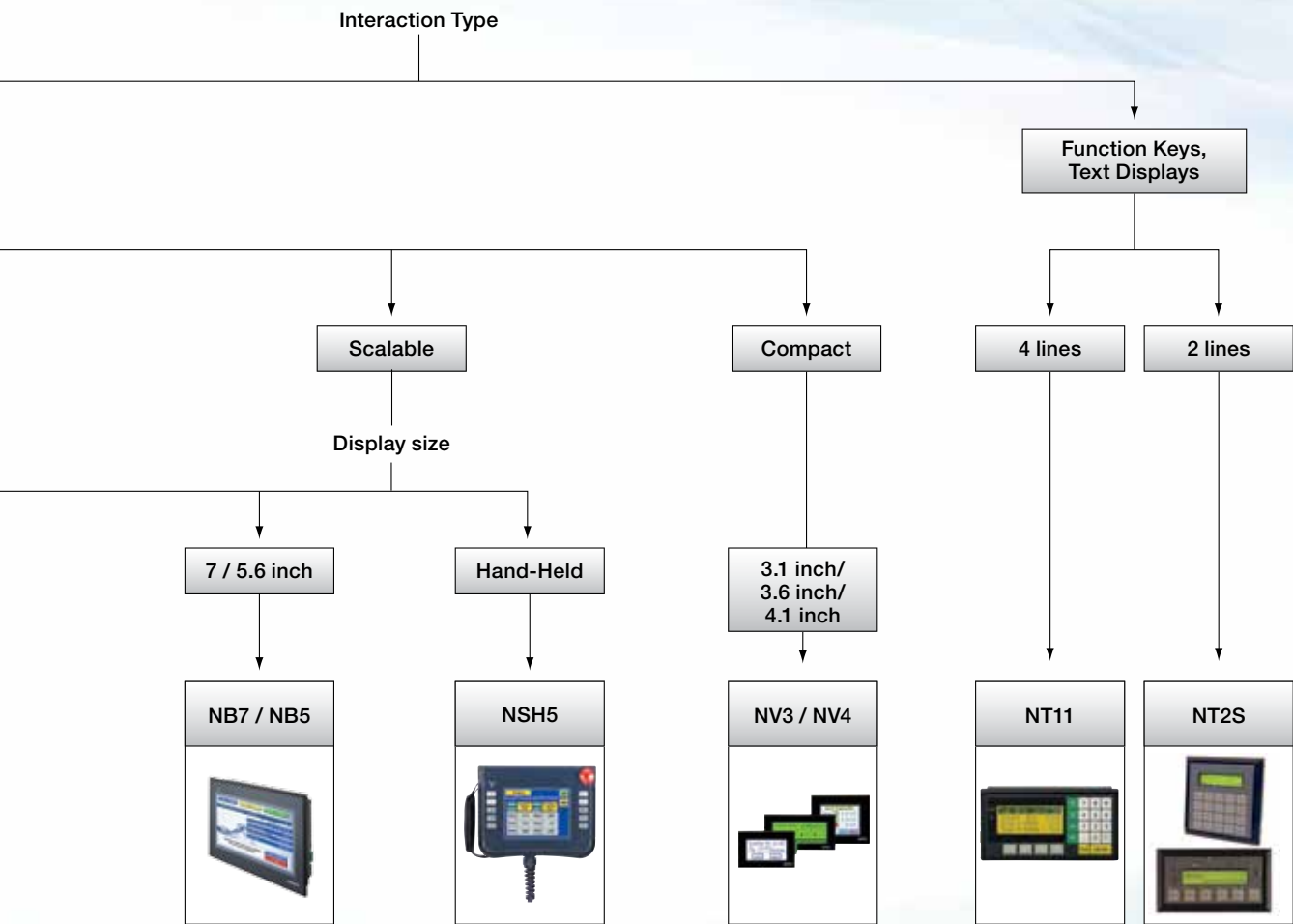











## Selection Table

Scalable Operator Interface Terminals					
					
Model	<b>NS15</b>	<b>NS12</b>	<b>NS10</b>	<b>NS8</b>	<b>NS5</b>
Display	15 inch TFT color	12.1 inch TFT color	10.4 inch TFT color	8.4 inch TFT color	STN Monochrome or TFT color
Resolution	1024 x 768 pixels (XGA)	800 x 600 pixels (SVGA)	640 x 480 pixels (VGA)	640 x 480 pixels (VGA)	320 x 240 pixels (QVGA)
Number of colors	256 (32,768 for image data)	256 (32,768 for image data)	256 (32,768 for image data)	256 (32,768 for image data)	Monochrome 16 grayscales, STN/TFT 256 colors (STN 4096, TFT 32,768 for image data)
Memory Size	• 60MB screen memory				
Ethernet Available	Yes				
Options	<ul style="list-style-type: none"> <li>• Controller Link</li> <li>• Video input board (NS-CA002)</li> <li>• Black or Silver bezel</li> </ul>	<ul style="list-style-type: none"> <li>• Controller Link</li> <li>• Video input board (RGB/Composite)</li> <li>• Black or ivory bezel</li> </ul>	<ul style="list-style-type: none"> <li>• Controller Link</li> <li>• Video input board (RGB/Composite)</li> <li>• Black or ivory bezel</li> </ul>	<ul style="list-style-type: none"> <li>• Video input board (RGB/Composite)</li> <li>• Black or ivory bezel</li> </ul>	<ul style="list-style-type: none"> <li>• Black or ivory bezel</li> </ul>
Features	Omron EtherNet/IP tags, USB, FTP interface, Smart Active Parts (SAP), Single Port Multi Access (SPMA), Programming Console, Built-in Troubleshooter				
Dimensions (HxWxD mm)	300 x 400 x 80	241 x 315 x 48.5	241 x 315 x 48.5	177 x 195 x 48.5	142 x 195 x 54



# Operator Interface Terminals

B



Scalable Operator Interface Terminals			
			
Model	NSH5	NB7	NB5
Display	5.7 inch STN color handheld	7 inch TFT Color	5.6 inch TFT Color
Resolution	320 x 240 pixels (QVGA)	800x480 pixels (WVGA)	320x234 pixels (QVGA)
Number of colors	256 colors (4096 colors for image data)	65,536	65,536
Memory Size	• 60MB screen memory	• 128MB	• 128MB
Ethernet Available	No	Coming Soon	
Features	Smart Active Parts (SAP), Single Port Multi Access (SPMA), Programming Console, Built-in Troubleshooter	50,000hr LED Backlight, Vector and Animated Graphics, Extensive Library, Pop-Up and Transparent Windows, Dual Serial Comm, Data Logging, Trending, Alarms, Granular Security, FREE software	
Dimensions (HxWxD mm)	176 x 223 x 70.5 (excl. emergency button)	148 x 202 x 46	142 x 184 x 46

Operator Interface with Integrated Controller				
				
Model	NSJ12	NSJ10	NSJ8	NSJ5
Type of Display	12.1 inch color TFT	10.4 inch color TFT	8.4 inch color TFT	5.7 inch color TFT or STN
Display Size / Resolution	246x184.5 mm (800x600 pixels)	215.5x162.4 mm (640x480 pixels)	170.9x128.2 mm (640x480 pixels)	117.2x88.4 mm (320x240 pixels)
Control	<ul style="list-style-type: none"> <li>• CJ1G-CPU45H</li> <li>• 60k-steps program memory</li> <li>• 128k-words data memory</li> <li>• logic instruction time 0.04 µs</li> </ul>	<ul style="list-style-type: none"> <li>• CJ1G-CPU45H</li> <li>• 60k-steps program memory</li> <li>• 128k-words data memory</li> <li>• logic instruction time 0.04 µs</li> </ul>	<ul style="list-style-type: none"> <li>• CJ1G-CPU45H</li> <li>• 60k-steps program memory</li> <li>• 128k-words data memory</li> <li>• logic instruction time 0.04 µs</li> <li>• CJ1M-CPU13</li> <li>• 20k-steps program memory</li> <li>• 32k-words data memory</li> <li>• logic instruction time 0.04 µs</li> </ul>	<ul style="list-style-type: none"> <li>• CJ1G-CPU45H</li> <li>• 60k-steps program memory</li> <li>• 128k-words data memory</li> <li>• logic instruction time 0.04 µs</li> <li>• CJ1M-CPU13</li> <li>• 20k-steps program memory</li> <li>• 32k-words data memory</li> <li>• logic instruction time 0.04 µs</li> </ul>
Communication	DeviceNet Master/Slave or PROFIBUS Master and optional Ethernet interface			
Expansion (1 board max.)	<ul style="list-style-type: none"> <li>• Controller Link</li> <li>• I/O extension</li> </ul>			
Dimensions (HxWxD mm)	<ul style="list-style-type: none"> <li>• Without expansion unit 241 x 315 x 73.3</li> <li>• With expansion unit 241 x 315 x 89.3</li> </ul>	<ul style="list-style-type: none"> <li>• Without expansion unit 241 x 315 x 73.3</li> <li>• With expansion unit 241 x 315 x 89.3</li> </ul>	<ul style="list-style-type: none"> <li>• Without expansion unit 177 x 232 x 73.3</li> <li>• With expansion unit 177 x 232 x 89.3</li> </ul>	<ul style="list-style-type: none"> <li>• Without expansion unit 195 x 142 x 79</li> <li>• With expansion unit 195 x 142 x 95</li> </ul>

# Selection Table

	Industrial Panel PC	Compact Touchscreens
		
Model	NSA	NV3/NV4
Features	<ul style="list-style-type: none"> <li>• No moving parts to fail – no hard disk drive or fan</li> <li>• Industrial PC with touch panel</li> <li>• High-speed 1.3 GHz Intel Celeron M processor</li> <li>• RAS board and utility software continuously monitor motherboard status enabling post error retry, CMOS data recovery and more</li> </ul>	<ul style="list-style-type: none"> <li>• Compact and horizontal models with 3.1-inch to 4.6-inch and QVGA displays</li> <li>• True Type Fonts for flexible screen designs</li> <li>• Space-saving installation</li> <li>• Multi-language support</li> <li>• Compatible with PLCs and controls from multiple global vendors</li> </ul>
Display	<ul style="list-style-type: none"> <li>• 12.1-inch, 15-inch, TFT LCD display</li> </ul>	<ul style="list-style-type: none"> <li>• NV3W: 3.1-inch STN monochrome LCD</li> <li>• NV4W: 4.6-inch STN monochrome LCD</li> <li>• NV3Q-M: 3.6-inch STN monochrome LCD</li> <li>• NV3Q-S: 3.6-inch STN color LCD</li> </ul>
Resolution	1024 x 768 pixels	<ul style="list-style-type: none"> <li>• NV3W: 128 x 64 pixels</li> <li>• NV4W: 320 x 120 pixels</li> <li>• NV3Q: 320 x 240 pixels</li> </ul>
Interface	<ul style="list-style-type: none"> <li>• RS-232C x 2 ports</li> <li>• EtherNet port for RJ45</li> <li>• USB 2.0 Type A x 2 ports</li> <li>• Compact Flash card slot</li> </ul>	<ul style="list-style-type: none"> <li>• Host Link, Modbus-RTU</li> <li>• RS-232C or RS-422A/RS-485</li> <li>• NV4W/NV3Q: USB tool port</li> <li>• NV3W: serial tool port</li> </ul>
Number of colors	<ul style="list-style-type: none"> <li>• 262,144 displayed</li> <li>• Cold cathode fluorescent lamps (CCFL) backlights</li> </ul>	<ul style="list-style-type: none"> <li>• NV_W: 3 color backlight LEDs</li> <li>• NV3Q-M: 3 color backlight LEDs</li> <li>• NV3Q-S: 1 color backlight LED</li> </ul>
Memory Size	512 MB RAM, 4 GB storage	384 KB
Max. number of screens	No limit	<ul style="list-style-type: none"> <li>• NV3Q-MR: 240 screens</li> <li>• NV3Q-SW: 180 screens</li> <li>• NV4W: 250 screens</li> <li>• NV3W: 160 screens</li> </ul>
Options	<ul style="list-style-type: none"> <li>• PLC PCI board equivalent to CS1G-CPU45H</li> <li>• Controller Link support boards for PCI bus</li> <li>• NS-Runtime software emulates Omron NS-series capabilities for a PC</li> <li>• Black or silver bezel</li> </ul>	–
Dimensions (HxWxD mm)	<ul style="list-style-type: none"> <li>• NSA 12: 264 x 322 x 100</li> <li>• NSA 15: 312 x 384 x 108</li> </ul>	<ul style="list-style-type: none"> <li>• NV3W: 72 x 110 x 28</li> <li>• NV4W: 74 x 146 x 30</li> <li>• NV3Q: 92.2 x 110 x 33.8</li> </ul>

# Operator Interface Terminals

Function Key/Text Displays		
Model	NT11	NT2S
		
Features	<ul style="list-style-type: none"> <li>• Password protected screens</li> <li>• 4 function keys, number pad</li> <li>• Bar graph capability</li> <li>• Large characters</li> <li>• Long backlight life (50,000 hrs.)</li> </ul>	<ul style="list-style-type: none"> <li>• PLC message display</li> <li>• Programmable function keys</li> <li>• Password protected screens</li> <li>• 5 VDC power from PLC port</li> </ul>
Display	4 line x 20 character, backlit monochrome STN LCD	2 line x 16 character, LED backlit LCD
Resolution	160 x 64 pixels	–
Interface	<ul style="list-style-type: none"> <li>• Host Link</li> <li>• NT Link (1:1)</li> </ul>	<ul style="list-style-type: none"> <li>• Host Link</li> <li>• Multi-vendor PLC</li> </ul>
Number of colors	–	–
Memory Size	32 KB	24 KB
Max. number of screens	250	750
Options	–	–
Dimensions (HxWxD mm)	113 x 218 x 38.2	6-key: 60 x 109 x 28 8-key: 106.9 x 106.9 x 35.9

**B**

## Complete Machine Management with Advanced Troubleshooting Capabilities

The NS advanced operator interfaces have brilliant display screens that maximize machine visualization. Features include Omron EtherNet/IP tag support, easy USB communication, FTP interface on Ethernet models, Smart Active Parts (SAP) for easier design, Single Port Multi Access (SPMA) for one-point maintenance, Ladder Monitor, Programming Console, and Built-in Troubleshooters for Omron controllers. The screen design software, CX-Designer, is included in each of Omron's Automation Software Suites - Sysmac Studio, CX-One, and CX-One Lite.

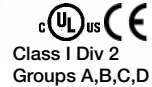

- Supports the NJ-Series Machine Automation Controller (MAC) with Ethernet/IP
- Bright & Clear Displays: LED backlight on most models
- Scalable Projects: One software for all screens 5.7"-15", with automatic conversion
- Remote Maintenance & Operation: FTP Interface with Ethernet models
- Centralized Error Reporting: Built-in Troubleshooters for complete Omron solutions

## Ordering Information

Description	Size	Resolution	Memory size	Features	Model
Advanced operator interface terminals	15-inch TFT	1,024 x 768	60 MB onboard	Ethernet	NS15-TX01B-V2
	12.1-inch TFT	800 x 600		—	NS12-TS00B-V2
				Ethernet	NS12-TS01B-V2
	10.4-inch TFT	640 x 480		—	NS10-TV00B-V2
				Ethernet	NS8-TV01B-V2
	8.4-inch TFT			—	NS8-TV00B-V2
			Ethernet	NS8-TV01B-V2	
	5.7-inch TFT High-Luminance	320 x 240	60 MB onboard	—	NS5-TQ00B-V2
				Ethernet	NS5-TQ01B-V2
	5.7-inch TFT Handheld	—		NSH5-SQR00B-V2	
	5.7-inch TFT	—		NS5-SQ00B-V2	
		Ethernet		NS5-SQ01B-V2	
	5.7-inch STN monochrome	—		NS5-MQ00B-V2	
		Ethernet		NS5-MQ01B-V2	

## Integrates Control, Display, and an Open I/O Network

Omron's NSJ-Series delivers the industry's most cost-effective and flexible combination of control, display and I/O capabilities in a single, space-saving package. True deterministic control, all NSJ terminals have separate but integrated processors for display and control tasks, so control response is never compromised due to heavy graphics demands.





 Class I Div 2  
 Groups A,B,C,D

- **Hardware Cost Savings:** Reduced number of components from a minimum seven to one, smaller control panel, less wires and conduit
- **Installation Time Savings:** One device installation, built-in self-diagnostic screens, monitor control program from display
- **Reduced Design Time:** No backplate layout required, easy to incorporate into existing systems, standardization, expandable and flexible hardware
- **Lower Operational Costs:** Reduced spares, 45% less power than separate controller and terminal
- **InnerBus Technology:** Built-in, fast, enriched communications, no need to purchase, setup or install Ethernet

## Ordering Information

Display size/type	Resolution	Programming/device ports			DeviceNet Master	Printer Port	I/O	Model
		Ethernet*	USB	Serial				
5.7-inch TFT color	320 x 240	No	Yes	Yes	Yes	No	1280	NSJ5-SQ10B-G5D
							640	NSJ5-SQ10B-M3D
		Yes	Yes	Yes	Yes	No	1280	NSJ5-SQ11B-G5D
							640	NSJ5-SQ11B-M3D
5.7-inch HD TFT color	320 x 240	No	Yes	Yes	Yes	No	1280	NSJ5-TQ10B-G5D
							640	NSJ5-TQ10B-M3D
		Yes	Yes	Yes	Yes	No	1280	NSJ5-TQ11B-G5D
							640	NSJ5-TQ11B-M3D
8.4-inch HD TFT color	640 x 480	No	Yes	Yes	Yes	USB	1280	NSJ8-TV00B-G5D
							640	NSJ8-TV00B-M3D
		Yes	Yes	Yes	Yes	USB	1280	NSJ8-TV01B-G5D
							640	NSJ8-TV01B-M3D
10.4-inch HD TFT color	640 x 480	No	Yes	Yes	Yes	USB	1280	NSJ10-TV00B-G5D
		Yes	Yes	Yes	Yes	USB	1280	NSJ10-TV01B-G5D
12.1-inch HD TFT color	800 x 600	No	Yes	Yes	Yes	USB	1280	NSJ12-TS00B-G5D
		Yes	Yes	Yes	Yes	USB	1280	NSJ12-TS01B-G5D

\* Models with built-in Ethernet do not support socket or mail services. If these are required, order a plug-in NSJW-ETN21 Ethernet Unit and an NSJ without built-in Ethernet.

## Network and Expansion Options

### Standard Configuration

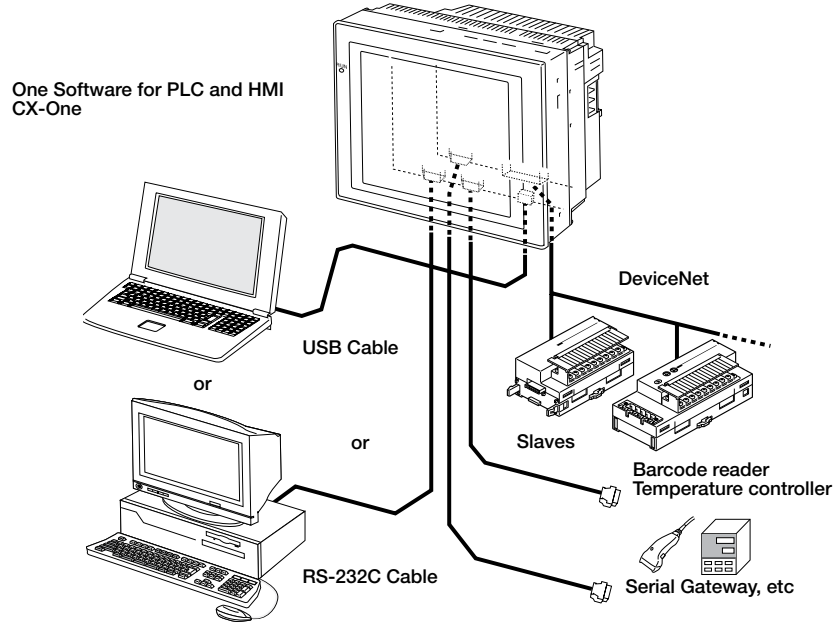

### Standard Configuration with I/O Expansion Unit

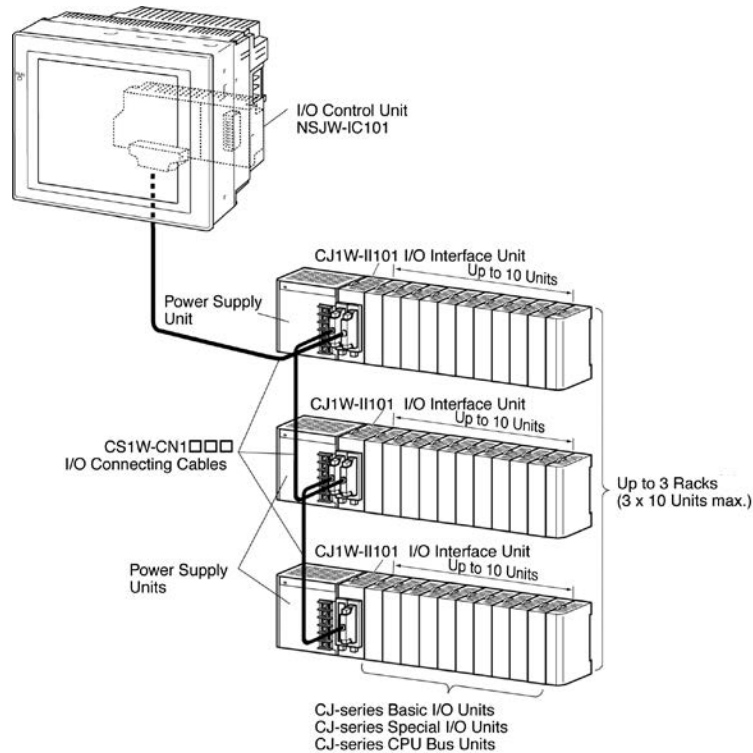



## Graphic OEM Focused High Function Touch Screen

Think lean automation in vivid color. This screen provides best-in-class color and brightness with numerous features designed for CP1 PLC applications.

- 5.6 or 7 inch models
- 65K Color TFT Display with LED Backlight
- Dual Serial & USB Comm.
- Extensive Graphic Library
- Animation Support
- Data Logging/Trending, Recipes, Alarms
- Highly Granular User Login and Password protection
- FREE Downloadable Screen Design Software
- Template Screens for CP1 PLC



B

## Ordering Information

Display size/type	Resolution	Backlight	Memory	Model
5.6-inch TFT color	320 x 234 pixels	LED	128 MB	NB5Q-TW00B
7-inch TFT color	800 x 480 pixels	LED	128 MB	NB7W-TW00B

## Compact and Simple Operator Interfaces

Highly functional and a wide range of sizes make this touchscreen series the ideal choice for lean automation.

- Extreme thin designs requiring only 1 inch of panel depth
- Choose from 3.1-, 3.6- or 4.6-inch LCD screen sizes
- Tri-color backlight or full-color displays for dynamic screen results
- Directly connect to Omron temperature controllers without need for PLC
- TrueType fonts with multi-language support for international markets
- Compatible with all Omron PLCs and global multi-vendor PLCs



- Easy-to-use NV Designer software included in CX-One Lite or CX-One software suites
- USB and SD memory card options
- Mount in landscape or portrait orientation for more design flexibility

## Ordering Information

Screen size	Resolution	Backlight	Communications	Power supply voltage	Model
3.1-in. STN monochrome	128 x 64 pixels	LEDs, 3 colors (green, orange and red)	RS-232C	5 VDC	NV3W-MG20L
			RS-232C	24 VDC	NV3W-MG20
			RS-422A/485	24 VDC	NV3W-MG40
3.1-in. STN monochrome	128 x 64 pixels	LEDs, 3 colors (white, pink and red)	RS-232C	5 VDC	NV3W-MR20L
			RS-232C	24 VDC	NV3W-MR20
			RS-422A/485	24 VDC	NV3W-MR40
4.6-in. STN monochrome	320 x 120 pixels	LEDs, 3 colors (green, orange and red)	RS-232C	24 VDC	NV4W-MG21
			RS-422A/485	24 VDC	NV4W-MG41
4.6-in. STN monochrome	320 x 120 pixels	LEDs, 3 colors (white, pink and red)	RS-232C	24 VDC	NV4W-MR21
			RS-422A/485	24 VDC	NV4W-MR41
3.6-in. STN monochrome	20 x 240 pixels (QVGA)	White LED	RS-232C	24 VDC	NV3Q-SW21
			RS-422A/485	24 VDC	NV3Q-SW41

## Large Alphanumeric 4-Line Display with Function Keys

Compact, simple and easy to use operator interface allows accurate monitoring and controlling, and includes slide-in legend for custom labeling of function keys. The extra-large keys on the numeric keypad provide operators the tactile feedback for quick data input or screen change, even when wearing thick work gloves.



  
Class I Div 2  
Groups A,B,C,D

- 4 line x 20 character backlit LCD display
- Mix 1- and 2-wide characters in one display; inverse display selectable
- 32KB memory (up to 250 screens)
- 4 global programmable function keys use menu-based screen navigation
- Keypad allows operators to input and enter numeric data
- Bar graph capability
- Password-protected screens
- Printer port built in (25-pin female connector)
- Host link/1:1 NT link communication
- Contrast control
- NEMA 4
- Black or ivory front bezel

## Ordering Information

Display data source	External settings	Power supply	Features	Model
Programmable	4 function keys	External 24 VDC	Ivory case	NT11-SF121-EV1
			Black case	NT11-SF121B-EV1

## Cables

Function	Connections	Applicable models	Cable length	Model
Connect NT11 to Programming cable	9-pin RS-232C to RS-232C for PC	—	2 m	C200H-CN229-EU CBL-202 in Canada
Connect NT11 to Omron PLC	9-pin D-sub to PLC 9-pin serial port	CPM1, CPM2, CQM1, C200H/C200HE/C200HG/C200HX, CP1, CJ2, CS1	0.5 m	C200H-CN510-EU
			3 m	C200H-CN320-EU
			5 m	C200H-CN520-EU
	9-pin D-sub to PLC mini-peripheral port adaptor	CPM2, CQM1H, CJ1, CS1	2 m	CS1W-CN118
NT Series Support Tool Software	—	—	—	NT-ZJCAT1-EV4

## Compact Powerful 2-Line Message Display with Function Keys

- High-visibility backlit LCD display shows 2 lines of 16 characters
- Programmable or PLC message display models available
- Multi-vendor PLC support models available
- 6 or 8 function keys available for screen and project level assignment
- Easy numeric entry using arrow or numeric keypad
- Two bit-assignable LED indicators on 6-key models
- Power from PLC peripheral port or external 24 VDC power supply
- Password protect any programmable function key



- Built-in bar graph display capability
- IP65 enclosure rating
- All models meet cULus, CE, and Class I, Division 2 ratings for use in hazardous areas
- Programming software available free from our website

## Ordering Information

Display data source	External settings	Features	Power supply voltage	Model
Programmable	6 function keys	Real-time clock; multi-vendor PLC support	External 24 VDC (1.5 W)	NT2S-SF121B-EV2
PLC ASCII-based program		—	5 VDC (0.75 W)	NT2S-SF122B-EV2 NT2S-SF123B-EV2
Programmable	8 function keys, number pad	Real-time clock, multi-vendor PLC support	External 24 VDC (1.5 W)	NT2S-SF125B-E
PLC ASCII-based program		—	5 VDC (0.75 W)	NT2S-SF126B-E NT2S-SF127B-E

## Guaranteed Continuity

The NSA IPC is designed to provide exceptional performance operating 24/7 throughout its lifetime. Unlike many personal computers that have very short life cycles, the NSA Industrial PC is a product with guaranteed continuity.

## No Moving Parts to Fail

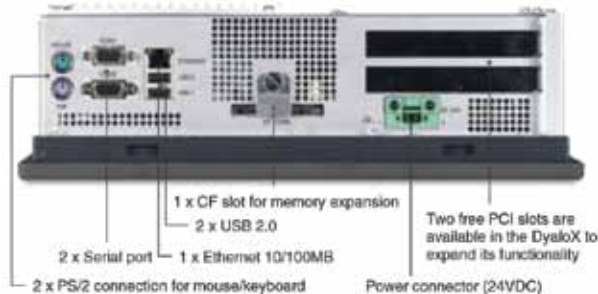

Fewer moving parts mean fewer potential causes of failure and therefore a more reliable product. So instead of a hard disk drive, the new NSA IPC series uses a silicon storage module that offers fast access and exceptional ruggedness. And instead of an electric fan to cool the CPU, heat is radiated away by a heavy heatsink with cooling fins.

## No Hard Disk Drive

“Disk on Module” is a very reliable silicon storage type with bad sector management and industrial operating temperatures.

## Ordering Information

Description	Specifications	Model
NSA Industrial PC 12"	1.3 Ghz Celeron M, 512 MB RAM, 4 GB storage, XPe, no fan, no HDD, black	NSA12-TX01B-E
	1.3 Ghz Celeron M, 512 MB RAM, 4 GB storage, XPe, no fan, no HDD, silver	NSA12-TX01S-E
NSA Industrial PC 15"	1.3 Ghz Celeron M, 512 MB RAM, 4 GB storage, XPe, no fan, no HDD, black	NSA15-TX01B-E
	1.3 Ghz Celeron M, 512 MB RAM, 4 GB storage, XPe, no fan, no HDD, silver	NSA15-TX01S-E
NSA Industrial PC Main board battery	—	NSA-BAT01
NSA Industrial PC RAS board battery	—	NSA-BAT02
CS1G-CPU45H PLC PCI board	CS1-CPU45H, DeviceNet Master and CF interface	CS1PC-PCI01H-DRM
Interface for CS1 extension backplanes	—	CS1PC-EIC01
Controller Link Support Board for PCI Bus	H-PCF cable optical ring	3G8F7-CLK12-E
	GI cable optical ring	3G8F7-CLK52-E
	Twisted-pair cable	3G8F7-CLK21-E

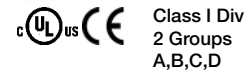

## No Fan

A fan is a very critical part of a PC. If the fan fails then the complete system eventually breaks down. That is why we chose a fan-less concept.

## RAS Board for Continuous Monitoring

Inside the NSA IPC series, a separate RAS board, interfaced by embedded RAS utility software, continually monitors the motherboard. Because the RAS board is a stand-alone board, it can gather data from the motherboard no matter what the Operating System or hardware conditions are. RAS stands for Reliability, Availability, Serviceability.

B

## Emulates NS-Series Capabilities on a PC, Running CX-Designer Projects

NS-Runtime provides the ability to operate a CX-Designer application on a PC where an open platform environment is required. This allows the PC to function as a dedicated operator interface in factory automation settings. It can also be used as a supervisory tool to view factory run rates.

- Scalable visualization, regardless of dedicated or PC-based operator interface requirements, from one CX-Designer project
- Run a new application created with CX-Designer (up to 3840 x 2400 pixels) on a Windows PC
- Communicate with Omron CJ, CP1 and CS PLCs via Ethernet, Controller Link or Serial
- Reuse existing NS-Series projects with additional functionality, like PDF document viewer and running other Windows applications
- Run an existing NS-Series project as an additional PC-based operator interface, either



- on-site or at remote locations. Ideal when combined with the NSA industrial panel PC and for OEMs for remote maintenance
- Have NS-Runtime available on-site as a PC-based backup in case the dedicated NS-Series operator interface is damaged
- Supplied with USB dongle
- Barcode reader to USB port support
- Additional macros for string manipulation, window manipulation, and launching applications
- Expansive data log capacity: 160,000 points compared to NS-Series' 50,000 points

## Ordering Information

Description	Model
NS-Runtime (1) License, CD ROM, USB Dongle, Documentation	NS-NSRCL1
NS-Runtime (3) Licenses, CD ROM, USB Dongle, Documentation	NS-NSRCL3
NS-Runtime (10) Licenses, CD ROM, USB Dongle, Documentation	NS-NSRCL10

NOTE: NS-Runtime does not yet support the NJ-Series Machine Automation Controller (MAC)

## Contents

<b>Selection Guide</b>		C-ii
<b>Remote I/Os</b>		
<b>GRT</b>	SmartSlice I/O System	C-1
<b>DRT2</b>	In-panel DeviceNet I/O	C-2
<b>DRT2</b>	On-machine DeviceNet I/O	C-4
<b>CRT1</b>	CompoNet I/O	C-5
<b>ERT1</b>	EtherNet/IP I/O	C-6
<b>GX</b>	EtherCAT Remote I/O	C-7
<b>WE70</b>	Wireless EtherNet/IP	C-9
<b>Remote Terminal Blocks &amp; Cabling</b>		
<b>XW2□</b>	Wire Terminals	C-10
<b>G7TC/G70A/ G70D</b>	Relay Terminal Blocks	C-12

C

## SmartSlice – INTELLIGENCE POINT BY POINT

SmartSlice is the most advanced, yet easy-to-use remote I/O system currently available. Its built-in intelligence will help to reduce the effort you spend on engineering, troubleshooting and maintenance in your machine, line or plant. By keeping track of control performance and logging all operations, each module can provide timely warnings, preventing costly machine downtime.

SmartSlice supports the open communication standards EtherCAT, PROFINET-IO, PROFIBUS-DP, DeviceNet, CompoNet and MECHATROLINK-II. This provides you the flexibility to adapt to local requirements, anywhere in the world, without changing your I/O.

- Reduce engineering time
- Reduce machine downtime
- Increase your efficiency





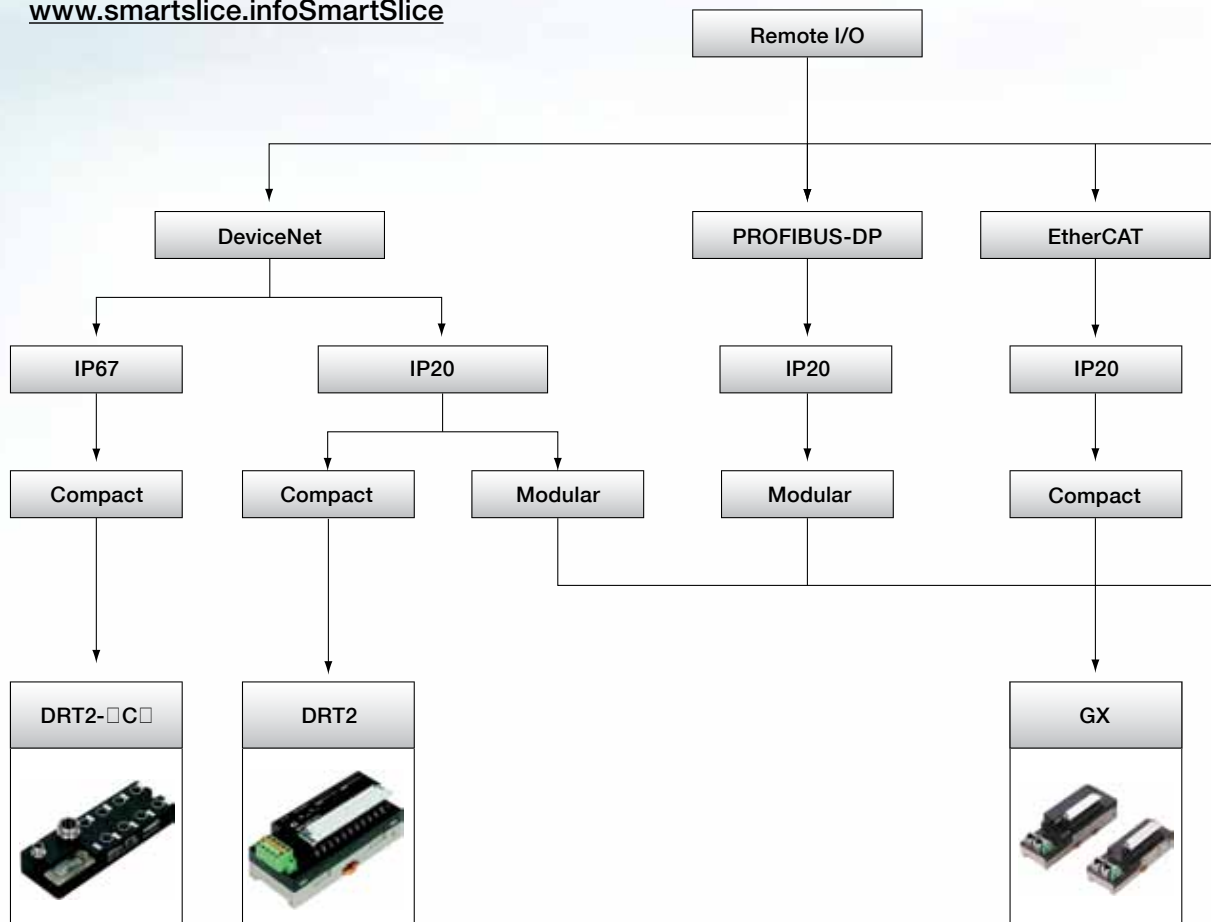

The five most used smart features are demonstrated at:  
[www.smartslice.info](http://www.smartslice.info) SmartSlice

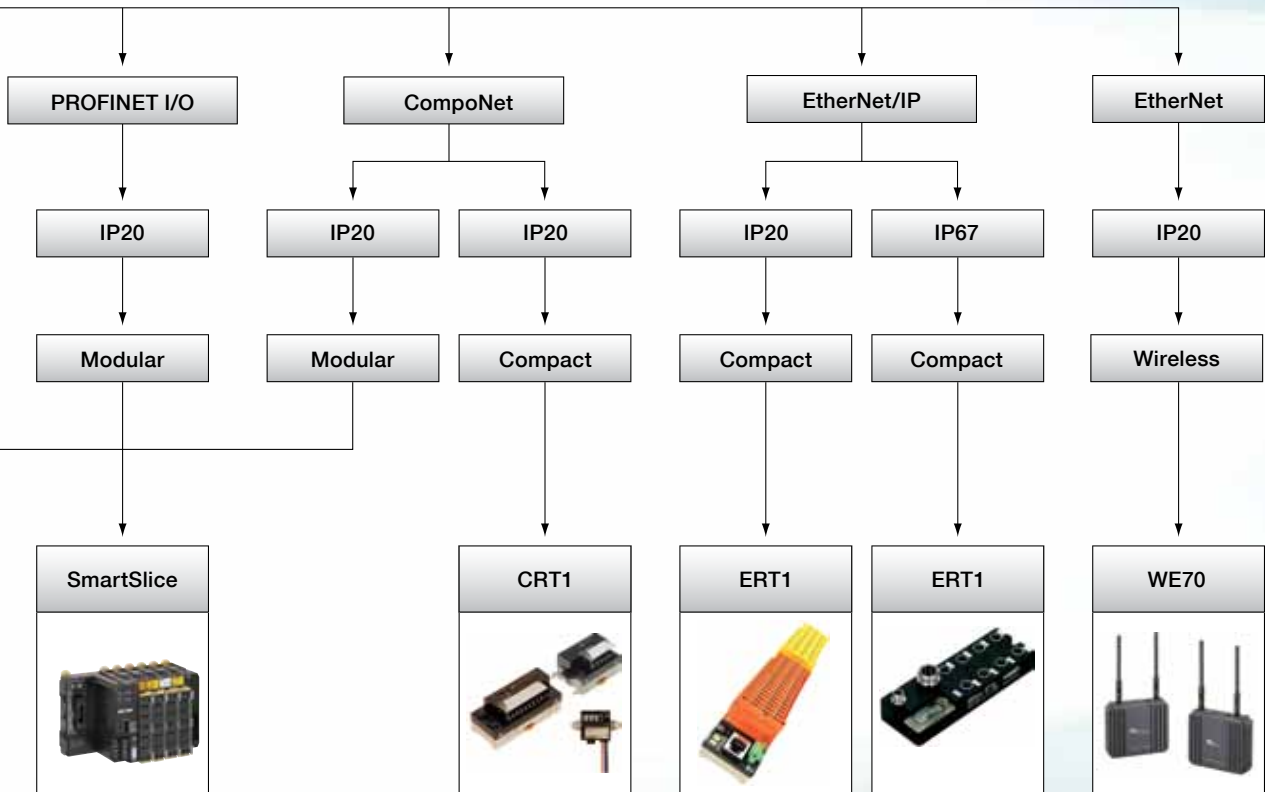











# Selection Table

	Modular I/O	Compact I/O			
					
Model	GRT-SmartSlice	DRT2-DeviceNet	CRT1-CompoNet	ERT1-EtherNet/IP	GX-EtherCAT
Network Connection	DeviceNet open-style terminal block PROFIBUS-DP 9-pin D-sub CompoNet: 4-pin system connector PROFINET-IO: 2x RJ45 MECHATROLINK-II: 2x ML-II, EtherCAT	DeviceNet with open-style push-in terminal block	Unshielded 4-wire flat cable and IDC connectors, or general-purpose 2-wire cable by screw terminals	EtherNet/IP IP67 Blocks and open-style with Cage Clamps	EtherCAT: RJ45 shielded connector x2 • CN IN: EtherCAT input • CN OUT: EtherCAT output
I/O types	<ul style="list-style-type: none"> <li>• 2/4/8-point digital I/O</li> <li>• 2-point analog I/O</li> <li>• 2-point temperature input Counter units</li> <li>• Power feed units</li> <li>• Expansion units</li> </ul>	<ul style="list-style-type: none"> <li>• 8/16 DI+extension</li> <li>• 8/16 DO+extension</li> <li>• 16 relay out</li> <li>• 4 AI (V/I, TC, Pt100)</li> <li>• 2 AO (V/I)</li> </ul>	<ul style="list-style-type: none"> <li>• 16 DI+extension</li> <li>• 16 DO+extension</li> <li>• 4 AI</li> <li>• 2 AO</li> <li>• 2 DI</li> <li>• 2 DO</li> <li>• 4 TS</li> </ul>	<ul style="list-style-type: none"> <li>• IP 67: 16 In PNP</li> <li>• IP 67: 16 Out PNP</li> <li>• Cage Clamp: 32 In PNP</li> <li>• Cage Clamp: 32 In PNP</li> <li>• Cage Clamp: 16 In &amp; Out PNP</li> </ul>	<ul style="list-style-type: none"> <li>• 16 DI, 16 DO, 16 RO, 8DI + 8DO, 32 DI, 32 DO</li> <li>• Expansion units: 8/16 DI, 8/16 DO</li> <li>• 4 Analog I (V/I, TC, Pt100)</li> <li>• 2 Analog O (V/I)</li> <li>• Encoder: Open collector</li> <li>• Line driver inputs</li> </ul>
I/O Connection technology	Push-in screwless clamp	M3 screw terminals (1 or 3-wire DI)	M3 screw terminals, eCON/RITS sensor connectors	M12 micro connector or Cage Clamp	M3 screw terminals, eCON/RITS sensor connectors
Smart features	<ul style="list-style-type: none"> <li>• I/O and power supply diagnostics</li> <li>• Operation timers and counters per I/O point</li> <li>• Analog value calculations and alarms</li> </ul>			<ul style="list-style-type: none"> <li>• I/O isolation</li> <li>• Status indication</li> <li>• Auto Baud Rate Detection</li> <li>• Input Filter</li> </ul>	<ul style="list-style-type: none"> <li>• Automatic I/O allocation at node setting</li> </ul>
Ingress Protection class	IP20 (DIN rail mounting in cabinets)			<ul style="list-style-type: none"> <li>• IP20 (DIN rail mounting in cabinets)</li> <li>• IP67, flat mount 2 - M5 screws</li> </ul>	IP20
Size in mm (HxWxD)	<ul style="list-style-type: none"> <li>• Bus coupler: 4x58x70</li> <li>• I/O units: 84x15x74</li> </ul>	<ul style="list-style-type: none"> <li>• Main units: 50x115/125x50</li> <li>• 8/16 pt. expansion: 50 x 66/50 x 94</li> </ul>	<ul style="list-style-type: none"> <li>• Main units: 50x115x50;</li> <li>• 8/16 pt. expansion: 66 x 50/94 x 50</li> <li>• 2-point slaves: 50x50x30</li> </ul>	<ul style="list-style-type: none"> <li>• IP67: 60 x 175 x 65mm</li> <li>• Cage Clamp: 57 x 245 x 57mm</li> </ul>	<ul style="list-style-type: none"> <li>• Main/analog units: 52 x 135 x 57.1</li> <li>• 3-tier units: 52 x 200 x 68.9</li> <li>• e-CON units: 52 x 215 x 68.9</li> <li>• 8/16 pt. expansion: 50 x 66/50 x 94</li> </ul>

Legend: DI = Digital Input; DO = Digital Output; AI = Analog Input; AO = Analog Output; V/I = Voltage/Current; TC = Temperature Controller; TS = Temperature Sensor Input

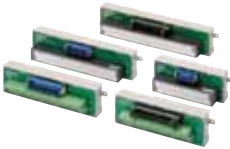
	Field I/O	Wireless I/O
		
Model	<b>DRT2-DeviceNet</b>	<b>WE70-Ethernet</b>
Network Connection	DeviceNet with M12 micro connector	Ethernet: LAN port (RJ-45 x 1)
I/O types	<ul style="list-style-type: none"> <li>• 8/16DI</li> <li>• 8/16DO</li> <li>• 8DI+8DO</li> </ul>	<ul style="list-style-type: none"> <li>• Wireless link</li> </ul>
I/O Connection technology	<ul style="list-style-type: none"> <li>• M12, 1 or 2 I/O signals per connector</li> <li>• 7/8" I/O Power connector</li> </ul>	–
Smart features	<ul style="list-style-type: none"> <li>• I/O and power supply diagnostics.</li> <li>• Operation timers and counters per I/O point</li> </ul>	<ul style="list-style-type: none"> <li>• Roaming function</li> <li>• Received Signal Strength Indicator status display</li> <li>• LAN security with encryption</li> </ul>
Ingress Protection class	IP67, flat mounting by two M5 screws	IP20 (cabinet mounting). Separate antennas (IP67) can be mounted outside the cabinet
Size in mm (HxWxD)	175 x 60 x 27.3	107.6 x 120 x 36

# Remote Terminal Blocks & Cabling

Wire Terminals				
				
Model	XW2B	XW2D	XW2C	XW2E
Type	Input/output	Input/output	Input	Input
Contacts	20, 34, 40, 60 with flat cable connector	20, 34, 40, 50 with flat cable connector	16 inputs points, NPN	16 input points
	20, 34, 50 contacts, multipole square connector			
	40 contacts, twin connectors			
	20 contacts, daisy-chain connection			
	40 contacts, PCB I/O connector			
Cables	XW2Z-F or G79-A_C	XW2Z-A, -AU,-B, -BU	XW2Z-A or XW2Z-D	XW2Z-A

Relay I/O Blocks and Bases				
				
Model	G7TC	P7TF	G70A	G70D
Type	Relay blocks	Relay bases	Relay bases	Relay output terminal
Relays	G7T relays installed	G7T relays or G3R SSRs ordered separately	G2R relays or G3R SSRs ordered separately	G6D relays or G3DZ power MOSFET relays installed
Inputs	16	16	16	–
Input type	NPN, 1 A at 24 VDC	NPN, 1 A at 24 VDC	NPN/PNP, 0.1 A at 5-24VDC	–
	NPN, 1 A at 110/120 VAC	NPN, 1 A at 110/120 VAC	–	–
	NPN, 1 A at 220/240 VAC	–	–	–
Input current	10 mA/point AC or DC	10 mA/point AC or DC	100 mA at 240 VAC/110 VDC	–
Outputs	8 or 16	8 or 16	16	16
Output type	NPN, 5 A at 12 VDC	5 A/2 A at 12 VDC	NPN, 10 A/2 A/ 1.5 A at 24 VDC	NPN, 5 A at 24 VDC
	NPN, 5 A at 24 VDC	5 A/2 A/1 A at 24 VDC	PNP, 10 A/2 A/1.5 A at 24 VDC	PNP, 5 A at 24 VDC
	PNP, 5 A at 24 VDC	PNP, 5 A/2 A/1 A at 24 VDC	–	NPN, 0.3 A at 24 VDC
	–	–	–	PNP, 0.3 A at 24 VDC
Output current	10 A at 250 VAC/30 VDC	10 A at 250 VAC/30 VDC	10 A at 380 VAC/125 VDC	5 A max. with 8 points ON
Cables	G79 series	G79 series	G79 series	G79 series

## The Smartest Modular I/O System

Omron's SmartSlice I/O system is compact, intelligent and easy.

Preventive maintenance data can be accessed using CX-Integrator software, standard PLC function blocks or NS-series Smart Active Parts.



- Easy set-up, backup and restore functions
- Detachable terminal blocks allow hot-swapping without rewiring
- 3-wire connection with 'push-in' technology, no screwdriver required for installation

## Ordering Information

Model	Function	Specifications	Model
Interface Units	DeviceNet interface unit	For up to 64 I/O units	GRT1-DRT
	CompoNet interface unit	For up to 64 I/O units (limited to 32 byte in + 32 byte out)	GRT1-CRT
	PROFIBUS-DP interface unit	For up to 64 I/O units	GRT1-PRT
	PROFINET-IO interface unit	For up to 64 I/O units	GRT1-PNT
	MECHATROLINK-II interface unit	For up to 64 I/O units (slave to Trajexia motion controller)	GRT1-ML2
	EtherCAT interface unit	Up to 64 units for Trajexia and Sysmac NJ	GRT1-ECT*
	End plate	One unit required per bus interface	GRT1-END
	End plate with memory function	Supports tool-less replacement of PROFINET-IO interface unit	GRT1-END-M
I/O units	4 NPN inputs	24 VDC, 6 mA, 3-wire connection	GRT1-ID4
	4 PNP inputs	24 VDC, 6 mA, 3-wire connection	GRT1-ID4-1
	8 NPN inputs	24 VDC, 4 mA, 1-wire connection + 4xG	GRT1-ID8
	8 PNP inputs	24 VDC, 4 mA, 1-wire connection + 4xV	GRT1-ID8-1
	4 AC inputs	110 VAC, 2-wire connection	GRT1-IA4-1
	4 AC inputs	230 VAC, 2-wire connection	GRT1-IA4-2
	4 NPN outputs	24 VDC, 500 mA, 2-wire connection	GRT1-OD4
	4 PNP outputs	24 VDC, 500 mA, 2-wire connection	GRT1-OD4-1
	4 NPN outputs	24 VDC, 500 mA, 3-wire connection	GRT1-OD4G-3
	8 PNP outputs	24 VDC, 2 A, 2-wire connection	GRT1-OD8
	8 PNP outputs	24 VDC, 500 mA, 1-wire connection	GRT1-OD8-1
	8 PNP outputs with short-circuit protections	24 VDC, 500 mA, 1-wire connection	GRT1-OD8G-1
	2 Relay outputs	240 VAC, 2A, normally-open contacts	GRT1-ROS2
	60 kHz Counter unit, NPN	A+B encoder inputs + 1 Z/control input + 1 output (NPN-type)	GRT1-CT1
	60 kHz Counter unit, PNP	A+B encoder inputs + 1 Z/control input + 1 output (PNP-type)	GRT1-CT1-1
	100 kHz Counter / Positioner unit	A+B+Z encoder inputs (line driver or 24 V selectable) + 1 control input + 2 outputs (PNP-type)	GRT1-CP1-L
	2 analog inputs, current/voltage	±10 V, 0-10 V, 0-5 V, 1-5 V, 0-20 mA, 4-20 mA	GRT1-AD2
	2 analog inputs	±10 V, 0-10 V, 0-5 V, 1-5 V	GRT1-DA2V
	2 analog outputs, voltage	0-20 mA, 4-20 mA	GRT1-DAZC
	2 Pt100 inputs	Pt100, 2-wire or 3-wire connection	GRT1-TS2P
	2 Pt1000 inputs	Pt1000, 2-wire or 3-wire connection	GRT1-TS2PK
	2 Thermocouple inputs	Types B, E, J, K, N, R, S, T, U, W, PL2, with cold junction compensation	GRT1-TS2T

Note: \* GRT1-ECT version 2.0 or higher is required when using Sysmac NJ.  
Sysmac NJ does not support counter units GRT1-CT1, GRT1-CT1-1, GRT1-CP1-L.

## Compact DeviceNet I/O Units with Extensive Diagnostic Functions

Data regarding power supply status, I/O response times, operation counters and on-time are continuously recorded and checked against user-defined limits.

- Compact, IP20 housing
- Expandable digital I/Os
- Detachable I/O terminal blocks



## Ordering Information

Unit type	Specifications	Remarks	Model
8-point PNP input unit (NPN)	24 VDC, 6 mA per point	-	DRT2-ID08-1 (DRT2-ID08)
16-point PNP input unit (NPN)	24 VDC, 6 mA per point	Expandable with one XWT unit	DRT2-ID16-1 (DRT2-ID016)
16-point PNP input unit (NPN)	24 VDC, 6 mA per point	3-tier connection for direct sensor wiring	DRT2-1D16TA-1 (DRT2-ID16TA)
8-point PNP output unit (NPN)	24 VDC, 0.5 A per point	-	DRT2-0D08-1 (DRT2-0D08)
16-point PNP output unit (NPN)	24 VDC, 0.5 A per point	Expandable with one XWT unit	DRT2-0D16-1 (DRT2-0D16)
16-point PNP output unit (NPN)	24 VDC, 0.5 A per point	3-tier connection for direct actuator wiring	DRT2-0D16TA-1 (DRT2-0D16TA)
16-point relay output unit	2 A per point, max. 8 A per common	With easy-to-replace relays, expandable with one XWT unit	DRT2-R0S16
8-input/8-output PNP (NPN)	24 VDC, input 6 mA, output 0.5 A per point	-	DRT2-MD16-1 (DRT2-MD16)
8-input/8-output PNP (NPN)	24 VDC, input 6 mA, output 0.5 A per point	3-tier connection for direct sensor/actuator wiring	DRT2-MD16TA-1 (DRT2-MD16TA)
4-Channel analog input unit	0 to 5 V, 1 to 5 V, 0 to 10 V, -10 to 10 V, 0 to 20 mA, 4 to 20 mA	Resolution 1/6000, conversion time 4 ms (4 inputs)	DRT2-AD04
4-Channel analog output unit	0 to 5 V, 1 to 5 V, 0 to 10 V, -10 to 10 V, 0 to 20 mA, 4 to 20 mA	Resolution 1/30000, conversion time 250 ms (4 inputs)	DRT2-AD04H

Unit type	Specifications	Remarks	Model
2-Channel analog unit	0 to 5 V, 1 to 5 V, 0 to 10 V, -10 to 10 V, 0 to 20 mA, 4 to 20 mA	Resolution 1/6000, conversion time 2 ms (2 outputs)	DRT2-DA02
4-Channel temperature	Platinum Resistance Thermometer types Pt100, JPt100	0.3% accuracy, conversion time 250 ms (4 inputs)	DRT2-TS04P
4-Channel temperature	Thermocouple types R, S, K, J, T, B, L, E, U, N, W and PL2	0.3% accuracy, conversion time 250 ms (4 inputs)	DRT2-TS04T
8-point PNP input expansion unit (NPN)	24 VDC, 6 mA per point	Expansion unit for DRT2 and CRT1 series	XWT-ID08-1 (XWT-ID08)
16-point PNP input expansion unit (NPN)	24 VDC, 6 mA per point	Expansion unit for DRT2 and CRT1 series	XWT-ID16-1 (XWT-ID16)
8-point PNP output expansion unit (NPN)	24 VDC, 0.5 mA per point	Expansion unit for DRT2 and CRT1 series	XWT-0D08-1 (XWT-0D08)
16-point PNP output expansion unit (NPN)	24 VDC, 0.5 mA per point	Expansion unit for DRT2 and CRT1 series	XWT-0D16-1 (XWT-0D16)



## DeviceNet I/O for Harsh Environments—Rugged I/O units for field mounting

The DRT2 slave units feature internal diagnostic and maintenance data collection, which can be accessed over the network. Power supply status, I/O response times, operation counters and on-time monitor data is available at all times, and is internally checked against user-defined limits. Maintenance warnings will be generated when limits are exceeded. Using CX-One or NS-Series HMI with Smart Active Parts for visualization, this allows more efficient system setup, commissioning and troubleshooting without any additional programming. A DeviceNet master is required when using DeviceNet I/O.

- IP67 protection, DRT2 versions are also oil- and welding-splatter proof



- M12 connectors for fast installation
- Internal circuits powered by DeviceNet; fewer connections mean less installation errors
- Smart Slave functions for diagnostics and preventive maintenance
- Indication of broken wire and short-circuit in I/O signals

## Ordering Information

Unit type	Specifications	Remarks	Model
4-point PNP input unit (NPN)	24 V, 6 mA	Separate I/O power supply connection	DRT2-ID04CL-1 (DRT2-ID04CL)
8-point PNP input unit (NPN)	24 V, 6 mA	Separate I/O power supply connection	DRT2-ID08CL-1 (DRT2-ID08CL)
8-point PNP input unit (NPN)	24 V, 11 mA, with power short-circuit and sensor disconnection detection	Unit power supply via DeviceNet cable	DRT2-ID08C-1 (DRT2-ID08C)
16-point PNP input unit (NPN)	24 V, 6 mA, 2 inputs per M12 connector	Separate I/O power supply connection	DRT2-HD16CL-1 (DRT2-HD16CL)
16-point PNP input unit (NPN)	24 V, 11 mA, 2 inputs per M12 connector, with power short-circuit and sensor disconnection detection	Unit power supply via DeviceNet cable	DRT2-HD16C-1 (DRT2-HD16C)
4-point PNP output unit (NPN)	24 V, 0.5 A per point	Separate I/O power supply connection	DRT2-OD04CL-1 (DRT2-OD04CL)
8-point PNP output unit (NPN)	24 V, 0.5 A per point	Separate I/O power supply connection	DRT2-OD08CL-1 (DRT2-OD08CL)
8-point PNP output unit (NPN)	24 V, 1.5 A per point (8 A total), with short-circuit protection + indication	Separate I/O power supply connection	DRT2-OD08C-1 (DRT2-OD08C)
16-point PNP output unit (NPN)	24 V, 0.5 A per point, 2 points per M12 connector	Separate I/O power supply connection	DRT2-WD16CL-1 (DRT2-WD16CL)
8-point input + 8-point PNP output unit (NPN)	24 V, 6 mA input, 0.5 A output per point, 2 points per M12 connector	Separate I/O power supply connection	DRT2-MD16CL-1 (DRT2-MD16CL)

Note: To order models with NPN (sinking) outputs and corresponding inputs (+V common), omit the “-1” from the model code.



## Smart CompoNet I/O

CompoNet is an open network managed by ODVA and is ideal for high-speed machine control. The special flat cable and IDC connectors make installation quick and easy. The use of repeaters allows wide-area networks with free topology, ideal for conveyor and warehouse automation.



## Ordering Information

Unit type	Specifications	Remarks	Model
2-point PNP input unit (NPN)	24 VDC, 6 mA per point	Power supply via CompoNet cable (50 cm attached)	CRT1B-ID02S-1 (CRT1B-ID02S)
8-point PNP input unit (NPN)	24 VDC, 6 mA per point	Screw terminals, common Power terminals per 8 points	CRT1-ID08-1 (CRT1-ID08)
8-point PNP input unit (NPN)	24 VDC, 6 mA per point	3 push-in terminals per I/O point (signal + power)	CRT1-ID08SL-1 (CRT1-ID08SL)
16-point PNP input unit (NPN)	24 VDC, 6 mA per point	Expandable with one XWT unit	CRT1-ID16-1 (CRT1-ID16-1)
16-point PNP input unit (NPN)	24 VDC, 6 mA per point	3 terminals per I/O point (for power distribution)	CRT1-ID16TA-1 (CRT1-ID16TA)
2-point PNP output unit (NPN)	24 VDC, 0.2 A per point	Power supply via CompoNet cable (50 cm attached)	CRT1B-OD02S-1 (CRT1B-OD02S)
8-point PNP output unit (NPN)	24 VDC, 0.5 A per point	Screw terminals, common Power terminals per 8 points	CRT1-OD08-1 (CRT1-OD08)
8-point PNP output unit (NPN)	24 VDC, 0.5 A per point	3 push-in terminals per I/O point (signal + power)	CRT1-OD08SL-1 (CRT1-OD08SL)
16-point PNP output unit (NPN)	24 VDC, 0.5 A per point	Expandable with one XWT unit	CRT1-OD16-1 (CRT1-OD16)
16-point PNP output unit (NPN)	24 VDC, 0.5 A per point	3 terminals per I/O point (for power distribution)	CRT1-OD16TA-1 (CRT1-OD16TA)
8-point SSR output unit	265 VAC, 0.3 A per point	Screw terminals, common power terminals per 8 points	CRT1-ROF08
8-point relay output unit	250 VAC, 2 A per point, 8 A per common	Screw terminals, common power terminals per 8 points	CRT1-ROS08
16-point relay output unit	250 VAC, 2 A per point, 8 A per common	8 outputs per common	CRT1-ROS16
8-point input + 8-point output unit, PNP (NPN)	24 VDC, 0.5 A per point	Screw terminals, common power terminals	CRT1-MD16-1 (CRT1-MD16)
8-point input + 8-point output unit, PNP (NPN)	24 VDC, 0.5 A per point	3 push-in terminals per I/O point (signal + power)	CRT1-MD16SL-1 (CRT1-MD16SL)
8-point input + 8-point output unit, PNP (NPN)	24 VDC, 0.5 A per point	3 terminals per I/O point (for power distribution)	CRT1-MD16TA-1 (CRT1-MD16TA)
4-Channel analog input unit	0 to 5 V, 1 to 5 V, 0 to 10 V, -10 to 10 V, 0 to 20 mA, 4 to 20 mA	Resolution 1/6000, conversion time 4 ms (4 inputs)	CRT1-AD04
2-Channel analog output unit		Resolution 1/6000, conversion time 2 ms (2 outputs)	CRT1-DA02
4-Channel Temperature	Platinum Resistance Thermometer type Pt100	0.3% accuracy, conversion time 250 ms (4 inputs)	CRT1-TS04P
4-Channel Temperature	Thermocouple types R, S, K, J, T, B, L, E, U, N, W and PL2	0.3% accuracy, conversion time 250 ms (4 inputs)	CRT1-TS04T





## Compact EtherNet/IP Slave I/O

Omron offers two EtherNet/IP I/O families to support this open, Industrial Ethernet network– IP67 blocks for on-machine mounting and cage clamp terminal blocks for easy and secure wiring. Built-in, field condition monitoring on all I/O blocks supports diagnostics for reduced-downtime. An EtherNet/IP controller is required when using EtherNet/IP I/O.

- Cage clamp terminals come in a 32-point high-density package for low cost-per-point I/O
- IP67 waterproof models eliminate separate power supply wiring for internal circuits and input devices
- Automatically collects diagnostic data to reduce downtime
- Programmable via front or DIP switches on back



## EtherNet/IP Slaves

Unit type	Appearance	Specifications	Remarks	Connection type	Model
General purpose EtherNet/IP slaves with transistor I/O		32 input points (PNP)	With detection function	Cage clamp terminals	ERT1-ID32SLH-1
		16 input points/ 16 output points (PNP)			ERT1-MD32SLH-1
		32 output points (PNP)			ERT1-OD32SLH-1
Environment resistant EtherNet/IP slaves		16 input points (PNP)	Waterproof, oil-proof, and spatter-proof construction (IP67).  With detection function	Sockets for M12 micro connector (connector that locks easily with 1/8 of a turn)	ERT1-HD16CH-1
16 output points (PNP)	ERT1-WD16CH-1				

## Compact, High-performance Remote I/O

EtherCAT is a high-performance field network able to connect drive devices, intelligent sensors and I/O devices using Ethernet technologies.

- Designed for ultra high-speed applications and response
- Real-time control synchronizes performance between slaves at 1µs max
- Built-in 2-port Ethernet switch reduces costs by allowing easy connection to multiple blocks
- EtherCAT master/slaves connect with standard Ethernet cable



## EtherCAT Remote I/O Terminals

Unit Type	Specifications	I/O type	Remarks	Model
Digital I/O Terminal 2-tier Terminal Block Type	16 input points	NPN	6.0 mA max./input (24 VDC)	GX-ID1611
		PNP		GX-ID1621
	16 output points	NPN	0.5 A/output, 4.0 A/common	GX-OD1611
		PNP		GX-OD1621
	16 output points	Relay	2 A @ 250 VAC/30 VDC	GX-OC1601
	8 input points/ 8 output points	NPN	6.0 mA max./input (24 VDC); 0.5 A/output, 2.0 A/common	GX-MD1611
PNP		GX-MD1621		
Expansion Units for 2-tier blocks	8 DC input points	NPN	6.0 mA max./input (24 VDC)	XWT-ID08
		PNP		XWT-ID08-1
	8 transistor output points	NPN	0.5 A/output, 2.0 A/common	XWT-OD08
		PNP		XWT-OD08-1
	16 DC input points	NPN	6.0 mA max./input (24 VDC)	XWT-ID16
		PNP		XWT-ID16-1
	16 transistor output points	NPN	0.5 A/output, 4.0 A/common	XWT-OD16
		PNP		XWT-OD16-1

Unit type	Specifications	I/O type	Remarks	Model
Digital I/O Terminal 3-tier Terminal Block Type	16 input points	NPN	6.0 mA max./ input (24 VDC)	GX-ID1612
		PNP		GX-ID1622
	16 output points	NPN	0.5 A/output, 4.0 A/common	GX-OD1612
		PNP		GX-OD1622
	8 input points/ 8 output points	NPN	6.0 mA max./ input (24 VDC); 0.5 A/output, 2.0 A/common	GX-MD1612
		PNP		GX-MD1622
Analog I/O Terminal 2-tier Terminal Block Type	4 analog input points	0 to 5V, 1 to 5V, 0 to 10V, -10 to +10V 4 to 20mA	500 $\mu$ s/input conversion cycle; 1/8000 resolution	GX-AD0471
	2 analog output points			GX-DA0271
Encoder Input Terminal 3-tier Terminal Block Type	2 open collector inputs	NPN	Counter phase A/B/Z; 2 latch inputs; 1 reset input	GX-EC0211
	2 line driver inputs	4 MHz input pulse frequency		GX-EC0241

## Accessories

Product name	No. of ports	Dimensions	Power supply voltage	Standards	Model
EtherCAT junction slaves	3	W25 x H90 x D78 mm	DC24V	CE, UC1	GX-JC03
	6	W48 x H90 x D78 mm	DC24V		GX-JC06

## Complete Network Mobility within a Broad Area

WE70 utilizes spread-spectrum modulation technology based on radio waves to enable communication between devices in a limited area. This gives users the mobility to move around within a broad coverage area and still be connected to the network. The smart roaming function enables high speed roaming therefore moving equipment and mobile object can communicate at high-speed.



- Conforms to IEEE 802.11a/b/g
- Same noise and environment resistance level as a PLC
- Features Omron's original security system
- Signals can be observed with LED indicators
- Conforms to radio wave standards for the USA, Europe, and Canada

## Ordering Information

Area	Type	Model
Europe	Access Point (Master)	WE70-AP-EU
	Client (Slave)	WE70-CL-EU
USA	Access Point (Master)	WE70-AP-US
	Client (Slave)	WE70-CL-US
Canada	Access Point (Master)	WE70-AP-CA
	Client (Slave)	WE70-CL-CA

## Accessories

Type	Specifications	Model
Directional Magnetic-base Antenna	1 set with two Antennas, 2.4 GHz/5 GHz Dual-band compatible	WE70-AT001H





Type	Model
DIN Rail Mounting Bracket (for TH35 7.5)	WT30-FT001
DIN Rail Mounting Bracket (for TH35 15)	WT30-FT002
Antenna Extension Cable (5 m)	WE70-CA5M

## Wire Terminals Convert I/O Wiring to Pre-Terminated Cables

- Use with Omron high-density PLC input/output modules
- Reduce labor costs
- Eliminate wiring errors
- Conserve PLC rack capacity and panel space
- Reduce overall wiring back to the PLC
- Three row and insertion type also available



## Ordering Information

Description	Appearance	Contacts	Model
M3 screws, no terminal identification strip	 XW2B-□□G4 (Regular M3 screws)	20	XW2B-20G4
		40	XW2B-40G4
		60	XW2B-60G4
M3.5 screws and protected terminal identification strip	 XW2B-□□G5 (M3.5 screws)	20	XW2B-20G5
		40	XW2B-40G5
		60	XW2B-60G5
M3 Phillips screws and protected terminal identification strip	 XW2D-□□G6 (M3 Phillips screws)	20	XW2D-20G6
ON/OFF status indicators; terminal identification strip	 XW2C-20G5-IN16 XW2C-20G6-IO16		XW2C-20G5-IN16
Use short bars to handle PLC input or output units; terminal identification strip; ON/OFF status indicators			XW2C-20G6-IO16
Three-tier block for easy wiring; equipped with common terminal on the power supply tier; terminal identification strip	 XW2E-20G5-IN16		XW2E-20G5-IN16

## Configuration

### CJ-Series Basic I/O Unit (32 points)

- CJ1W-ID231 (Fujitsu connector/input unit)
- CJ1W-OD231 (Fujitsu connector/output unit)
- CJ1W-ID232 (MIL connector/input unit)
- CJ1W-OD232 (MIL connector/output unit)

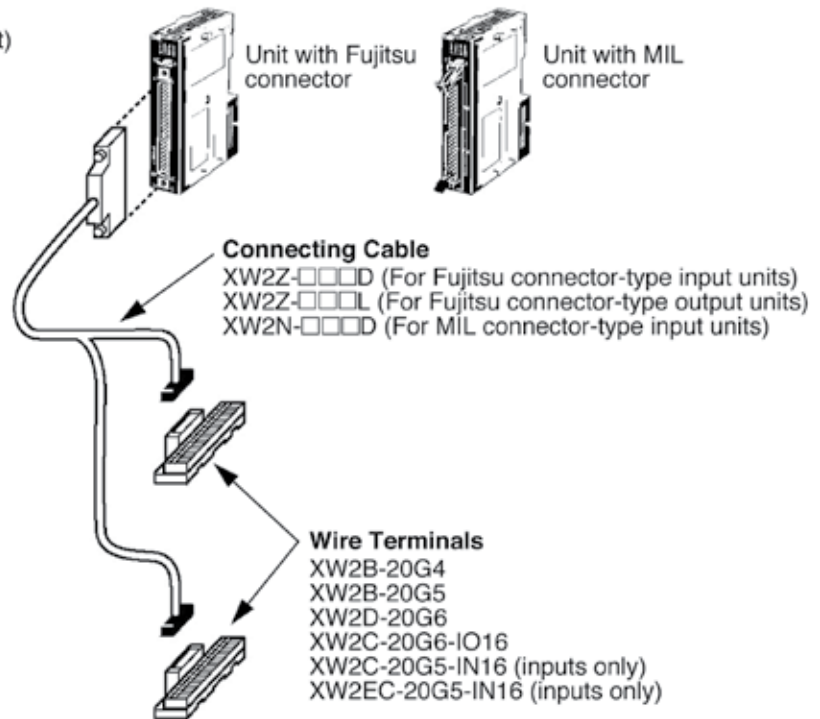

### CJ-Series Basic I/O Unit (64 points)

- CJ1W-ID261 (Fujitsu connector/input unit)
- CJ1W-OD261 (Fujitsu connector/output unit)
- CJ1W-MD261 (Fujitsu connector, I/O unit)
- CJ1W-ID262 (MIL connector/input unit)
- CJ1W-OD263 (MIL connector/output unit)
- CJ1W-MD263 (MIL connector, I/O unit)
- CJ1W-MD563 (MIL connector, I/O unit)

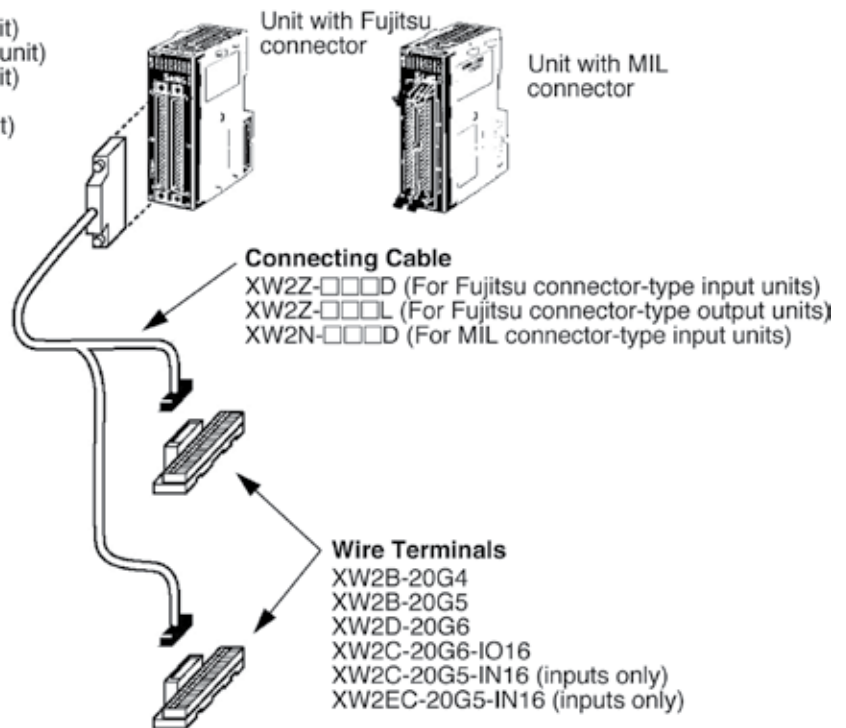

### Relay Terminals Buffer and Isolate I/O for the PLC Module

- Use with Omron high-density PLC input/output modules
- Reduce labor costs
- Use with Omron local and remote IO systems to give 120VAC inputs
- Use with Omron local and remote IO systems to give 10A independent common outputs
- Interchangeable relays allow a mix of SSR and electromechanical relays to match switching frequency of the attached device
- G79 cables provide error proof wiring between PLC module and relay terminal

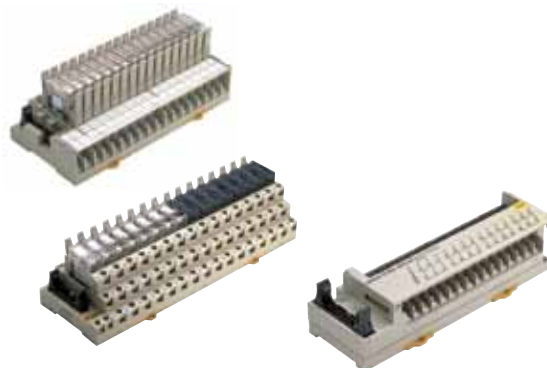

### Ordering Information

#### Relay Terminal Blocks

Description	Specifications	Relays	Model	
Relay input terminal	NPN, 10 mA/pt., AC inputs	G7T relays installed	G7TC-IA16 AC110/120V	
	NPN, 10 mA/pt., DC inputs		G7TC-ID16 DC24V	
Relay output terminal	NPN, 10 A at 250 VAC/30 VDC		G7TC-OC16 DC24V	
	PNP, 10 A at 250 VAC/30 VDC		G7TC-OC16-1 DC24V	
Relay terminal base	NPN/PNP, 100 mA at 240 VAC/110 VDC		Order separately	G70A-ZIM16-5 DC24V
	NPN, 10 A 380 VAC/125 VDC			G70A-ZOC16-3 DC24V
	PNP, 10 A 380 VAC/125 VDC	G70A-ZOC16-4 DC24V		
Covered output terminal	NPN, 5 A max. 8 pt ON	G6D relays installed	G70D-SOC16 DC24	
	PNP, 5 A max. 8 pt ON		G70D-SOC16-1 DC24	
Vertical output terminal	NPN, 5 A max. 8 pt ON		G70D-VSOC16 DC24	
	PNP, 5 A max. 8 pt ON		G70D-VSOC16-1 DC24	

#### Relay/SSRs for G70A

Type	G70A Terminal Base	Electromechanical Relay Model	Solid State Relay Model
Input	G70A-ZIM16-5 DC24V	G2R-1A3-SND DC24V	G3R-IAZR1SN AC100-240
		G2R-13-SND DC24V	G3R-IDZR1SN DC12-24
			G3R-IDZR1SN DC5
Output	NPN: G70A-ZOC16-3 DC24V PNP: G70A-ZOC16-4 DC24V	G2R-1-SND DC24	G3R-OA202SZN DC5-24
		G2R-1-SND DC12	G3R-ODX02SN DC5-24
			G3R-OD201SN DC5-24



## Contents

<b>Selection Guide</b>		D-ii
<b>Software</b>		
<b>Sysmac Studio</b>	Configure, program, simulate, and maintain an entire NJ-Series machine	D-1
<b>CX-One (Full/Lite)</b>	One software for complete system setup, design, operation, and maintenance	D-2
<b>SCADA</b>	PC-based visualization solutions	D-4

## ONE SOFTWARE



### One Software for your entire application

Applications will dictate the controller, which will dictate the software. Omron provides complete automation software suites which include all the tools necessary to create the best solution for your application, with easy licensing, free online updates, and guaranteed interoperability. For enterprise connectivity, separate Supervisory Control And Data Acquisition (SCADA) software expand data visualization and management capabilities from local to global.

- Sysmac Studio, CX-One, and CX-One Lite automation software suites provide single software part number and licensing for an entire application
- Automation software suites allow for configuration, programming, troubleshooting, and maintenance of all related hardware
- Automation software suites include Free Online AutoUpdates
- SCADA software connect Omron solutions to multiple-driver systems, with multiple databases, and web deployment

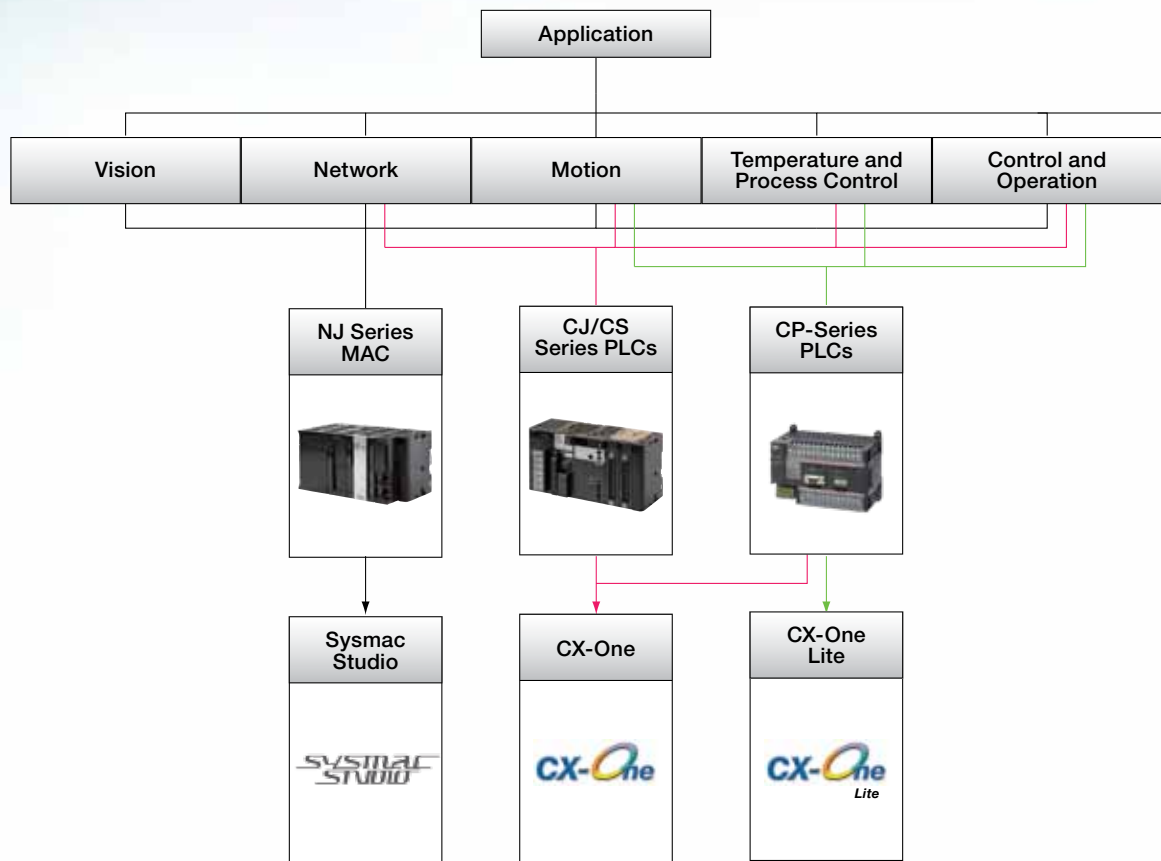

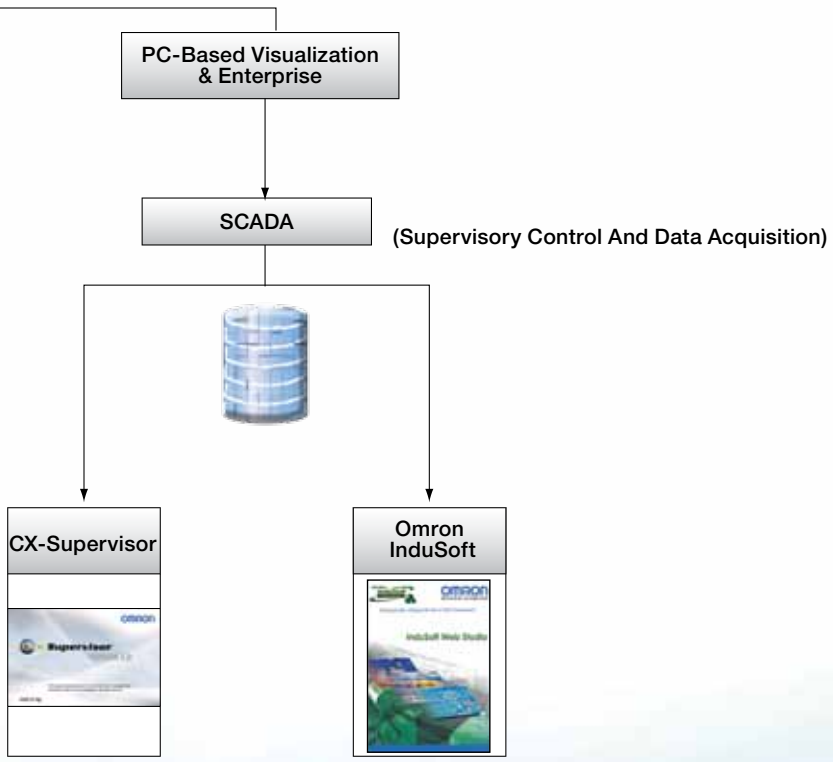

### Sysmac Studio for Machine Creators

The Sysmac Studio true Integrated Development Environment (IDE), part of the Sysmac Studio Automation Software Suite, provides a single operating environment to setup, program, debug, and maintain an entire SYSMAC NJ-Series machine solution.

- One software for configuration, logic, motion, vision, drives, networks, and I/O
- Open programming standards with extensive PLCopen motion Function Blocks, all within a true tag-based environment



- Integrated 3D motion simulation tool and graphical CAM editor
- FREE Online AutoUpdates

### PC System Requirements

OS	CPU		RAM	Display
Windows XP SP3 Windows Vista Windows 7 (32-bit or 64-bit edition)	Minimum	IBM AT or compatible with Celeron 540 (1.8 GHz) processor	2 GB	XGA 1,024 x 768, 16 million colors
	Recommended	IBM AT or compatible with Core i5 M520 (2.4 GHz) processor or the equivalent	2 GB	WXGA 1,280 x 800, 16 million colors

### Ordering Information

Number of users	License and Media model		License Only	DVD Only
	DVDs	Model	Model	Model
1	1	SYSMAC-STUDIO-1USER	SYSMAC-SE201L	SYSMAC-SE200D
3	1	SYSMAC-STUDIO-3USER	SYSMAC-SE203L	
10	3	SYSMAC-STUDIO-10USER	SYSMAC-SE210L	
30	10	SYSMAC-STUDIO-30USER	SYSMAC-SE230L	
50	16	SYSMAC-STUDIO-50USER	SYSMAC-SE250L	
Site	20	SYSMAC-STUDIO-SITE	SYSMAC-SE2XXL	
Vision edition	1	SYSMAC-STUDIO-FQM	SYSMAC-VE201L	-

**Notes:**

- Part number provides Sysmac Studio Automation Software Suite, which includes additional CX common software components for compatible products; CX-Designer, Network Configurator, etc.
- Sysmac Studio is fully compatible with CX-One V4.22 or higher.
- Sysmac Studio DVD can be installed without a license for a 30-day full functionality trial. Licenses can be purchased and registered separately.
- Software must be registered online in order to use FREE Online AutoUpdates.

### Automation Software Suite Contents

Subject	Sysmac Studio	Description
Programming	Sysmac Studio	A true Integrated Development Environment for Logic, Motion, Vision, and Simulation. Also includes equivalent functionality to CX-Drive for AC Drives & Servos.
	CX-Designer	CX-Designer is used to create screen data for NS-series Programmable Terminals.
Networks	CX-Integrator & Network Configurator EtherNet/WW	CX-Integrator & Network Configurator EtherNet/IP allow for easy network setup. They enable monitoring of the connection status, setting parameters, and diagnostics.
	CX-ConfiguratorFDT	Based on FDT/DTM technology, CX-ConfiguratorFDT can be used to configure devices from any vendor connected to a PROFIBUS network.

## The Original Automation Software Suite

The CX-One Automation Software Suite enables the user to build, configure and program networks, PLCs, HMIs, motion control systems, drives, and temperature controllers. The benefit of a single software is to reduce complexity of the configuration and allow automation systems to be programmed or configured with maximum integration and performance.

By registering in [www.Omron247.com](http://www.Omron247.com), users can benefit from free CX-One upgrades. Online updates keep CX-One current with all new modules, functions and features..



The Full CX-One software supports all Controller, HMI, Motion, Network, Temperature/Process Control, and Drive products. A separate LITE version is available for Micro-PLC users, without motion control or advanced networking.

## Ordering Information

CX-One FULL	Media	Model
Single licence	DVD	CXONE-AL01D-V_
Three user licence	DVD	CXONE-AL03D-V_
Ten user licence	DVD	CXONE-AL010D-V_
Thirty user licence	DVD	CXONE-AL030D-V_
Fifty user licence	DVD	CXONE-AL050D-V_
Site licence	DVD	CXONE-AL0XXD-V_

CX-One LITE	Media	Model
Single user licence	CD	CXONE-LT01C-V_

## Automation Software Suite Contents

Subject	CX-One Sub-Component	Description
Programming	CX-Programmer	CX-Programmer provides one common PLC software platform for all types of Omron PLC controllers – from micro PLC's up to Duplex processor systems. It allows easy conversion and re-use of PLC code between different PLC types, and the full re-use of control programs created by older generation PLC programming software.
	CX-Simulator	A debugging environment equivalent to the actual PLC system and NS HMI system environment can be achieved by simulating the operation of a CS/CJ Series PLC with a virtual PLC or NS HMI in the computer. CX-Simulator makes it possible to evaluate program operation, check the cycle time and reduce debugging time before the actual equipment is assembled.

D

# CX-ONE Software (continued)

Subject	CX-One Sub-Component	Description
Programming	CX-Designer	CX-Designer is used to create screen data for NS-series Programmable Terminals. CX-Designer can also check the operation of the created screen data on the computer. CX-Designer enables efficient development process for screen creation, simulation and project deployment. Users can develop screens more efficiently with Easy-to-use Support Software. CX-Designer has about 1,000 standard functional objects with associated graphics and advanced functions, so even first-time users can create screens easily just by arranging functional objects in a screen.
Networks	CX-Integrator & Network Configurator	CX-Integrator & Network Configurator are the main configuration software for CX-One. It enables easy performance of many operations, such as monitoring the connection status of various networks, setting parameters, and diagnosing networks.
	CX-ConfiguratorFDT	Based on FDT/DTM technology, CX-ConfiguratorFDT can be used to configure devices from any vendor connected to a PROFIBUS network. This concept will later be expanded to support many more networks using this technology.
Motion & Drives	CX-Motion	CX-Motion can be used to create, edit, and print the various parameters, position data, and motion control programs (G code) required to operate Motion Controllers, transfer the data to the Motion Control units, and monitor operation of the Motion Control units. Increase productivity in every step of the motion control process, from development of the motion control program to system operation.
	CX-Drive	The complete current range of inverters and servos is covered in this software with full access to all parameters (with 3 different operator levels available). An easy overview of parameters is also included which includes filters to show values that are: different from default, different from inverter, invalid setting. Graphical overviews are available to further assist with configuration of some more detailed parameters such as jump frequencies, v/f profiles and analogue setting.
	CX-Position	CX-Position simplifies every aspect of position control, from creating/editing the data used in Position Control units (NC units to communicating online and monitoring operation. The software is equipped with functions that can improve productivity, such as automatically generating project data and reusing existing data.
Temperature & Process Control	CX-ThermoTools	CX-ThermoTools is a configuration and monitoring product for E5CN and E5ZN-series Temperature Controllers. It provides easy setup, online data logging, and real-time monitoring. Users can easily create, edit, and batch-download parameters from a personal computer, reducing the work required to set parameters. It is possible to monitor data for up to 31 Temperature Controllers at the same time.
	CX-Process	CX-Process simplifies every aspect of loop control, from creating/transferring function blocks to running the Boards/units and debugging (tuning PID parameters, etc.) operation. Function block programs can be created easily by pasting function blocks in the window and making software connections with the mouse.

## PC-Based Visualization Solutions

Visualization software, hosted on a PC or server, is the best solution for integrating an industrial automation system into the non-industrial IT space. These solutions provide graphic interfaces for monitoring and control, as well as simplified database connectivity and remote access capabilities.

**CX-Supervisor** boasts powerful functions for a wide range of PC based HMI requirements. Simple applications can be created rapidly with the aid of a large number of predefined functions and libraries, and even very complex applications can be generated with a powerful programming language or VBScript.

**CX-Supervisor Machine Edition** supports connection of up to 15 devices and up to 500 user definable points (array = 1 point), it is flexible and powerful enough for the control and supervision of a complete machine or an entire manufacturing process.



**CX-Supervisor PLUS** handles more data, devices, pages, and database drivers than CX-Supervisor Machine, but otherwise shares all of the same power and features

**Omron InduSoft** provides multi-vendor driver and database connectivity for systems with third-party device requirements. Scalable remote access options are available over the internet, as well as redundant server technology for the highest data integrity. The runtime is scalable enough to run on any version of Windows, including Windows Embedded/CE on mobile devices using softkey licenses. USB hardkeys are optional for developers who switch between several PCs.

## Ordering Information

Description	Media	Model
CX-Supervisor Developer & runtime (no protection included)	CD	CX-SUPERVISOR-V□
CX-Supervisor Developer upgrade (no protection included, requires license of previous version)	CD	CX-SUPERVISOR-UPGR-V□□
CX-Supervisor Machine Edition runtime including USB dongle protection	CD	CX-SUPERVISOR-RUN-ME-V□□
CX-Supervisor PLUS Edition runtime including USB dongle protection	CD	CX-SUPERVISOR-RUN-PLUS-V□□
Omron InduSoft Development & Runtime License with Sysmac Gateway	CD	OMSGY-□□□□□-NT
Omron InduSoft Development Only License with Sysmac Gateway	CD	OMSGY-□□□□□-DEV
Omron InduSoft Runtime Only License with Sysmac Gateway	CD	OMSGY-□□□□□-RT
Omron InduSoft Web Thin Client (Optional Upgrade)	-	OM-□□□□-WS
Omron InduSoft Secure View Thin Client (Optional Upgrade)	-	OM-□□□□-SV
Omron InduSoft Studio Mobile Access Thin Client (Optional Upgrade)	-	OM-□□□□-SMA
Omron InduSoft Optional Hardkey License	USB	OM-USB-HK(-RT)
Omron InduSoft Optional Hardkey License	Parallel	OM-HARDKEY-RT/NT
Omron InduSoft License Level Upgrades (Development & Runtime)	-	OM-□□□□□-NT-SPUPG
Omron InduSoft License Level Upgrades (Development Only)	-	OM-□□□□□-DEV-SPUPG
Omron InduSoft License Level Upgrades (Runtime Only)	-	OM-□□□□□-RT-SPUPG
Omron InduSoft Software Version Upgrade (Development & Runtime)	-	OMSGY-□□□□□-UPG
Omron InduSoft Software Version Upgrade (Development Only)	-	OMSGY-□□□□□-DEV-UPG
Omron InduSoft Software Version Upgrade (Runtime Only)	-	OMSGY-□□□□□-RT-UPG
Omron InduSoft Web Thin Client Upgrade	-	OM-□□□□-WS-SPUPG
Omron InduSoft Secure Viewer Thin Client Upgrade	-	OM-□□□□-SV-SPUPG
Omron InduSoft Studio Mobile Access Thin Client Upgrade	-	OM-□□□□-SMA-SPUPG



## Specifications

Feature	Supervisor		Omron Indusoft
	Machine Edition	Plus	
Scripting	Yes	Yes	Yes
Recipes	Yes	Yes	Yes
Alarms	300	5000	Unlimited
Animation	Yes	Yes	Yes
Max devices (PLCs etc)	20	256	Unlimited
OPC connections	Yes	Yes	Yes
Max Points / Tags	500	8000	Dependent on License Level
Max Regular Interval Scripts	10	100	Multi-thread Simultaneous Scripts
Max Pages / Screens	100	500	Unlimited
Supported databases	MS Access	MS Access, MS Excel, MS SQL, CSV, dBase, ODBC	MS Access, MS Excel, MS SQL Server, MySQL, Oracle, Sybase
Third-party drivers	No	No	Yes, Multiple Simultaneous
Redundant server	No	No	Yes



<b>Contents</b>		
<b>Selection Guide</b>		<b>E-ii</b>
<b>Servo Drives</b>		
<b>R88D-KN</b>	Accurax G5 drives provide high response, high accuracy for wide range of applications. Available in Analog/Pulse, EtherCAT or MECHATROLINK-II versions	<b>E-1</b>
<b>R88D-KT</b>		
<b>R7D-B</b>	SmartStep2 offers advanced servo functionality in a compact design	<b>E-2</b>
<b>Servo Motors</b>		
<b>R88M-K</b>	Accurax G5 servo motors for high response, high speed and high torque	<b>E-3</b>
<b>R88M-G</b>	G-Series servo motors provide high-precision positioning with Accurax G5, and SmartStep2 servo drives	<b>E-4</b>
<b>AC Drives</b>		
<b>3G3RX</b>	Advanced open or closed loop vector control AC drive	<b>E-5</b>
<b>3G3MX2</b>	Compact open loop Sensorless vector control AC Drive	<b>E-6</b>
<b>3G3JX</b>	V/Hz AC Drive with energy saving function	<b>E-7</b>

## COMPACT PERFORMANCE SERVO SYSTEMS

Great machines are born from a perfect match between control and mechanics. Omron servos give you the extra edge to build more accurate, faster, smaller and safer machines. With the Accurax G5 series, you will achieve sub micron precision and ms settling time. Some might call it perfection, we just call it tireless innovation to help you build great machines.

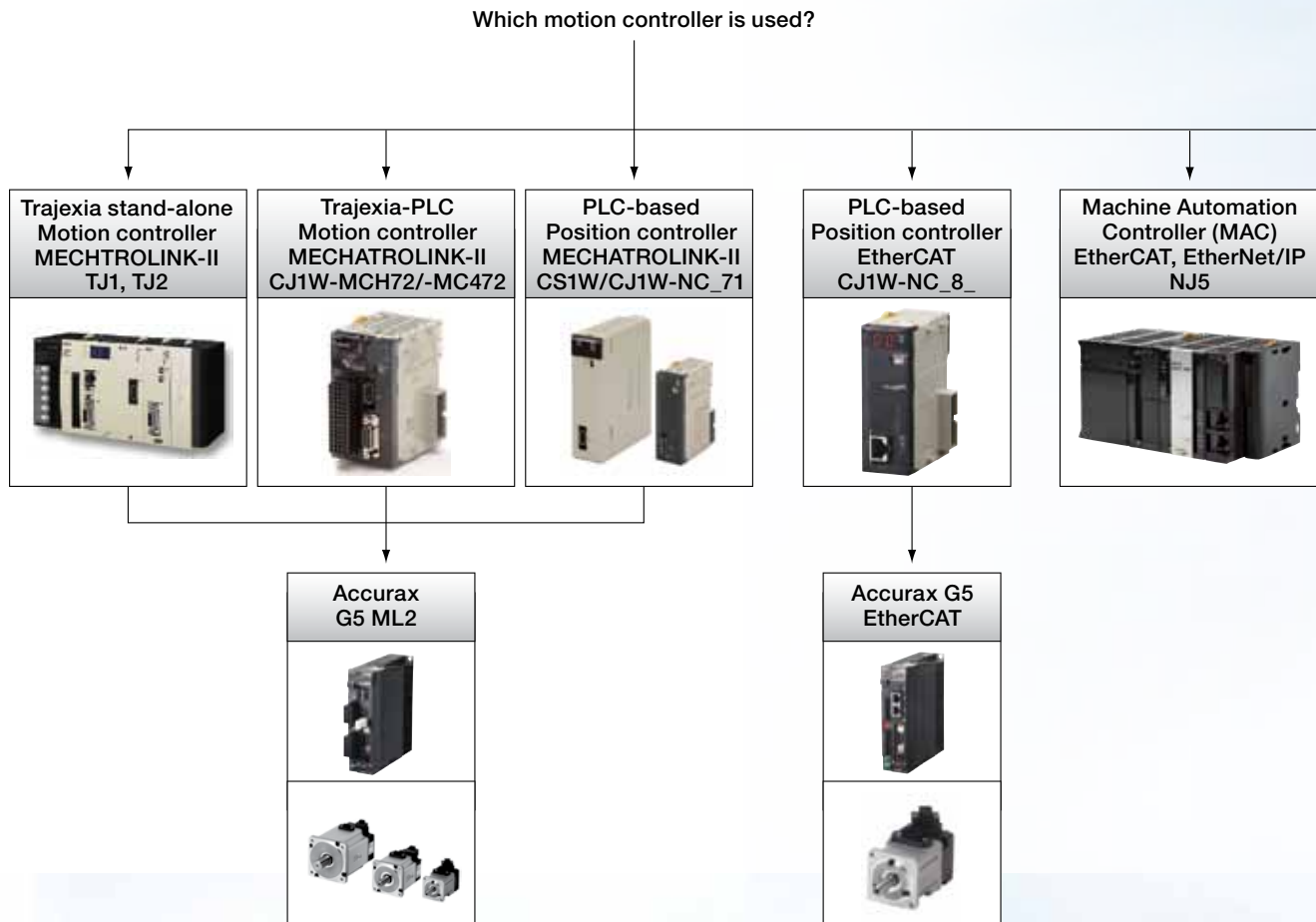

**Scalable Machine Solutions—Servo Drives**

**X-Stream:**

- EtherCAT
- MECHATROLINK-II

**Accurax G5**



50 W to 15 kW

**Mainstream:**

- Analog/Pulse train

**Accurax G5**



50 W to 15 kW

**SmartStep2**



50 W to 400 W

**PLC-based Motion Controller or other controller with analog output**



**Accurax G5 Analog/Pulse train**



**PLC-based Position Controller or other controller with pulse train output**



**Accurax G5 Analog/Pulse train**









**SmartStep2 Pulse train**





**E**

# Selection Table

Type		Servo drives			
					
Model		Accurax G5 (R88D-KN_-ECT)	Accurax G5 (R88D-KN_-ML2)	Accurax G5 (R88D-KT)	SmartStep2 (R7D-B)
Command Interface		EtherCAT	MECHATROLINK-II	Analog/Pulse train	Pulse train
Ratings	110 VAC, 1-phase	50 W to 400 W	50 W to 400 W	50 W to 400 W	50 W to 200 W
	230 VAC, 1-phase	100 W to 1.5 kW	100 W to 1.5 kW	100 W to 1.5 kW	50 W to 400 W
	230 VAC, 3-phase	2 kW to 5 kW	2 kW to 5 kW	2 kW to 5 kW	50 W to 400 W
	480 VAC, 3-phase	750 W to 15 kW	750 W to 5 kW	750 W to 15 kW	N/A
Applicable servo motor		Accurax G5 and G-Series motors	Accurax G5 and G-Series motors	Accurax G5 and G-Series motors	G-Series motors
Position control		EtherCAT (Csp,Pp, Hm)	MECHATROLINK-II Position	Pulse train	Pulse train
Speed control		EtherCAT(Csv)	MECHATROLINK-II Speed	Analog +/- 10 V or 8 internal set speeds	4 internal set speeds
Torque control		EtherCAT (Cst)	MECHATROLINK-II Torque	Analog +/- 10V	N/A
Safety approvals		Safe Torque OFF, ISO 13849-1:2008 (PL D), EN 954-1:1996 (Cat 3)	Safe Torque OFF, ISO 13849-1:2008 (PL D), EN 954-1:1996 (Cat 3)	Safe Torque OFF, ISO 13849-1:2008 (PL D), EN 954-1:1996 (Cat 3)	Safe Torque OFF, ISO 13849-1:2008 (PL D), EN 954-1:1996 (Cat 3)
Full closed loop		Built-in	Built-in	Built-in	Built-in

Type	Accurax G5 servo motors		
			
	3000 r/min motor	2000 r/min motor	1000 r/min motor
Rated speed	3,000 rpm	1,500 and 2,000 rpm	1,000 rpm
Maximum speed	4,500 to 6,000 rpm	3,000 rpm	2,000 rpm
Rated torque	0.16 Nm to 15.9 Nm	1.91 Nm to 95.9 Nm	8.59 Nm to 57.3 Nm
Sizes	50 W to 5 kW	400 W to 15 kW	900 W to 6 kW
Applicable servo drive	Accurax G5 servo drive	Accurax G5 servo drive	Accurax G5 servo drive
Encoder resolution	20-bit incremental/ 17-bit absolute	20-bit incremental/ 17-bit absolute	20-bit incremental/ 17-bit absolute
IP rating	IP67	IP67	IP67

Type	G-Series servo motors Cylindrical Type	G-Series servo motors Flat Type
		
	<b>3000 r/min motor</b>	<b>3000 r/min motor</b>
Rated speed	3,000 rpm	3,000 rpm
Maximum speed	5,000 rpm	5,000 rpm
Rated torque	0.16 Nm to 1.3 Nm	0.32 Nm to 1.3 Nm
Sizes	50 W to 400 W	100 W to 400 W
Applicable servo drive	Accurax G5 Servo Drives and SmartStep2	Accurax G5 Servo Drives and SmartStep2
Encoder resolution	10,000 pulses/revolution	10,000 pulses/revolution
IP rating	IP65	IP65

## HARMONIZED MOTOR AND MACHINE CONTROL

The 3G3 AC Drives are a family of high performance variable frequency drives suitable for asynchronous induction motors in a variety of industrial applications ranging from conveyors, pumps and fans to winders, mixers, and extruders. Dual rating with high starting torque and built-in EMC filters are among some of the differentiating features.

Ready to integrate with many communication options and built-in safety, the MX2 expands capabilities specifically for machine control as part of a system or a stand-alone device. Basic positioning functionality reduces components and complexity for simple indexing or more advanced packaging machinery.

### Scalable Machine Solutions-Inverters

#### X-Stream:

- V/Hz control
- Sensorless vector control
- Closed loop control

#### Mainstream:

- V/Hz control
- Sensorless vector control

#### Lean:

- V/Hz control

#### RX series



Up to 132 kW  
(175HP)

#### MX2 series



Up to 15 kW  
(20HP)

#### JX series



Up to 7.5 kW  
(10HP)

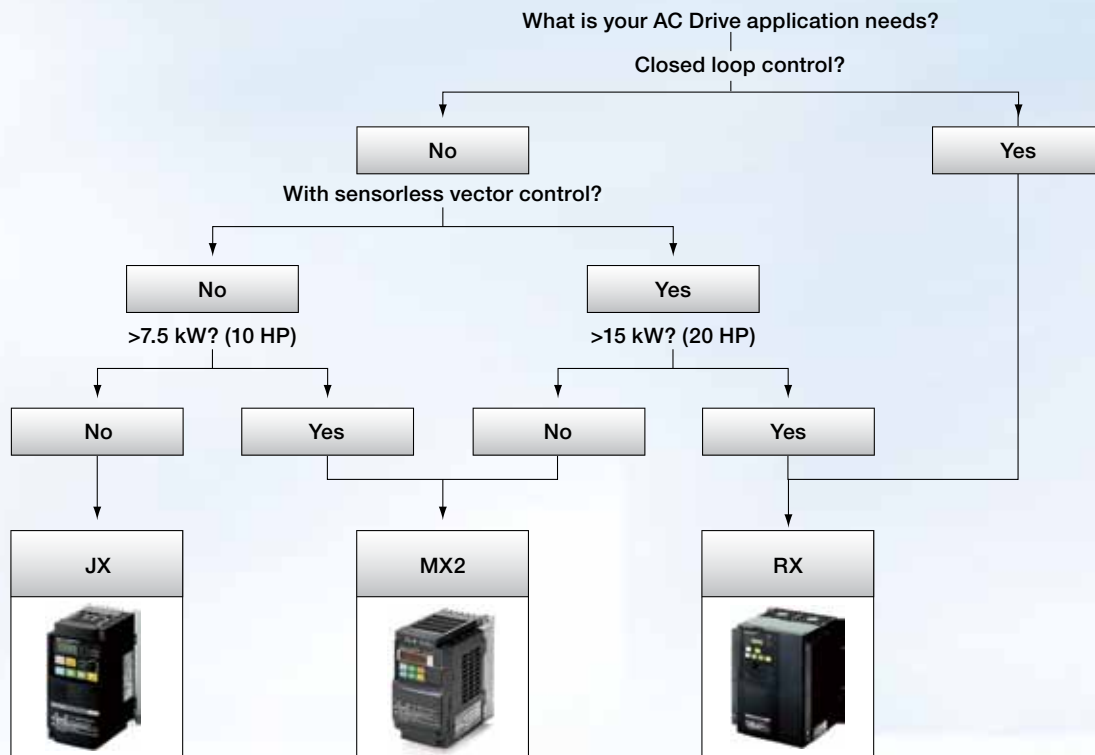

# Selection Table

Model	JX	MX2	RX
			
	<b>Compact and complete</b>	<b>Born to drives machines</b>	<b>Customized to your machine</b>
230 V, 1-phase	0.2 kW to 2.2 kW (1/4 HP to 3 HP)	0.1 kW to 2.2 kW (1/8 HP to 3 HP) <sup>2</sup>	N/A
230 V, 3-phase	0.2 kW to 7.5 kW (1/4 HP to 10 HP) <sup>1</sup>	0.1 kW to 15 kW (1/8 HP to 20 HP) <sup>2</sup>	0.4 kW to 55 kW (1/2 HP to 75 HP) <sup>1</sup>
480 V, 3-phase	0.2 kW to 7.5 kW (1/2 HP to 10 HP) <sup>1</sup>	0.4 kW to 15 kW (1/2 HP to 20 HP) <sup>2</sup>	0.4 kW to 132 kW (1/2 HP to 175 HP) <sup>1</sup>
Application	General purpose built-in communications	Harmonized motor and machine control	High Performance, built-in know-how functionality
Control method	V/Hz control	Open loop V/Hz or Sensorless vector control	Open loop V/Hz or Sensorless vector control; Closed loop vector control
Torque features	• 150% at 3 Hz	• 200% at 0.5 Hz	• 200% at 0.0 Hz (CLV) • 200% at 0.3 Hz (OLV)
Connectivity	• Modbus (built-in)	• Modbus (built-in)  Options: • DeviceNet • PROFIBUS • MECHATROLINK-II • EtherCAT • CompoNet • EtherNet/IP	• Modbus (built-in)  Options: • DeviceNet • PROFIBUS
Logic programming	N/A	Standard Firmware	Standard Firmware
Simple positioning	N/A	Open loop	Closed loop

1. EMC filter built-in  
2. Dual rating







# Accurax G5 Servo Drives

## R88D-KN□□□-ML2/ECT, R88D-KT□



**Accurate motion control in a compact size servo drive family. MECHATROLINK-II or EtherCAT motion bus and safety built in.**

- MECHATROLINK-II, EtherCAT, and Analog/Pulse servo drive models
- Safety conforming IEC61800-5-2 (STO), EN 954-1 (CAT3), EN61508 SIL2, and ISO13849-1 (PLc-d)
- Speed loop frequency response of 2 kHz
- High resolution serial encoder for greater accuracy provided by 20 bit encoder
- External encoder input for full close loop
- Real time auto-tuning
- Advanced tuning algorithms (Anti-vibration function, torque feed-forward, disturbance observer)



### Ratings

- 120 VAC Single-phase 50 W to 400 W
- 230 VAC Single-phase 100 W to 1.5 kW
- 230 VAC Three-phase 2 kW to 5 kW
- 480 VAC Three-phase 750 W to 15 kW

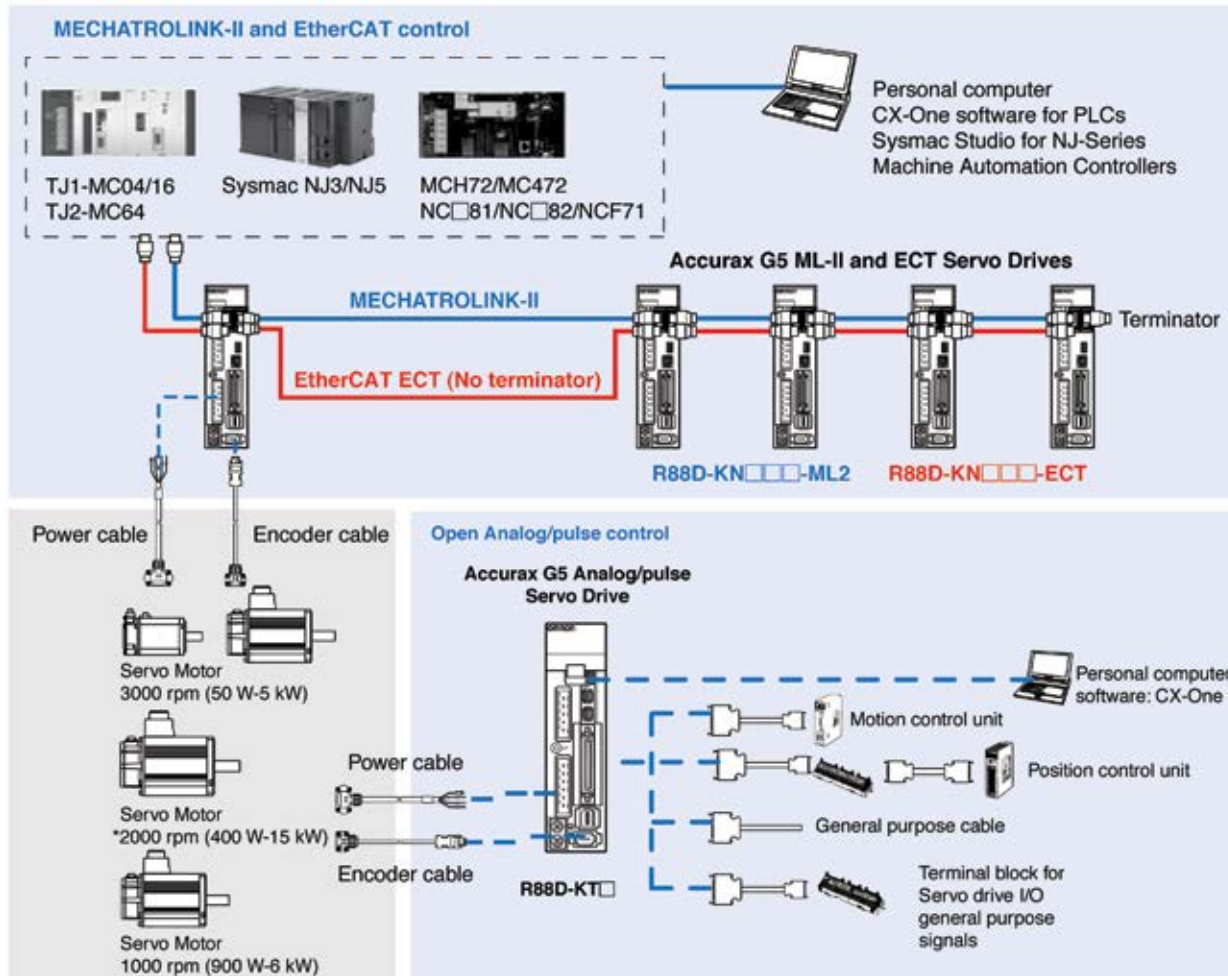

\*7.5/11/15 kW are 1500 RPM

### Another step forward in drive simplicity.

- On-line auto-tuning and easy set-up
- Ultra-compact size. The footprint is only 48% that of the SmartStep series
- Two torque limit settings
- Electronic gear, four internal speed settings and wide range of pulse settings
- Adaptive filters for suppression of vibration and resonance
- Configuration and commissioning using CX Drive-software

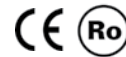

### Ratings

- 120 VAC single-phase 50 W to 200 W
- 230 VAC Single-phase 50 W to 400 W
- 230 VAC three-phase 50 W to 400 W

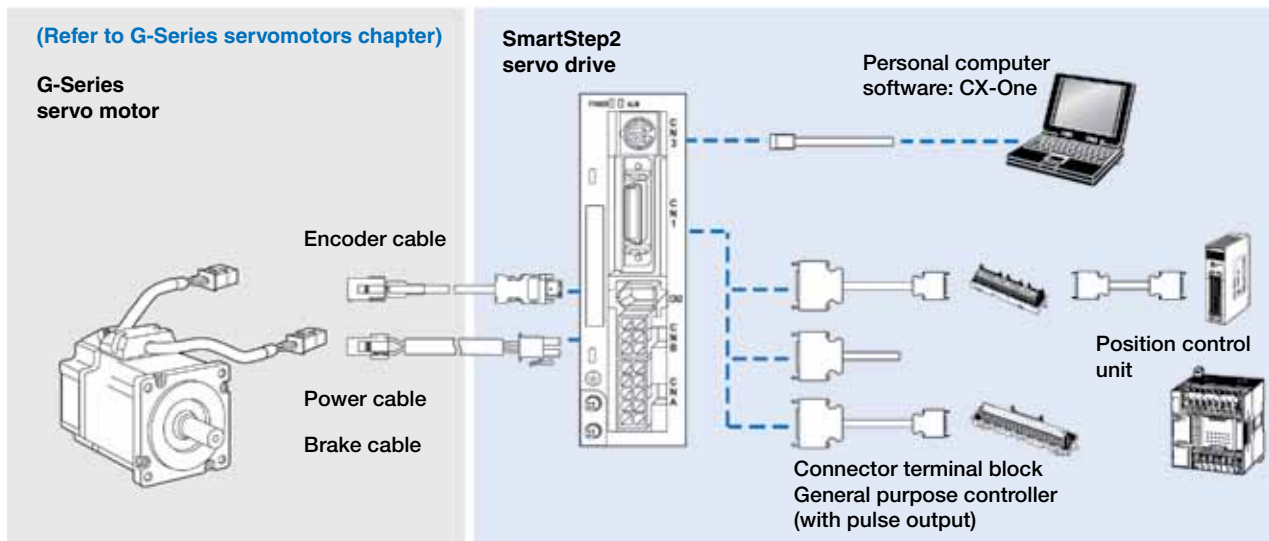

### Servo family for accurate motion control. High response, high speed and high torque.

- Peak torque 300% of rated torque for 3 seconds or more depending on model
- High resolution 20 bit encoder enables precise and accurate motor control
- IP67 protection in all models
- Ultra-light and compact size motor
- Low speed ripple and low torque ripple due to low torque cogging
- Various shaft, brake and seal options



### Ratings

- 120 VAC from 50 W to 400 W
- 230 VAC from 50 W to 5 kW
- 480 VAC from 400 W to 15 kW

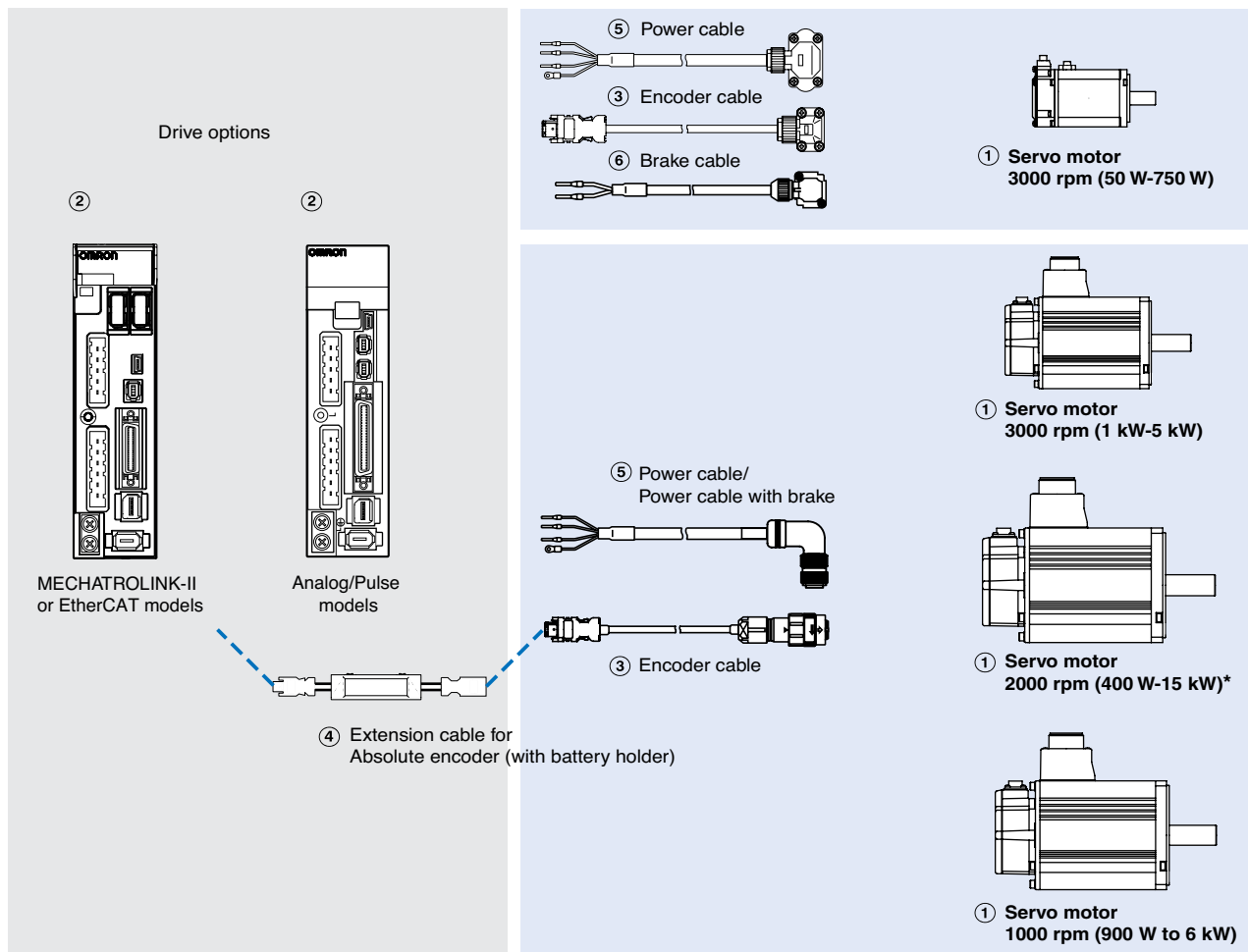

**Note:** The symbols ①②③... show the recommended sequence to select the servo motor and cables.  
\* 7.5/11/15kW are 1500 RPM



### A wide range of compact servomotors to meet all application needs

- Peak torque 300% of continuous torque for 3 seconds or more depending on model
- Servomotors supported by SmartStep2, and Accurax G5 servo drives
- Cylindrical and Flat servomotors types are available
- Encoder accuracy of 10,000 step/rev as standard
- IP65 as standard and shaft oil seal available
- Motors with brake as option



### Ratings

- 120 VAC single-phase 50 W to 200 W
- 230 VAC single-phase 50 W to 400 W
- 230 VAC three-phase 50 W to 400 W

#### ① G-Series Cylindrical type Servo motor

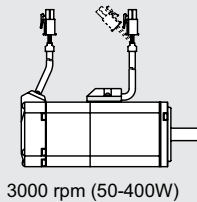

3000 rpm (50-400W)

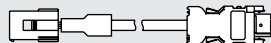

③ Encoder cable

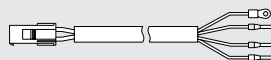

④ Power cable

#### ① G-Series Flat type Servo motor

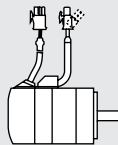

3000 rpm (100-400 W)



⑤ Brake cable

#### ② SmartStep 2 Servo drive Servo Drive controlled by pulses

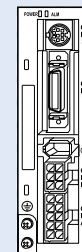

**Note:** The symbols ①③④⑤.... show the recommended sequence to select the servo motor and cables.

## Customized to your machine

- Up to 132 kW (175 HP)
- High-starting torque in open loop; 200% at 0.3 Hz
- Full torque at 0 Hz in closed loop
- V/Hz or Sensorless vector closed-loop control
- Built-in EMC filter, logic programmability, and application functionality
- Simple positioning functionality
- Automatic energy saving
- Micro-surge voltage suppression
- Modbus RS485 (options for other networks)



## Ratings

- 230 V Class three-phase, 0.4 to 55 kW (1/2 to 75 HP)
- 480 V Class three phase, 0.4 to 132 kW (1/2 to 175 HP)

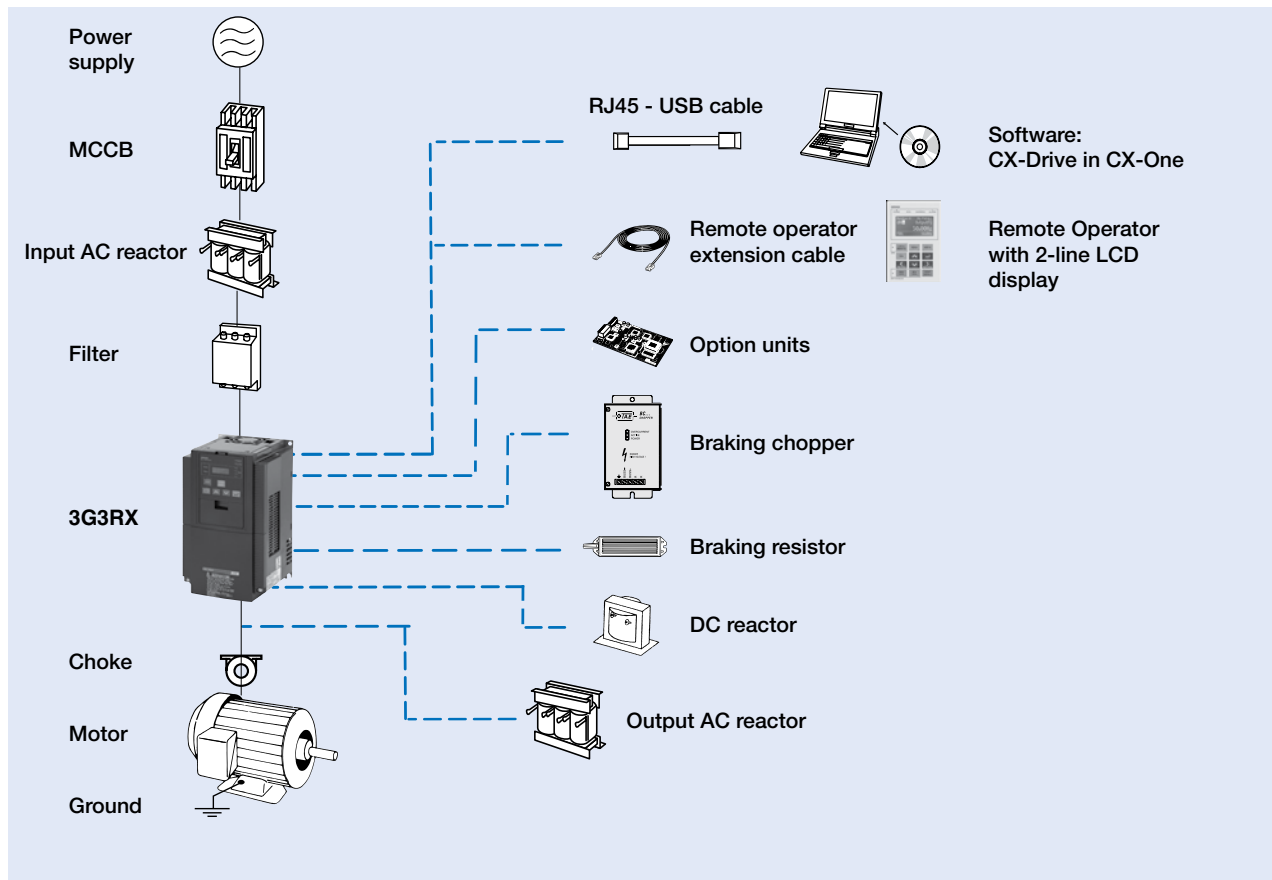

E

## Born to drive machines

- V/Hz or Sensorless vector control
- High starting torque: 200% at 0.5 Hz
- Double rating VT 120% for 1 min and CT 150% for 1 min
- Speed range up to 1000 Hz
- One parameter auto-tuning
- Torque control in open loop vector
- Simple positioning functionality
- Built-in application functionality (i.e. brake control)
- Flow-chart programming (5 tasks, 1000 lines) as standard
- Safety embedded compliant with ISO13849-1 (double input circuit and external device monitor EDM)
- USB port for PC programming
- 24 VDC backup supply for control board
- Fieldbus communications: EtherNet/IP, DeviceNet, Profibus, CompoNet, EtherCAT, MECHATROLINK-II, Modbus
- PC configuration tool: CX-Drive



## Ratings

- 230 V Class single-phase 0.1 to 2.2 kW (1/8 to 3 HP)
- 230 V Class three-phase 0.1 to 15.0 kW (1/8 to 20 HP)
- 480 V Class three-phase 0.4 to 15.0 kW (1/2 to 20 HP)

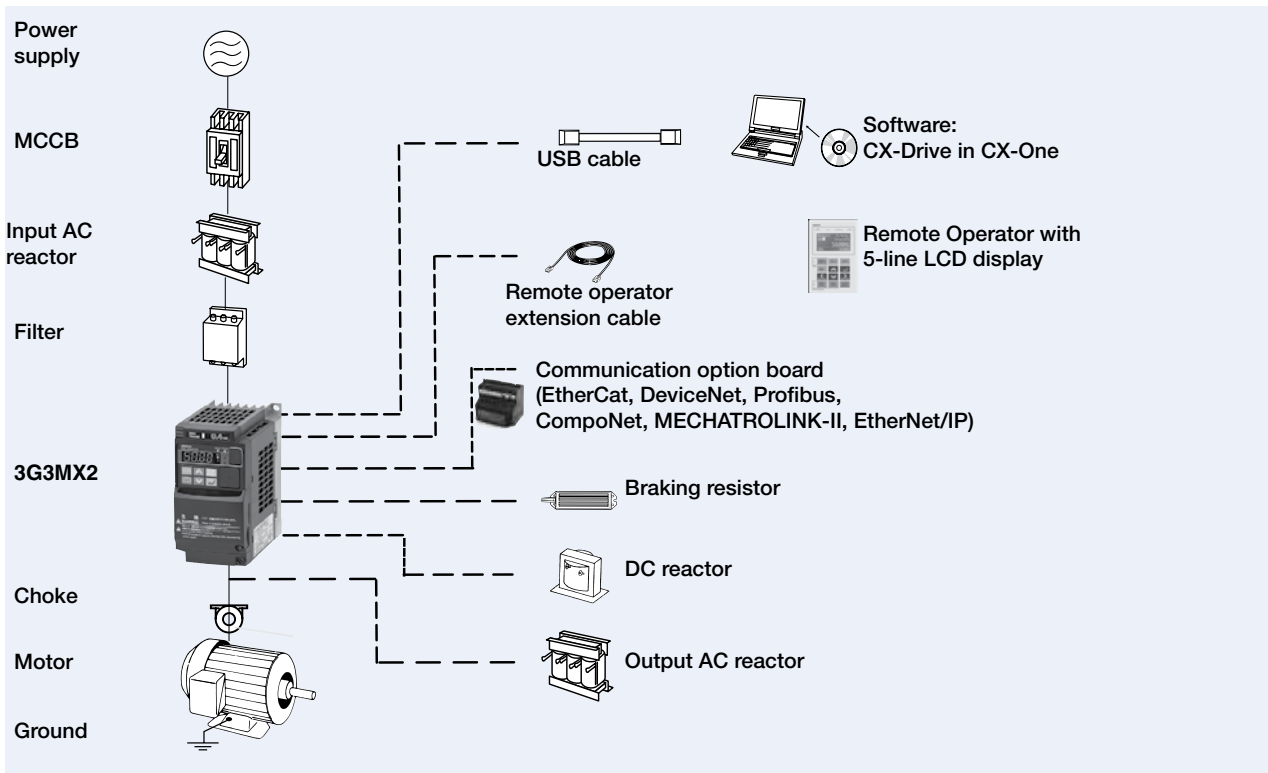

## Compact & Complete

- V/Hz controlled inverter
- Side by side mounting
- Built-in Radio Noise Filter (3 phase model only)
- Built-in RS-485 Modbus
- Overload detection function (150% for 60s)
- PID
- Micro-surge voltage suppression
- Automatic energy saving
- Emergency shut-off
- Second motor setting
- Auto carrier-frequency reduction
- PTC thermistor input
- Cooling fan switch control
- PC configuration tool; CX-Drive



## Ratings

- 230 V Class single-phase, 0.2 to 2.2 kW (1/4 to 3 HP)
- 230 V Class three-phase, 0.2 to 7.5 kW (1/4 to 10 HP)
- 480 V Class three-phase, 0.4 to 7.5 kW (1/2 to 10 HP)

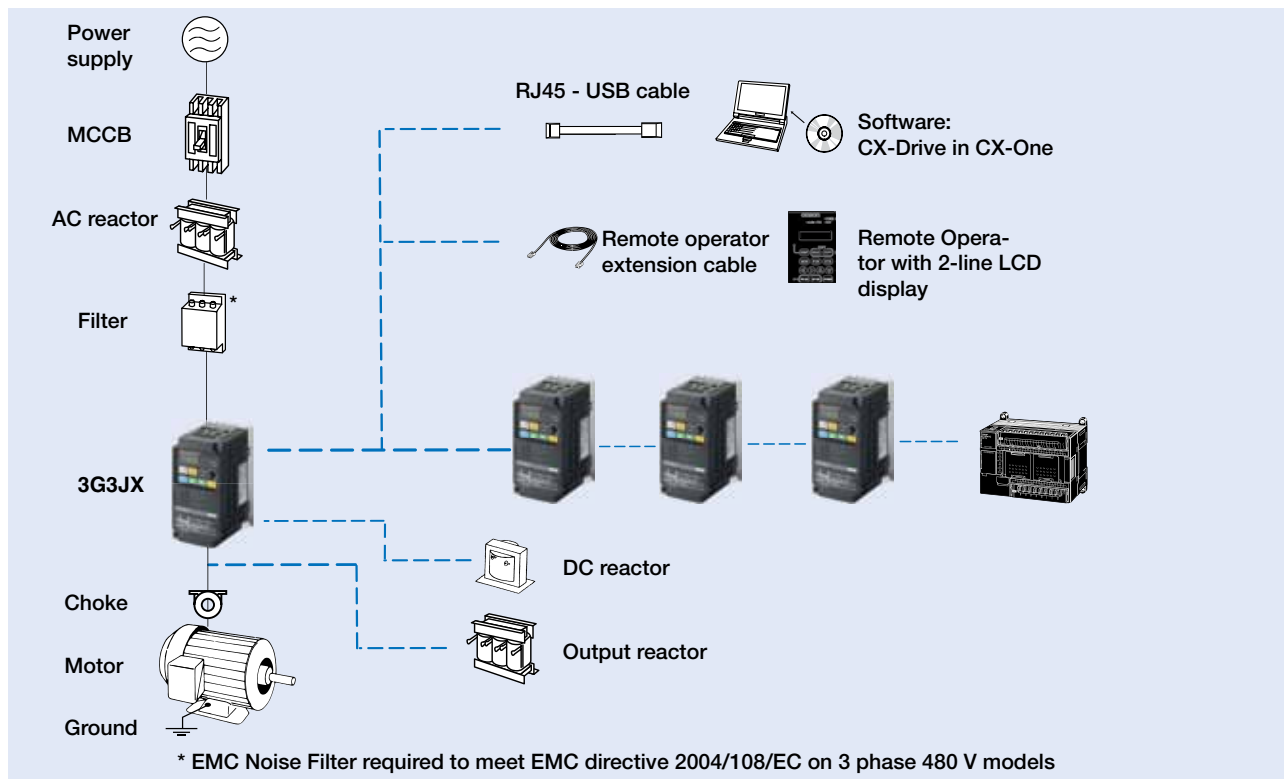

E





<b>Contents</b>		
<b>Selection Guide</b>		F-ii
<b>Motion Controllers</b>		
<b>Sysmac NJ5, NJ3</b>	Machine Automation Controller with advanced motion at the core	F-1
<b>TJ1, TJ2</b>	Trajexia Motion Controller	F-2
<b>CJ1W-MC72□</b>	Motion Control Unit, MECHATROLINK-II, for CJ PLCs	F-3
<b>CJ1W-NC□8□</b>	Position Control Unit, EtherCAT, for CJ PLCs	F-4
<b>CJ1W-NC□71</b>	Position Control Unit, MECHATROLINK-II, for CJ PLCs	F-5
<b>C200H-MC402-E</b>	Motion Control Unit, Analog, for CS PLCs	F-6
<b>CS1W-MC□21</b>	Motion Control Unit, Analog, for CS PLCs	F-7
<b>CJ1W-NC□□3</b>	Position Control Unit, Pulse Output, for CJ PLCs	F-8
<b>CS1W-NC□□3/ C200HW-NC□□</b>	Position Control Unit, Pulse Output, for CS PLCs	F-9
<b>H8PS</b>	Stand-alone Cam Positioner	F-10
<b>Rotary Encoders</b>		
<b>E6C3-A</b>	Absolute encoder, 50 mm dia.	F-11
<b>E6CP-A</b>	Absolute encoder, 50 mm dia.	F-12
<b>E6F-A</b>	Absolute encoder, 60 mm dia.	F-13
<b>E6A2-C</b>	Incremental encoder, 25 mm dia.	F-14
<b>E6B2-C</b>	Incremental encoder, 40 mm dia.	F-15
<b>E6C3-C</b>	Incremental encoder, 50 mm dia.	F-16
<b>E6D-C</b>	Incremental encoder, 40 mm dia.	F-17
<b>E6F-C</b>	Incremental encoder, 60 mm dia.	F-17



## TOTAL FREEDOM IN MOTION CONTROL

Machine builders and OEMs that require motion and machine control systems find high value and flexibility in Omron's Scalable Machine Solutions. From single-function compact machines to the most flexible production cells, Omron helps you turn ideas into machines that work. We support simple point-to-point positioning to synchronized motion control from our portfolio of robust Machine Automation Controllers (MAC), PLCs, and stand-alone Motion Controllers that are discretely wired or network connected.

### Scalable Machine Solution – Controllers:

- Lean Automation: CP1 PLC Pulse Output for Position Control
- Mainstream Automation: CJ Hybrid PLC and Motion with Networked Control
- X-Stream Automation: TJ Trajexia up to 64 synchronized axes for X-Stream Motion Control.  
Sysmac NJ up to 64 synchronized axes for X-Stream Machine Control

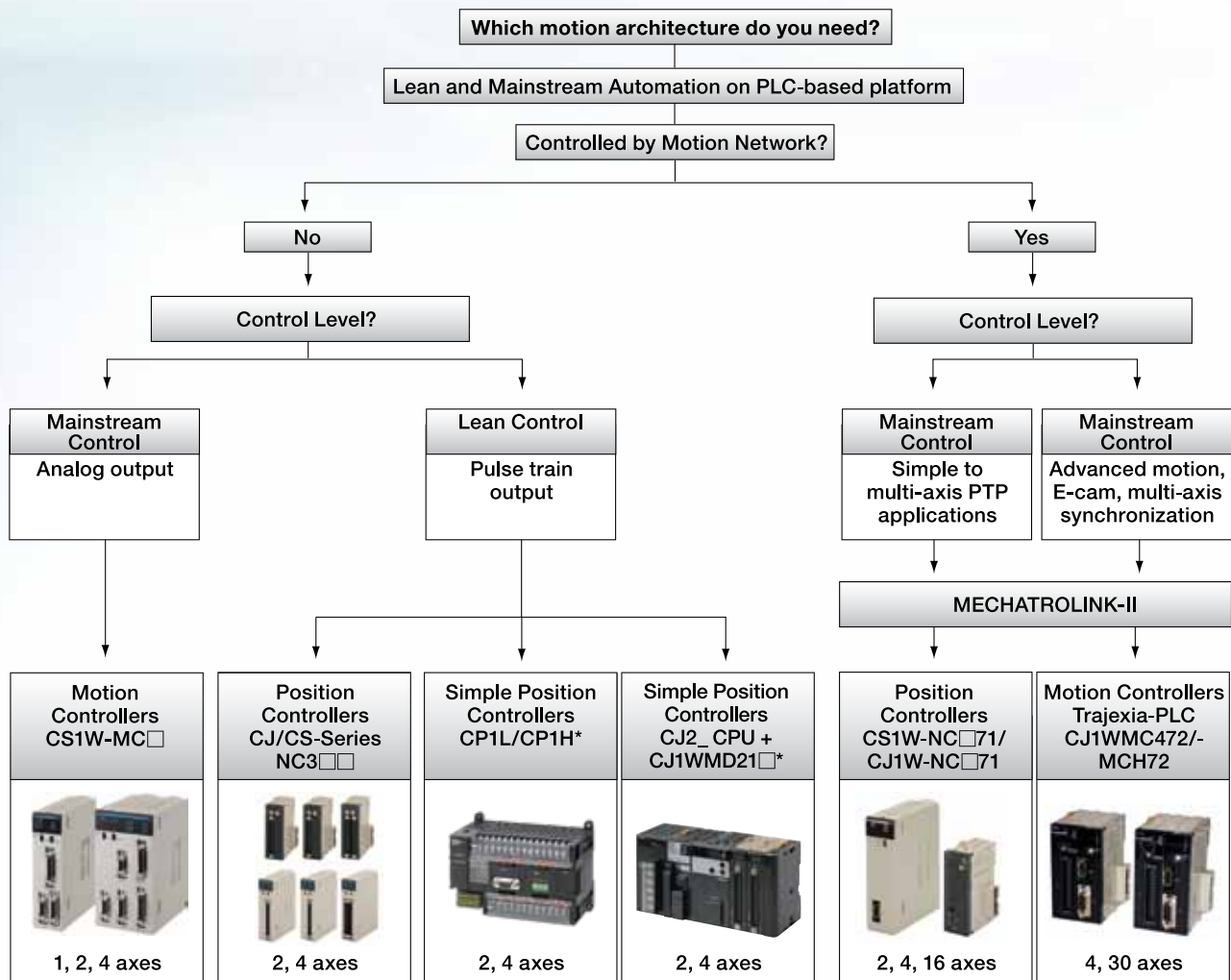

\* See Section A

# Scalable Machine Solution-Controller



Lean Automation  
CP1 PLC with built-in pulse output for position control



Mainstream Automation  
CJ series hybrid PLC and motion with networked control





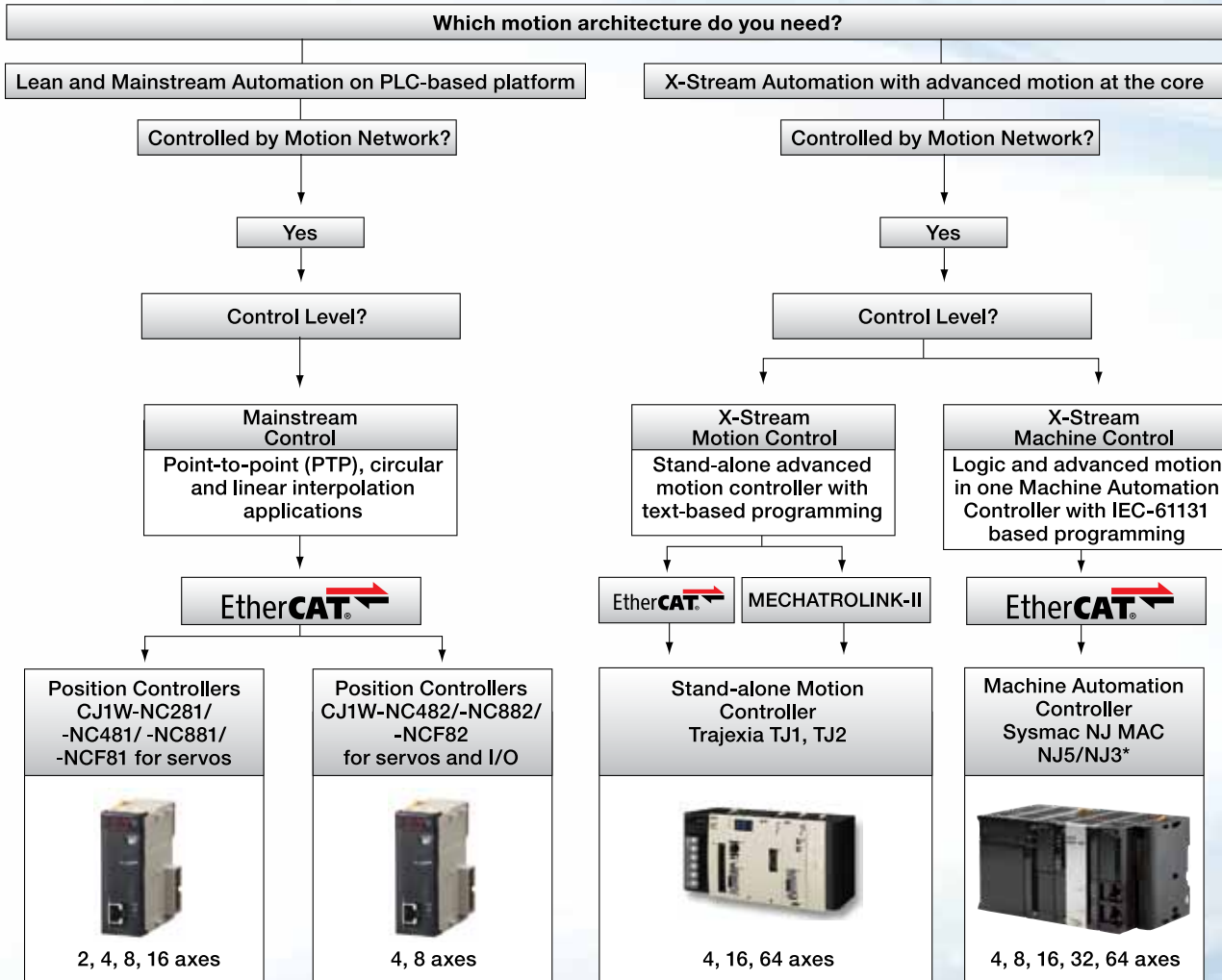

X-Stream Automation  
Sysmac NJ and TJ Trajexia stand-alone for complete machine automation control for up to 64 axes synchronized.





F

# Selection Table



Type	Networked Motion Controllers			
				
Model	Sysmac NJ501/NJ301*	Trajexia TJ1, TJ2	CJ1W-NC□81/ -NC□82	Trajexia CJ1W-MCH72/-MC472
Description	MAC based controller with built-in advanced multi-axis coordinated motion control for complete machine automation control. IEC-61131 Programming. EtherNet/IP built-in. EtherCAT built-in	Advanced stand-alone motion controller. TJ2 has EtherNet/IP built-in.	PLC based positioning controller	PLC-based advanced multi-axis motion controller
Scalable Machine Solution level	X-Stream Machine Control	X-Stream Motion Control	Mainstream Motion Control	Mainstream Motion Control
Axes control method	• EtherCAT built-in	• EtherCAT motion bus • MECHATROLINK-II motion bus • Analog output • Pulse-train output	• EtherCAT motion bus	• MECHATROLINK-II motion bus
Number of axes	4, 8, 16, 32, 64 CPU versions	4, 16, 64	2, 4, 8, 16	4, 30
Applicable servo drive	Accurax G5 series (R88D-KN□□-ECT)	Accurax G5 series (R88D-KN-ECT/ML2)	Accurax G5 series (R88D-KN□□-ECT)	Accurax G5 series (R88D-KN-ECT/ML2)
Application	• Complete Machine Control / Cell Control • Advanced Motion • E-cam, gearing, circular/linear Interpolation • Registration & Phase shift on-the-fly • Fastest Update 32 axis in 1 ms	• Advanced motion • E-cam and gearing • Phase shift • Registration	• Simple point-to-point • Linear & circular interpolation • Registration • PLS • Faster tact time	• Advanced motion • E-cam and gearing • Phase shift • Registration
Servo control mode	Position, Speed, and Torque	Position, speed and torque	Position, speed and torque	Position, speed and torque
Platform series	Sysmac NJ-Series MAC (Machine Automation Controller) with built-in logic & motion, built-in real-time network ) EtherCAT) for motion and I/O and built-in data network (EtherNet/IP)	Stand-Alone Motion Controller. TJ2 has EtherNet/IP built-in	CJ-Series PLC with Positioning Motion Module(s). CJ2 has EtherNet/IP built-in	CJ-Series PLC with Trajexia Motion Module. CJ2 has EtherNet/IP built-in

\* Note: See section A for details and selection

# Motion Controllers

Type	Networked Motion Controllers	Hard Wired Position Controllers	
			
Model	CJ1W-NC□71/ CS1W-NC□71	CJ2M-MD21*	CP1L / CP1H
Description	PLC-based point-to-point positioning controller	PLC-based	Micro PLC-based
Scalable Machine Solution level	Mainstream Motion Control	Lean Control	Lean Control
Axes control method	• MECHATROLINK-II motion bus	• Pulse train output	• Pulse train output
Number of axes	2, 4, 16	2, 4	2, 4
Applicable servo drive	Accurax G5 series (R88D-KN□□ML2)	SmartStep2 (R7D-B), Accurax G5 series (R88D-KT)	SmartStep2 (R7D-B), Accurax G5 series (R88D-KT)
Application	• From simple point-to-point to multi-axis point-to-point coordinated systems	• Point-to-point Indexing • Interrupt feeding	• Point-to-point Indexing
Servo control mode	Position, speed and torque	Position	Position
Platform series	CJ and CS1 Series PLC with Positioning Motion Module(s). CJ2 has EtherNet/IP built-in	CJ2-Series PLC with simple positioning module	CP1-Series Micro PLC with simple positioning capabilities built-in

\* Note: See section A for details and selection

Type	Hard Wired Motion Controllers	
		
Model	CS1W-MC_21	CJ1W-NC_3/ CS1W-NC_3
Description	PLC-based motion controller with multi-tasking. G-code programming capability	PLC-based, point-to-point positioning controller
Scalable Machine Solution level	Mainstream Motion Control	Mainstream Position Control
Axes control method	• Analog output	• Pulse train output
Number of axes	2, 4	1, 2, 4
Applicable servo drive	Accurax G5-Series (R88D-KT)	SmartStep2 (R7D-B), Accurax G5-Series (R88D-KT)
Application	• Point-to-point with complex interpolations	• Point-to-point applications
Servo control mode	Position, speed	Position
Platform series	CS-Series PLC with motion module(s)	CJ- and CS-Series. CJ2 has EtherNet/IP built-in

## ACCURACY AND ROBUSTNESS MADE RELIABLE



Close the loop – angle, position and velocity on hand

Rotary encoders create information which represent the movement of your application. To meet challenging demands, Omron offers a wide range of absolute and incremental encoders.

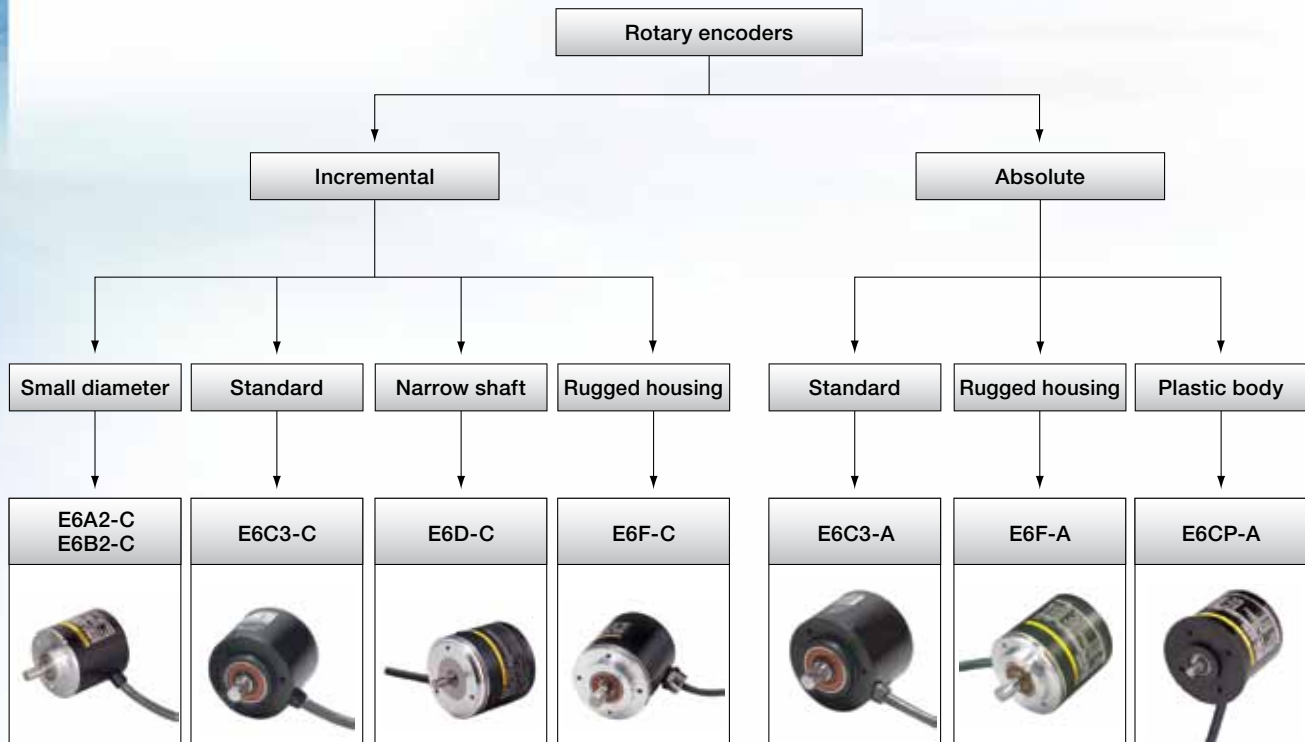
- Wide resolution variety
- Models with rugged housing
- Models for multi-turn applications



Output		Incremental				
						
Model		<b>E6A2-C</b>	<b>E6B2-C</b>	<b>E6D-C</b>	<b>E6C3-C</b>	<b>E6F-C</b>
Type		Small diameter shaft	Small diameter shaft	Small diameter shaft	Standard	Rugged housing
Resolution range (Pulse/rev)	Min	10	10	10	100	100
	Max	500	2,000	6,000	3,600	1,000
Output	NPN	■	■	■	■	■
	PNP	—	■	—	—	—
Size dia. (mm)		25	40	55	50	60
Max. force	Radial	10 N	30 N	50 N	80 N	120 N
	Axial	5 N	20 N	30 N	50 N	50 N
IP rating	IP50	■	■	■	—	—
	IP64	—	—	—	—	—
	IP65	—	—	—	■	■
Max. rotation frequency (rpm)		5,000	6,000	12,000	5,000	5,000

Output		Absolute		
				
Model		<b>E6C3-A</b>	<b>E6F-A</b>	<b>E6CP-A</b>
Type		Standard	Rugged housing	Lightweight, plastic body
Resolution range (Pulse/rev)	Min	6	256	10
	Max	1,024	1,024	256
Output	NPN	■	■	■
	PNP	■	■	—
Size dia. (mm)		50	60	50
Max. force	Radial	80 N	120 N	30 N
	Axial	50 N	50 N	20 N
IP rating	IP50	—	—	■
	IP64	—	—	—
	IP65	■	■	—
Max. rotation frequency (rpm)		5,000	5,000	1,000

■ Standard    □ Available    — No/not available





# NJ Series

## NJ501/301 Machine Automation Controller



### Complete and robust machine Automation

The NJ-Series is designed to meet extreme machine control requirements in terms of motion control speed and accuracy, communication, security and robustness.

NJ can perform independent, coordinated (linear, circular, helical\*) and synchronized (gear/camming) simple and advanced motion control. (\*available soon)

Integrated development environment to develop, commission, tune, debug, trace, and simulate.

Integrated graphical cam design and 2D and 3D simulation.

- 4, 8, 16, 32 and 64 axes motion control
- EtherCAT and EtherNet/IP networks built-in

**SYSTMAC**  
always in control



EtherCAT

- Standard IEC 61131-3 programming.
- Certified PLCopen Function Blocks for Motion Control with parts 1,2,4

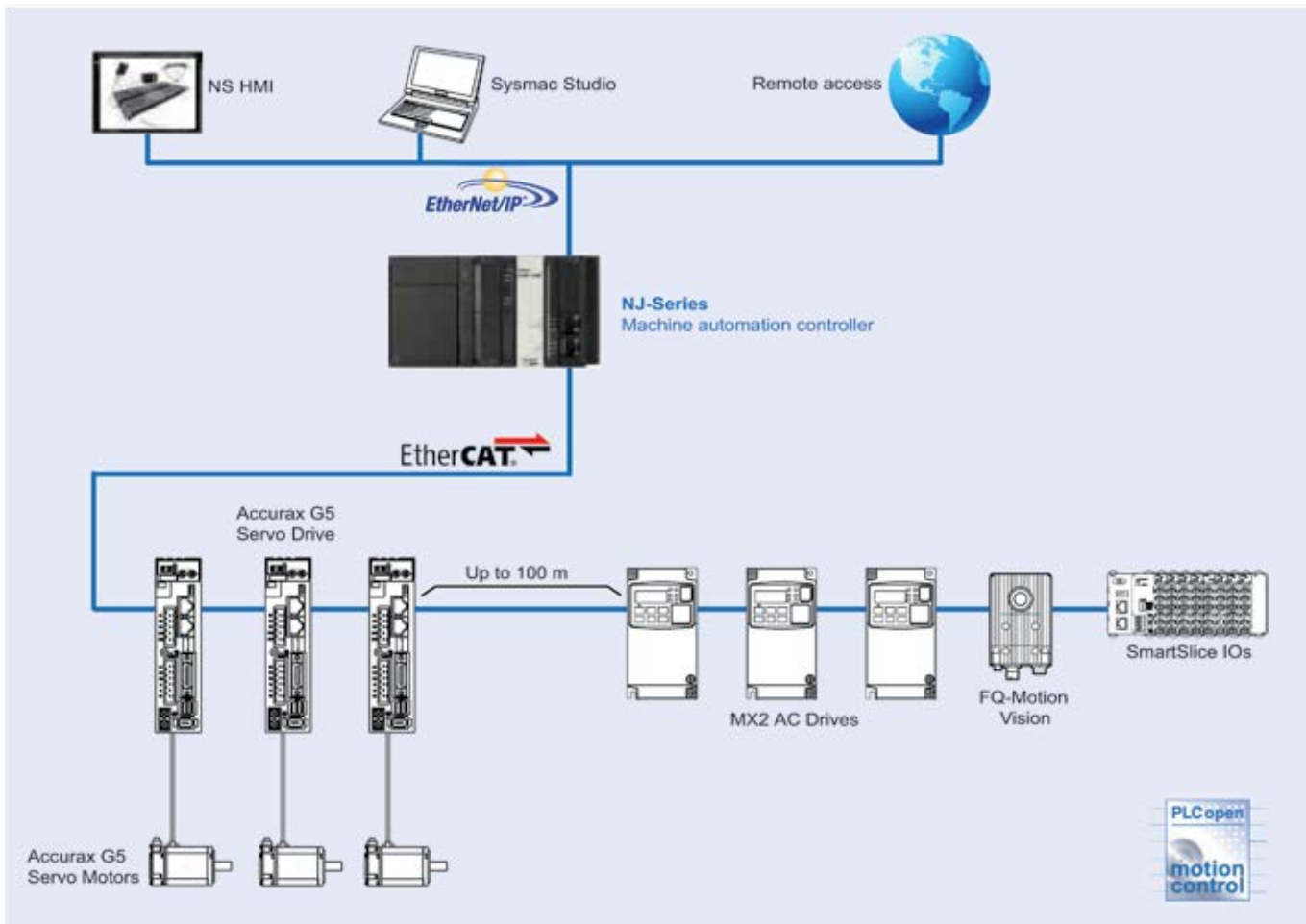

Note: See Section A for Sysmac Controller and system selection guide.

# Trajexia Motion Controller

## TJ1-MC04/16, TJ2-MC04/64



### Stand-alone advanced motion controller uses fast, robust EtherCAT motion bus

- EtherCAT or MECHATROLINK-II motion bus
- Control up to 64 axes of servos and inverters, plus I/Os, over a single motion network
- Supports position, speed and torque control
- Perform advanced motion control via simple motion commands for CAM control, registration control, interpolation and axes synchronization
- Advanced debugging tools including data trace and oscilloscope functions



- Multi-tasking controller capable of running up to 22 tasks simultaneously
- Open communications: Built-in serial and Ethernet
- Optional modules: Profibus-DP, DeviceNet and CANopen

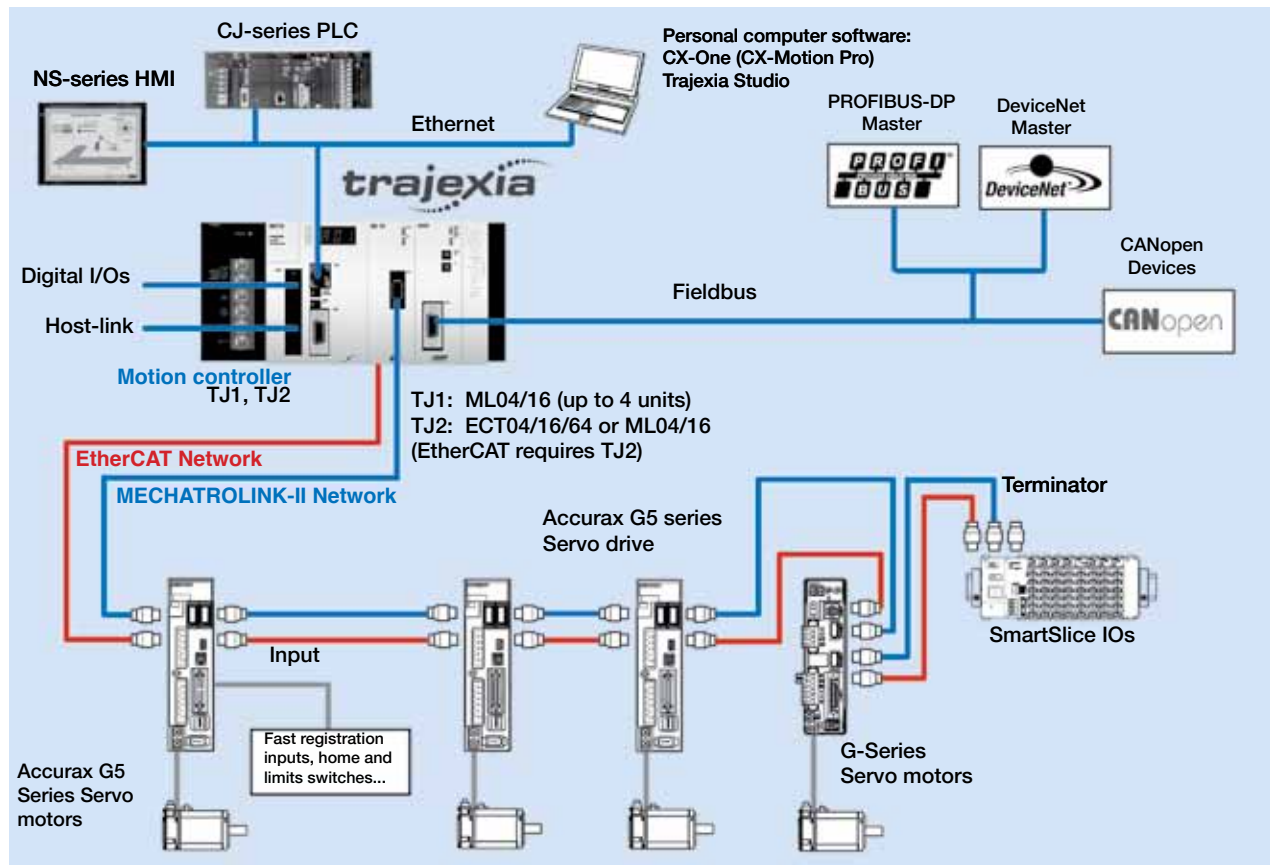

Note: Controller does not allow user to add ESI files. Only EtherCAT listed in CX-Motion Pro or Trajexia Studio can be used.

# Motion Control Unit

## CJ1W-MCH72/MC472



### Advanced multi-axis, PLC-based motion controller uses fast MECHATROLINK-II motion bus

- Control of 4 or up to 30 physical axes
- Selectable cycle time from 0.5 ms to 4 ms
- Control of servos and inverters over a single motion network
- Supports position, speed and torque control
- Advanced motion control such as CAM control, registration control, interpolation and axes synchronization via simple motion commands
- Serial port for external encoder
- Embedded digital I/Os
- I/O data exchange with the PLC CPU
- Installs on compact, high-speed CJ2 and CJ1 PLCs

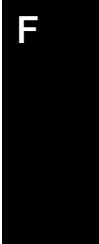
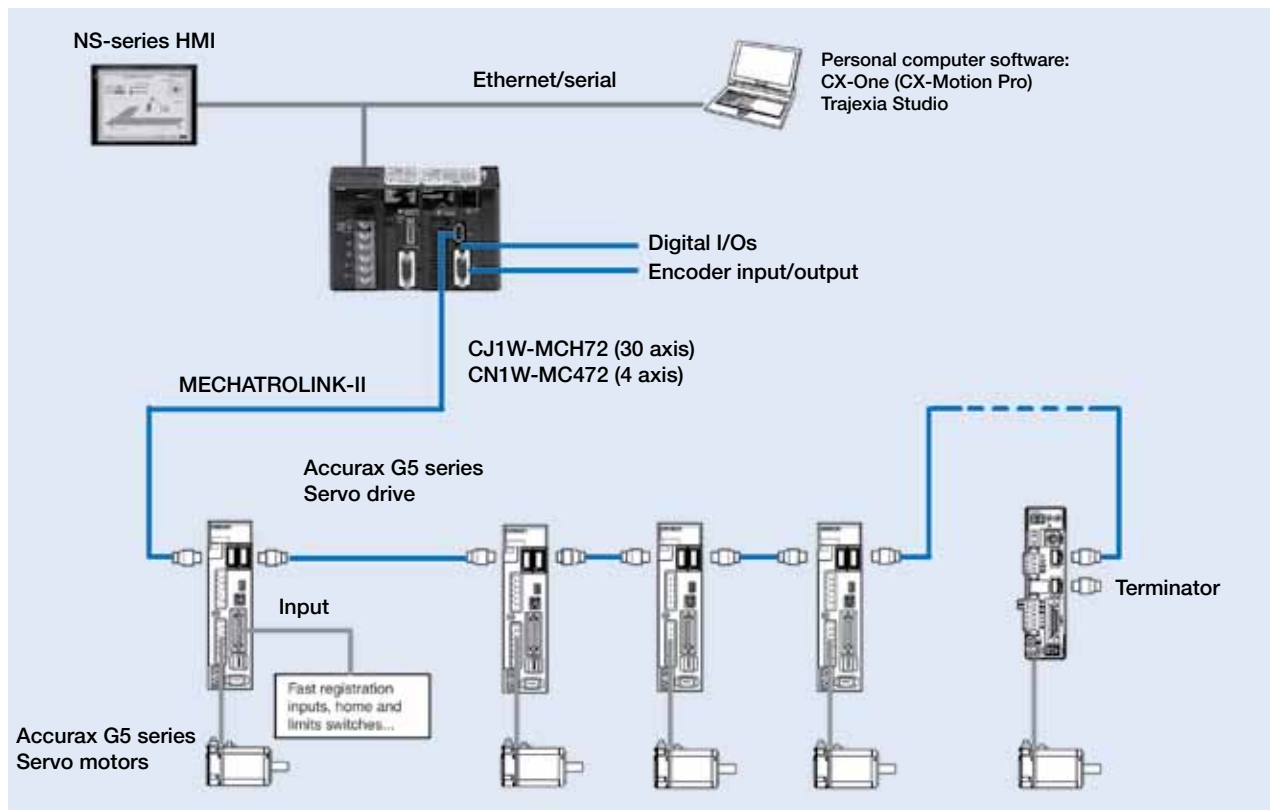

# Position Control Units

CJ1W-NC□81/□82 - EtherCAT Interface

Quick Link

F434

## Preeminent control performance and easy operation feature of EtherCAT improve the production efficiency

The EtherCAT communications with 100Mbps baud rate enables fast and accurate position control for 2, 4, 8 or 16 axes. A wide range of position control functions are available with this position control unit CJ2 PLCs.

- Fast positioning operation: taking from 0.15 to 0.4ms (min.) to start servo operation from PLC start command
- Support for Servomotors with Absolute Encoders
- Monitor the Deviation between Axes during Linear Interpolation
- A Wide Range of Positioning Operations
- Comes with Memory Operation function
- Common control interface with pulse-train type position control unit (CJ1W-NC□□4)
- Fast communication of EtherCAT (250µs min. communications cycle)
- Complete automation: servo, inverters, vision and I/O devices using EtherCAT
- Support for Servomotors Speed Control and Torque limit outputs

EtherCAT®



Used to set and monitor data.

- Editing parameters and data
- Monitoring status
- Data tracing
- Managing files Etc.

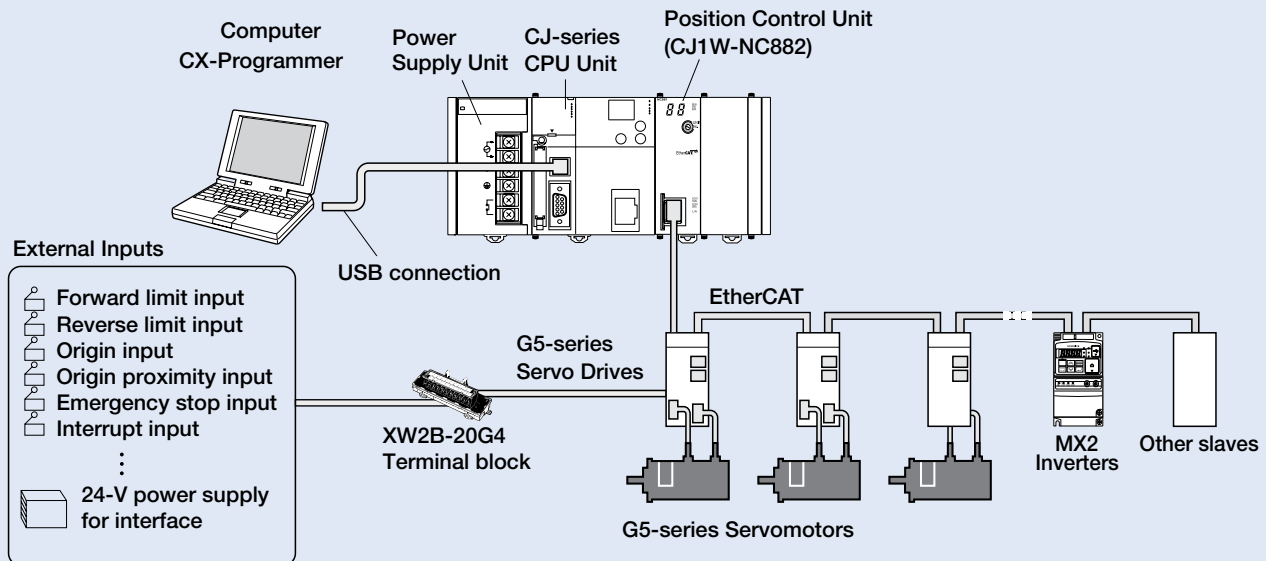

**Note:** The controller does not allow user to add ESI files. Only EtherCAT listed in CX-Programmer can be used.

EtherCAT® is a registered trademark of Beckhoff Automation GmbH.

# Position Control Unit

## CJ1W-NC271/471/F71 - MECHATROLINK-II

Quick Link  
F426

### Multi-axis point-to-point positioning controller over MECHATROLINK-II Motion Bus

- Position control units with 2, 4 or 16 axes
- High-speed bus MECHATROLINK-II is specially designed for motion control
- Supports position, speed and torque control
- Programming languages: ladder, function blocks. Supports PLC Open Function Blocks
- Smart active parts for OMRON HMIs terminals reduce engineering time
- Access to the complete system from one point. Network setup, servo drives configuring and monitoring, and PLC programming
- Installs on compact, high-speed CJ2 and CJ1 PLCs

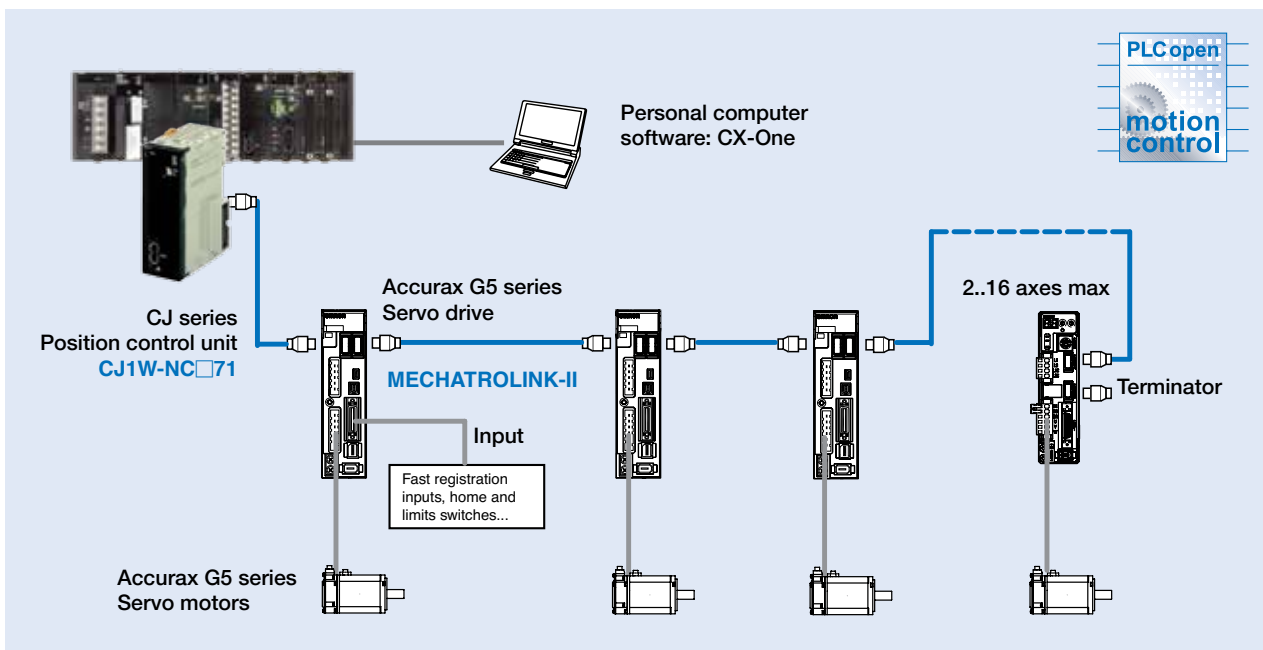

F

# Motion Control Unit

## CS1/C200HW-MC402-E

Quick Link  
F427

### Advanced multi-axes motion control made perfectly intuitive

- Advanced motion control of 4 real axes and 4 virtual axes per unit. Up to 16 modules can be installed in one PLC
- Analogue outputs for CS1-series close loop position and speed control
- Simple to develop and modify using BASIC
- Multi-task programming
- Friendly Motion Perfect, Windows-based programming and debugging software. Provides versatile test and monitoring functions including a 4-channel software oscilloscope
- Hardware registration input for every axis
- Electronic CAM profiles and axes synchronization



### Function

The advanced motion control unit provides closed-loop control of up to 4 axes, it is programmed in a multi-task BASIC type language and supported by the powerful software tool. The unit provides a complete command set, allowing applications such as flying saws, rotating knives, any synchronization and electronic CAM profile to be easily programmed.

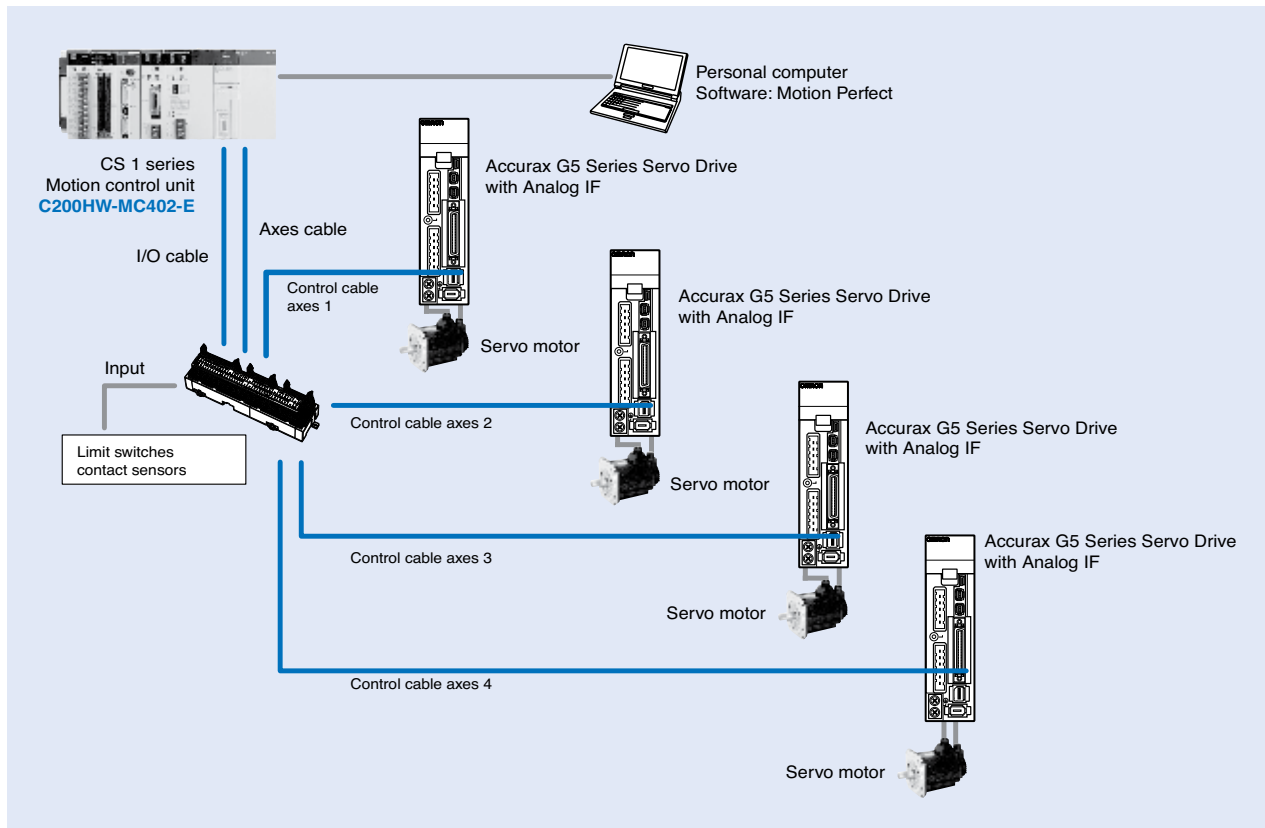

### High-precision, motion controller with multi-tasking G-language programming

- High-speed control of up to 4 axes with one unit and up to 76 axes with one PLC (19 units x 4 axes) (assumes that power supply unit capacity is not exceeded)
- Winding operations easily controlled at high-speed using traverse positioning control
- High-speed response to commands from CPU unit (8 ms for 2 axes, 13 ms for 4 axes)
- Encoder response of 2M PPS possible with 4x frequency multiplication for applications with high-speed, high-precision servo motors
- D interrupt code outputs to CPU unit at end of positioning or at specified positions (D code output time: 3.3 ms max)



- CX-Motion Windows-based support software define user mnemonics to use in place of G codes to simplify MC program development and analysis
- Servo trace function from CX-Motion to trace error counter changes or motor speeds
- Automatic loading function. MC programs and positioning data can be automatically downloaded from computer memory when required by the MC unit

### Function

The motion controller provides closed-loop motion control via analog outputs for up to 4 axes, and supports the G language for advanced, high-speed, high-precision position control. Multi-tasking allows you to run the axes independently for a wider range of application.

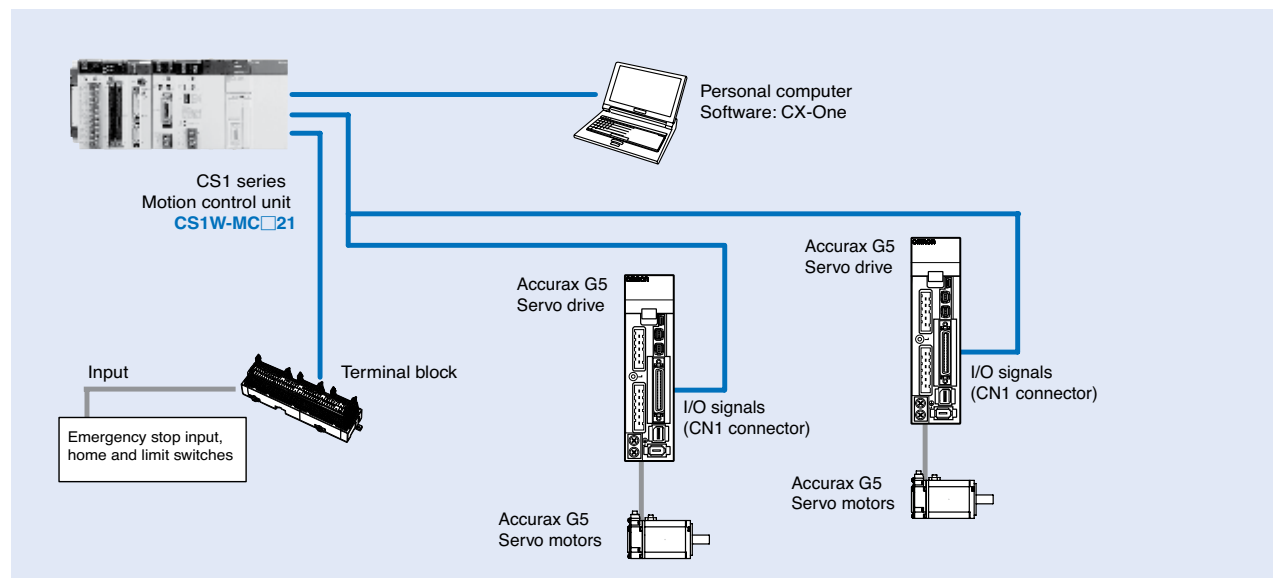

F

# Position Control Units

## CJ1W-NC□□3

Quick Link  
F429

### Advanced multi-axis position control made perfectly intuitive

- Position control units with 1, 2 or 4 axes
  - Positioning can be done by direct ladder commands
  - Position and speed control to CJ-series PLCs
  - Linear interpolation
  - Interrupt feeding function
  - Positioning of 100 points done from memory
  - S-curve acceleration/deceleration, origin search, backlash compensation, and other features are also supported
  - Positioning data is saved in internal flash memory, eliminating the need to maintain a backup battery
- Use Windows-based support software (CX-Position) to easily create positioning data and store data and parameters in files



### Function

These position control units support positioning control via pulse-train outputs. Positioning is performed using trapezoidal or S-curve acceleration and deceleration. Models are available with 1, 2 or 4 axes control, and can be used in combination with servo drives or stepping motors what accept pulse-train control.

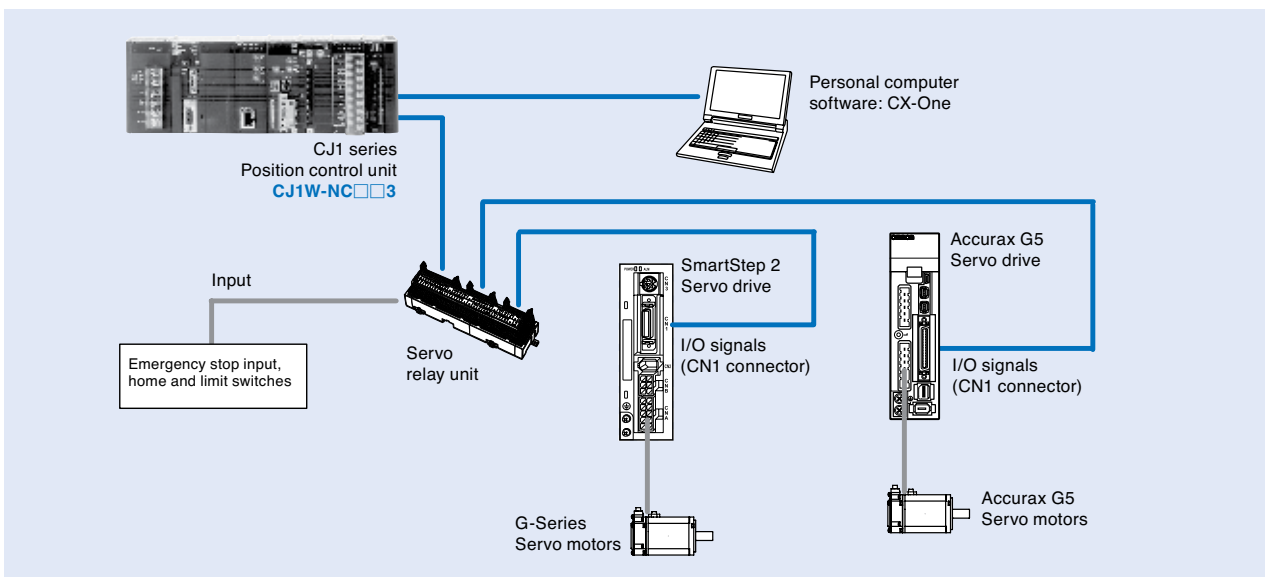



# Position Control Units

CS1W-NC□□3, C200HW-NC□□

Quick Link

F433

## Point-to-point positioning controller with pulse train output

- Position control units with 1, 2 or 4 axes
- Positioning can be done by direct ladder commands
- Position and speed control
- Linear interpolation
- Interrupt feeding function
- Positioning of 100 points done from memory
- S-curve acceleration/deceleration, origin search, backlash compensation, and other features are also supported
- Positioning data is saved in internal flash memory, eliminating the need to maintain a backup battery



- Use Windows-based support software (CX-Position) to easily create positioning data and store data and parameters in files

## Function

These position control units support positioning control via pulse-train outputs. Positioning is performed using trapezoidal or S-curve acceleration and deceleration. Models are available with 1, 2 or 4 axes control, and can be used in combination with servo drives or stepping motors that accept pulse-train control.

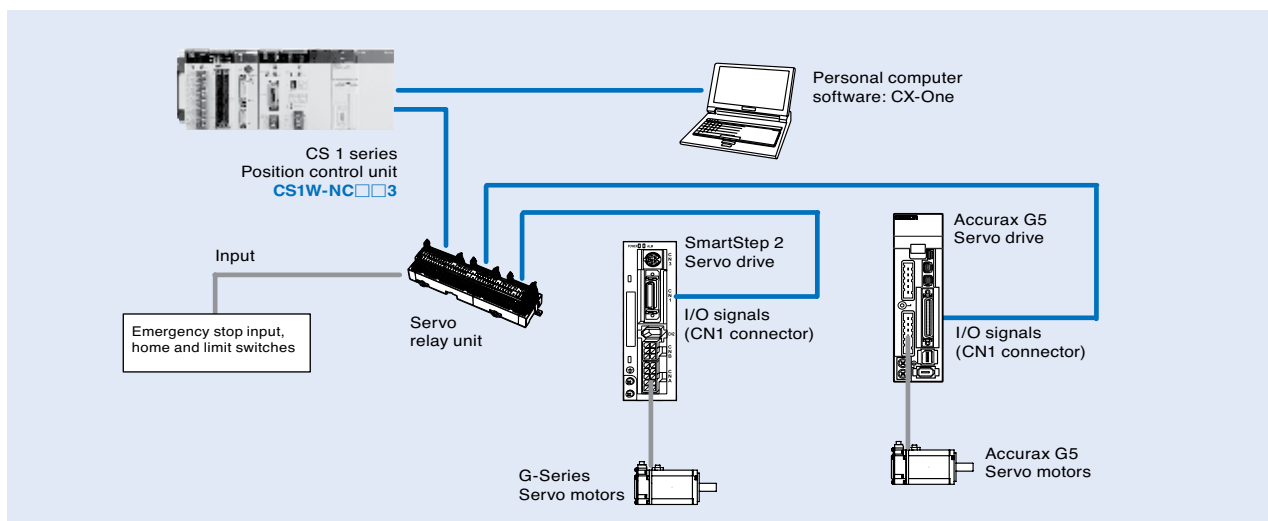

F

## Easy-to-use Stand-alone Cam Positioner Uses Encoder Input

- High-speed operation at 1600 r/min. and high precision settings to 0.5°
- Advanced angle compensation function compensates for output delays
- Highly visible display with reverse-lit LCD for long-distance legibility
- Fits a 1/4 DIN panel cutout
- Front panel and surface/DIN rail mounting models (track mounting adapter optional)
- 8, 16 and 32 outputs models
- Bank function for multi-product production (8 banks)
- IP40 front panel rating; waterproof and protective covers available



Use Omron absolute encoders for cam input; available with easy-to-install connector

- E6CP-AG5C-C 256 2M for 256 pulse/rev resolution
- E6C3-AG5C-C 360 2M for 360 pulse/rev resolution
- E6F-AG5C-C 720 2M for 720 pulse/rev resolution

## Specifications

- Supply voltage: 24 VDC
- Inputs: Encoder input: Connection to a dedicated absolute encoder
- External inputs: bank inputs 1/2/4, origin input, start input (16-/32-output models)
- Control output:
- 8-output Models: 8 cam outputs, 1 RUN output, 1 pulse output
- Dimensions: 96 H x 96 W x 65 D mm
- 16-output Models: 16 cam outputs, 1 RUN output, 1 pulse output
- 32-output Models: 32 cam outputs, 1 RUN output, 1 pulse output

### Output ratings:

- Cam outputs, RUN output: NPN or PNP open collector, 100 mA at 30 VDC
- Pulse outputs: NPN or PNP open collector, 30 mA at 30 VDC

Number of outputs	Mounting method	Dimensions L x W x H mm	Output type	Bank function	Model
8 outputs	Panel mounting	96 x 96 x 67.5	NPN open collector	None	H8PS-8B
			PNP open collector		H8PS-8BP
	DIN rail or surface mounting	96 x 96 x 60.6	NPN open collector		H8PS-8BF
			PNP open collector		H8PS-8BFP
16 outputs	Panel mounting	96 x 96 x 67.5	NPN open collector	None	H8PS-16B
			PNP open collector		H8PS-16BP
	DIN rail or surface mounting	96 x 96 x 60.6	NPN open collector		H8PS-16BF
			PNP open collector		H8PS-16BFP
32 outputs	Panel mounting	96 x 96 x 67.5	NPN open collector	None	H8PS-32B
			PNP open collector		H8PS-32BP
	DIN rail or surface mounting	96 x 96 x 60.6	NPN open collector		H8PS-32BF
			PNP open collector		H8PS-32BFP

### Water Resistant Encoder for Tough Environments

- IP65 drip-proof, oil-proof construction with sealed bearing
- 8 mm stainless steel shaft provides superior shaft loading performance: Radial: 8 kg-f; Axial: 5.1 kg-f
- NPN, or PNP open collector or voltage outputs
- Optimum angle control when combined with cam positioner (stand-alone H8PS or PLC-based) or encoder-input PLC position control modules
- Response frequency: 20 kHz max., 5,000 rpm max
- Pre-wired with 1 meter cable; 2 meter cable available, connector version available for direct connection to an H8PS Cam Positioning Unit



### Absolute Rotary Encoders

When ordering, specify the resolution in addition to the model number (example: E6C3-AG5C 360P/R 1M).

Size	Shaft	Supply Voltage	Output configuration	Output code	Resolution (pulses/rotation)	Connection method	Model
50 dia. x 43 D mm	8 dia. x 15 L mm, stainless steel	12 to 24 VDC	NPN open-collector output	Gray	256, 360, 720	2 m connector for H8PS Cam Positioner	E6C3-AG5C-C
					256, 360, 720, 1,024	Pre-wired, 1 m cable	E6C3-AG5C
				Binary	32, 40		E6C3-AN5C
				BCD	6, 8, 12		E6C3-AB5C
				PNP open-collector output	Gray	256, 360, 720, 1,024	E6C3-AG5B
					Binary	32, 40	E6C3-AN5B
		BCD	6, 8, 12		E6C3-AB5B		
		5 VDC	Voltage output	Binary	256	E6C3-AN1E	
		12 VDC				E6C3-AN2E	

F

## Low-Cost Absolute Encoder, 50 mm Diameter

- High-precision detection of automatic machine timing, also ideal for robot limit signals
- Absolute encoder performance at the cost of an incremental encoder
- Gray code output eliminates reading mistakes
- Lightweight, plastic body construction, IP50 enclosure rating
- Shaft loading: Radial: 3 kg-f; Axial: 2 kg-f
- Open collector output
- Response frequency: 5 kHz max., 1,000 rpm max
- Pre-wired with 2-meter cable, connector version available for direct connection to an H8PS Cam Positioning unit



## Absolute Rotary Encoders

Size	Shaft	Power supply voltage	Output configuration	Output code	Resolution (pulses/rotation)	Connection method	Model
50 dia. x 55 D mm	6 dia. x 10 L mm	5 to 12 VDC	Open-collector output	Gray	256 (8-bit)	Pre-wired, 2 m cable	E6CP-AG3C
		12 to 24 VDC					E6CP-AG5C
						2 m cable with connector for H8PS Cam Positioner	E6CP-AG5C-C

## Rugged Encoder for High-Precision Detection

- 10 mm stainless steel shaft and rugged construction provide the highest shaft loading among Omron encoders: Radial: 12 kg-f, Thrust: 5 kg-f
- IP65f water and oil-proof construction
- High response speed for faster control: Gray code: 20 kHz; BCD: 10 kHz, 5,000 rpm max
- Combine with H8PS Cam Positioner or PLC encoder input module for optimum angle control
- Pre-wired with 2-meter cable, connector version available for direct connection to an H8PS Cam Positioning unit



## Absolute Rotary Encoders

When ordering, specify the resolution in addition to the model number (example: E6C3-AG5C 360P/R 1M).

Size	Shaft	Power supply voltage	Output configuration	Output code	Resolution (pulses/rotation)	Connection method	Model
60 mm dia. x 65 D mm	10 dia. x 20 L mm	5 to 12 VDC	NPN open collector	BCD	360	Pre-wired 2 m cable	E6F-AB3C
			PNP open collector				E6F-AB5B
		12 to 24 VDC	NPN open collector	Gray code	256, 360, 720	2 m cable with connector for H8PS Cam Positioner	E6F-AG5C-C
			PNP open collector				E6F-AG5B
			NPN open collector	Gray code	256, 360, 720, 1,024	Pre-wired 2 m cable	E6F-AG5C
			PNP open collector				E6F-AG5B

### Rugged Encoder for High-Precision Detection

- High response frequency and noise immunity make encoders ideal for factory automation applications with 10 to 500 pulses/revolution
- Space saving enclosure: 25 mm dia.
- 4 mm shaft with load rating of: Radial: 1 kg-f; Axial: 0.5 kg-f
- Open collector output, other output types available
- Output phases: A/A, B and A, B, Z (reversible) are available
- Response frequency: 20 kHz max., 5,000 rpm max
- Enclosure rating: IP50
- Pre-wired with 0.5 meter cable



### Incremental Rotary Encoders

Size	Shaft	Supply voltage	Output configuration	Resolution (pulses/revolution)	Model
25 dia. x 31 D mm	4 dia. x 10 L mm	12 to 24 VDC	NPN open collector, 30 mA max	100	E6A2-CW5C 100P/R 05M
				200	E6A2-CW5C 200P/R 05M

# E6B2-C

## Rotary Encoders—Incremental

Quick Link

F526

### General-Purpose Compact Encoders

- High resolution models (up to 2000 pulses per revolution available) substantially improve measuring accuracy
- Rugged construction: 6 mm shaft with load rating of: Radial: 3 kg-f; Axial: 2 kg-f
- Output phases: A, B, Z (reversible)
- Response frequency: up to 100 kHz max., 6,000 rpm max
- Protected against short-circuit and reversed connections for highly reliable operation
- Available with NPN and PNP open collector, voltage and line driver outputs



- Enclosure rating: IP50
- Pre-wired with 0.5- or 2-meter cables

### Incremental Rotary Encoders

Size	Shaft	Supply voltage	Output configuration	Resolution (pulse/revolution)	Cable length	Model
40 mm dia. x 44 D mm	6 dia. x 15 L mm	12 to 24 VDC	NPN open collector, 35 mA max	100	2 m	E6B2-CWZ6C 100P/R 2M
				200		E6B2-CWZ6C 200P/R 2M
				360	0.5 m	E6B2-CWZ6C 360P/R 05M
				360	2 m	E6B2-CWZ6C 360P/R 2M
				500		E6B2-CWZ6C 500P/R 2M
				600		E6B2-CWZ6C 600P/R 2M
				1000	0.5 m	E6B2-CWZ6C 1000P/R 05M
					2 m	E6B2-CWZ6C 1000P/R 2M
				5 VDC	Line driver: High: -20 mA or 2.5 V min Low: +20 mA or 0.5 V max	0.5 m

F

### Water Resistant Incremental Encoder for Tough Environments

- High resolution solutions from 100 to 3600 pulses/revolution
- IP65f drip-proof, oil-proof construction with sealed bearing
- 8 mm stainless steel shaft provides a load rating of: Radial: 88 kg-f; Axial: 5 kg-f
- Complementary outputs simplify interfacing to NPN or PNP input devices
- Output phases: A, B and Z (reversible)
- Response frequency: 125 kHz max. (65 kHz for Z-phase), 5,000 rpm max
- Surge protection built-in
- Voltage and line driver output versions available
- Pre-wired with 1 meter cable, 2 meter cable is available

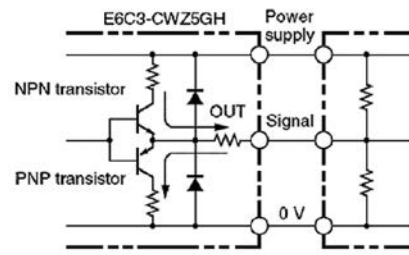

### Incremental Encoders – Complementary NPN and PNP Outputs

Size	Shaft	Supply Voltage	Output configuration	Resolution (pulse/revolution)	Model
50 dia. x 43 D mm	8 dia. x 15 L mm, stainless steel	12 to 24 VDC	Complementary output (NPN and PNP), 35 mA max. 	100	E6C3-CWZ5GH 100P/R 1M
				200	E6C3-CWZ5GH 200P/R 1M
				360	E6C3-CWZ5GH 360P/R 1M
				500	E6C3-CWZ5GH 500P/R 1M
				720	E6C3-CWZ5GH 720P/R 1M
				800	E6C3-CWZ5GH 800P/R 1M
				1000	E6C3-CWZ5GH 1000P/R 1M
				2048	E6C3-CWZ5GH 2048P/R 1M
				2500	E6C3-CWZ5GH 2500P/R 1M
				3600	E6C3-CWZ5GH 3600P/R 1M



# E6D-C Rotary Encoders—Incremental

Quick Link  
F528

## Rugged, High-Resolution Encoder

- Resolution as high as 6,000 pulses/revolution in a rugged construction
- Outputs: A, B (reversible) and Z (zero)
- 55 mm diameter housing
- Superb reliability and accuracy: phase error as small as  $1/4T \pm 0.07T$
- High response frequency of 200 kHz, 12,000 rpm max
- 6 mm shaft with load rating of: Radial: 5 kg-f; Axial: 3 kg-f



## Incremental Rotary Encoders

Size	Shaft	Supply voltage	Output configuration	Resolution (pulses/revolution)	Cable length	Model
44 mm dia. x 44 D mm	6 dia. x 15 L mm	12 VDC	NPN open collector, 35 mA max	720, 800, 1000, 1024, 1200, 1500, 1800, 2000, 2048, 2500, 3000, 3200, 3600, 4096, 5000, 6000	0.5 m	E6D-CWZ2C□□□□P/R 05M
		5 VDC				E6D-CWZ1E□□□□P/R 05M

# E6F-C Rotary Encoders—Incremental

Quick Link  
F529

## Rugged, High-Resolution Encoder

- 10 mm stainless steel shaft and rugged construction provides the highest shaft loading among Omron encoders; Radial: 12 kg-f, Thrust: 5 kg-f
- IP65f water and oil-proof construction
- 60 mm diameter housing
- Complementary output for longer cable length extension
- High response frequency of 83 kHz, 5,000 rpm max



- Output load short-circuit protection to reduce risks from incorrect wiring
- Pre-wired 2 m cable

## Incremental Rotary Encoders

Size	Shaft	Supply voltage	Output configuration	Resolution (pulses/revolution)	Cable length	Model
60 mm dia. x 65 D mm	10 dia. x 20 L mm	12 to 24 VDC	Complementary NPN and PNP, $\pm 30$ mA	100, 200, 360, 500, 600, 1000	2 m	E6F-CWZ5GP/R 2M

F

## Contents

<b>Selection Guide</b>		G-ii
<b>Single-Loop Controllers</b>		
<b>E5CC</b>	Temperature & Process Controllers, 1/16 DIN	G-1
<b>E5CN</b>	Digital temperature controllers, 1/16 DIN	G-2
<b>E5CN-L</b>	Process controllers with 3-color display, 1/16 DIN	G-3
<b>E5CN-U</b>	Plug-in temperature controllers, 1/16 DIN	G-4
<b>E5CN-H</b>	High-performance digital temperature and process controllers, 1/16 DIN	G-5
<b>E5CN-HT</b>	Ramp/soak temperature and process controllers, 1/16 DIN	G-6
<b>E5AN/ E5EN</b>	Digital temperature and process controllers, 1/4 and 1/8 DIN	G-7
<b>E5AN-H/ E5EN-H</b>	High-performance digital temperature and process controllers, 1/4 and 1/8 DIN	G-8
<b>E5AN-HT/ E5EN-HT</b>	Ramp/soak temperature and process controllers, 1/4 and 1/8 DIN	G-9
<b>E5GN</b>	Ultra compact temperature controller, 1/32 DIN	G-10
<b>E5CSV</b>	Simple-to-use digital temperature controller, 1/16 DIN	G-11
<b>E5C2</b>	Analog set temperature controllers, 1/16 DIN	G-12
<b>K8AB-TH</b>	Temperature monitoring relays, protection against over-temperature	G-13

## Multi-Loop Controllers

<b>EJ1</b>	Multi-zone temperature & process controller, up to 256 zones, DIN track mount	G-14
<b>G3ZA</b>	Power controller for SSRs with direct interface for EJ1 temperature controllers	G-15
<b>E5ZN</b>	Modular multi-zone temperature controller, DIN track mount	G-16
<b>E5AR/ E5ER</b>	Multi-zone process controller, 1/4 and 1/8 DIN size, panel mount	G-17

## E5CC & E5EC – HIGH PERFORMANCE WITH SIMPLICITY

### E5CC & E5EC - Temperature Controller

Sets new global standards in the crucial areas of precision, user friendliness and control performance.

- High-contrast, white LCD display visible from large distances and from any angle
- Easy to set up without power supply and operate intuitively via CX-Thermo software
- 50 ms sampling period

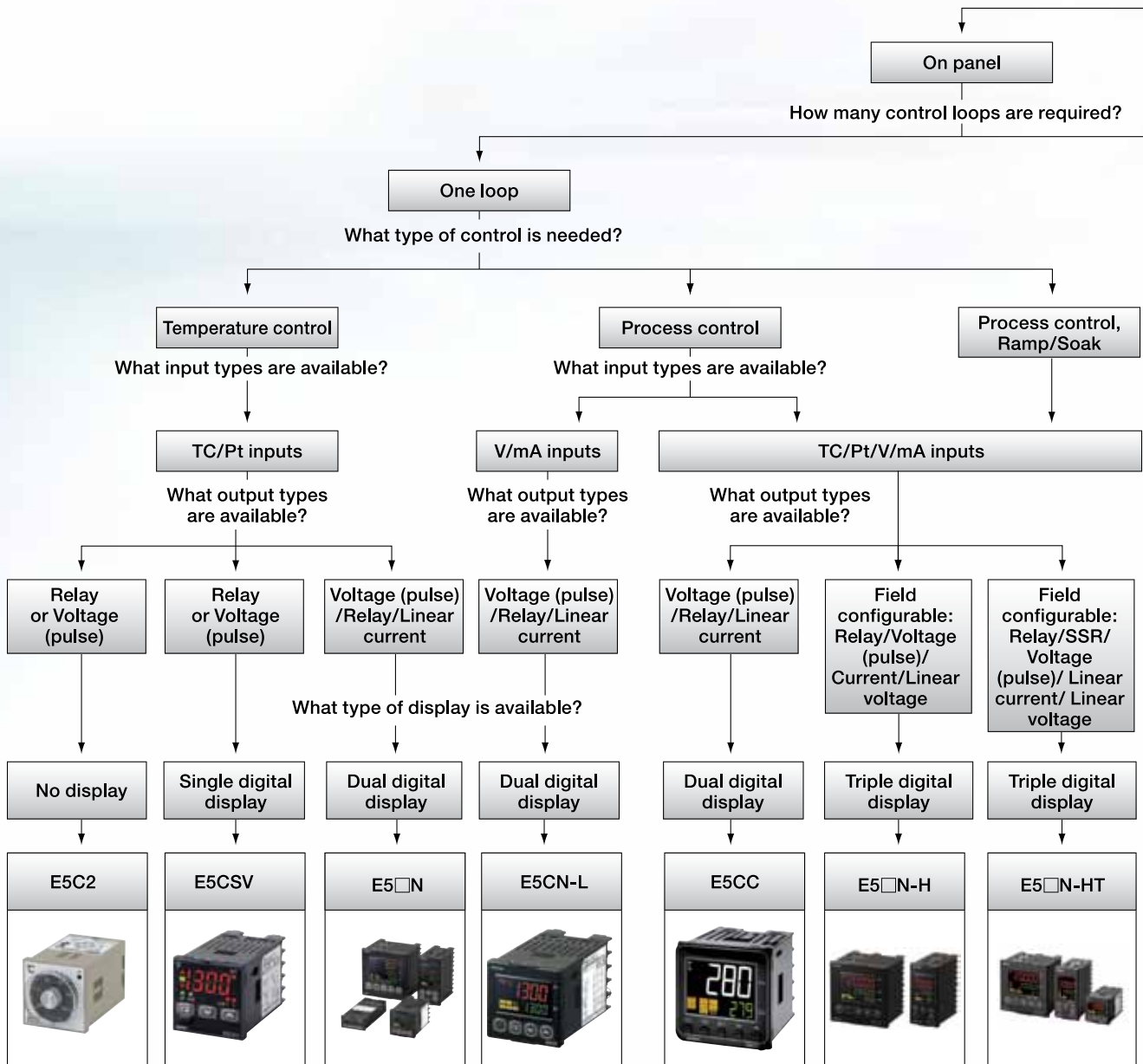



Where will you mount the controller?

In panel

How many control loops are required?

Multi-loop

What type of control is needed?

Advanced Temp/  
Process control

What input types are available?

TC/Pt/V/mA inputs

What output types  
are available?

Field configurable:  
Relay/Voltage  
(pulse)/Linear current

What type of display is available?

Dual digital  
display

E5□R



One loop

What type of control is needed?

Temperature  
monitor

What input types are available?

TC/Pt inputs

What output types  
are available?

Relay

What type of display is available?

No display

K8AB-TH



Multi-loop

What type of control is needed?

Temp/Process  
control

What input types are available?

TC/mV or Pt inputs

What output types are available?

Voltage (pulse)/  
Transistor/  
Linear Current

What type of display is available?

Optional  
display

E5ZN



Advanced Temp/  
Process control

What input types are available?

TC/Pt/V/mA inputs

What output types are available?



Voltage (pulse)/  
Current/Transistor

No display

EJ1



# Selection Table

Category		Alarm Controller	Analog Temperature Controller	Compact Digital Temperature Controller
				
		<b>K8AB-TH</b>	<b>E5C2</b>	<b>E5CSV</b>
Selection criteria	Model	K8AB-TH	E5C2	E5CSV
	Type	Basic		
	Panel	In-panel type	In- & on-panel type	On-panel type
	Loops	–	Single loop	Single loop
Control mode	Size	22.5 mm wide	1/16 DIN	1/16 DIN
	ON/OFF	■	■	■
	PID	–	■*1	–
	2-PID*2	–	–	■
Features	Operation	Temperature monitoring	Heating	Heating & Cooling
	Valve control*3	–	–	–
	Accuracy	±2%	±2%	±.5%
	Auto-tuning	–	–	■
	Self-tuning	–	–	■
	Transfer output	–	–	–
	Remote input	–	–	–
	Number of alarms	1	–	Up to 2
	Heater alarm	–	–	–
	IP rating front panel	IP20	IP20	IP66; NEMA 4X
Supply voltage	Display	Rotary switch	SV analog dial	Single 3.5 digit
	110/240 VAC	■	■	■
Comms*5	24 VAC/VDC	□	–	□
	RS-232	–	–	–
	RS-485	–	–	–
	Event IP	■	–	–
	Quick Link Port port*6	–	–	–
	DeviceNet	–	–	–
	Modbus	–	–	–
Control output	Relay	■	■	■
	SSR	–	–	–
	Voltage (pulse)	–	■	■
	Linear voltage	–	–	–
	Linear current	–	–	–
Input type – linear	mA	–	–	–
	mV	–	–	–
	V	–	–	–
	–	–	–	–
Input type – thermocouple	K	■	■	■
	J	■	–	■
	T	■	–	■
	E	■	–	–
	L	–	■	■
	U	–	–	■
	N	–	–	■
	R	■	–	■
	S	■	–	–
	B	■	–	–
	W	–	–	–
	PLII	■	–	–
Input type – RTD	Pt100	■	■	■
	JPt100	–	–	■
	Themistor	–	■	□

■ Standard    □ Available    – No/not available



\*1 P only

\*2 2-PID is Omron's easy to use high performance PID algorithm

\*3 Valve control = relay up and down

\*4 Heater alarm = heater burnout & SSR failure detection



# Temperature Controllers

Category		Digital Temperature Controller		
				
Selection criteria	Model	E5CC	E5AN	E5EN
	Type	General purpose		
	Panel	On-panel type		
	Loops	Single loop		
	Size	1/16 DIN	1/4 DIN	1/8 DIN
Control mode	ON/OFF	<input checked="" type="checkbox"/>	<input checked="" type="checkbox"/>	<input checked="" type="checkbox"/>
	PID	<input type="checkbox"/>	–	–
	2-PID <sup>*2</sup>	<input checked="" type="checkbox"/>	<input checked="" type="checkbox"/>	<input checked="" type="checkbox"/>
	Operation	Heating/Cooling	Heating & Cooling	Heating & Cooling
	Valve control <sup>*3</sup>	–	–	–
Features	Accuracy	+/-0.3%	±.3%	±.3%
	Auto-tuning	<input checked="" type="checkbox"/>	<input checked="" type="checkbox"/>	<input checked="" type="checkbox"/>
	Self-tuning	<input checked="" type="checkbox"/>	<input checked="" type="checkbox"/>	<input checked="" type="checkbox"/>
	Transfer output	<input checked="" type="checkbox"/>	<input type="checkbox"/>	<input type="checkbox"/>
	Remote input	<input checked="" type="checkbox"/>	–	–
	Number of alarms	3	3	3
	Heater alarm	<input checked="" type="checkbox"/>	<input type="checkbox"/> <sup>*4</sup>	<input type="checkbox"/> <sup>*4</sup>
	IP rating front panel	IP66, NEMA 4X	IP66; NEMA 4X	IP66; NEMA 4X
Supply voltage	Display	Dual 4 digit, (PV=White, SP=Green)	Tri 4 digit (color change)	Tri 4 digit (color change)
	110/240 VAC	<input checked="" type="checkbox"/>	<input checked="" type="checkbox"/>	<input checked="" type="checkbox"/>
Comms <sup>*5</sup>	24 VAC/VDC	<input checked="" type="checkbox"/>	<input type="checkbox"/>	<input type="checkbox"/>
	RS-232	<input checked="" type="checkbox"/>	<input type="checkbox"/>	<input type="checkbox"/>
	RS-485	<input checked="" type="checkbox"/>	<input type="checkbox"/>	<input type="checkbox"/>
	Event IP	<input checked="" type="checkbox"/>	<input type="checkbox"/>	<input type="checkbox"/>
	Quick Link Port port <sup>*6</sup>	<input checked="" type="checkbox"/>	<input checked="" type="checkbox"/>	<input checked="" type="checkbox"/>
	DeviceNet	<input checked="" type="checkbox"/>	–	–
	Modbus	<input checked="" type="checkbox"/>	<input checked="" type="checkbox"/>	<input checked="" type="checkbox"/>
Control output	Relay	<input checked="" type="checkbox"/>	<input checked="" type="checkbox"/>	<input checked="" type="checkbox"/>
	SSR	<input checked="" type="checkbox"/>	–	–
	Voltage (pulse)	<input checked="" type="checkbox"/>	<input checked="" type="checkbox"/>	<input checked="" type="checkbox"/>
	Linear voltage	<input checked="" type="checkbox"/>	–	–
	Linear current	<input checked="" type="checkbox"/>	<input checked="" type="checkbox"/>	<input checked="" type="checkbox"/>
Input type – linear	mA	<input checked="" type="checkbox"/>	<input type="checkbox"/>	<input type="checkbox"/>
	mV	<input checked="" type="checkbox"/>	<input checked="" type="checkbox"/>	<input checked="" type="checkbox"/>
	V	<input checked="" type="checkbox"/>	<input type="checkbox"/>	<input type="checkbox"/>
Input type – thermocouple	K	<input checked="" type="checkbox"/>	<input checked="" type="checkbox"/>	<input checked="" type="checkbox"/>
	J	<input checked="" type="checkbox"/>	<input checked="" type="checkbox"/>	<input checked="" type="checkbox"/>
	T	<input checked="" type="checkbox"/>	<input checked="" type="checkbox"/>	<input checked="" type="checkbox"/>
	E	<input checked="" type="checkbox"/>	<input checked="" type="checkbox"/>	<input checked="" type="checkbox"/>
	L	<input checked="" type="checkbox"/>	<input checked="" type="checkbox"/>	<input checked="" type="checkbox"/>
	U	<input checked="" type="checkbox"/>	<input checked="" type="checkbox"/>	<input checked="" type="checkbox"/>
	N	<input checked="" type="checkbox"/>	<input checked="" type="checkbox"/>	<input checked="" type="checkbox"/>
	R	<input checked="" type="checkbox"/>	<input checked="" type="checkbox"/>	<input checked="" type="checkbox"/>
	S	<input checked="" type="checkbox"/>	<input checked="" type="checkbox"/>	<input checked="" type="checkbox"/>
	B	<input checked="" type="checkbox"/>	<input checked="" type="checkbox"/>	<input checked="" type="checkbox"/>
	W	<input checked="" type="checkbox"/>	<input checked="" type="checkbox"/>	<input checked="" type="checkbox"/>
	PLII	<input checked="" type="checkbox"/>	<input checked="" type="checkbox"/>	<input checked="" type="checkbox"/>
	Input type – RTD	Pt100	<input checked="" type="checkbox"/>	<input checked="" type="checkbox"/>
JPt100		<input checked="" type="checkbox"/>	<input checked="" type="checkbox"/>	<input checked="" type="checkbox"/>
Themistor		–	–	–

■ Standard    □ Available    – No/not available

\*5 PROFIBUS-DP communication option via PRT1-SCU11 for E5\_N(-H), E5\_R, E5\_J1  
 \*6 QLP: Quick Link Port to connected TC to PC using the smart USB cable E58-CIFQ1

# Selection Table

Category		Digital Temperature Controllers		
				
Selection criteria	Model	E5CN	E5GN	
	Type	General purpose		
	Panel	On-panel type		
	Loops	Single loop		
Control mode	Size	1/16 DIN	1/32 DIN	
	ON/OFF	<input checked="" type="checkbox"/>	<input checked="" type="checkbox"/>	
	PID	–	–	
	2-PID *2	<input checked="" type="checkbox"/>	<input checked="" type="checkbox"/>	
	Operation	Heating & Cooling	Heating & Cooling	
	Valve control *3	–	–	
	Accuracy	±.3%	±.3%	
Features	Auto-tuning	<input checked="" type="checkbox"/>	<input checked="" type="checkbox"/>	
	Self-tuning	<input checked="" type="checkbox"/>	<input checked="" type="checkbox"/>	
	Transfer output	<input type="checkbox"/>	<input type="checkbox"/>	
	Remote input	–	–	
	Number of alarms	3	2	
	Heater alarm *4	<input type="checkbox"/>	<input type="checkbox"/>	
	IP rating front panel	IP66; NEMA 4X	IP66; NEMA 4X	
	Display	Dual 4 digit (color change)	Dual 4 digit (color change)	
	Supply voltage	110/240 VAC	<input checked="" type="checkbox"/>	<input checked="" type="checkbox"/>
		24 VAC/VDC	<input type="checkbox"/>	<input type="checkbox"/>
Comms*5	RS-232	–	–	
	RS-485	<input type="checkbox"/>	<input type="checkbox"/>	
	Event IP	<input type="checkbox"/>	<input type="checkbox"/>	
	Quick Link Port port*6	<input checked="" type="checkbox"/>	<input checked="" type="checkbox"/>	
	DeviceNet	–	–	
	Modbus	<input checked="" type="checkbox"/>	<input checked="" type="checkbox"/>	
Control output	Relay	<input checked="" type="checkbox"/>	<input checked="" type="checkbox"/>	
	SSR	–	–	
	Voltage (pulse)	<input checked="" type="checkbox"/>	<input checked="" type="checkbox"/>	
	Linear voltage	–	–	
	Linear current	<input checked="" type="checkbox"/>	–	
Input type – linear	mA	<input type="checkbox"/>	<input type="checkbox"/>	
	mV	<input checked="" type="checkbox"/>	<input checked="" type="checkbox"/>	
	V	<input type="checkbox"/>	<input type="checkbox"/>	
Input type – thermocouple	K	<input checked="" type="checkbox"/>	<input checked="" type="checkbox"/>	
	J	<input checked="" type="checkbox"/>	<input checked="" type="checkbox"/>	
	T	<input checked="" type="checkbox"/>	<input checked="" type="checkbox"/>	
	E	<input checked="" type="checkbox"/>	<input checked="" type="checkbox"/>	
	L	<input checked="" type="checkbox"/>	<input checked="" type="checkbox"/>	
	U	<input checked="" type="checkbox"/>	<input checked="" type="checkbox"/>	
	N	<input checked="" type="checkbox"/>	<input checked="" type="checkbox"/>	
	R	<input checked="" type="checkbox"/>	<input checked="" type="checkbox"/>	
	S	<input checked="" type="checkbox"/>	<input checked="" type="checkbox"/>	
	B	<input checked="" type="checkbox"/>	<input checked="" type="checkbox"/>	
	W	<input checked="" type="checkbox"/>	<input checked="" type="checkbox"/>	
	PLII	<input checked="" type="checkbox"/>	<input checked="" type="checkbox"/>	
	Input type – RTD	Pt100	<input checked="" type="checkbox"/>	<input checked="" type="checkbox"/>
JPt100		<input checked="" type="checkbox"/>	<input checked="" type="checkbox"/>	
Themistor		–	–	

■ Standard    □ Available    – No/not available





\*1 P only

\*2 2-PID is Omron's easy to use high performance PID algorithm

\*3 Valve control = relay up and down

\*4 Heater alarm = heater burnout & SSR failure detection

# Temperature Controllers

Category		Digital Temperature Controller		Digital Process Controller	
					
Selection criteria	Model	E5ZN	EJ1	E5CN-H	E5EN-H/AN-H
	Type	Modular		Universal	
	Panel	In-panel type		On-panel type	
	Loops	Multi-loop		Single loop	
	Size	22.5 mm wide	31x96 mm	1/16 DIN	1/4, 1/8 DIN
Control mode	ON/OFF	■	■	■	■
	PID	–	–	–	–
	2-PID <sup>*2</sup>	■	■	■	■
	Operation	Heating and cooling	Heating & Cooling	Heating & Cooling	Heating & Cooling
	Valve control <sup>*3</sup>	–	–	□	□
Features	Accuracy	±0.5%	±0.5%	±0.1%	±0.1%
	Auto-tuning	■	■	■	■
	Self-tuning	–	■	■	■
	Transfer output	■	□	□	□
	Remote input	■	–	–	■
	Number of alarms	2	4	3	3
	Heater alarm	□	□ <sup>*4</sup>	□ <sup>*4</sup>	□ <sup>*4</sup>
	IP rating front panel	–	–	IP66; NEMA 4X	IP66; NEMA 4X
	Display	□	–	Dual 5 digit (color change)	Triple 5 digit (color change)
	Supply voltage	110/240 VAC	–	■	■
	24 VAC/VDC	■	■	□	
Comms <sup>*5</sup>	RS-232	–	■	□	□
	RS-485	■	■	□	□
	Event IP	–	■	□	■
	Quick Link Port port <sup>*6</sup>	–	■	■	■
	DeviceNet	□	□	–	–
	Modbus	–	■	■	■
Control output	Relay	–	–	■	■
	SSR	■	–	–	■
	Voltage (pulse)	–	■	■	■
	Linear voltage	■	–	■	■
	Linear current	■	■	■	■
Input type – linear	mA	–	■	■	■
	mV	0-50	■	■	■
	V	–	■	■	■
Input type – thermocouple	K	■	■	■	■
	J	■	■	■	■
	T	■	■	■	■
	E	■	■	■	■
	L	■	■	■	■
	U	■	■	■	■
	N	■	■	■	■
	R	■	■	■	■
	S	■	■	■	■
	B	■	■	■	■
	W	–	■	■	■
	PLII	–	■	■	■
Input type – RTD	Pt100	■	■	■	■
	JPt100	■	■	■	■
	Thermistor	–	–	–	–



■ Standard    □ Available    – No/not available

\*5 PROFIBUS-DP communication option via PRT1-SCU11 for E5\_N(-H), E5\_R, EJ1

\*6 QLP: Quick Link Port to connected TC to PC using the smart USB cable E58-CIFQ1



# Selection Table

Category					
					
					
Selection criteria	Model	E5□N-HT		E5AR	
	Type	Universal, Ramp/Soak		Advanced	
	Panel	On-panel type		On-panel type	
	Loops	Single loop		Multi-loop	
	Size	1/4, 1/8, 1/16 DIN		1/4 DIN	
Control mode	ON/OFF	<input checked="" type="checkbox"/>		<input checked="" type="checkbox"/>	
	PID	-		-	
	2-PID <sup>*2</sup>	<input checked="" type="checkbox"/>		<input checked="" type="checkbox"/>	
	Operation	Heating & Cooling		Heating & Cooling	
	Valve Control <sup>*3</sup>	<input type="checkbox"/>		<input checked="" type="checkbox"/>	
Features	Accuracy	±0.1%		±0.1%	
	Auto-tuning	<input checked="" type="checkbox"/>		<input checked="" type="checkbox"/>	
	Self-tuning	<input checked="" type="checkbox"/>		-	
	Transfer output	<input type="checkbox"/>		<input checked="" type="checkbox"/>	
	Remote input	<input type="checkbox"/>		<input checked="" type="checkbox"/>	
	Number of alarms	2 or 3		4	
	Heater alarm	<input type="checkbox"/>		-	
	IP rating front panel	IP66; NEMA 4X		IP66; NEMA 4X	
	Display	Dual 4 digit		Triple 5 digit	
Supply voltage	110/240 VAC	<input checked="" type="checkbox"/>		<input checked="" type="checkbox"/>	
	24 VAC/VDC	<input type="checkbox"/>		<input type="checkbox"/>	
Comms <sup>*5</sup>	RS-232	<input type="checkbox"/>		-	
	RS-485	<input type="checkbox"/>		<input type="checkbox"/>	
	Event IP	<input type="checkbox"/>		<input checked="" type="checkbox"/>	
	Quick Link port <sup>*6</sup>	<input checked="" type="checkbox"/>		<input checked="" type="checkbox"/>	
	DeviceNet	-		<input type="checkbox"/>	
	Modbus	<input checked="" type="checkbox"/>		<input checked="" type="checkbox"/>	
Control output	Relay	<input checked="" type="checkbox"/>		<input checked="" type="checkbox"/>	
	SSR	<input checked="" type="checkbox"/>		-	
	Voltage (pulse)	<input checked="" type="checkbox"/>		<input checked="" type="checkbox"/>	
	Linear voltage	<input checked="" type="checkbox"/>		-	
	Linear current	<input checked="" type="checkbox"/>		<input checked="" type="checkbox"/>	
Input type – linear	mA	<input checked="" type="checkbox"/>		<input checked="" type="checkbox"/>	
	mV	-		-	
	V	<input checked="" type="checkbox"/>		<input checked="" type="checkbox"/>	
Input type – thermocouple	K	<input checked="" type="checkbox"/>		<input checked="" type="checkbox"/>	
	J	<input checked="" type="checkbox"/>		<input checked="" type="checkbox"/>	
	T	<input checked="" type="checkbox"/>		<input checked="" type="checkbox"/>	
	E	<input checked="" type="checkbox"/>		<input checked="" type="checkbox"/>	
	L	<input checked="" type="checkbox"/>		<input checked="" type="checkbox"/>	
	U	<input checked="" type="checkbox"/>		<input checked="" type="checkbox"/>	
	N	<input checked="" type="checkbox"/>		<input checked="" type="checkbox"/>	
	R	<input checked="" type="checkbox"/>		<input checked="" type="checkbox"/>	
	S	<input checked="" type="checkbox"/>		<input checked="" type="checkbox"/>	
	B	<input checked="" type="checkbox"/>		<input checked="" type="checkbox"/>	
	W	<input checked="" type="checkbox"/>		<input checked="" type="checkbox"/>	
	PLII	<input checked="" type="checkbox"/>		-	
	Input type – RTD	Pt100	<input checked="" type="checkbox"/>		<input checked="" type="checkbox"/>
JPt100		-		-	
Thermistor		-		-	

■ Standard    □ Available    - No/not available

\*2 2-PID is Omron's easy to use high performance PID algorithm  
 \*3 Valve control = relay up and down

\*5 PROFIBUS-DP communication option via PRT1-SCU11 for E5\_N(-H), E5\_R, EJ1  
 \*6 QLP: Quick Link port to connected TC to PC using the smart USB cable E58-CIFQ1

## 1/16 DIN Size Temperature & Process Controllers with High Visibility Display

- Fast and precise regulation: 50 ms sampling loop period time
- Easy to set up without power supply and operate intuitively via CX-Thermo software v4.4 or higher
- High-contrast, white LED display visible from a far distance and from any angle (PV: 15.2 H mm)
- Useful alarm and diagnostic functions for secure operation
- Compact with short body depth: 48 H x 48 W x 60 D mm



## Specifications

- Universal Inputs:
  - Thermocouple: Types K, J, T, E, L, U, N, R, S, B, W, or PL II
  - Platinum RTD: Pt100 or JPt100
  - Infrared sensor: Infrared temperature sensor: 10°-70°C, 60°-120°C, 115° -165°C, 160°-260°C
  - Current: 4 to 20 mA or 0 to 20 mA
  - Voltage: 1 to 5 V, 0 to 5 V, or 0 to 10

- Accuracy:
  - Thermocouple: ( $\pm 0.3\%$  of indicated value or  $\pm 1^\circ\text{C}$ , whichever is greater)  $\pm 1$  digit max.
  - Platinum RTD: ( $\pm 0.2\%$  of indicated value or  $\pm 0.8^\circ\text{C}$ , whichever is greater)  $\pm 1$  digit max.
  - Analog:  $\pm 0.2\%$  FS  $\pm 1$  digit max.
- Control output:
  - Relay Output: SPST-NO, 250 VAC, 3 A (resistive load)
  - Voltage (pulse) Output: 12 VDC  $\pm 20\%$  (PNP), max. load current: 21 mA, with short-circuit protection circuit
  - Current Output: 4 to 20 mA DC/0 to 20 mA DC, load: 500  $\Omega$  max., resolution: approx. 10,000
- Front Panel Rating: NEMA 4X / IP66

## 1/16 DIN Temperature & Process Controllers

Input	Output	Fixed option	Alarms	Model: AC110-240V	Model: AC/DC24V
Temp. & Analog	Out1: Relay	---	3 relays	E5CC-RX3A5M-000	E5CC-RX3D5M-000
		Event Input 2, Transfer output		E5CC-RX3A5M-006	---
		Event Input 2, Remote SP		E5CC-RX3A5M-007	---
	Out1: Voltage (pulse)	---		E5CC-QX3A5M-000	E5CC-QX3D5M-000
		Event Input 2, Heater Burnout SSR defect detection		E5CC-QX3A5M-001	---
		Communication 3-phase heater alarm		E5CC-QX3A5M-003	---
		Event Input 2, Transfer output		E5CC-QX3A5M-006	---
Temp. & Analog	Out1: Voltage (pulse)	---	E5CC-QQ3A5M-000	---	
		Event Input 2, Heater Burnout SSR defect detection	E5CC-QQ3A5M-001	---	
	Out1: Linear current	---	E5CC-CX3A5M-000	E5CC-CX3D5M-000	
		Event Input 2, Transfer output	E5CC-CX3A5M-006	---	
		Event Input 2, Remote SP	E5CC-CX3A5M-007	---	

## 1/16 DIN Size Temperature Controllers with 3-Color Display

- Fast sampling rate (250 ms)
- Password protected settings limit access
- 3-color display indicates changes in PV status to make monitoring more informative
- Optional software enables fast and easy controller setup and monitoring via PC
- Front Panel Rating: NEMA 4X / IP66



## Specifications

- Temperature Inputs:
  - Thermocouple: Types K, J, T, L, E, U, N, R, S, B, W, or PL II
  - Platinum RTD: Pt100 and JPt100
  - Infrared temperature sensor: 10°-70°C, 60°-120°C, 115° -165°C, 160°-260°C
  - Voltage: 0 to 50 mV
- Accuracy:
  - Thermocouple:  $\pm 0.3\%$  of indicated value or  $\pm 1^\circ\text{C}$  (whichever is greater),  $\pm 1$  digit max.
  - Platinum RTD:  $\pm 0.2\%$  of indicated value or  $\pm 0.8^\circ\text{C}$  (whichever is greater),  $\pm 1$  digit max.
- Relay output: SPST-NO, 3 A at 250 VAC
  - 100,000 electrical operations (standard)
  - 1 million operations (long-life hybrid relay)
- Voltage output: 12 VDC  $\pm 15\%$  for SSR, 21 mA max. load with short-circuit protection
  - Voltage pulse output is for driving an external SSR
- Current output: 4-20 mA DC/0-20 mA DC, load: 600  $\Omega$  max., approx. 10,000 resolution

## Panel Mount, Screw Terminal Temperature Controllers

Supply voltage	Auxiliary outputs	Control outputs	Model (only black models listed)
100-240 VAC, 50/60 Hz	0 (See note)	Relay	E5CN-RMT-500 AC100-240
		Voltage	E5CN-QMT-500 AC100-240
		Current	E5CN-CMT-500 AC100-240
	2 (See note)	Relay	E5CN-R2MT-500 AC100-240
		Voltage	E5CN-Q2MT-500 AC100-240
		Current	E5CN-C2MT-500 AC100-240
		Long-life Relay	E5CN-Y2MT-500 AC100-240
24 VAC, 50/60 Hz, 24 VDC	0	Relay	E5CN-RMTD-500 ACDC24
		Voltage	E5CN-QMTD-500 ACDC24
		Current	E5CN-CMTD-500 ACDC24
	2 (See note)	Relay	E5CN-R2MTD-500 ACDC24
		Voltage	E5CN-Q2MTD-500 ACDC24
		Current	E5CN-C2MTD-500 ACDC24

**Note:** To order these specific models in silver add "W" to the part number (e.g. E5CN-R2MT-W-500 AC100-240); other models listed only available in black.

## 1/16 DIN Size Process Controllers with 3-Color Display

- Sampling rate (250 ms) and short control period (0.5 s minimum) improves response
- Password protected settings limit access
- ON/OFF control or 2-PID with auto-tuning for superior performance
- Optional software enables fast and easy controller setup and monitoring via PC
- Built-in PC communication port reduces costs and simplifies installation
- Modbus communication/high speed 38,400 bps
- Front Panel Rating: NEMA 4X / IP66



## Specifications

- Analog inputs:
  - Current: 4 to 20 mA, 0 to 20 mA
  - Voltage: 1 to 5 V, 0 to 5 V, 0 to 10 V
- Accuracy:  $\pm 0.2\%$  FS  $\pm 1$  digit max.
- Relay output: SPST-NO, 3 A at 250 VAC (SPDT – plug-in models)
  - 100,000 electrical operations (standard)
  - 1 million operations (long-life hybrid relay)
- Voltage output for SSR: 12 VDC  $\pm 15\%$ , 21 mA max. load with short-circuit protection
- Current output: 4-20 mA DC/0-20 mA DC, load: 600  $\Omega$  max., approx. 10,000 resolution

## Panel Mount Process Controllers

Supply voltage	Auxiliary outputs	Control outputs	Model (only black models listed)
100-240 VAC, 50/60 Hz	0	Relay	E5CN-RML-500 AC100-240
		Voltage	E5CN-QML-500 AC100-240
		Current	E5CN-CMT-500 AC100-240
	2	Relay	E5CN-R2MT-500 AC100-240
		Voltage	E5CN-Q2MT-500 AC100-240
		Current	E5CN-C2MT-500 AC100-240
24 VAC, 50/60 Hz, 24 VDC	2	Long-life Relay	E5CN-Y2ML-500 AC100-240
		Relay	E5CN-R2MLD-500 ACDC24
		Voltage	E5CN-Q2MLD-500 ACDC24
		Current	E5CN-C2MLD-500 ACDC24

## 1/16 DIN Size Plug-in Temperature Controllers

Designed for simple installation and fast servicing, E5CN-U models plug into standard 11-pin round sockets.

- Fast sampling rate (250 ms)
- Password protected settings limit access
- 3-color display indicates changes in PV status to make monitoring more informative
- ON/OFF control or 2-PID with auto-tuning for superior performance
- Fits track-mount P2CF-11-E or P3GA-11 back mount sockets



## Specifications

- Temperature Inputs:
  - Thermocouple: Types K, J, T, L, E, U, N, R, S, B, W, or PL II
  - Platinum RTD: Pt100 and JPt100
  - Infrared temperature sensor: 10°-70°C, 60°-120°C, 115° -165°C, 160°-260°C
  - Voltage: 0 to 50 mV
- Relay Output: SPDT, 3 A at 250 VAC
  - 100,000 electrical operations
- Voltage Output for SSR: 12 VDC  $\pm 15\%$ , 21 mA max. load with short-circuit protection
- Accuracy:
  - Thermocouple:  $\pm 0.3\%$  of indicated value or  $\pm 2^\circ\text{C}$  (whichever is greater),  $\pm 1$  digit max.
  - Platinum RTD:  $\pm 0.2\%$  of indicated value or  $\pm 0.8^\circ\text{C}$  (whichever is greater),  $\pm 1$  digit max.

## Plug-in Temperature Controllers

Supply voltage	Auxiliary outputs	Control outputs	Model
100-240 VAC, 50/60 Hz	0	Relay	E5CN-RTU AC100-240
		Voltage	E5CN-QTU AC100-240
	1	Relay	E5CN-R1TU AC100-240
		Voltage	E5CN-Q1TU AC100-240
	2	Relay	E5CN-R2TU AC100-240
		Voltage	E5CN-Q2TU AC100-240
24 VAC, 50/60 Hz, 24 VDC	0	Relay	E5CN-RTDU ACDC24
		Voltage	E5CN-QTDU ACDC24
	1	Relay	E5CN-R1TDU ACDC24
		Voltage	E5CN-Q1TDU ACDC24
	2	Relay	E5CN-R2TDU ACDC24
		Voltage	E5CN-Q2TDU ACDC24

## Advanced, High-Performance 1/16 DIN Size Temperature & Process Controllers

- Easy-to-read, high-resolution, 11-segment display with 5 digits/0.01°C or F
- Achieve high-speed disturbance recovery from 60 ms sampling rate
- Flexible logic operations (AND, OR, and delays) with contact outputs set from CX-Thermo software
- Optional units include event inputs, communications, 1-phase and 3-phase heater burnout, transfer output, and a second control output



## Specifications

- Universal Inputs:
  - Thermocouple: Types K, J, T, L, E, U, N, R, S, B, W, or PL II
  - Platinum RTD input: Pt100 and JPt100
  - Current input: 4-20 mA, 0 to 20 mA
  - Voltage: 1 to 5 V, 0 to 5 V or 0 to 10 V
- Thermocouple: ( $\pm 0.1\%$  of indicated value or  $\pm 1^\circ\text{C}$ , whichever is greater)  $\pm 1$  digit max.
- Platinum RTD: ( $\pm 0.1\%$  of indicated value or  $\pm 0.5^\circ\text{C}$ , whichever is greater)  $\pm 1$  digit max.
- Analog Input:  $\pm 0.1\%$  FS  $\pm 1$  digit max.
- CT input:  $\pm 5\%$  FS  $\pm 1$  digit max.
- Relay Output: SPST-NO, 3 A at 250 VAC
  - 100,000 electrical operations (standard)
- Voltage Output: 12 VDC  $\pm 15\%$  for SSR, 21 mA max. load with short-circuit protection
- Current Output: 4-20 mA DC/0 to 20 mA DC, 600  $\Omega$  max., approx. 10,000 resolution
- Linear Voltage Input: 0 to 10 VDC (load: 1 k $\Omega$  min.), approx. 10,000 resolution

## Panel Mount, Screw Terminal Temperature & Process Controllers

Supply voltage	Auxiliary outputs	Control outputs	Model (only black models listed)
100-240 VAC, 50/60 Hz	2	Relay (See note)	E5CN-HR2M-500 AC100-240
		Voltage (See note)	E5CN-HQ2M -500 AC100-240
		Current (See note)	E5CN-HC2M-500 AC100-240
		Linear voltage	E5CN-HV2M-500 AC100-240
24 VAC, 50/60 Hz, 24 VDC	2	Relay (See note)	E5CN-HR2MD-500 ACDC24
		Voltage (See note)	E5CN-HQ2MD-500 ACDC24
		Current (See note)	E5CN-HC2MD-500 ACDC24
		Linear voltage	E5CN-HV2MD-500 ACDC24

Note: To order these specific models in silver add "W" to the part number (e.g. E5CN-HR2M-W-500 AC100-240); models with linear voltage output only available in black

# E5CN-HT

## Ramp/Soak Temperature & Process Controller

Quick Link

M326

### Advanced, High-Performance 1/16 DIN Size Ramp/Soak Temperature & Process Controller

- Set up to 8 program patterns with 32 segments (steps) each
- Preventive maintenance for relays in the Temperature Controller using a Control Output On/Off Counter
- Flexible logic operations (AND, OR, and delays) with contact outputs set from CX-Thermo Software
- Achieve high-speed disturbance recovery from 60 ms sampling rate



### Specifications

- Universal Input:
- Thermocouple: Types K, J, T, L, E, U, N, R, S, B, W, or PL II
- Platinum RTD input: Pt100 and JPT100
- Current input: 4-20mA, 0-20mA
- Voltage: 1 to 5V, 0 to 5V or 0 to 10V
- Thermocouple: ( $\pm 0.1\%$  of indicated value or  $\pm 1\text{ }^{\circ}\text{C}$ , whichever is greater)  $\pm 1$  digit max.
- Platinum RTD: ( $\pm 0.1\%$  of indicated value or  $\pm 0.5\text{ }^{\circ}\text{C}$ , whichever is greater)  $\pm 1$  digit max.
- Analog Input:  $\pm 0.1\%$  FS  $\pm 1$  digit max.
- CT Input:  $\pm 5\%$  FS  $\pm 1$  digit max.
- Relay Output: SPST-NO. 3A, at 250 VAC
  - 100,000 electrical operations (standard)
- Voltage Output: 12 VDC  $\pm 15\%$  for SSR, 21 mA max. load with short-circuit protection
- Current Output: 4-20mA DC, 0 to 20mA DC, 600 $\Omega$  max., approx. 10,000 resolution

### Panel Mount, Screw Terminal Ramp/Soak Temperature & Process Controllers

Supply voltage	Auxiliary outputs	Control outputs	Model (only black models listed)
100-240 VAC, 50/60 Hz	2	Relay	E5CN-HTR2M-500AC100-240
		Current	E5CN-HTC2M-500AC100-240
		Linear voltage	E5CN-HTV2M-500AC100-240
24 VAC, 50/60 Hz, 24 VDC	2	Relay	E5CN-HTR2MD-500AC/DC24
		Voltage	E5CN-HTQ2MD-500AC/DC24
		Current	E5CN-HTC2MD-500AC/DC24
		Linear voltage	E5CN-HTV2MD-500AC/DC24

# E5AN/E5EN

## Temperature & Process Controllers

Quick Link  
M224

### 1/4 and 1/8 DIN Size Controllers with 3-Color/3-Level Display

- Fast sampling rate (250 ms), short control period (0.5 s minimum) improves response
- Password protected settings limit access
- 3-color/3-level display that simultaneously displays the PV, SV, and MV status to make monitoring more informative
- ON/OFF control or 2-PID with auto-tuning for superior performance



### Specifications

- Temperature Inputs:
  - Thermocouple: Types K, J, T, L, E, U, N, R, S, B, W, or PL II
  - Platinum RTD Input: Pt100 and JPt100
  - Infrared sensor Input: 10°-70° C, 60°-120° C, 115°-165° C, 160°-260° C
  - Voltage Input: 0 to 50 mV
- Analog Inputs:
  - Current input: 4-20 mA, 0 to 20 mA
  - Voltage input: 1 to 5V, 0 to 5V, or 0 to 10V
- Relay Output: SPST-NO, 5 A at 250 VAC
  - 100,000 electrical operations (standard)
  - 1 million operations (long-life relay)
- Voltage Output for SSR: 12 VDC  $\pm$ 15%, 21 mA max. load with short-circuit protection
- Current Output: 4-20 mA DC/0-20 mA DC, load: 600  $\Omega$  max., approx. 10,000 resolution
- Accuracy: Thermocouple ( $\pm$ 0.3% of indicated value or  $\pm$ 1° C, whichever is greater)  $\pm$ 1 digit max.
- Platinum RTD: ( $\pm$ 0.2% of indicated value or  $\pm$ 0.8° C, whichever is greater)  $\pm$ 1 digit max.

### Panel Mount, Screw Terminal Temperature Process Controllers

Input type	Auxiliary outputs	Control output 1	Functions			Model Insert "A" for 1/4 DIN E5AN models. Insert "E" for 1/8 DIN E5EN models
			Heater burn-out	Sensor power supply	Control output 2	
Thermo-couple or Platinum RTD	3	Relay	---	---	---	E5_N-R3MT-500-N AC100-240
		Voltage (for SSR)				E5_N-Q3MT-500-N AC100-240
		Current				E5_N-C3MT-500-N AC100-240
		Relay	1	---	---	E5_N-R3HMT-500-N AC100-240
		Voltage (for SSR)	1			E5_N-Q3HMT-500-N AC100-240
		Relay	2	---	---	E5_N-R3HHMT-500-N AC100-240
		Voltage (for SSR)	3			E5_N-Q3HHMT-500-N AC100-240
		Relay	---	---	Voltage	E5_N-R3QMT-500-N AC100-240
		Voltage (for SSR)			Voltage	E5_N-Q3QMT-500-N AC100-240
		Current			Voltage	E5_N-C3QMT-500-N AC100-240
		Relay	---	---	Long-life relay	E5_N-R3YMT-500-N AC100-240
		Voltage (for SSR)				E5_N-Q3YMT-500-N AC100-240
		Current				E5_N-C3YMT-500-N AC100-240
		Relay	---	Yes	---	E5_N-R3PMT-500-N AC100-240
		Voltage (for SSR)		Yes		E5_N-Q3PMT-500-N AC100-240

Note: Models with 24 VAC/VDC supply voltage, also silver models available, please see complete datasheet.



## Universal Compact Digital Process Controllers

The E5\_N-H series of process controllers take the proven concept of the general purpose E5\_N series to a process level. Main features of the E5\_N-H series are universal inputs, process outputs and options such as transfer output, remote set point and set value programmer.

- Control mode: ON/OFF or 2-PID, Valve control
- Control output: Relay, voltage (pulse), SSR, linear current and voltage
- Power supply: 100-240 VAC or 24 VDC/ VAC
- Fast sampling period of 60 ms



- Easy PC connection for parameter cloning, setting and tuning
- Clear and intuitive set-up and operation

## Specifications

- Universal inputs:
  - Thermocouple: Types K, J, T, L, E, U, N, R, S, B, W, or PLII
  - Platinum RTD: Pt100 and JPt100
  - Current input: 4-20 mA, 0 to 20 mA
  - Voltage input: 1 to 5V, 0 to 5V, or 0 to 10V
- Indication Accuracy:
  - Thermocouple:  $\pm 0.1\%$  of indicated value or  $\pm 1^\circ\text{C}$ , whichever is greater  $\pm 1$  digit max.
  - Platinum RTD:  $\pm 0.1\%$  of indicated value or  $\pm 0.5^\circ\text{C}$ , whichever is greater  $\pm 1$  digit max.
  - Analog input:  $\pm 0.1\%$  FS  $\pm 1$  digit max.

## Process Controllers

Control method	Auxiliary output	Control output 1 & 2	Heater burnout	Transfer output	Model 1/4 DIN - E5AN-H models (96x96 mm) 1/8 DIN - E5EN-H models (48x96 mm)
Basic	2 alarm relays	None fitted, 2 slots*	1-phase	---	E5_N-HAA2HBM-500 AC100240
		2 SSR outputs fitted	1-phase	---	E5_N-HSS2HBM-500 AC100240
		None fitted, 2 slots*	3-phase	4 to 20 mA	E5_N-HAA2HHBFMD-500 AC100240
		2 SS outputs fitted	3-phase	4 to 20 mA	E5_N-HSS2HHBFMD-500 AC100240
	3 alarm relays	None fitted, 2 slots*	---	4 to 20 mA	E5_N-HAA3HHBFMD-500 AC100240
		2 SS outputs fitted	---	4 to 20 mA	E5_N-HSS3HHBFMD-500 AC100240
Valve	2 alarm relays	2 relay outputs fitted	---	---	E5_N-HPRR2BM-500 AC100240
		2 relay outputs fitted	---	4 to 20 mA	E5_NHPRR2BFMD-500 AC100240

\*Select 2 Control Output Units from chart below: Relay, SSR, Voltage pulse (NPN or PNP), Current or Linear voltage  
All E5EN-H/E5AN-H have 2 event inputs and Remote Set point 4 to 20 mA input.

## Output Option Boards

Output option	Model
Relay	E53-RN
Voltage (pulse) 12 VDC PNP	E53-QN
Voltage (pulse) 12 VDC NPN	E53-Q
Voltage (pulse) 24 VDC NPN	E53-Q4

Output option	Model
Linear 4 to 20 mA	E53-C3N
Linear 0 to 20 mA	E53-C3DN
Linear 0 to 10 V	E53-V34N
Linear 0 to 5 V	E53-V35N

# E5AN-HT/E5EN-HT

## Ramp/Soak Temperature & Process Controllers

Quick Link

M326

### Advanced, High-Performance 1/4 and 1/8 DIN Size Ramp/Soak Temperature & Process Controllers

- Set up to 8 program patterns with 32 segments (steps) each
- Preventive maintenance for relays in the Temperature Controller using a Control Output ON/Off Counter
- Flexible logic operations (AND, OR, and delays) with contact outputs set from CX-Thermo Software



- Achieve high-speed disturbance recovery from 60 ms sampling rate

### Specifications

- Universal Input:
  - Thermocouple: Types K, J, T, L, E, U, N, R, S, B, W, or PL II
  - Platinum RTD input: Pt100 and JPT100
  - Current input: 4-20mA, 0-20mA
  - Voltage: 1 to 5V, 0 to 5V or 0 to 10V
- Indication Accuracy:
  - Thermocouple: ( $\pm 0.1\%$  of indicated value or  $\pm 1\text{ }^{\circ}\text{C}$ , whichever is greater)  $\pm 1$  digit max.
  - Platinum RTD: ( $\pm 0.1\%$  of indicated value or  $\pm 0.5\text{ }^{\circ}\text{C}$ , whichever is greater)  $\pm 1$  digit max.
- Analog Input:  $\pm 0.1\%$  FS  $\pm 1$  digit max.
- CT Input:  $\pm 5\%$  FS  $\pm 1$  digit max.
- Output Types:
  - Relay Output: SPST-NO. 3A, at 250 VAC 100,000 electrical operations (standard)
  - Voltage Output: 12 VDC  $\pm 15\%$  for SSR, 21 mA max. load with short-circuit protection
  - Current Output: 4-20mA DC, 0 to 20mA DC, 600 $\Omega$  max., approx. 10,000 resolution

### Panel Mount, Screw Terminal Ramp/Soak Temperature & Process Controllers

Control type	Auxiliary outputs	Control output 1/2	Heater burnout	Output Functions			Model
				Event inputs	Transfer output	RSP	
Basic	3	Control Output Unit x 2	---	2	4 to 20 mA output	4 to 20 mA output	1/4 DIN - E5AN-HT (96 x 96 mm) 1/8 DIN - E5EN-HT (48 x 96 mm)
	2		1	---		E5_N-HTAA3BFM-500AC100-240	
	2		2	4 to 20 mA output		E5_N-HTAA2HBM-500AC100-240 E5_N-HTAA2HHBFM-500AC100-240	
Valve	2	Control Output Unit x 2	---	2	---	4 to 20 mA output	E5_N-HTPRR2BM-500AC100-240
	2		---	2	4 to 20 mA output		E5_N-HTPRR2BFM-500AC100-240

### Output Option Boards

Output option	Model
Relay	E53-RN
Voltage (pulse) 12 VDC, PNP	E53-QN
Voltage (pulse) 24 VDC, NPN	E53-Q3
Voltage (pulse) 24 VDC, PNP	E53-Q4

Output option	Model
Linear 4 to 20mA	E53-C3N
Linear 0 to 20 mA	E53-C3DN
Linear 0 to 10V	E53-V34N
Linear 0 to 5V	E53-V35N

G

## 1/32 DIN Size Temperature & Process Controllers with Smart Functions

- Universal temperature input available with screw terminals or cage clamp terminals
- Smart display can be set to automatically alternate between Temperature Controller status (auto/manual, RUN/STOP, and alarms) and the PV or SV
- Control output ON/OFF counter for relays supports preventive maintenance



## Specifications

- Temperature Input Models:
  - Thermocouple: K, J, T, E, L, U, N, R, S, B, W, or PL II
  - Platinum RTD: Pt100 or JPt100
  - Infrared temperature sensor: 10 to 260°C, 4 ranges
  - Voltage input: 0 to 50 mV
- Indication Accuracy:
  - Thermocouple input:  $\pm 0.3\%$  of PV
  - Pt input:  $\pm 0.2\%$  of PV
- Models with Analog Inputs:
  - Current input: 4 to 20 mA or 0 to 20 mA
  - Voltage input: 1 to 5 V, 0 to 5 V, or 0 to 10 V
- Switch among 3 colors as status changes to make the PV display more informative
- Simple PC setup using serial communication models and CX-Thermo software v4.2+

## 1/32 DIN Temperature Controllers

Control method	Control mode	No. of auxiliary outputs	Communications	Additional functions	Screw terminal model	Cage clamp terminal model
One control output; 100 to 240 VAC, 50/60 (add AC100240) or 24 VAC/VDC (add ACDC24) to the model number						
Relay output	Standard	---	---	---	E5GN-RT	E5GN-RT-C
	Standard or heat/cool	1	---	---	E5GN-R1T	E5GN-R1T-C
		1	---	2 event inputs	E5GN-R1BT	E5GN-R1BT-C
		1	RS-232C	---	E5GN-R101T-FLK	E5GN-R101T-C -FLK
		1	RS-485	---	E5GN-R103T-FLK	E5GN-R103T-FLK
		2	---	2 event inputs	E5GN-R2BT	E5GN-R2BT-C
		2	RS-485	---	E5GN-R203T-FLK	E5GN-R203T-C -FLK
Voltage output for SSR	Standard	---	---	---	E5GN-QT	E5GN-QT-C
	Standard or heat/cool	1	---	---	E5GN-Q1T	E5GN-Q1T-C
		1	---	2 event inputs	E5GN-Q1BT	E5GN-Q1BT-C
		1	RS-232C	---	E5GN-Q101T-FLK	E5GN-Q101T-C -FLK
		1	RS-485	---	E5GN-Q103T-FLK	E5GN-Q103T-C -FLK
		2	---	2 event inputs	E5GN-Q2BT	E5GN-Q2BT-C
		2	RS-485	---	E5GN-Q203T-FLK	E5GN-Q203T-C -FLK
Current output	Standard or heat/cool	1	---	---	E5GN-C1T	E5GN-C1T-C
		1	---	2 event inputs	E5GN-C1BT	E5GN-C1BT-C
		1	RS-232C	Transfer output using control output	E5GN-C101T-FLK	E5GN-C101T-C -FLK
		1	RS-485		E5GN-C103T-FLK	E5GN-C103T-FLK

Note: Models with 24 VAC/VDC supply voltage, analog input E5GN-L models available, please see complete datasheet.

## Simple to Set and Operate 1/16 DIN Size Controllers



- Easy setting using internal DIP and rotary switches
- ON/OFF or PID control (with on-demand auto-tuning) selectable
- Clearly visible digital display with character height of 13.5 mm
- Deviation indicator makes monitoring more effective
- Models with two alarms are ideal for temperature alarm applications
- Setting change protection prohibits tampering
- Sampling rate (500 ms) and selectable control period (2 and 20 s) improves response
- 8-mode alarm output and sensor error detection

- Input shift adjusts display to reflect known sensor offsets
- Accuracy  $\pm 0.5\%$  of value
- $^{\circ}\text{C}$  or  $^{\circ}\text{F}$  field selectable
- RoHS compliant
- Water-resistant front panel rated NEMA 4X/IP66
- Compact: Measures 48 H x 48 W x 78 D mm

## Specifications

- Multi-input (thermocouple/platinum resistance thermometer) type: K, J, L, T, U, N, R, Pt100, JPt100
- Relay Output: SPST-NO, 3 A at 250 VAC; 100,000 electrical operations
- Voltage Output: 12 VDC for SSR, 21 mA max. load with short-circuit protection

## Temperature Controllers

Power supply voltage	Number of alarm points	Control output	TC/Pt multi-input Case color: Black Scale marked in $^{\circ}\text{C}$	TC input Case color: Light gray Scale marked in $^{\circ}\text{C}$	Pt Input Case color: Light gray Scale marked in $^{\circ}\text{C}$	TC/Pt multi-input Case color: Black Scale marked in $^{\circ}\text{F}$
100 to 240 VAC, 50/60 Hz	0	Relay	E5CSV-RT AC100-240	---	---	E5CSV-RT-F AC100-240
		Voltage (for driving SSR)	E5CSV-QT AC100-240			E5CSV-QT-F AC100-240
	1	Relay	E5CSV-R1T AC100-240	E5CSV-R1KJ-W	E5CSV-R1P-W	E5CSV-R1T-F AC100-240
		Voltage (for driving SSR)	E5CSV-Q1T AC100-240	E5CSV-Q1KJ-W	E5CSV-Q1P-W	E5CSV-Q1T-F AC100-240
	2 (See note)	Relay	E5CSV-R2T AC100-240	---	---	E5CSV-R2T-F AC100-240
		Voltage (for driving SSR)	E5CSV-Q2T AC100-240			E5CSV-Q2T-F AC100-240
24 VAC/VDC	0	Relay	E5CSV-RTD AC/DC24			---
		Voltage (for driving SSR)	E5CSV-QTD AC/DC24			
	1	Relay	E5CSV-R1TD AC/DC24			E5CSV-R1T-DF AC/DC24
		Voltage (for driving SSR)	E5CSV-Q1TD AC/DC24			E5CSV-Q1T-DF AC/DC24
	2 (See note)	Relay	E5CSV-R2TD AC/DC24			---
		Voltage (for driving SSR)	E5CSV-Q2TD AC/DC24			

Note: Models with two alarm outputs always use the upper limit alarm mode for the alarm 2 output.

## 1/16 DIN Sized, Analog-Set Temperature Controller

- Fits standard 8-pin round sockets
- ON/OFF control models and proportional control models available
- Front panel offset adjustment on proportional control models
- Dual scale models available
- Contact or voltage output models
- Type J or K thermocouples, platinum RTD and thermistor input models
- Panel mount hardware included
- Sockets, protective cover, and other accessories available separately



## Specifications

- Thermocouple Input: Type K or J models
- Platinum RTD Input: Pt100
- Relay Output: SPDT, 3 A at 250 VAC resistive load
- Voltage (pulse) Output: 5 VDC, 10 mA max. with short-circuit protection circuit
- Voltage Types Available:
  - 100 to 120 VAC 50/60 Hz
  - 200 to 240 VAC 50/60 Hz

## Analog-Set Temperature Controllers

Input type	Temperature range	Setting accuracy	Voltage	Control type	Control output	Model
Thermocouple (K)	32°F - 1112°F	±2% max. of full scale	100/120 VAC, 50/60 Hz	ON/OFF	Relay	E5C2-R20K-32/1112F-AC120
Thermocouple (J)	0°C - 200°C and 32°F - 392°F					E5C2-R20J-0200C/32392F-AC120
	0°C - 400°C and 32°F - 752°F					E5C2-R20J-0400C/32752F-AC120
	0°C - 200°C and 32°F - 392°F			E5C2-R40J-0200C/32392F-AC120		
	0°C - 400°C and 32°F - 752°F			E5C2-R40J-0400C/32752F-AC120		
			Proportional			

## Space-Saving, Ultra-Slim Temperature Monitoring Relays

- Protect equipment against damage from excessive temperature increases
- High temperature models available up to 1700 C (3200 F)
- Wide range of functions: Alarm mode (upper limit/lower limit), enable/disable latch, C/F, relay output normally ON/OFF, setting protection
- Alarm status identification with LED indicator
- Simple DIP switch settings
- Slim design with a width of 22.5 mm screws



## Specifications

- Temperature Sensor Inputs:
  - K8AB-TH11S - Thermocouple types K,J,T,E; Platinum RTD Pt100
  - K8AB-TH12S - Thermocouple types K,J,T,E,B,R,S,PLII
- Relay Capacity: 3A at 250VAC (resistive load)
- Track-mount or surface mount with M4 screws
- Dimensions: 90 H x 22.5 W x 100 D mm

## Temperature Monitoring Relays

Description	Features	Input voltage	Output	Model
Temperature range 0° to 399°C/F	Thermocouple/RTD inputs; 1°C/F setting unit	100 to 240 VAC	SPDT relay, 3 A at 250 VAC	K8AB-TH11S 100-240 VAC
		24 VAC/VDC		K8AB-TH11S 24VAC/VDC
Temperature range 0 to 1700°C, 0 to 3200°F	Thermocouple inputs; 10°C/F setting unit	100 to 240 VAC		K8AB-TH12S 100-240 VAC
		24 VAC/VDC		K8AB-TH12S 24VAC/VDC

### Modular In-Panel Temperature/ Process Controller Easily Integrates with Host Devices

- Improves setup through high-speed program-less communications with PLCs, HMIs and Power Controller
- System expandable up to 256 loops for large area control
- Sampling period of 250 ms
- Multi-input units (2 or 4 loops): RTD, thermocouple, current and voltage inputs
- RS-232C/RS-4485 with Modbus RTU and CompoWay/F communications, and dedicated port for G3ZA power controller
- One operation loads all parameters for up to 16 controllers connected to DeviceNet unit



### Specifications



- Universal Inputs:
  - Thermocouple: K, J, T, E, L, U, N, R, S, B, W, PLII
  - RTD: Pt100, JPt100
  - Infrared Temperature Sensor: 10C to 260C
  - Current: 4 to 20, 0 to 20 mA
  - Voltage: 1 to 5, 0 to 5, 0 to 10V
- Accuracy:
  - Temperature Input (+/- 0.5% of indication value or +/- 1% C) +/-1 digit max
  - Analog Input +/- 0.5% FS +/-1 digit

### Temperature/Process Controller Basic Units

Power supply	Control loops	Control outputs 1 and 2	Control outputs 3 and 4	Functions	Communication functions	Terminal	Model
24 VDC from the End Unit	2	2 voltage outputs for SSR	2 transistor outputs (NPN)	2 heater burnout alarms; 2 event inputs	G3ZA Power Controller port: RS-485	M3 terminal	EJ1N-TC2A-QNHB
						Cage clamp	EJ1N-TC2B-QNHB
	4	2 voltage outputs for SSR	2 transistor outputs (NPN)	None	From End Unit: Port A or B: RS-485	M3 terminal	EJ1N-TC4A-QQ
						Cage clamp	EJ1N-TC4B-QQ
	2	2 current outputs	2 transistor outputs (NPN)	2 event inputs		M3 terminal	EJ1N-TC2A-CNB
						Cage clamp	EJ1N-TC2B-CNB

### Communications Units

Name	Power supply	Auxiliary output	Event inputs	Communication functions	Terminal	Model
High function unit (HFU) (See Note)	24 VDC supplied from End Unit	Transistor output: 4 points (sinking)	4	Port C: RS-485 or RS-232C selectable End Unit Port A: RS-485	M3 terminal	EJ1N-HFUA-NFLK
					4 points (sinking)	EJ1N-HFUB-NFLK
		None	None	DeviceNet	M3 terminal	EJ1N-HFUA-NFL2
					Cage clamp	EJ1N-HFUB-NFL2
End unit	24 VDC	Transistor output: 2 points (sinking)	None	Port A or B: RS-485 Connector: Port A	M3 terminal	EJ1C-EDUA-NFLK
					Detachable connector	EJ1C-EDUC-NFLK

**Note:** The End Unit is always required for connection to a Basic Controller Unit or HFU. An HFU cannot operate without a Basic Unit. External communications cannot be performed using a Basic Unit alone.

## Optimize Cycle Control for SSRs for High-Precision Heat Regulation

- Control up to 8 SSRs with one unit; lower peak current when using offset control
- Low noise, harmonics-free control reduces heater stress
- Accurate power control (within half cycle) with zero-switching control
- Dedicated communications port built into EJ1 Temperature Controllers acts as a “Smart Interface” with the G3ZA
- RS-485 communications to set manipulated variables and heater burnout detection
- Soft-start function for lamp heaters (G3ZA must be used in combination with an SSR without the zero cross function)



- Three-phase optimum cycle control provided for three-phase heaters
- Combine with a special current transformer for 150-A current detection
- Compact size (84 H x 45 W x 111 D mm) is smaller than a standard power controller

## Ordering Information

Name	Number of control channels	Heater burnout detection	Load power supply voltage	Model
Multi-channel power controller	4	Supported	100 to 240 VAC	G3ZA-4H203-FLK-UTU
			400 to 480 VAC	G3ZA-4H403-FLK-UTU
	8	Not supported	100 to 240 VAC	G3ZA-8A203-FLK-UTU
			400 to 480 VAC	G3ZA-8A403-FLK-UTU

## Specifications - Ratings

Item	Load power supply voltage range	100 to 240 VAC	400 to 480 VAC
Power supply voltage	100 to 240 VAC (50/60 Hz)		
Operating voltage range	85 to 264 VAC		
Power consumption	16 VA max.		
Load power supply voltage	100 to 240 VAC		400 to 480 VAC
Load power supply voltage range	75 to 264 VAC		340 to 528 VAC
Manipulated variable input	0.0% to 100.0% (via RS-485 communications)		
Current transformer input	Single-phase AC, 0 to 50 A (primary current of CT) Single-phase AC, 0 to 150 A (primary current of CT)		
Trigger output	One voltage output for each channel, 12 VDC ±15%, Max. load current: 21 mA (with built-in short-circuit protection circuit)		
Alarm output	NPN open collector, one output Max. applicable voltage: 30 VDC, Max. load current: 50 mA Residual voltage: 1.5 V max., Leakage current: 0.4 mA max.		
Indications	LED indicators		
Control method	Optimum cycle control Soft-start optimum cycle control (Use SSR without zero cross function) Three-phase optimum cycle control		



## DIN Track Mounting Modular Temperature Controller

- Two temperature control loops per unit occupy just 30 mm rack space
- Easily expands to 32 control loops with up to 16 E5ZN units
- Plug-in temperature controllers can be replaced without changing terminal wiring
- No power supply and communications wiring required between units when multiple units are mounted side-by-side
- CX-Thermo support software simplifies setup and monitoring via PC
- Optional 1/16 DIN Setting Display Unit for in-panel setting/monitoring
- Field selectable heating or heat/cool control
- One event input per unit



- Serial RS-485 communications built in
- Optional DeviceNet communications unit available
- Dimensions: 134.7 H x 30 W x 112 D mm (socket mounted first unit); 22.5 W for additional units

## Specifications

- Thermocouple Input: Types K, J, T, E, L, U, N, R, S, B
- Platinum RTD Input: Pt100, JPt100
- Voltage Output for SSR: 12 VDC  $\pm 15\%$  (PNP); 21 mA max.; short-circuit protection
- Transistor Output: 100 mA at 30 VDC
- Analog Current Output: 4 to 20/0 to 20 mA DC; 350  $\Omega$  max.
- Transfer Output Accuracy:  $\pm 0.5\%$  FS +0.7 mA or  $\pm 0.5\%$  FS +0.175 V

## Modular Temperature Controllers

Input type	Accuracy	Supply voltage	Control output	Auxiliary output	Additional functions	Model				
Thermocouple	$\pm 0.5\%$ or $\pm 1^\circ\text{C}$ , (whichever is greater) $\pm 1$ digit max.	24 VDC	Voltage for SSR	Transistor output: 2 pts (sinking)	Heater burnout alarm (Use E54-CT1 or E54-CT3 current transformer as detector)	E5ZN-2QNH03TC-FLK				
Platinum RTD						E5ZN-2QNH03P-FLK				
Thermocouple						E5ZN-2QPH03TC-FLK				
Platinum RTD						E5ZN-2QPH03P-FLK				
Thermocouple						E5ZN-2TNH03TC-FLK				
Platinum RTD						E5ZN-2TNH03P-FLK				
Thermocouple			Transistor	Transistor output: 2 pts (sinking)	Transistor output: 2 pts (sourcing)	Transfer output (linear voltage output)	E5ZN-2TPH03TC-FLK			
Platinum RTD							E5ZN-2TPH03P-FLK			
Thermocouple							Analog current output	Transistor output: 2 pts (sinking)	Transistor output: 2 pts (sourcing)	E5ZN-2CNF03TC-FLK
Platinum RTD										E5ZN-2CNF03P-FLK
Thermocouple							Analog current output	Transistor output: 2 pts (sinking)	Transistor output: 2 pts (sourcing)	E5ZN-2CPF03TC-FLK
Platinum RTD										E5ZN-2CPF03P-FLK

## Terminal Units

Description	Application	Dimensions	Model
Terminal units (include bus system without backplane)	For first E5ZN unit or DeviceNet unit. Equipped with terminals for power supply, communications and setting devices.	134.7 H x 30 W x 46 D mm	E5ZN-SCT24S-500
	For second and additional E5ZN units.	134.7 H x 22.5 W x 46 D mm	E5ZN-SCT18S-500

## 1/4 and 1/8 DIN Digital Controllers Offer 5-Digit, 3-Row Display

- A short 50 ms sampling period provides high-speed response
- Single-loop PID control or Single-loop heating and cooling control; multi-loop control models available
- Displays PV, SP, and MV data simultaneously in a 3-row, reverse LCD display with backlight
- Multi-loop (2 or 4 Loop types) control models offer cascade and proportional control all in one unit
- Position-proportional relay output models available for motor/valve control



## Specifications

- Input Types:
  - Thermocouple: Types K, J, T, E, L, U, N, R, S, B, W
  - Platinum RTD inputs: Pt100
  - Current Input: 4 to 20 mA DC, 0 to 20 mA DC (including remote SP input)
  - Voltage Input: 1 to 5 VDC, 0 to 5 VDC, 0 to 10 VDC (including remote SP input (Input impedance: 150 Ω for current input, approx. 1 MΩ for voltage input)
- Accuracy:
  - Temperature: ±0.1% of PV, ±1 digit
  - Analog Input: ±0.1% FS ±1 digit max.
- Output Types:
  - Voltage (pulse) Output: 12 VDC, 40 mA max. with short-circuit protection circuit
  - Current output: 0 to 20 mA DC, 4 to 20 mA DC; load: 500 Ω max. (including transfer output) (Resolution: Approx. 54,000 for 0 to 20 mA DC; Approx. 43,000 for 4 to 20 mA DC)
- Control Method: PID or ON/OFF control

## Temperature Controllers - 1/4 and 1/8 DIN Size

Size	Voltage	Control type	Control outputs	Additional features			Model
				Auxiliary outputs	Event inputs	Serial communications	
1/4 DIN	100-240 VAC, 50/60 Hz	1 Loop	2 points: Pulse voltage and Pulse voltage/current	4	2	No	E5AR-Q4B AC100-240
		1 Loop	4 points: Pulse voltage and Pulse voltage/current and Current (2 points)		6	RS-485	E5AR-QC43DB-FLK AC100-240
1/8 DIN	100-240 VAC, 50/60 Hz	1 Loop	2 points: Pulse voltage and Pulse voltage/current	4	2	No	E5ER-Q4B AC100-240
		1 Loop	4 points: Pulse voltage and Pulse voltage/current and Current (2 points)		6	RS-485	E5ER-QC43DB-FLK AC100-240

Note: For 2 or 4 loop controllers visit [www.omron247.com](http://www.omron247.com)

# Temperature Controllers

---

## Contents

<b>Selection Guide</b>		H-ii
<b>Inductive Proximity sensors</b>		
<b>Short Barrel</b>		
<b>E2E</b>	DC 2-Wire, up to 1.5x CENELEC distance, IP67 at 1200 psi	H-1
<b>E2E</b>	DC 3-Wire, standard and miniature sizes, IP67 at 1200 psi	H-5
<b>E2E</b>	AC 2-Wire, IP67 at 1200 psi	H-9
<b>E2E</b>	Miniature DC 3-Wire Cylindrical	H-11
<b>E2E-U</b>	Oil-resistant DC 2-Wire	H-12
<b>E2A</b>	DC 3-Wire, up to 2x CENELEC distance	H-13
<b>E2A</b>	DC 2-Wire, up to 2x CENELEC distance	H-14
<b>E2EM</b>	DC 2-Wire, 2x CENELEC Distance, IP67	H-15
<b>E2A3</b>	DC 3-Wire, up to 3x CENELEC distance	H-16
<b>Long Barrel</b>		
<b>E2E2</b>	DC 2-Wire up to 1.5x CENELEC distance	H-17
<b>E2E2</b>	DC 3-Wire, IP67 at 1200 psi	H-18
<b>E2E2</b>	AC 2-Wire, IP67 at 1200 psi	H-20
<b>E2A</b>	DC 3-Wire, up to 2x CENELEC distance	H-21
<b>Miniature/Block Style/Separate Amplifier</b>		
<b>E2AU</b>	DC 3-Wire, for mobile applications	H-23
<b>E2EC</b>	Miniature, 0.4 m cable between head and amp	H-24
<b>TL-W</b>	Rectangular block, DC 2-Wire and DC 3-Wire	H-25
<b>E2Q5</b>	Long distance, square head inductive	H-26
<b>E2S</b>	Subminiature block style	H-26

<b>Capacitive</b>		
<b>E2K-X</b>	Threaded cylindrical, standard sizes	H-27
<b>E2K-C</b>	Adjustable Distance Cylindrical	H-28
<b>E2K-F</b>	Flat rectangular, built-in amplifier	H-29
<b>E2K-L</b>	Liquid level detector, direct pipe mounting	H-29
<b>Harsh Environment</b>		
<b>E2F</b>	Chemical-Resistant plastic cylindrical inductive sensors	H-30
<b>E2FM</b>	All-stainless steel, inductive sensors	H-31
<b>E2EH</b>	High temperature, IP69K compliant and detergent resistant ideal for food and beverage industry	H-33
<b>E2EQ</b>	Weld spatter resistant face, inductive	H-34
<b>E2KQ-X</b>	Solid fluoroplastic cylindrical, capacitive	H-35
<b>E2FQ</b>	Weld spatter resistant inductive Stainless steel	H-35
<b>E2C-EDA</b>	High-precision positioning, inductive	H-36
<b>Special Application</b>		
<b>E2EV</b>	Detect all metals at equal distance	H-37
<b>E2CY</b>	Detects aluminum, inductive	H-37
<b>E2EY</b>	Detect only non-ferrous metals	H-38
<b>E2EZ</b>	Resists metal chip accumulation	H-38
<b>Connector Cordsets</b>		
<b>XS2F-M12</b>	M12 Cordsets	H-39
<b>XS3F-M8</b>	M8 Cordsets	H-41

# Proximity Sensors

## For machines that never stop

Our proximity sensors are designed and tested to ensure a long service life and achieve maximum machine availability even in the harshest environments.

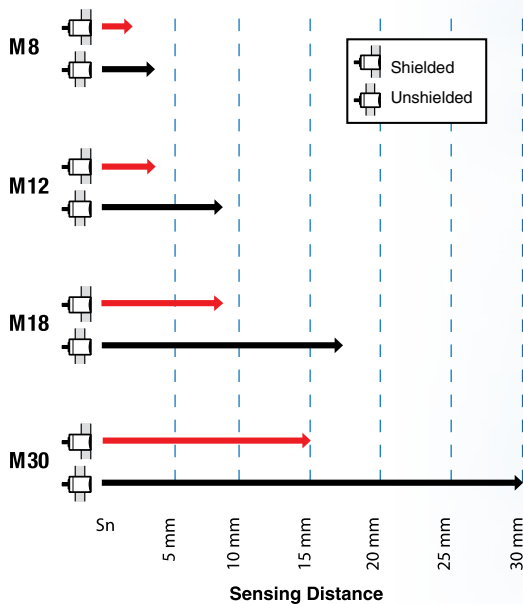

Cylindrical, Brass Housing, DC 2-Wire, DC 3-Wire and AC 2-Wire	E2E
Cylindrical brass housing, DC 3-Wire and antivalent (DC 4-Wire)	E2A
Long Barrel cylindrical brass housing, DC 2-Wire, DC 3-Wire and AC 2-Wire	E2E2
Long Barrel cylindrical brass housing DC 2-Wire	E2A



- Highest water resistance
- Highest electromagnetic noise immunity (e.g. from inverters)
- Antivalent output for cable breakage detection
- Wide connection range

## Special Applications

<p><b>e1 certified</b></p> <p><b>E2AU</b></p> <p>30 V/m electromagnetic noise immunity certified</p>	<p><b>Enhanced oil resistance</b></p> <p><b>E2E-U</b></p> <p>Tested oil resistance on commonly used lubricants</p>	<p><b>Chemical resistant plastic body</b></p> <p><b>E2F</b></p> <p>Polyarylate plastic housing</p>	<p><b>Detergent resistant</b></p> <p><b>E2EH</b></p> <p>Stainless steel housing</p>	<p><b>Metal chip immune</b></p> <p><b>E2FM</b></p> <p>All stainless steel body resists impacts, abrasive scouring</p>
--	--	--	---	---

Miniature housing:

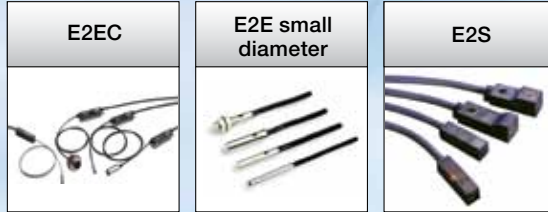

Compact square housing:



Longer distance:



Special Applications

Chemical resistant



E2FQ

Fluoro plastic (PTFE) housing



Remote amplifier



E2C-EDA

Heat resistant; Small sensing heads to fit tight spaces

Weld spatter resistant







E2EQ

Rugged fluoro resin coated brass housing

# Proximity Sensors





## Capacitive Sensors

Detect non-magnetic metals, glass, plastic, liquids, wood and leather, including liquids or solids inside non-metallic containers.

Standard cylindrical	Unthreaded cylindrical	Flat rectangular	Liquid level	Chemical resistant
				
<b>E2K-X</b>	<b>E2K-C</b>	<b>E2K-F</b>	<b>E2K-L</b>	<b>E2KQ-X</b>
ABS housing	Adjustable distance; ABS housing	Thin low-profile ABS housing for conveyor rail mounting	Detects clear and foamy liquids, mounts to sight glass and piping	Fluoroplastic resin coating



## Proximity Sensors - Special Application



Inductive sensors that are specially tuned or sized to solve tough detection problems in challenging locations.

Miniature separate amplifier	Aluminum detection	Non-ferrous metals only	Cutting chip resistant
			
<b>E2EC</b>	<b>E2CY</b>	<b>E2EY</b>	<b>E2EZ</b>
For demanding mounting conditions	Separate amplifier with compact head	Aluminum; Copper; Brass	Machine tool applications

# Selection Table



H

Category	Inductive Proximity	Inductive Proximity	Inductive Proximity
			
Model	E2E	E2A	E2E2
Product type	Short barrel cylindrical	Short barrel, extended range, cylindrical	Long barrel cylindrical
Maximum Shielded sensing distances	10 mm	15 mm	10 mm
Maximum Unshielded sensing distances	20 mm	30 mm	20 mm
DC supply voltage	12 to 24 VDC	12 to 24 VDC	12 to 24 VDC
AC supply voltage	24 to 240 VAC or 90 to 140 VAC 50/60 Hz	N/A	24 to 240 VAC or 90 to 140 VAC 50/60 Hz
Load ratings	100, 200 or 300 mA max.	100 mA max.	100, 200 or 300 mA max.
Output types	NPN, PNP, DC 2-Wire or SCR	NPN or PNP	NPN, PNP, DC 2-Wire or SCR
Output state	N.O. or N.C.	N.O. or N.C.	N.O. or N.C.
Connections	Pre-wired, connector	Pre-wired, connector	Pre-wired, connector
IP rating	IP67	IP67	IP67



Category	Inductive Proximity	Inductive Proximity	Inductive Proximity
			
Model	E2A	E2E-U	E2EM
Product type	Long barrel, extended range cylindrical	Oil resistant cylindrical	Short barrel, extended range cylindrical
Maximum Shielded sensing distances	15 mm	10 mm	15 mm
Maximum Unshielded sensing distances	30 mm	N/A	30 mm
DC supply voltage	12 to 24 VDC	12 to 24 VDC	12 to 24 VDC
AC supply voltage	N/A	N/A	N/A
Load ratings	100 mA max.	100 mA max.	100 mA and 200 mA max.
Output types	NPN or PNP	DC 2-wire	NPN, PNP, or DC 2-wire
Output state	N.O. or N.C.	N.O. or N.C.	N.O. or N.C.
Connections	Pre-wired, connector	Pre-wired, connector	Pre-wired, connector
IP rating	IP67	IP67 and IP67g	IP67







## Selection Table



Category	Inductive Proximity	Inductive Proximity	Inductive Proximity
			
Model	E2A3	E2AU	E2EC
Product type	Short barrel, extra long-distance cylindrical	Cylindrical proximity sensor for mobile usage	Subminiature cylindrical with long-distance detection
Maximum Shielded sensing distances	20 mm	15 mm	4 mm
Maximum Unshielded sensing distances	N/A (Shielded only)	N/A (Shielded only)	N/A (Shielded only)
DC supply voltage	12 to 24 VDC	12 to 24 VDC	12 to 24 VDC and 5 to 24 VDC
AC supply voltage	N/A	N/A	N/A
Load ratings	200 mA max.	200 mA max.	100 mA max.
Output types	NPN or PNP	PNP	NPN, PNP, or DC 2-Wire
Output state	N.O. or N.C.	N.O.	N.O. or N.C.
Connections	Pre-wired, connector	Pre-wired, connector	Pre-wired
IP rating	IP67	IP69k	IP64 and IP67

Category	Inductive Proximity	Inductive Proximity	Inductive Proximity
			
Model	TL-W	E2Q5	E2S
Product type	Flat rectangular proximity sensor	Long distance square proximity sensor	Super-compact rectangular proximity sensor
Maximum Shielded sensing distances	5 mm	20 mm	N/A
Maximum Unshielded sensing distances	20 mm	40 mm	2.5 mm
DC supply voltage	12 to 24 VDC	10 to 30 VDC	12 to 24 VDC
AC supply voltage	N/A	N/A	N/A
Load ratings	100 mA and 200 mA max.	200 mA max.	50 mA max.
Output types	NPN, PNP, or DC 2-wire	NPN or PNP	NPN, PNP and DC 2-Wire
Output state	N.O. or N.C.	N.O. or N.O. + N.C.	N.O. or N.C.
Connections	Pre-wired	M12 quick disconnect	Pre-wired
IP rating	IP67	IP67 and IP69k	IP67

Category	Capacitive Proximity	Capacitive Proximity	Capacitive Proximity
			
Model	E2K-X	E2K-C	E2K-F
Product type	General purpose threaded cylindrical capacitive sensor	Long-distance cylindrical capacitive sensor with adjustable sensitivity	Flat proximity sensor
Maximum Shielded sensing distances	N/A	N/A	N/A
Maximum Unshielded sensing distances	15 mm	25 mm	10 mm
DC supply voltage	12 to 24 VDC	12 to 24 VDC and 24 to 240 VDC	12 to 24 VDC
AC supply voltage	100 to 220 VAC, 50/60 Hz	100 to 220 VAC, 50/60 Hz and 24 to 240 VAC 50/60 Hz	N/A
Load ratings	200 mA max.	200 mA and 250 mA max.	100 mA max.
Output types	NPN, PNP and SCR	NPN, PNP and SCR	NPN
Output state	N.O. or N.C.	N.O. or N.C.	N.O. or N.C.
Connections	Pre-wired	Pre-wired	Pre-wired
IP rating	IP66	IP66, IP67	IP64, IP66

Category	Capacitive Proximity	Inductive Proximity	Inductive Proximity
			
Model	E2K-L	E2F	E2FM
Product type	Liquid level sensor	Cylindrical proximity sensor with resin case and superb water resistance	Highly durable cylindrical proximity sensor for tough environments
Maximum Shielded sensing distances	N/A	10 mm	10 mm
Maximum Unshielded sensing distances	1.5 mm	N/A	N/A
DC supply voltage	12 to 24 VDC	12 to 24 VDC	12 to 24 VDC
AC supply voltage	N/A	90 to 140 VAC and 24 to 240 VAC	N/A
Load ratings	100 mA max.	100, 200, 300 and 500 mA max.	100 mA and 200 mA max.
Output types	NPN	NPN, PNP and SCR	NPN, PNP and DC 2-Wire
Output state	N.O.	N.O. or N.C.	N.O. or N.C.
Connections	Pre-wired	Pre-wired	Pre-wired, connector
IP rating	IP64, IP66	IP68	IP67

Category	Inductive Proximity	Inductive Proximity	Capacitive Proximity
			
Model	E2EH	E2EQ	E2KQ-X
Product type	High temperature detergent resistant cylindrical proximity sensor	Spatter-resistant fluororesin coated proximity sensor	Fluororesin coated, chemical resistant capacitive sensor with sensitivity adjuster
Maximum Shielded sensing distances	12 mm	15 mm	N/A
Maximum Unshielded sensing distances	N/A	N/A	10 mm
DC supply voltage	12 to 24 VDC	12 to 24 VDC	12 to 24 VDC
AC supply voltage	N/A	N/A	N/A
Load ratings	50 mA and 100 mA max.	100 mA max.	100 mA max.
Output types	NPN, PNP and DC 2-Wire	DC 2-Wire	NPN
Output state	N.O. or N.C.	N.O. or N.C.	N.O. or N.C.
Connections	Pre-wired, connector	Pre-wired, connector	Pre-wired
IP rating	IP67, IP69k	IP67	IP66

Category	Inductive Proximity	Inductive Proximity
		
Model	E2FQ	E2C-EDA
Product type	Fluororesin coated, chemical resistant Inductive sensor	High precision positioning proximity sensor with separate digital amplifier
Maximum Shielded sensing distances	10 mm	5 mm
Maximum Unshielded sensing distances	N/A	7 mm
DC supply voltage	12 to 24 VDC	12 to 24 VDC
AC supply voltage	N/A	N/A
Load ratings	100, 200 and 300 mA max.	50 mA max.
Output types	NPN, DC 2-wire and SCR	NPN and PNP
Output state	N.O.	N.O. or N.C.
Connections	Pre-wired	Pre-wired, connector
IP rating	IP67	IP50, IP60, IP67

## Short-Barrel DC 2-Wire Proximity Sensors Reduce Wiring to Control Devices

- Thick nickel-plated brass (NPB) barrel
- Wrench flats for easy installation
- Solid potted internal circuitry withstands shocks
- IP67 rated, 1200 psi water wash-down
- Up to 50% longer sensing range than CENELEC standards
- High-visibility indicator
- Flush mountable shielded versions
- Built-in circuit protection
- Normally Open (NO) circuit type stocked; Normally Closed (NC) available
- Sensor mounting and protective accessories, see Y92E



## DC 2-Wire Sensors with Self-Diagnostic Output Function

Pre-Wired with 2 m cable

Size	Sensing Distance (mm)	Shielded	Circuit Type	Response Frequency	Body Material	Thread Length (overall length) mm	Model
M12	3.0	Yes	NO	1000 Hz	NPB	33 (38)	E2E-X3D1S
	8.0	No		800 Hz		26 (38)	E2E-X8MD1S
M18	7.0	Yes		500 Hz		38 (43)	E2E-X7D1S
	14.0	No		400 Hz		28 (43)	E2E-X14MD1S
M30	10.0	Yes		43 (48)		E2E-X10D1S	
	20.0	No		100 Hz		35 (48)	E2E-X20MD1S

## DC 2-Wire Sensors with Built-In M12 Micro-Change® Connectors

### DC 2-Wire sensors normally open

Note: Terminal 1 is not used

Size	Sensing Distance (mm)	Shielded	Circuit Type	Response Frequency	Body Material	Thread Length (overall length) mm	Model
M12	3.0	Yes	NO	1000 Hz	NPB	26 (48)	E2E-X3D1S-M1
	8.0	No		800 Hz		33 (48)	E2E-X8MD1S-M1
M18	7.0	Yes		500 Hz		38 (53)	E2E-X7D1S-M1
	14.0	No		400 Hz		28 (53)	E2E-X14MD1S-M1
M30	10.0	Yes		43 (58)		E2E-X10D1S-M1	
	20.0	No		100 Hz		30 (58)	E2E-X20MD1S-M1

### DC 2-Wire Sensors without Diagnostic Output Function

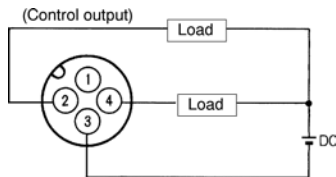

Pre-Wired with 2 m cable

Size	Sensing Distance (mm)	Shielded	Circuit Type	Response Frequency	Body Material	Thread Length (overall length) mm	Model
M8	2.0	Yes	NO	1500 Hz	SUS	26 (30)	E2E-X2D1-N
	4.0	No		1000 Hz		20 (30)	E2E-X2D2-N
E2E-X4MD1-N							
E2E-X4MD2-N							
M12	3.0	Yes		NPB	800 Hz	33 (38)	E2E-X3D1-N
	8.0	No				26 (38)	E2E-X3D2-N
E2E-X8MD1-N							
E2E-X8MD2-N							
M18	7.0	Yes			500 Hz	38 (43)	E2E-X7D1-N
	14.0	No					28 (43)
E2E-X14MD1-N							
E2E-X14MD2-N							
M30	10.0	Yes	43 (48)	E2E-X10D1-N			
	20.0	No			100 Hz	30 (48)	E2E-X10D2-N
E2E-X20MD1-N							
E2E-X20MD2-N							

## DC 2-Wire Sensors with Built-In M12 Micro-Change® Connectors

DC 2-Wire sensors

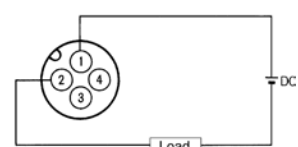
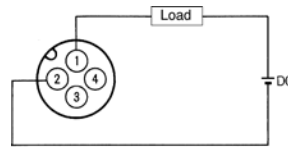
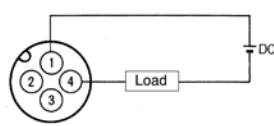
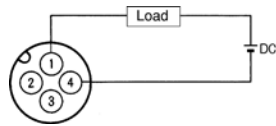

Note: Terminals 2 and 3 are not used

Note: Terminals 3 and 4 are not used

Size	Sensing Distance (mm)	Shielded	Circuit Type	Response Frequency	Body Material	Thread Length (overall length) mm	Model
M8	2.0	Yes	NO	1500 Hz	SUS	26 (43)	E2E-X2D1-M1G
	4.0	No		1000 Hz		20 (43)	E2E-X2D2-M1G
E2E-X4MD1-M1G							
M12	3.0	Yes		800 Hz		NPB	33 (48)
	8.0	No			500 Hz		26 (48)
M18				7.0		Yes	
	14.0	No		28 (53)	E2E-X8MD2-M1G		
M30					10.0	Yes	100 Hz
	20.0	No		30 (58)	E2E-X7D2-M1G		
E2E-X14MD1-M1G							
E2E-X14MD2-M1G							
E2E-X10D1-M1G							
E2E-X10D2-M1G							
E2E-X20MD1-M1G							
E2E-X20MD2-M1G							

## DC 2-Wire Sensors without Diagnostic Output Function

For Micro-Change® use OMRON Y96E-44□D□ connector cordsets. Models with no polarity have a residual voltage of 5V.

Normally Open, No Polarity (-M1J-T)

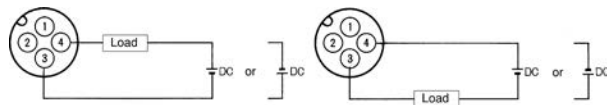

Normally Open with Polarity (-M1GJ)



Note: 1. Terminals 2 and 3 are not used

2. Terminals 3 and 4 have no polarity.

Note: Terminals 2 and 3 are not used

Size	Sensing Distance (mm)	Shielded	Circuit Type	Response Frequency	Body Material	Thread Length (overall length) mm	Model
M12	3.0	Yes	NO, polarity	1000 Hz	NPB	33 (48)	E2E-X3D1-M1GJ
			NO, no polarity				E2E-X3D1-M1J-T
8.0	No	NO, polarity	800 Hz	26 (48)		E2E-X8MD1-M1GJ	
						M18	7.0
14.0	No	NO, no polarity	400 Hz	28 (53)	E2E-X7D1-M1J-T		
					M30	10.0	Yes
20.0	No	NO, polarity	30 (58)	E2E-X10D1-M1GJ			
				E2E-X10D1-M1J-T			
E2E-X20MD1-M1GJ							

## DC 2-Wire Sensors with Built-In M8 NanoChange® Connectors

DC 2-Wire sensors

For NanoChange® use Omron XS3F-M42□-40□-R connector cordsets.

Normally open

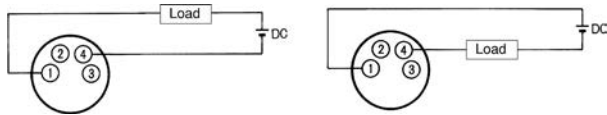

Note: Terminals 2 and 3 are not used

Normally closed

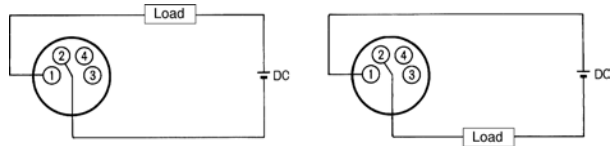

Note: Terminals 3 and 4 are not used

Size	Sensing Distance (mm)	Shielded	Circuit Type	Response Frequency	Body Material	Thread Length (overall length) mm	Model
M8	3.0	Yes	NO	1000 Hz	SUS	31 (39)	E2E-X2D1-M3G
			NC				E2E-X2D2-M3G
	8.0	No	NO	1000 Hz		25 (39)	E2E-X4MD1-M3G
			NC				E2E-X4MD2-M3G

## DC 2-Wire Sensors without Diagnostic Output Function

For Micro-Change® use OMRON Y96E-44□D□ connector cordsets. Models with no polarity have a residual voltage of 5V.

Normally Open, No Polarity (-M1J-T)

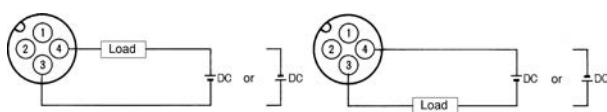

Note: 1. Terminals 2 and 3 are not used

2. Terminals 3 and 4 have no polarity.

Normally Open with Polarity (-M1GJ)

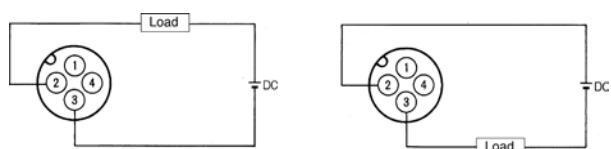

Note: Terminals 2 and 3 are not used

Size	Sensing Distance (mm)	Shielded	Circuit Type	Response Frequency	Body Material	Thread Length (overall length) mm	Model
M8	2.0	Yes	NO	1500 Hz	SUS	26 (43)	E2E-X2D1-M1
							E2E-X2D2-M1
	4.0	No		1000 Hz		20 (43)	E2E-X4MD1-M1
							E2E-X4MD2-M1
M12	3.0	Yes		NPB	800 Hz	33 (48)	E2E-X3D1-M1
							E2E-X3D2-M1
	8.0	No			26 (48)	E2E-X8MD1-M1	
						E2E-X8MD2-M1	
M18	7.0	Yes	400 Hz	38 (53)	28 (53)	E2E-X7D1-M1	
						E2E-X7D2-M1	
	14.0	No		28 (53)	E2E-X14MD1-M1		
					E2E-X14MD2-M1		
M30	10.0	Yes	100 Hz	43 (58)	30 (58)	E2E-X10D1-M1	
						E2E-X10D2-M1	
	20.0	No		30 (58)	E2E-X20MD1-M1		
					E2E-X20MD2-M1		

## Short-Barrel DC 3-Wire Proximity Sensors Reduce Wiring to Control Devices

- Thick nickel-plated brass (NPB) barrel
- Wrench flats for easy installation
- Solid potted internal circuitry withstands shocks
- IP67 rated, 1200 psi water washdown
- Up to 25% longer sensing range than CENELEC standards
- High-visibility indicator
- Voltage output eliminates the need for pull up/down resistors (standard models)
- Flush mountable shielded versions
- Built-in circuit protection
- Miniature sizes: 4 mm, M5 and 5.4 mm



- Normally Open (NO) and Normally Closed (NC) available
- Sensor mounting and protective accessories, see Y92E

## DC 3-Wire DC Sensors

Pre-Wired with 2 m Cable, Normally Open

Size	Sensing Distance (mm)	Shielded	Circuit Type	Response Frequency	Body Material	Thread Length (overall length) mm	Model	
M8	1.5	Yes	NPN-NO	2 kHz	SUS	26 (30)	E2E-X1R5E1	
			PNP-NO				E2E-X1R5F1	
	2.0	No	NPN-NO	800 Hz		20 (30)	E2E-X2ME1	
			PNP-NO				E2E-X2MF1	
M12	2.0	Yes	NPN-NO	1.5 kHz	NPB	33 (38)	E2E-X2E1	
			PNP-NO				E2E-X2F1	
	5.0	No	NPN-NO	400 Hz		26 (38)	E2E-X5ME1	
			PNP-NO				E2E-X5MF1	
			38 (43)			NPN-NO	600 Hz	E2E-X5E1
						PNP-NO		E2E-X5F1
M18	10.0	No	NPN-NO	200 Hz	28 (43)	E2E-X10ME1		
			PNP-NO			E2E-X10MF1		
	43 (48)	NPN-NO	400 Hz	E2E-X10E1				
		PNP-NO		E2E-X10F1				
M30	10.0	Yes	NPN-NO	400 Hz	30 (48)	E2E-X18ME1		
			PNP-NO			E2E-X18MF1		
	18.0	No	NPN-NO	100 Hz		E2E-X18ME1		
			PNP-NO			E2E-X18MF1		



## DC 3-Wire Sensors, Pre-Wired with 2 m Cable, Normally Closed

Size	Sensing Distance (mm)	Shielded	Circuit Type	Response Frequency	Body Material	Thread Length (overall length) mm	Model
M8	1.5	Yes	NPN-NC	2 kHz	SUS	26 (30)	E2E-X1R5E2
			PNP-NC				E2E-X1R5F2
M8	2.0	No	NPN-NC	800 Hz		20 (30)	E2E-X2ME2
			PNP-NC				E2E-X2MF2
M12	2.0	Yes	NPN-NC	1.5 kHz	NPB	33 (38)	E2E-X2E2
			PNP-NC				E2E-X2F2
	5.0	No	NPN-NC	400 Hz		26 (38)	E2E-X5ME2
			PNP-NC				E2E-X5MF2
M18	2.0	Yes	NPN-NC	600 Hz		38 (43)	E2E-X5E2
			PNP-NC				E2E-X5F2
	10.0	No	NPN-NC	200 Hz		28 (43)	E2E-X10ME2
			PNP-NC				E2E-X10MF2
M30	2.0	Yes	NPN-NC	400 Hz		43 (48)	E2E-X10E2
			PNP-NC				E2E-X10F2
	18.0	No	NPN-NC	100 Hz		30 (48)	E2E-X18ME2
			PNP-NC				E2E-X18MF2

## DC 3-Wire Sensors with Built-In M12 Micro-Change® Connectors, Normally Open

NPN Normally Open (E1-M1)

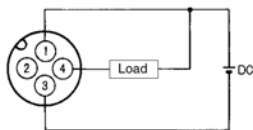

PNP Normally Open (F1-M1)

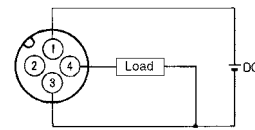

Note: Terminal 2 is not used

Note: Terminal 2 is not used

Size	Sensing Distance (mm)	Shielded	Circuit Type	Response Frequency	Body Material	Thread Length (overall length) mm	Model
M8	1.5	Yes	NPN-NO	2 kHz	SUS	26 (43)	E2E-X1R5E1-M1
			PNP-NO				E2E-X1R5F1-M1
	2.0	No	NPN-NO	800 Hz		20 (43)	E2E-X2ME1-M1
			PNP-NO				E2E-X2MF1-M1
M12	2.0	Yes	NPN-NO	1.5 kHz	NPB	33 (48)	E2E-X2E1-M1
			PNP-NO				E2E-X2F1-M1
	5.0	No	NPN-NO	400 Hz		26 (48)	E2E-X5ME1-M1
			PNP-NO				E2E-X5MF1-M1
M18	2.0	Yes	NPN-NO	600 Hz		38 (53)	E2E-X5E1-M1
			PNP-NO				E2E-X5F1-M1
	10.0	No	NPN-NO	200 Hz		28 (53)	E2E-X10ME1-M1
			PNP-NO				E2E-X10MF1-M1
M30	2.0	Yes	NPN-NO	400 Hz		43 (58)	E2E-X10E1-M1
			PNP-NO				E2E-X10F1-M1
	18.0	No	NPN-NO	100 Hz		30 (58)	E2E-X18ME1-M1
			PNP-NO				E2E-X18MF1-M1

## DC 3-Wire Sensors with Built-In M12 Micro-Change® Connectors, Normally Closed

NPN Normally Closed

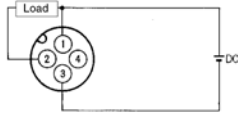

Note: Terminal 4 is not used

PNP Normally Closed

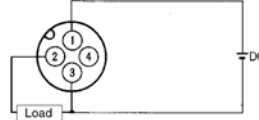

Note: Terminal 4 is not used

Size	Sensing Distance (mm)	Shielded	Circuit Type	Response Frequency	Body Material	Thread Length (overall length) mm	Model
M8	1.5	Yes	NPN-NO	2 kHz	SUS	26 (43)	E2E-X1R5E2-M1
			PNP-NO				E2E-X1R5F2-M1
	2.0	No	NPN-NO	800 Hz		20 (43)	E2E-X2ME2-M1
			PNP-NO				E2E-X2MF2-M1
M12	5.0	Yes	NPN-NO	1.5 kHz	NPB	33 (48)	E2E-X2E2-M1
			PNP-NO				E2E-X2F2-M1
	5.0	No	NPN-NO	400 Hz		26 (48)	E2E-X5ME2-M1
			PNP-NO				E2E-X5MF2-M1
M18	10.0	Yes	NPN-NO	600 Hz	38 (53)	E2E-X5E2-M1	
			PNP-NO				E2E-X5F2-M1
	10.0	No	NPN-NO	200 Hz		28 (53)	E2E-X10ME2-M1
			PNP-NO				E2E-X10MF2-M1
M30	18.0	Yes	NPN-NO	400 Hz	43 (58)	E2E-X10E2-M1	
			PNP-NO				E2E-X10F2-M1
	18.0	No	NPN-NO	100 Hz		30 (58)	E2E-X18ME2-M1
			PNP-NO				E2E-X18MF2-M1

## DC 3-Wire Sensors with Built-In M8 NanoChange® Connectors

For NanoChange® use Omron XS3F-M42□-40□-R connector cordsets or Brad Harrison equivalent.

NPN Normally Open (E1-M3)

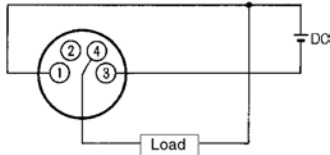

Note: Terminal 2 is not used

PNP Normally Open (F1-M3)

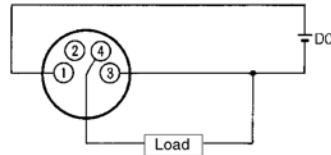

Note: Terminal 2 is not used

NPN Normally Closed (E2-M3)

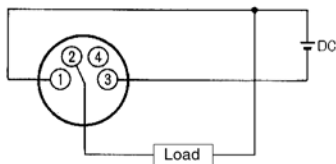

Note: Terminal 4 is not used

PNP Normally Closed (F2-M3)

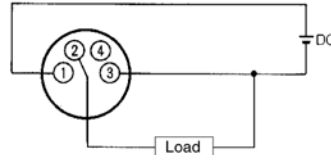

Note: Terminal 4 is not used

## DC 3-Wire Sensors with Built-In M8 NanoChange® Connectors

Size	Sensing Distance (mm)	Shielded	Circuit Type	Response Frequency	Body Material	Thread Length (overall length) mm	Model
M8	1.5	Yes	NPN-NO	2 kHz	SUS	26 (39)	E2E-X1R5E1-M3
			NPN-NC				E2E-X1R5E2-M3
			PNP-NO				E2E-X1R5F1-M3
			PNP-NC				E2E-X1R5F2-M3
	8.0	No	NPN-NO	800 Hz	SUS	20 (39)	E2E-X2ME1-M3
			NPN-NC				E2E-X2ME2-M3
			PNP-NO				E2E-X2MF1-M3
			PNP-NC				E2E-X2MF2-M3

## Miniature DC 3-Wire, Pre-Wired with 2 m Cable

Size (dia.)	Sensing Distance (mm)	Shielded	Circuit Type	Response Frequency	Body Material	Thread Length (overall length) mm	Model
4 mm	0.8	Yes	NPN-NO	3 kHz	SUS	26 (30)	E2E-CR8C1
			NPN-NC				E2E-CR8C2
			PNP-NO			20 (30)	E2E-CR8B1
			PNP-NC				E2E-CR8B2
M5	1.0		NPN-NO	3 kHz	NPB	33 (38)	E2E-X1C1
			NPN-NC				E2E-X1C2
			PNP-NO			26 (38)	E2E-X1B1
			PNP-NC				E2E-X1B2
5.4 mm	1.0	NPN-NO	3 kHz	NPB	38 (43)	E2E-C1C1	
		NPN-NC				E2E-C1C2	
		PNP-NO			28 (43)	E2E-C1B1	
		PNP-NC				E2E-C1B2	

## Short-Barrel AC 2-Wire Proximity Sensors

- Thick nickel-plated brass (NPB) barrel
- Wrench flats for easy installation
- Solid potted internal circuitry withstands shocks
- IP67 rated, 1200 psi water wash-down
- Up to 50% longer sensing range than CENELEC standards
- High-visibility indicator
- Flush mountable shielded versions
- Short-circuit protection models available
- Normally Open (NO) models stocked; Normally Closed (NC) available
- Sensor mounting and protective accessories, see Y92E



## AC 2-Wire Sensors with Self-Diagnostic Output Function

Pre-Wired with 2 m cable

Size	Sensing Distance (mm)	Shielded	Circuit Type	Response Frequency	Body Material	Thread Length (overall length) mm	Model
M8	1.5	Yes	NO	25 Hz	SUS	36 (40)	E2E-X1R5Y1
	2.0	No				30 (40)	E2E-X2MY1-US
M12		5.0			Yes	NPB	38 (43)
	5.0	No			31 (43)		E2E-X5MY1-US
M18		10.0			Yes		38 (43)
	10.0	No			28 (43)		E2E-X10MY1-US
M30		18.0			Yes		43 (48)
	18.0	No			30 (48)		E2E-X18MY1-US

## AC 2-Wire Sensors with Built-In M12 Micro-Change® Connectors

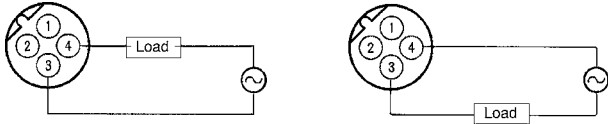

Note: Terminals 1 and 2 are not used

Size	Sensing Distance (mm)	Shielded	Circuit Type	Response Frequency	Body Material	Thread Length (overall length) mm	Model
M12	2.0	Yes	NO	25 Hz	NPB	38 (53)	E2E-X2Y1-M1
	5.0	No				31 (53)	E2E-X5MY1-M1
M18		Yes				38 (53)	E2E-X5Y1-M1
	10.0	No				28 (53)	E2E-X10MY1-M1
M30		Yes				43 (48)	E2E-X10Y1-M1
	18.0	No				30 (48)	E2E-X18MY1-M1

## AC 2-Wire Sensors with M12, 3-Pin Dual Key-Way Micro-Change® Connectors

Normally Open

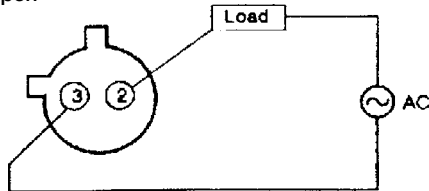

Size	Sensing Distance (mm)	Shielded	Circuit Type	Response Frequency	Body Material	Thread Length (overall length) mm	Model
M12	2.0	Yes	NO	25 Hz	NPB	38 (53)	E2E-X2Y1-M4
	5.0	No				31 (53)	E2E-X5MY1-M4
M18		Yes				38 (53)	E2E-X5Y1-M4
	10.0	No				28 (53)	E2E-X10MY1-M4
M30		Yes				43 (58)	E2E-X10Y1-M4
	18.0	No				30 (58)	E2E-X18MY1-M4

## AC 2-Wire Sensors, Pre-Wired with 2 m Cable

Size	Sensing Distance (mm)	Shielded	Circuit Type	Response Frequency	Body Material	Thread Length (overall length) mm	Model
M12	5.0	Yes	SCR-NO	25 Hz	NPB	29 (47)	E2E-X5Y1-53-US
	10.0	No				19 (47)	E2E-X10MY1-53-US
M18		Yes				38 (57)	E2E-X10Y1-53-US
	18.0	No				25 (57)	E2E-X18MY1-53-US

## Miniature Inductive Proximity Sensor in Cylindrical Metal Housing

The E2E Small Diameter line with housing sizes from 3 mm dia to 5.4 mm dia is part of the E2E family and is the ideal solution where space is crucial. The metal housing provides high mechanical protection.



- Miniature housing sizes from 3 mm dia to 5.4 mm dia
- Stainless steel or brass housing
- 3 kHz switching frequency

### DC 3-Wire Sensors, Pre-wired with 2 m Cable

Size			Sensing Distance	Housing Material	Output Type	Model (for pre-wired types with 2 m cable length)		
						Operation Mode NO	Operation Mode NC	
3 mm dia		-	0.6 mm	Stainless Steel	PNP	E2E-CR6B1	E2E-CR6B2	
					NPN	E2E-CR6C1	E2E-CR6C2	
4 mm dia			0.8 mm		PNP	E2E-CR8B1	E2E-CR8B2	
					NPN	E2E-CR8C1	E2E-CR8C2	
M5			1 mm	Brass	PNP	E2E-X1B1	E2E-X1B2	
					NPN	E2E-X1C1	E2E-X1C2	
5.4 mm dia				Cylindrical	Cylindrical	PNP	E2E-C1B1	E2E-C1B2
						NPN	E2E-C1C1	E2E-C1C2

### DC 3-Wire Sensors, Connector Versions (M8, 3-pin)

Size			Sensing Distance	Housing Material	Output Type	Model (for M8 3-pin connector types)	
						Operation Mode NO	Operation Mode NC
4 mm dia		-	0.8 mm	Stainless Steel	PNP	E2E-CR8B1-M5	E2E-CR8B2-M5
					NPN	E2E-CR8C1-M5	E2E-CR8C2-M5
M5			1 mm	Brass	PNP	E2E-X1B1-M5	E2E-X1B2-M5
					NPN	E2E-X1C1-M5	E2E-X1C2-M5

## Oil Resistant Inductive Sensor in Cylindrical Brass Housing

The standard E2E family offers tested oil resistance on commonly used oils in the automotive industry for reliable long-life operation in automotive assembly lines.

- Oil resistant PUR cable
- M8, M12, M18 and M30 standard sizes
- IP67 (water and oil resistant)



### DC 2-wire, Pre-Wired

Size		Sensing Distance	Model (for pre-wired types with 2 m cable length)	
			Operation Mode NO	Operation Mode NC
M8	■	2 mm	E2E-X2D1-U	E2E-X2D2-U
M12		3 mm	E2E-X3D1-U	E2E-X3D2-U
M18		7 mm	E2E-X7D1-U	E2E-X7D2-U
M30		10 mm	E2E-X10D1-U	E2E-X10D2-U

### DC 2-wire, Pre-Wired with M12

Size		Sensing Distance	Model (for pre-wired types with 30 cm cable length and M12 connector)	
			Operation Mode NO	Operation Mode NC
M8	■	2 mm	E2E-X2D1-M1TGJ-U 0.3M	E2E-X2D2-M1TGJ-U 0.3M
M12		3 mm	E2E-X3D1-M1TGJ-U 0.3M	E2E-X3D2-M1TGJ-U 0.3M
M18		7 mm	E2E-X7D1-M1TGJ-U 0.3M	E2E-X7D2-M1TGJ-U 0.3M
M30		10 mm	E2E-X10D1-M1TGJ-U 0.3M	E2E-X10D2-M1TGJ-U 0.3M

## Extended Sensing Range Inductive Sensor in Cylindrical Brass Housing

The high quality and the long-life design of the E2A extended sensing distance provide the best value performance ratio for standard applications



- Extended (double) sensing distance
- IP67 and IP69k for highest water protection
- DC 3-wire (NO, NC), DC 4-wire (NO+NC)
- Wide installation and connectivity range through modular concept

### DC 3-Wire Sensors, Pre-Wired

(For different cable materials and lengths, special housing length or special connectors, please refer to complete datasheet)

Size			Sensing Distance	Thread Length (overall length)	Output Type	Model (for pre-wired types with 2m cable length)		
						Operation Mode NO	Operation Mode NC	Operation Mode NO + NC
M8	■	—	2.0 mm	27 (40) mm	PNP <sup>1</sup>	E2A-S08KS02-WP-B1 2M	E2A-S08KS02-WP-B2 2M	E2A-S08LS02-WP-B3 2M <sup>2</sup>
	—	■	4.0 mm	21 (40) mm	PNP <sup>1</sup>	E2A-S08KN04-WP-B1 2M	E2A-S08KN04-WP-B2 2M	E2A-S08LN04-WP-B3 2M <sup>2</sup>
M12	■	—	4.0 mm	34 (50) mm	PNP <sup>1</sup>	E2A-M12KS04-WP-B1 2M	E2A-M12KS04-WP-B2 2M	E2A-M12KS04-WP-B3 2M
	—	■	8.0 mm	27 (50) mm	PNP <sup>1</sup>	E2A-M12KN08-WP-B1 2M	E2A-M12KN08-WP-B2 2M	E2A-M12KN08-WP-B3 2M
M18	■	—	8.0 mm	39 (59) mm	PNP <sup>1</sup>	E2A-M18KS08-WP-B1 2M	E2A-M18KS08-WP-B2 2M	E2A-M18KS08-WP-B3 2M
	—	■	16.0 mm	29 (59) mm	PNP <sup>1</sup>	E2A-M18KN16-WP-B1 2M	E2A-M18KN16-WP-B2 2M	E2A-M18KN16-WP-B3 2M
M30	■	—	15.0 mm	44 (64) mm	PNP <sup>1</sup>	E2A-M30KS15-WP-B1 2M	E2A-M30KS15-WP-B2 2M	E2A-M30KS15-WP-B3 2M
	—	■	20.0 mm	29 (64) mm	PNP <sup>1</sup>	E2A-M30KN20-WP-B1 2M	E2A-M30KN20-WP-B2 2M	E2A-M30KN20-WP-B3 2M

### DC 3-Wire Sensors, Connector Versions (M12)



Size			Sensing Distance	Thread Length (overall length)	Output Type	Model (for M12 connector types)		
						Operation Mode NO	Operation Mode NC	Operation Mode NO + NC
M8	■	—	2.0 mm	27 (40) mm	PNP <sup>1</sup>	E2A-S08KS02-M1-B1	E2A-S08KS02-M1-B2	E2A-S08LS02-M1-B3 <sup>2</sup>
	—	■	4.0 mm	21 (40) mm	PNP <sup>1</sup>	E2A-S08KN04-M1-B1	E2A-S08KN04-M1-B2	E2A-S08LN04-M1-B3 <sup>2</sup>
M12	■	—	4.0 mm	34 (50) mm	PNP <sup>1</sup>	E2A-M12KS04-M1-B1	E2A-M12KS04-M1-B2	E2A-M12KS04-M1-B3
	—	■	8.0 mm	27 (50) mm	PNP <sup>1</sup>	E2A-M12KN08-M1-B1	E2A-M12KN08-M1-B2	E2A-M12KN08-M1-B3
M18	■	—	8.0 mm	39 (59) mm	PNP <sup>1</sup>	E2A-M18KS08-M1-B1	E2A-M18KS08-M1-B2	E2A-M18KS08-M1-B3
	—	■	16.0 mm	29 (59) mm	PNP <sup>1</sup>	E2A-M18KN16-M1-B1	E2A-M18KN16-M1-B2	E2A-M18KN16-M1-B3
M30	■	—	15.0 mm	44 (64) mm	PNP <sup>1</sup>	E2A-M30KS15-M1-B1	E2A-M30KS15-M1-B2	E2A-M30KS15-M1-B3
	—	■	20.0 mm	29 (64) mm	PNP <sup>1</sup>	E2A-M30KN20-M1-B1	E2A-M30KN20-M1-B2	E2A-M30KN20-M1-B3

<sup>1</sup> NPN models are also available.

<sup>2</sup> Longer housing models.



## DC 2-Wire Inductive Sensor in Cylindrical Brass Housing



The DC 2-wire models of the E2A family are easy to install and allow the detection of cable breakage.





- Extended (double) sensing distance
- IP67 and IP69k for highest protection in wet environments

## DC 2-Wire Sensors, Pre-Wired

(For different cable materials and lengths, special housing length or special connectors, please refer to complete datasheet)

Size			Sensing Distance	Thread Length (overall length)	Model (for pre-wired types with 2 m cable length)	
					Operation Mode NO	Operation Mode NC
M8	■	—	2.0 mm	27 (40) mm	E2A-S08KS02-WP-D1 2M	E2A-S08KS02-WP-D2 2M
	—	■	4.0 mm	21 (40) mm	E2A-S08KN04-WP-D1 2M	E2A-S08KN04-WP-D2 2M
M12	■	—	4.0 mm	34 (50) mm	E2A-M12KS04-WP-D1 2M	E2A-M12KS04-WP-D2 2M
	—	■	8.0 mm	27 (50) mm	E2A-M12KN08-WP-D1 2M	E2A-M12KN08-WP-D2 2M
M18	■	—	8.0 mm	39 (59) mm	E2A-M18KS08-WP-D1 2M	E2A-M18KS08-WP-D2 2M
	—	■	16.0 mm	29 (59) mm	E2A-M18KN16-WP-D1 2M	E2A-M18KN16-WP-D2 2M
M30	■	—	15.0 mm	44 (64) mm	E2A-M30KS15-WP-D1 2M	E2A-M30KS15-WP-D2 2M
	—	■	20.0 mm	29 (64) mm	E2A-M30KN20-WP-D1 2M	E2A-M30KN20-WP-D2 2M

## DC 2-Wire Sensors, Connector Versions (M12)

Size			Sensing Distance	Thread Length (overall length)	Model (for M12 connector types)	
					Operation Mode NO	Operation Mode NC
M8	■	—	2.0 mm	27 (43) mm	E2A-S08KS02-M1G-D1	E2A-S08KS02-M1G-D2
	—	■	4.0 mm	21 (43) mm	E2A-S08KN04-M1G-D1	E2A-S08KN04-M1G-D2
M12	■	—	4.0 mm	34 (48) mm	E2A-M12KS04-M1G-D1	E2A-M12KS04-M1G-D2
	—	■	8.0 mm	27 (48) mm	E2A-M12KN08-M1G-D1	E2A-M12KN08-M1G-D2
M18	■	—	8.0 mm	39 (53) mm	E2A-M18KS08-M1G-D1	E2A-M18KS08-M1G-D2
	—	■	16.0 mm	29 (53) mm	E2A-M18KN16-M1G-D1	E2A-M18KN16-M1G-D2
M30	■	—	15.0 mm	44 (58) mm	E2A-M30KS15-M1G-D1	E2A-M30KS15-M1G-D2
	—	■	20.0 mm	29 (58) mm	E2A-M30KN20-M1G-D1	E2A-M30KN20-M1G-D2

## Extended Range, DC 2-Wire Short Barrel Sensors

- Nickel-Plated Brass (NPB) barrel
- Wrench flats for easy installation
- Solid potted internal circuitry withstands shocks
- IP67 rated, 1200 psi water washdown
- Built-in circuit protection
- Normally Open (NO) circuit type stocked; Normally Closed (NC) available



## DC 2-Wire Sensors, Pre-Wired with 2 m Cable

Size	Sensing Distance (mm)	Shielded	Circuit Type	Response Frequency	Body Material	Thread Length (overall length) mm	Model
M12	4.0	Yes	NO	1 kHz	NPB	33 (38)	E2EM-X4X1
M18	8.0			500 Hz			E2EM-X8X1
	16.0	No		400 Hz		50 (65)	
M30	15.0	Yes		250 Hz		43 (48)	E2EM-X15X1
	30.0	No	100 Hz	50 (70)		E2EM-X30MX1	

## DC 2-Wire with M12 Micro-Change® Connectors

NPN Normally Open (C1-M1)

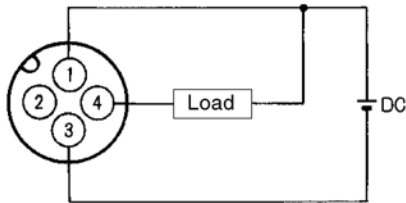

PNP Normally Open (B1-M1)

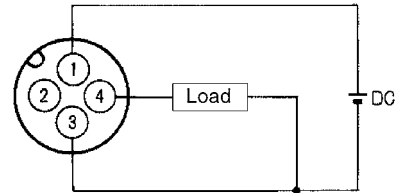

Size	Sensing Distance (mm)	Shielded	Circuit Type	Response Frequency	Body Material	Thread Length (overall length) mm	Model
M8	2.0	Yes	NPN-NO	1.5 kHz	NPB	30 (43)	E2EM-X2C1-M1
			PNP-NO				E2EM-X2B1-M1
M12	4.0		NPN-NO	500 Hz		33 (48)	E2EM-X4C1-M1
			PNP-NO				E2EM-X4B1-M1
M18	8.0		NPN-NO	300 Hz		38 (53)	E2EM-X8C1-M1
			PNP-NO				E2EM-X8B1-M1
M30	15.0		NPN-NO	100 Hz		38 (53)	E2EM-X15C1-M1
			PNP-NO				E2EM-X15B1-M1

## Long (triple) Distance Inductive Sensor in Cylindrical Brass Housing

The E2A3 family features an optimized sensing performance to achieve triple sensing distance for flush mounting requirements.



- Triple distance for enhanced sensor protection from mechanical damage
- IP67 and IP69k

## DC 3-Wire Sensors, Pre-Wired

(For different cable materials and lengths, special housing length or special connectors, please refer to complete datasheet)

Size		Sensing Distance	Thread Length (overall length)	Output Type	Model (for pre-wired types with 2 m cable length)	
					Operation Mode NO	Operation Mode NC
M8	■	3.0 mm	27 (40) mm	PNP	E2A3-S08KS03-WP-B1 2M	E2A3-S08KS03-WP-B2 2M
				NPN	E2A3-S08KS03-WP-C1 2M	E2A3-S08KS03-WP-C2 2M
M12	■	6.0 mm	34 (50) mm	PNP	E2A3-M12KS06-WP-B1 2M	E2A3-M12KS06-WP-B2 2M
				NPN	E2A3-M12KS06-WP-C1 2M	E2A3-M12KS06-WP-C2 2M
M18	■	11.0 mm	39 (60) mm	PNP	E2A3-M18KS11-WP-B1 2M	E2A3-M18KS11-WP-B2 2M
				NPN	E2A3-M18KS11-WP-C1 2M	E2A3-M18KS11-WP-C2 2M
M30	■	20.0 mm	44 (65) mm	PNP	E2A3-M30KS20-WP-B1 2M	E2A3-M30KS20-WP-B2 2M
				NPN	E2A3-M30KS20-WP-C1 2M	E2A3-M30KS20-WP-C2 2M

## DC 3-Wire Sensors, Connector Versions (M12)

Size		Sensing Distance	Connection	Thread Length (overall length)	Output Type	Model (for M12 connector types)	
						Operation Mode NO	Operation Mode NC
M8	■	3.0 mm	M12 Connector	27 (44) mm	PNP	E2A3-S08KS03-M1-B1	E2A3-S08KS03-M1-B2
					NPN	E2A3-S08KS03-M1-C1	E2A3-S08KS03-M1-C2
M12	■	6.0 mm		34 (49) mm	PNP	E2A3-M12KS06-M1-B1	E2A3-M12KS06-M1-B2
					NPN	E2A3-M12KS06-M1-C1	E2A3-M12KS06-M1-C2
M18	■	11.0 mm		39 (54) mm	PNP	E2A3-M18KS11-M1-B1	E2A3-M18KS11-M1-B2
					NPN	E2A3-M18KS11-M1-C1	E2A3-M18KS11-M1-C2
M30	■	20.0 mm		44 (59) mm	PNP	E2A3-M30KS20-M1-B1	E2A3-M30KS20-M1-B2
					NPN	E2A3-M30KS20-M1-C1	E2A3-M30KS20-M1-C2

## Long-Barrel DC 2-Wire Proximity Sensors Reduce Wiring to Control Devices

- Nickel-plated brass (NPB) barrel
- Wrench flats for easy installation
- Solid potted internal circuitry withstands shocks
- IP67 rated, 1200 psi water washdown
- High visibility indicator
- Flush mountable shielded versions
- Built-in circuit protection
- Normally Open (NO) circuit type stocked; Normally Closed (NC) available
- Sensor mounting and protective accessories, see Y92E



## DC 2-Wire Sensors, Pre-Wired with 2 m Cable

Size	Sensing Distance (mm)	Shielded	Circuit Type	Response Frequency	Body Material	Thread Length (overall length) mm	Model
M12	3.0	Yes	NO	1000 Hz	NPB	55 (60)	E2E2-X3D1
			NC				E2E2-X3D2
	8.0	No	NO	800 Hz		48 (60)	E2E2-X8MD1
			NC				E2E2-X8MD2
M18	7.0	Yes	NO	500 Hz		60 (65)	E2E2-X7D1
			NC				E2E2-X7D2
	14.0	No	NO	400 Hz		50 (65)	E2E2-X14MD1
			NC				E2E2-X14MD2
M30	10.0	Yes	NO	100 Hz	65 (70)	E2E2-X10D1	
			NC			E2E2-X10D2	
	20.0	No	NO		52 (70)	E2E2-X20MD1	
			NC			E2E2-X20MD2	

## Long-Barrel DC 3-Wire Proximity Sensors Built for Rugged Duty

- Nickel-plated brass (NPB) barrel
- Wrench flats for easy installation
- Solid potted internal circuitry withstands shocks
- IP67 rated, 1200 psi water washdown
- High visibility indicator
- Voltage output eliminates the need for pull up/down resistors (standard models)
- Flush mountable shielded versions
- Unshielded models offer longest sensing distances
- Built-in circuit and polarity protection
- Normally Open (NO) models stocked; Normally Closed (NC) available
- Sensor mounting and protective accessories, see Y92E



## DC 3-Wire Sensors, Pre-Wired with 2 m Cable

Size	Sensing Distance (mm)	Shielded	Circuit Type	Response Frequency	Body Material	Thread Length (overall length) mm	Model
M12	2.0	Yes	NPN-NO	1.5 kHz	NPB	55 (60)	E2E2-X2C1
			PNP-NO				E2E2-X2B1
	5.0	No	NPN-NO	400 Hz		48 (60)	E2E2-X5MC1
			PNP-NO				E2E2-X5MB1
M18	5.0	Yes	NPN-NO	600 Hz		60 (65)	E2E2-X5C1
			PNP-NO				E2E2-X5B1
	10.0	No	NPN-NO	200 Hz		50 (65)	E2E2-X10MC1
			PNP-NO				E2E2-X10MB1
M30	10.0	Yes	NPN-NO	400 Hz	65 (70)	E2E2-X10C1	
			PNP-NO			E2E2-X10B1	
	18.0	No	NPN-NO	100 Hz	52 (70)	E2E2-X18MC1	
			PNP-NO			E2E2-X18MB1	

## DC 3-Wire Sensors with Built-in M12 Micro-Change® Connectors

NPN Normally Open (C1-M1)

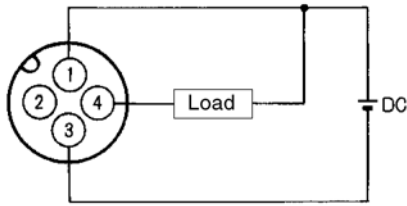

Note: Terminal 2 is not used

PNP Normally Open (B1-M1)

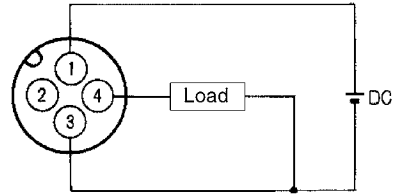

Note: Terminal 2 is not used

Size	Sensing Distance (mm)	Shielded	Circuit Type	Response Frequency	Body Material	Thread Length (overall length) mm	Model
M12	2.0	Yes	NPN-NO	1.5 kHz	NPB	55 (70)	E2E2-X2C1-M1
			PNP-NO				E2E2-X2B1-M1
	5.0	No	NPN-NO	400 Hz		48 (70)	E2E2-X5MC1-M1
			PNP-NO				E2E2-X5MB1-M1
M18	5.0	Yes	NPN-NO	600 Hz		60 (75)	E2E2-X5C1-M1
			PNP-NO				E2E2-X5B1-M1
	10.0	No	NPN-NO	200 Hz		50 (75)	E2E2-X10MC1-M1
			PNP-NO				E2E2-X10MB1-M1
M30	10.0	Yes	NPN-NO	400 Hz	65 (80)	E2E2-X10C1-M1	
			PNP-NO			E2E2-X10B1-M1	
	18.0	No	NPN-NO	100 Hz	52 (80)	E2E2-X18MC1-M1	
			PNP-NO			E2E2-X18MB1-M1	

## Long-Barrel AC 2-Wire Proximity Sensors Built for Rugged Duty

- Nickel-plated brass (NPB) barrel
- Wrench flats for easy installation
- Solid potted internal circuitry withstands shocks
- IP67 rated, 1200 psi water washdown
- High visibility indicator
- Flush mountable shielded versions
- Normally Open (NO) models stocked; Normally Closed (NC) available
- Sensor mounting and protective accessories, see Y92E



## AC 2-Wire Sensors, Pre-Wired with 2 m Cable

Size	Sensing Distance (mm)	Shielded	Circuit Type	Response Frequency	Body Material	Thread Length (overall length) mm	Model
M12	2.0	Yes	NO	25 Hz	NPB	55 (60)	E2E2-X2Y1-US
	5.0	No				48 (60)	E2E2-X5MY1-US
M18		Yes				60 (65)	E2E2-X5Y1-US
	10.0	No				50 (65)	E2E2-X10MY1-US
M30	Yes	65 (70)				E2E2-X10Y1-US	
	18.0	No				52 (70)	E2E2-X18MY1-US

## AC 2-Wire Sensors with M12, 3-Pin Dual Key-Way Micro-Change® Connectors

Normally Open

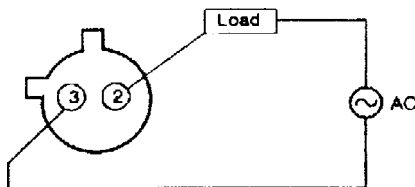

Size	Sensing Distance (mm)	Shielded	Circuit Type	Response Frequency	Body Material	Thread Length (overall length) mm	Model
M12	2.0	Yes	NO	25 Hz	NPB	55 (70)	E2E2-X2Y1-M4
	5.0	No				48 (70)	E2E2-X5MY1-M4
M18		Yes				60 (75)	E2E2-X5Y1-M4
	10.0	No				50 (75)	E2E2-X10MY1-M4
M30	Yes	65 (80)				E2E2-X10Y1-M4	
	18.0	No				52 (80)	E2E2-X18MY1-M4

## Long-Barrel DC 3-Wire Proximity Sensors Built for Rugged Duty

- Longer sensing distance reduces maintenance frequency by avoiding collisions between the work piece and the sensor
- Flush mountable M8 and M12 shielded versions; M18 and M30 versions allow flush mounting with the clearance from the nuts provided
- 360° view of yellow operation indicator
- Built-in circuit protection
- Normally Open (NO) circuit type stocked; Normally Closed (NC) available
- Sensor mounting and protective accessories, see Y92E



## DC 3-Wire Sensors, Pre-Wired with 2 m Cable

Size	Sensing Distance (mm)	Shielded	Circuit Type	Response Frequency	Body Material	Thread Length (overall length) mm	Model
M8	2.0	Yes	PNP-NO	1500 Hz	SUS	49 (62)	E2A-S08LS02-WP-B1-2M
			NPN-NO				E2A-S08LS02-WP-C1-2M
	4.0	No	PNP-NO	1000 Hz			E2A-S08LN04-WP-B1-2M
			NPN-NO				E2A-S08LN04-WP-C1-2M
M12	8.0	No	PNP-NO	800 Hz	NPB	56 (72)	E2A-M12LS04-WP-B1-2M
			NPN-NO				E2A-M12LS04-WP-C1-2M
	4.0	Yes	PNP-NO	1500 Hz			E2A-M12LN08-WP-B1-2M
			NPN-NO				E2A-M12LN08-WP-C1-2M
M18	16.0	No	PNP-NO	400 Hz	61 (81)	61 (81)	E2A-M18LS08-WP-B1-2M
			NPN-NO				E2A-M18LS08-WP-C1-2M
	8.0	Yes	PNP-NO	500 Hz			E2A-M18LN16-WP-B1-2M
			NPN-NO				E2A-M18LN16-WP-C1-2M
M30	15.0	Yes	PNP-NO	250 Hz	66 (86)	66 (86)	E2A-M30LS15-WP-B1-2M
			NPN-NO				E2A-M30LS15-WP-C1-2M
	30.0	No	PNP-NO	100 Hz			E2A-M30LN30-WP-B1-2M
			NPN-NO				E2A-M30LN30-WP-C1-2M



## DC 3-Wire Sensors, M12 Connector

Size	Sensing Distance (mm)	Shielded	Circuit Type	Response Frequency	Body Material	Thread Length (overall length) mm	Model
M8	2.0	Yes	PNP-NO	1500 Hz	SUS	49 (65)	E2A-S08LS02-M1-B1
			NPN-NO				NPB
			PNP-NO		E2A-M08LS02-M1-B1		
			NPN-NO		E2A-M08LS02-M1-C1		
	4.0	No	PNP-NO	1000 Hz	SUS		E2A-S08LN04-M1-B1
			NPN-NO		NPB		E2A-S08LN04-M1-C1
			PNP-NO				E2A-M08LN04-M1-B1
			NPN-NO				E2A-M08LN04-M1-C1
M12	8.0	No	PNP-NO	800 Hz		61 (75)	E2A-M12LS04-M1-B1
			NPN-NO		E2A-M12LS04-M1-C1		
	Yes	PNP-NO	500 Hz	E2A-M12LN08-M1-B1			
		NPN-NO		E2A-M12LN08-M1-C1			
M18	16.0	No	PNP-NO	400 Hz	66 (80)		E2A-M18LS08-M1-B1
			NPN-NO				E2A-M18LS08-M1-C1
	Yes	PNP-NO	250 Hz	E2A-M18LN16-M1-B1			
		NPN-NO		E2A-M18LN16-M1-C1			
M30	15.0	Yes	PNP-NO	250 Hz	66 (80)	E2A-M30LS15-M1-B1	
			NPN-NO			E2A-M30LS15-M1-C1	
	30.0	No	PNP-NO	100 Hz		E2A-M30LN30-M1-B1	
			NPN-NO			E2A-M30LN30-M1-C1	

## DC 3-Wire Inductive Sensor for Vehicle-Mounted Machinery

Extended sensing distance sensors in durable brass housing are waterproof and rated for use on mobile machines.

- Extended (double) sensing distance
- IP67 and IP69k for highest protection in wet environments
- Low electromagnetic noise for use on machinery mounted to a vehicle, such as harvesters, balers, and robotic arms
- EMC noise tested up to 100 V/m (ISO 11452-2)
- e1 type approval (according to automotive directive 95/54/EC)



## DC 3-Wire Sensors, Pre-wired

(For different cable materials and lengths, special housing length or special connectors, please refer to complete datasheet)

Size		Sensing Distance	Output Type	Model (for pre-wired types with 2m cable length)	
				Operation Mode NO	
M12	■	4.0 mm	PNP	E2AU-M12KS04-WP-B1 2M	
			PNP	E2AU-M12LS04-WP-B1 2M	
M18	■	8.0 mm	PNP	E2AU-M18KS08-WP-B1 2M	
			PNP	E2AU-M18LS08-WP-B1 2M	
M30	■	15.0 mm	PNP	E2AU-M30KS15-WP-B1 2M	
			PNP	E2AU-M30LS15-WP-B1 2M	

## DC 3-Wire Sensors, Connector Versions (M12)



Size		Sensing Distance	Output Type	Model (for M12 connector types)	
				Operation Mode NO	
M12	■	4.0 mm	PNP	E2AU-M12KS04-M1-B1	
			PNP	E2AU-M12LS04-M1-B1	
M18	■	8.0 mm	PNP	E2AU-M18KS08-M1-B1	
			PNP	E2AU-M18LS08-M1-B1	
M30	■	15.0 mm	PNP	E2AU-M30KS15-M1-B1	
			PNP	E2AU-M30LS15-M1-B1	

## Subminiature Sensor with In-line Amplifier Offers Great Mounting Flexibility

- Small nickel-plated brass (NPB) sensing heads on 0.4 m cable fit space-confined installations
- Shielded sensing head allows the sensor to be flush mounted in metal
- Easy operation monitoring with LED indicator on the amplifier unit
- Robotic cable on DC 2-wire models withstands repeated flexing on robots and reciprocating machinery
- DC 2-wire models have cylindrical amplifiers; DC 3-wire rectangular amplifiers allow side-by-side mounting
- Normally Open (NO) circuit type stocked; Normally Closed (NC) available
- Rated IP67 (2-wire); IP64 (3-wire)



### DC 2-Wire Sensors

Size	Sensing Distance (mm)	Shielded	Circuit Type	Response Frequency	Body Material	Thread Length (overall length) mm	Model
3 mm dia.	0.8	Yes	NO	1.5 kHz	NPB	0 (12)	E2EC-CR8D1
			NC				E2EC-CR8D2
5.4 mm dia.	1.5		NO	1 kHz		0 (18)	E2EC-C1R5D1
			NC				E2EC-C1R5D2
8 mm dia.	3		NO	1 kHz		18 (23.6)	E2EC-C3D1
			NC				E2EC-C3D2
M12	4		NO	1 kHz		18 (23.6)	E2EC-X4D1
			NC				E2EC-X4D2

### DC 3-Wire Sensors

Size	Sensing Distance (mm)	Shielded	Circuit Type	Response Frequency	Body Material	Thread Length (overall length) mm	Model
3 mm dia.	0.5	Yes	NPN-NO	1 kHz	NPB	0 (12)	E2EC-CR5C1
8 mm dia.	2.5					0 (18)	E2EC-C2R5C1

### Accessories

Description		Model
Mounting brackets	Fits 5.4 mm dia. E2EC-C1R5D sensors, SUS304 strap	Y92E-F5R4
	Fits M12 size E2EC-X4D@ sensors	Y92E-B12

## Subminiature, Flat-Pack DC Sensor Fits Tight Spaces

- Rated IP67 for water washdown
- Space-saving mounting area, as small as 10 x 27 mm (0.39 x 1.06 in), is ideal for conveyor wall mounting
- Mounts directly onto metal base or rail
- Rugged die-cast metal or heat-resistant ABS plastic housing
- Pre-wired with 2 m (6.56 ft) length cable
- Built-in circuit protection
- DC 2-wire and DC 3-wire models



## DC 2-Wire Flat-Pack Inductive Sensors

Sensing distance (mm)	Shielded	Circuit Type	Response Frequency	Body material	Dimensions	Model
5	NO	NPN-NO	500 Hz	ABS	30.5 x 18 x 10	TL-W5MD1
		NON-NC				TL-W5MD2

## DC 3-Wire Flat-Pack Inductive Sensors

Sensing Distance (mm)	Shielded	Circuit Type	Response Frequency	Body Material	Dimensions	Model
1.5	No	NPN-NO	1 kHz	ABS	25 x 8 x 5.5	TL-W1R5MC1*
3			NPN-NC		600 Hz	27 x 10 x 6
		5			NPN-NO	500 Hz
NPN-NC			Diecast aluminum			
	Yes	NPN-NO		300 Hz	TL-W5E1	
NPN-NC			TL-W5E2			
		NPN-NO	TL-W5F1			
NPN-NC			TL-W5F2			
	20	No	NPN-NO	40 Hz	ABS	53 x 40 x 23
NPN-NC			TL-W20MF1			

\* Model includes mounting bracket.

## Long Distance Inductive Sensor in Short Plastic Body

- M12 Plug-in connection
- Integrated short circuit and reverse polarity protection
- Active face positioning:  
Y-axis 15°, X-axis 90° increments



### DC Models

Sensing Distance (mm)	Connection	Active Face	Model		
			Type	NO	NO+NC
20 mm shielded	Plug-in Connector	Changeable	NPN	E2Q5-N20E1-M1	E2Q5-N20E3-M1
			PNP	E2Q5-N20F1-M1	E2Q5-N20F3-M1
40 mm non-shielded			NPN	E2Q5-N40ME1-M1	E2Q5-N40ME3-M1
			PNP	E2Q5-N40MF1-M1	E2Q5-N40MF3-M1

## World's Smallest Square Sensor with Built-In Amplifier

- 5.5 x 5.5 mm type allows smaller, space-saving machines and devices
- High response frequency (1 kHz) for fast machine processes
- Long sensing distance: (E2S-91, 1.6 mm) (E2S-92, 2.5 mm)
- Front and end sensing face versions match mounting needs
- DC 2-wire and DC 3-wire models
- Pre-wired with 3 m cable
- Rated IP67 for water washdown



## Threaded, Cylindrical Sensor Detects Metallic and Non-Metallic Objects

- Non-contact detection of metallic and non-metallic targets including water, oil, glass, plastic and wood
- Detects level inside non-metallic containers
- Built-in amplifier switches loads up to 200 mA
- LED indicator and fixed sensitivity for simple installation
- Built-in circuit protection
- Heat-resistant ABS plastic sensor rated IP66



- Normally Open (NO) and Normally Closed (NC) available
- CE (all models), UL, CSA (AC models)
- Sensor mounting and protective accessories, see Y92E

### DC 3-Wire Models

Size	Sensing Distance (mm)	Shielded	Circuit Type	Response Frequency	Body Material	Thread Length (overall length) mm	Model
M12	4.0	NO	NPN-NO	100 Hz	ABS	40 (80)	E2K-X4ME1
			NPN-NC				E2K-X4ME2
			PNP-NO				E2K-X4MF1
			PNP-NC				E2K-X4MF2
M18	8.0	NO	NPN-NO	100 Hz	ABS	40 (80)	E2K-X8ME1
			NPN-NC				E2K-X8ME2
			PNP-NO				E2K-X8MF1
			PNP-NC				E2K-X8MF2
M30	15.0	NO	NPN-NO	100 Hz	ABS	50 (80)	E2K-X15ME1
			NPN-NC			E2K-X15ME2	
			PNP-NO			E2K-X15MF1	
			PNP-NC			E2K-X15MF2	

### AC 2-Wire Models

Size	Sensing Distance (mm)	Shielded	Circuit Type	Response Frequency	Body Material	Thread Length (overall length) mm	Model
M12	4.0	NO	SCR-NO	10 Hz	ABS	40 (80)	E2K-X4MY1
			SCR-NC				E2K-X4MY2
M18	8.0	NO	SCR-NO	10 Hz	ABS	40 (80)	E2K-X8MY1
			SCR-NC				E2K-X8MY2
M30	15.0	NO	SCR-NO	10 Hz	ABS	50 (80)	E2K-X15MY1
			SCR-NC			E2K-X15MY2	

## Cylindrical Sensor Offers Adjustable Detecting Distance

- Non-contact detection of metallic and non-metallic targets including water, oil, glass, plastic and wood
- Detects level inside non-metallic containers
- Settable detection distance from 3 to 25 mm with multi-turn adjuster
- Reliably detects foamy liquids in sight glass applications
- Built-in amplifier switches up to 200 mA
- Mounting bracket included
- AC 2-wire and DC 3-wire models available
- Heat-resistant ABS plastic sensor rated IP66

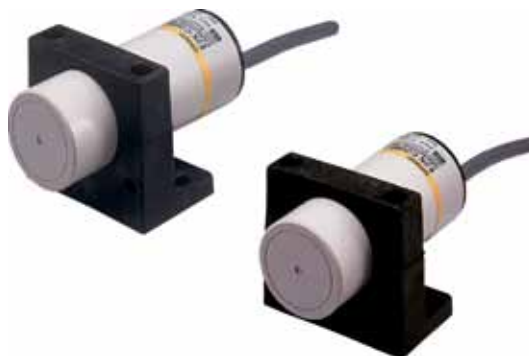

- Normally Open (NO) and Normally Closed (NC) available
- CE (all models), UL, CSA (AC models)

## DC 3-Wire Sensors

Size (dia.)	Sensing Distance (mm)	Shielded	Circuit Type	Response Frequency	Body Material	Thread Length (overall length) mm	Model
34 mm	3 to 25	No	NPN-NO	70 Hz	ABS	0 (89)	E2K-C25ME1
			NPN-NC				E2K-C25ME2
			PNP-NO				E2K-C25MF1
			PNP-NC				E2K-C25MF2

## AC 2-Wire Sensors

Size (dia.)	Sensing Distance (mm)	Shielded	Circuit Type	Response Frequency	Body Material	Thread Length (overall length) mm	Model
34 mm	3 to 25	No	SCR-NO	10 Hz	ABS	0 (89)	E2K-C25MY1
			SCR-NC				E2K-C25MY2

## Accessories

Barrel size	Description	Model
M30 (34 mm)	Sight Glass Mount for M30 (34 mm) Barrel Proximity Sensor	Y92E-SGM34

## Thin Rectangular Plastic DC 3-Wire Sensor Fits Tight Spaces

- Non-contact detection of metallic and non-metallic targets including water, oil, glass, plastic and wood
- Detects level inside non-metallic containers
- Thin, 10 mm (0.39 inch) body is ideal for conveyor wall mounting
- Unshielded sensor has LED indicator and fixed sensitivity for simple installation
- Built-in amplifier provides NPN switching of loads to 100 mA



- Heat-resistant ABS plastic body rated IP66

## Flat-Pack Capacitive Sensors

Sensing Distance (mm)	Shielded	Circuit Type	Response Frequency	Body Material	Dimensions (H x W x D) mm	Model
10	No	NPN-NO	100 Hz	ABS	20.5 x 50 x 10.1	E2K-F10MC1
		NPN-NC				E2K-F10MC2
4-10		NPN-NO				E2K-F10MC1-A
		NPN-NC				E2K-F10MC2-A

## Capacitive Liquid Level Sensor

- Mounts directly to sight glass and bypass pipes
- Sensors unaffected by liquid color
- Fits a wide range of pipe diameters: 8 to 11 mm or 12 to 26 mm
- Built-in amplifier with indicator and sensitivity adjuster
- Sensing heads rated IP66





## Watertight and Chemical-Resistant Short Barrel, Plastic Body Sensors

- IP68 watertight construction
- Polyarylate plastic housing offers good chemical resistance to acids and solvents
- Operation indicator on all models
- Short-circuit protection available on all DC and some AC models
- CE all models; UL and CSA (M18, M30 AC 2-wire)



- Sensor mounting and protective accessories, see Y92E

## DC 3-Wire Models

Size	Sensing Distance (mm)	Shielded	Circuit Type	Response Frequency	Body Material	Thread Length (overall length) mm	Model
M8	1.5	Yes	NPN-NO	2 kHz	Polyarylate	20 (30)	E2F-X1R5E1
			NPN-NC				E2F-X1R5E2
			PNP-NO				E2F-X1R5F1
			PNP-NC				E2F-X1R5F2
M12	2.0	Yes	NPN-NO	1.5 kHz	Polyarylate	24 (38)	E2F-X2E1
			NPN-NC				E2F-X2E2
			PNP-NO				E2F-X2F1
			PNP-NC				E2F-X2F2
M18	5.0	Yes	NPN-NO	600 Hz	Polyarylate	29 (47)	E2F-X5E1
			NPN-NC				E2F-X5E2
			PNP-NO				E2F-X5F1
			PNP-NC				E2F-X5F2
M30	10.0	Yes	NPN-NO	400 Hz	Polyarylate	38 (57)	E2F-X10E1
			NPN-NC				E2F-X10E2
			PNP-NO				E2F-X10F1
			PNP-NC				E2F-X10F2

## AC 2-Wire Sensors

### Without Short-Circuit Protection

Size	Sensing Distance (mm)	Shielded	Circuit Type	Response Frequency	Body Material	Thread Length (overall length) mm	Model
M8	1.5	Yes	SCR-NO	25 Hz	Polyarylate	29 (40)	E2F-X1R5Y1
			SCR-NC				E2F-X1R5Y2
M12	2.0	Yes	SCR-NO	25 kHz	Polyarylate	29 (43)	E2F-X2Y1
			SCR-NC				E2F-X2Y2
M18	5.0	Yes	SCR-NO	25 Hz	Polyarylate	29 (47)	E2F-X5Y1-US
			SCR-NC				E2F-X5Y2-US
M30	10.0	Yes	SCR-NO	25 Hz	Polyarylate	38 (57)	E2F-X10Y1-US
			SCR-NC				E2F-X10Y2-US

## All-Stainless Inductive Sensor Resists Abrasion and Chemicals

- One-piece 303 stainless steel face/barrel construction resists damage caused by work piece contact, scouring abrasion, and harsh chemicals
- Up to 0.8 mm thick sensing face for superior mechanical durability, wear resistance
- Operation not influenced by accumulation of aluminum or iron cutting chips and weld slag
- 20% longer sensing range (10 mm) with M30 models versus the CENELEC standard 8 mm
- Flush mountable in ferrous materials to protect sensor from side impact damage



- Thick insulation protects pig-tail lead for increased endurance in harsh environments
- IP67 enclosure rating

## DC 3-Wire Sensors, Pre-Wired with 2 m Cable

Size	Sensing Distance (mm)	Shielded	Output Type	Response Frequency	Thread Length (overall length) mm	Model
M8	1.5	Yes	PNP-NO	200 Hz	25 (49)	E2FM-X1R5B1
			NPN-NO			E2FM-X1R5C1
M12	2.0		PNP-NO	100 Hz	33 (53)	E2FM-X2B1
			NPN-NO			E2FM-X2C1
M18	5.0		PNP-NO	50 Hz	36 (56)	E2FM-X5B1
			NPN-NO			E2FM-X5C1
M30	10.0		PNP-NO	50 Hz	43 (63.5)	E2FM-X10B1
			NPN-NO			E2FM-X10C1

## DC 3-Wire Sensors, Built-in M12 Connector

Size	Sensing Distance (mm)	Shielded	Circuit Type	Response Frequency	Thread Length (overall length) mm	Model	
M8	1.5	Yes	PNP-NO	200 Hz	25 (53.5)	E2FM-X1R5B1-M1	
			NPN-NO			E2FM-X1R5C1-M1	
M12	2.0		PNP-NO	100 Hz	33 (53)	E2FM-X2B1-M1	
			NPN-NO			E2FM-X2C1-M1	
M18	5.0		PNP-NO			36 (56)	E2FM-X5B1-M1
			NPN-NO				E2FM-X5C1-M1
M30	10.0	PNP-NO	50 Hz	43 (63.5)	E2FM-X10B1-M1		
		NPN-NO			E2FM-X10C1-M1		

## DC 2-Wire Sensors, Pre-Wired with 2 m Cable

Size	Sensing Distance (mm)	Shielded	Circuit Type	Response Frequency	Thread Length (overall length) mm	Model	
						Standard	with Fluoresin Coating
M8	1.5	Yes	NO, polarity	200 Hz	25 (49)	E2FM-X1R5D1	E2FM-QX1R5D1
M12	2.0			100 Hz	33 (53)	E2FM-X2D1	E2FM-QX2D1
M18	5.0		NO, polarity	36 (56)	E2FM-X5D1	E2FM-QX5D1	
M30	10.0		NO, polarity	50 Hz	43 (63.5)	E2FM-X10D1	E2FM-QX10D1



E2FM extra strong sensing face



No interference by small metal chips on sensing surface

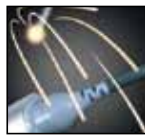

Cable resistant to welding spatter



## Heat and Detergent Resistant Inductive Sensor in Cylindrical Stainless Steel Housing

The heat and detergent resistant inductive sensors allow reliable metal object or machine part detection in demanding environments such as food processing.





- Temperature resistant up to 120°C
- SUS316L housing with heat resistant plastic sensing face
- P69k for highest water resistance
- ECOLAB tested and certified detergent resistance

### DC 3-Wire and DC 2-Wire Sensors, Pre-Wired

Size		Sensing Distance	Output Type	Model (for pre-wired types with 2 m cable length)	
				Operation Mode NO	Operation Mode NC
M12		3 mm	PNP	E2EH-X3B1 2M	E2EH-X3B2 2M
			NPN	E2EH-X3C1 2M	E2EH-X3C2 2M
			DC 2-wire	E2EH-X3D1 2M	E2EH-X3D2 2M
M18		7 mm	PNP	E2EH-X7B1 2M	E2EH-X7B2 2M
			NPN	E2EH-X7C1 2M	E2EH-X7C2 2M
			DC 2-wire	E2EH-X7D1 2M	E2EH-X7D2 2M
M30		12 mm	PNP	E2EH-X12B1 2M	E2EH-X12B2 2M
			NPN	E2EH-X12C1 2M	E2EH-X12C2 2M
			DC 2-wire	E2EH-X12D1 2M	E2EH-X12D2 2M

### DC 3-Wire and DC 2-Wire Sensors, Connector versions (M12)



Size		Sensing Distance	Output Type	Model (for pre-wired types with 2 m cable length)	
				Operation Mode NO	Operation Mode NC
M12		3 mm	PNP	E2EH-X3B1-M1	E2EH-X3B2-M1
			NPN	E2EH-X3C1-M1	E2EH-X3C2-M1
			DC 2-wire	E2EH-X3D1-M1G	E2EH-X3D2-M1G
M18		7 mm	PNP	E2EH-X7B1-M1	E2EH-X7B2-M1
			NPN	E2EH-X7C1-M1	E2EH-X7C2-M1
			DC 2-wire	E2EH-X7D1-M1G	E2EH-X7D2-M1G
M30		12 mm	PNP	E2EH-X12B1-M1	E2EH-X12B2-M1
			NPN	E2EH-X12C1-M1	E2EH-X12C2-M1
			DC 2-wire	E2EH-X12D1-M1G	E2EH-X12D2-M1G

## Weld-Spatter Resistant DC 2-Wire Cylindrical Sensors

- Rugged fluoroplastic-coated brass barrel withstands high tightening torque
- Fluoroplastic resin face prevents weld slag build-up on sensor
- Stability and operation indicators standard
- Pre-wired and pig-tail connector models



### Pre-Wired with 2 m Cable

Size	Sensing Distance (mm)	Shielded	Output Type	Response Frequency	Body Material	Thread Length (overall length) mm	Model
M12	4.0	Yes	NO	1.0 kHz	Fluoroplastic resin coated brass	33 (38)	E2EQ-X4X1
M18	8.0			500 Hz		38 (43)	E2EQ-X8X1
M30	15.0			250 Hz		43 (48)	E2EQ-X15X1

### M12 Connector on 300 mm Pigtail Lead

Size	Sensing Distance (mm)	Shielded	Output Type	Response Frequency	Body Material	Thread Length (overall length) mm	Model
M12	4.0	Yes	NO	1.0 kHz	Fluoroplastic resin coated brass	33 (38)	E2EQ-X4X1-M1J
M18	8.0			500 Hz		38 (43)	E2EQ-X8X1-M1J
M30	15.0			250 Hz		43 (48)	E2EQ-X15X1-M1J

# E2KQ-X Proximity Sensors

Quick Link  
A327

## Chemical Resistant Capacitive Sensor

- Complete fluoroplastic resin coating for superior chemical and oil resistance
- Detect ferrous and non-ferrous metals as well as other materials
- Adjustable sensitivity from 6 to 10 mm
- Built-in indicator located on cable connection face
- Rated IP66



CE

# E2FQ Proximity Sensors

Quick Link  
A246

## Chemical Resistant Inductive Sensor in Cylindrical PTFE Housing

The E2FQ features a full-body fluoroplastic housing for chemical resistance (e.g. against cleaning agents used in the semiconductor industry).

- Full body fluoroplastic housing for chemical resistance
- DC 2-wire and DC 3-wire models



CE

### DC 2-Wire, Pre-Wired

Size		Sensing Distance	Output Type	Model (for pre-wired types with 2 m cable length)
				Operation Mode NO
M12	■	2 mm	DC 2-wire with polarity	E2FQ-X2D1
M18		5 mm		E2FQ-X5D1
M30		10 mm		E2FQ-X10D1

### DC 3-Wire, Pre-Wired

Size		Sensing Distance	Output Type	Model (for pre-wired types with 2 m cable length)
				Operation Mode NO
M12	■	2 mm	PNP	E2FQ-X2F1
			NPN	E2FQ-X2E1
M18	■	5 mm	PNP	E2FQ-X5F1
			NPN	E2FQ-X5E1
M30	■	10 mm	PNP	E2FQ-X10F1
			NPN	E2FQ-X10E1





## High Precision Positioning Inductive Proximity Sensor with Separate Amplifier

The separate amplifier inductive sensor family E2C-EDA offers high precision distance positioning and detection. The teach-in function allows simple installation, and with the window function (2 outputs) production tolerance checks can easily be set up and modified.



- Typically several hundred  $\mu\text{m}$  detection precision
- Precision distance teaching
- Window function (2 outputs) for production tolerance checks

### Sensor Heads

Appearance				Sensing Distance	Repeat Accuracy	Model
	3 dia. x 18			0.6 mm	1 $\mu\text{m}$	E2C-EDR6-F
	5.4 dia. x 18			1 mm	1 $\mu\text{m}$	E2C-ED01 <sup>1</sup>
	8 dia. x 22			2 mm	2 $\mu\text{m}$	E2C-ED02 <sup>1</sup>
Screw	M10 x 22			2 mm	2 $\mu\text{m}$	E2C-EM02 <sup>1</sup>
Flat	30 x 14 x 4.8			5 mm	2 $\mu\text{m}$	E2C-EV05 <sup>1</sup>
Screw	M18 x x 6.3			7 mm	5 $\mu\text{m}$	E2C-EM07M <sup>1</sup>
Screw (heat resistant)	M12 x 22	2 mm	2 $\mu\text{m}$	E2C-EM02H		

<sup>1</sup> For models with cut-to-length cables add '-F' for example E2C-ED01-F  
For models with protective stainless steel spiral tubes add '-S' for example E2C-ED01-S

### Amplifier Units with Cables

Item	Sensing Distance	Model	
		NPN Output	PNP Output
Twin-output models	Area output, open circuit detection, Differential operation	E2C-EDA11	E2C-EDA41
External-input models	Remote setting, Differential operation	E2C-EDA21	E2C-EDA51

### Amplifier Units with Connector<sup>\*2</sup>

Item	Sensing Distance	Model	
		NPN Output	PNP Output
Twin-output models	Area output, open circuit detection, Differential operation	E2C-EDA6	E2C-EDA8
External-input models	Remote setting, Differential operation	E2C-EDA7	E2C-EDA9

<sup>\*2</sup> Order connector E3X-CN21 separately. See E3X-DA-S in Fiber-Optic Sensors for details.

## Inductive Sensor Detects All Metals at Equal Distance

- One sensor detects all kinds of metal at equal distance
- Detect aluminum up to 3x conventional sensing distance
- Shielded for flush mounting in metal
- Sensing distance: 2 mm (M12); 5 mm (M18); 10 mm (M30)
- Rated IP67, resists water splash and oil contamination



## Inductive Sensor Detects Aluminum in Tight Spaces

- Compact sensing heads and separate amplifier for mounting flexibility
- Detect differences between object types, object position, distance within a range
- Monitor operation with excess gain level bar graph indicator and diagnostic output
- One-touch teaching for sensitivity adjustment
- Shielded for flush mounting in metal
- Sensing distance by sensing head:
  - 1.5 mm (M5 and unthreaded 5.4 mm dia.)
  - 2 mm (unthreaded 8 mm dia.)
  - 3 mm (flat)
- Pre-wired sensing heads and amplifier each with 2 m cable
- Sensing heads rated IP67





## Inductive Sensor for Aluminum and Non-Ferrous Metals

- Detects non-magnetic ones such as aluminum, copper and brass and ignores ferrous materials
- Shielded for flush mounting in metal
- Sensing distance: 4 mm (M18) and 8 mm (M30)
- Rated IP67, resists water splash and oil contamination



# E2EZ Proximity Sensors

## Cutting Chip Resistant Inductive Sensor

- Detects objects without influence of accumulated aluminum and cast iron cutting chips
- Ideal for machine tool applications
- Sensing distance: 4 mm (M18) and 8 mm (M30)
- Shielded for flush mounting in metal
- DC 2-wire, DC 3-wire and AC 2-wire models
- Rated IP67, resists water splash and oil contamination



## Water- and Environment-Resistant M12 Connectors Save Wiring and Maintenance Effort

- Single-ended cables with M12 connectors satisfy IP67 requirements and ensure a 94V-0 fire retardant rating.
- Connectors make wiring a system more modular, simplify maintenance, and reduce downtime.
- Connectors with Cables and Connector Assemblies are available.



## XS2F - M12 Single-ended Cable with Socket

XS2F-M12PVC□□□□M PVC Cable

XS2F-M12PUR□□□□M PUR Cable

### Dimensions

#### Straight

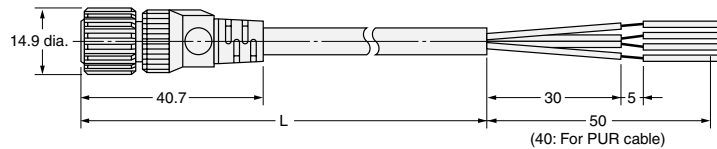
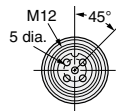
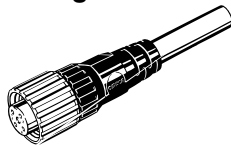

#### Angled

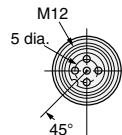
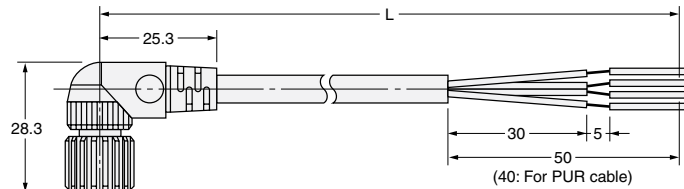

3 cores	4 cores	5 cores

Connector	Size	Cores	Shape	Length (m)	PVC Cable Model	PUR Cable Model
Socket	M12	3	Angled	2	XS2F-M12PVC3A2M	XS2F-M12PUR3A2M
				5	XS2F-M12PVC3A5M	XS2F-M12PUR3A5M
				10	XS2F-M12PVC3A10M	XS2F-M12PUR3A10M
			Straight	2	XS2F-M12PVC3S2M	XS2F-M12PUR3S2M
				5	XS2F-M12PVC3S5M	XS2F-M12PUR3S5M
				10	XS2F-M12PVC3S10M	XS2F-M12PUR3S10M
		4	Angled	2	XS2F-M12PVC4A2M	XS2F-M12PUR4A2M
				5	XS2F-M12PVC4A5M	XS2F-M12PUR4A5M
				10	XS2F-M12PVC4A10M	XS2F-M12PUR4A10M
			Straight	2	XS2F-M12PVC4S2M	XS2F-M12PUR4S2M
				5	XS2F-M12PVC4S5M	XS2F-M12PUR4S5M
				10	XS2F-M12PVC4S10M	XS2F-M12PUR4S10M
		5	Angled	2	XS2F-M12PVC5A2M	XS2F-M12PUR5A2M
				5	XS2F-M12PVC5A5M	XS2F-M12PUR5A5M
			Straight	2	XS2F-M12PVC5S2M	XS2F-M12PUR5S2M
5	XS2F-M12PVC5S5M	XS2F-M12PUR5S5M				

## Extension Cordsets, Two Single Key Molded M12 Sensor Connectors

Description				Model	
Connector Type	Keyway	Cable Size	Length	Straight Connector	Right Angle Connector
4-wire DC female socket and male plug	Single	22 AWG	2 m (6.56 ft)	XS2W-D421-D81-F	—
			5 m (16.40 ft)	XS2W-D421-G81-F	

## Plug and Socket Connector Assemblies for Custom Length Cordsets

Description				Model	
Connector Type	Keyway	Cable Size	Length	Straight Connector	
M12 male plug	Single	2 to 6 mm dia	58.7 mm	XS2G-D4S1	
M12 female socket			54.9 mm	XS2C-D4S1	

## Compact, Watertight M8 Connectors

- Water-resistant, compact connector meets IP67 requirements.
- Using connectors for wiring ensures ease of equipment maintenance and reduces downtime required for equipment maintenance.

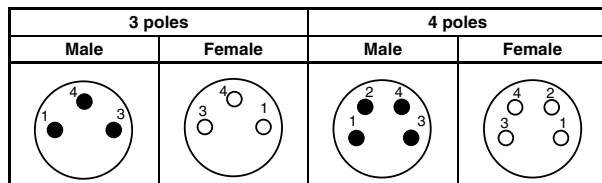

## Connectors with Cable Attached XS3F - M8 Socket on One Cable End

XS3F-M8PVC□□□□M PVC Cable  
XS3F-M8PUR□□□□M PUR Cable

### Dimensions

(Unit: mm)

#### Straight

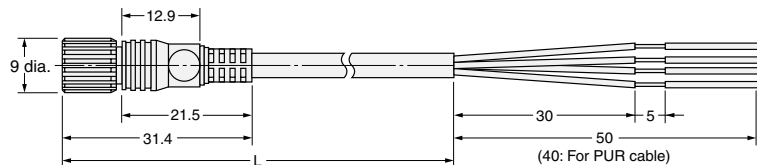

#### Angled

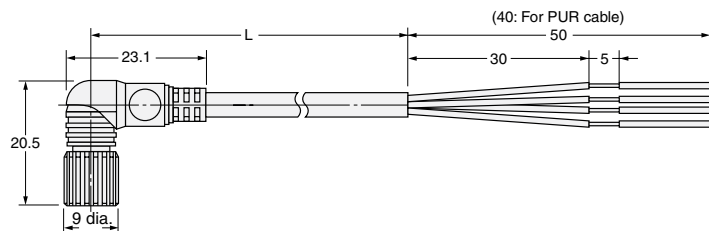

### Wiring Diagram

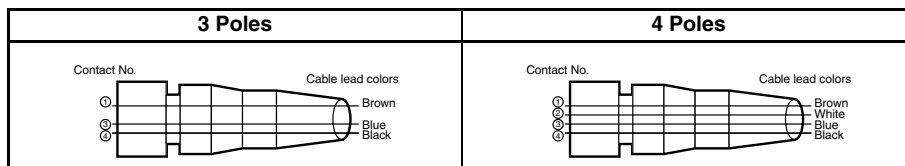

Connector	Size	Cable Material	Poles	Type	Length	Model
Socket	M8	PVC	3	Angled	2	XS3F-M8PVC3A2M
					5	XS3F-M8PVC3A5M
					10	XS3F-M8PVC3A10M
				Straight	2	XS3F-M8PVC3S2M
					5	XS3F-M8PVC3S5M
					10	XS3F-M8PVC3S10M
			4	Angled	2	XS3F-M8PVC4A2M
					5	XS3F-M8PVC4A5M
					10	XS3F-M8PVC4A10M
				Straight	2	XS3F-M8PVC4S2M
					5	XS3F-M8PVC4S5M
					10	XS3F-M8PVC4S10M
		PUR	3	Angled	2	XS3F-M8PUR3A2M
					5	XS3F-M8PUR3A5M
					10	XS3F-M8PUR3A10M
				Straight	2	XS3F-M8PUR3S2M
					5	XS3F-M8PUR3S5M
					10	XS3F-M8PUR3S10M
			4	Angled	2	XS3F-M8PUR4A2M
					5	XS3F-M8PUR4A5M
					10	XS3F-M8PUR4A10M
				Straight	2	XS3F-M8PUR4S2M
					5	XS3F-M8PUR4S5M
					10	XS3F-M8PUR4S10M

## Extension Cordsets, Two Single Key Molded M8 Sensor Connectors

Description					Model
Connector Type	Keyway	Cable Size	Cable Type	Length	Straight Connector
4-wire DC female socket and male plug	Single	22 AWG	Robotic	1 m (3.28 ft)	XS3W-M421-401-R
				2 m (6.56 ft)	XS3W-M421-402-R

## Contents

<b>Selection Guide</b>		I-ii
<b>Photoelectric Sensors</b>		
<b>E3Z</b>	General purpose sensor in compact plastic housing	I-1
<b>E3Z-L</b>	LASER sensor in compact plastic housing	I-2
<b>E3ZM</b>	Detergent resistant photoelectric sensor in compact stainless steel housing	I-3
<b>E3ZM-C</b>	Oil-resistant photoelectric sensor in compact stainless steel housing	I-4
<b>E3ZM-V</b>	Print mark detection photoelectric sensor in compact stainless steel housing	I-5
<b>E3ZM-B</b>	Transparent PET plastic bottle detection sensor in compact stainless steel housing	I-6
<b>E3Z-B</b>	Transparent bottle detection photoelectric sensor in compact plastic housing	I-7
<b>E3Z-G</b>	Photoelectric sensor in plastic fork shape housing	I-7
<b>E3Z-L</b>	Narrow-beam sensor detects small objects	I-8
<b>E3Z-LS</b>	Miniature distance settable sensors with built-in amplifiers	I-9
<b>E3Z-K</b>	Oil-resistant sensors	I-10
<b>E3FZ/ E3FR</b>	Easy mounting photoelectric sensor in plastic M18 housing	I-11
<b>E3F2</b>	Photoelectric sensor in plastic or brass M18 housing	I-12
<b>E3F2- _S</b>	Photoelectric sensor in stainless steel M18 housing	I-13

<b>E3F2- _41</b>	Photoelectric sensor in plastic or brass radial M18 housing	I-14
<b>E3S-CL</b>	Distance-settable photoelectric sensor in metal housing	I-15
<b>E3G</b>	Long distance photoelectric sensor in plastic housing	I-15
<b>E3JK</b>	All voltage (AC/DC) photoelectric sensor in plastic housing	I-16
<b>E3JM</b>	All voltage (AC/DC) photoelectric sensor, terminal block connection	I-17
<b>E3G-M</b>	Long distance all voltage (AC/DC) photoelectric sensor	I-17
<b>E3S- LS3</b>	Photoelectric sensor for structured object detection in plastic housing	I-18
<b>E3T</b>	Photoelectric sensor in miniature plastic housing	I-19
<b>E3S-A</b>	High performance small DC sensors	I-20
<b>E3K</b>	Universal AC/DC sensors	I-20
<b>F3UV</b>	UV power monitor for sterilizing and curing operations	I-21
<b>E3S-C</b>	Oil resistant, long distance sensors	I-22
<b>E39-L</b>	Mounting bracket	I-23
<b>E39-R</b>	Reflectors	I-23

## FOR MACHINES THAT NEVER STOP

Omron Automation and Safety's photoelectric sensor range is designed and tested to achieve the maximum levels of reliability and detection performance. Utilizing the latest sensor technology, our sensors ensure your machines never stop.



Through-beam

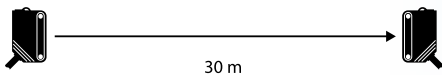

Retroreflective with MSR (Mirror Surface Rejection)

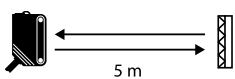

MSR (Mirror Surface Rejection) is a function of Retroreflective Photoelectric Sensors to receive only the light reflected from the Retroreflector by using the characteristics of the polarizing filter built into the Sensor and the characteristics of the Retroreflector.

Diffuse-reflective

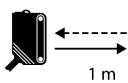

Distance-settable with background suppression



### Compact square plastic housing

#### E3Z



- Highest water resistance
- Highest electromagnetic noise immunity (e.g. from inverters)
- Pulse synchronization for reliable ambient light immunity

### Special Applications

Precision positioning and detection	Detergent resistant	Oil resistant	Print mark detection	Transparent material detection	Transparent bottle detection	Fork sensor
<b>E3Z Laser</b>	<b>E3ZM</b>	<b>E3ZM-C</b>	<b>E3ZM-V</b>	<b>E3ZM-B</b>	<b>E3Z-B</b>	<b>E3Z-G</b>
Small visible light spot	Detergent resistant stainless steel housing	Oil resistant stainless steel housing	Autoteach and white LED	General transparent materials or PET optimised models	Transparent bottle optimised optical system	Slot width 25 mm for Registration Mark and Edge Control

Miniature housing:

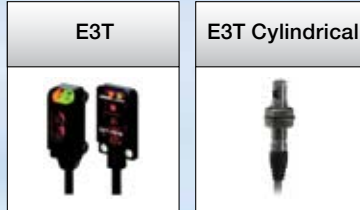





Cylindrical M18 housing:



Longer distance:







### Special Applications

Narrow beam sensor	Distance settable sensor	Oil resistant	Multi-voltage power supply	Structured object detection
				
<b>E3Z-L</b>	<b>E3Z-LS</b>	<b>E3Z-K</b>	<b>E3JK, E3JM, E3G-M</b>	<b>E3S-LS3</b>
Detects 0.1 mm diameter objects	Background/foreground suppression sensor (BGS/FGS)	Oil resistant in plastic housing	AC/DC power supply and relay output	Printed circuit board detector ignores holes or notches, components of varying heights
			<b>AC/DC</b>	







# Photoelectric Sensors

## Special Applications

High performance, small sensor	Long range sensor	UV power monitor	Oil resistant
			
<b>E3S-A</b>	<b>E3K</b>	<b>F3UV</b>	<b>E3S-C</b>
Timer, alarm, turbo aiming models	Material handling, door control and heavy duty switching applications	Monitor ultraviolet light (UV) intensity or wavelength	Long distance oil-resistant metal case

# Selection Table

				
Model	E3Z	E3Z-LASER	E3Z-L	E3Z-LS
Product type	General purpose	Laser	Narrow beam	Distance settable
Sensor type	<ul style="list-style-type: none"> <li>• Through-beam</li> <li>• Retro-reflective</li> <li>• Diffuse</li> <li>• Distance settable (BGS)</li> </ul>	<ul style="list-style-type: none"> <li>• Through-beam</li> <li>• Retro-reflective</li> <li>• Distance settable (BGS)</li> </ul>	<ul style="list-style-type: none"> <li>• Diffuse Reflective</li> </ul>	<ul style="list-style-type: none"> <li>• Distance settable</li> </ul>
Maximum sensing distances	<ul style="list-style-type: none"> <li>• Through-beam: 30 m</li> <li>• Retro-reflective: 4 m</li> <li>• Diffuse: 1 m</li> <li>• Distance settable: 200 mm</li> </ul>	<ul style="list-style-type: none"> <li>• Through-beam: 60 m</li> <li>• Retro-reflective: 15 m</li> <li>• Distance settable: 300 mm</li> </ul>	<ul style="list-style-type: none"> <li>• Diffuse reflective: 90 m</li> </ul>	<ul style="list-style-type: none"> <li>• Distance settable: 200 mm</li> </ul>
Supply voltage	12-24 VDC	12-24 VDC	12-24 VDC	12-24 VDC
Output type	Light-on/Dark-on	Light-on/Dark-on	Light-on/Dark-on	Light-on/Dark-on
Output state	NPN or PNP	NPN or PNP	NPN or PNP	NPN or PNP
Connections	Pre-wired, Connector	Pre-wired, Connector	Pre-wired, Connector	Pre-wired, Connector
IP rating	IP67	IP67	IP67	IP67





				
Model	E3Z-G	E3ZM	E3ZM-C	E3ZM-V
Product type	Grooved head	Stainless steel housing; Wash down rated	Oil resistant	Print mark detection
Sensor type	<ul style="list-style-type: none"> <li>• Fixed distance through-beam</li> </ul>	<ul style="list-style-type: none"> <li>• Through-beam</li> <li>• Retro-reflective</li> <li>• Diffuse</li> <li>• Background suppression</li> </ul>	<ul style="list-style-type: none"> <li>• Through-beam</li> <li>• Retro-reflective</li> <li>• Diffuse</li> <li>• Background suppression</li> </ul>	<ul style="list-style-type: none"> <li>• Diffuse reflective mark sensor</li> </ul>
Maximum sensing distances	<ul style="list-style-type: none"> <li>• 25 mm</li> </ul>	<ul style="list-style-type: none"> <li>• Through-beam: 15 m</li> <li>• Retro-reflective: 4 m</li> <li>• Diffuse: 1 m</li> <li>• Background suppression: 200 mm</li> </ul>	<ul style="list-style-type: none"> <li>• Through-beam: 15 m</li> <li>• Retro-reflective: 4 m</li> <li>• Diffuse: 1 m</li> <li>• Background suppression: 200 mm</li> </ul>	<ul style="list-style-type: none"> <li>• Diffuse: 12 mm</li> </ul>
Supply voltage	12-24 VDC	10-30 VDC	10-30 VDC	10-30 VDC
Output type	Light-on/Dark-on	Light-on/Dark-on	Light-on/Dark-on	Light-on/Dark-on
Output state	NPN or PNP	NPN or PNP	NPN or PNP	NPN or PNP
Connections	Pre-wired, Connector	Pre-wired, Connector	Pre-wired, Connector	Pre-wired, Connector
IP rating	IP64	IP67, IP69K	IP67, IP69K	IP67, IP69K





# Selection Table

				
Model	E3ZM-B	E3Z-B	E3FR/E3FZ	E3F2
Product type	PET bottle detection; stainless steel housing	PET bottle detection; plastic housing	Easy mount	Cylindrical plastic or brass
Sensor type	• Retro-reflective	• Retro-reflective	• Through-beam: • Retro-reflective • Diffuse • Background suppression	• Through-beam • Retro-reflective • Diffuse
Maximum sensing distances	• Retro-reflective: 500 mm	• Retro-reflective: 2 m	• Through-beam: 15 m • Retro-reflective: 4 m • Diffuse: 1 m • Background suppression: 200 mm	• Through-beam: 7 m • Retro-reflective: 2 m • Diffuse: 300 mm
Supply voltage	10-30 VDC	10-30 VDC	10-30 VDC	10-30 VDC 24-240 VAC
Output type	Light-on/Dark-on	Light-on/Dark-on	Light-on/Dark-on	Light-on/Dark-on
Output state	NPN or PNP	NPN or PNP	NPN or PNP	NPN or PNP
Connections	Pre-wired, Connector	Pre-wired, Connector	Pre-wired, Connector	Pre-wired, Connector
IP rating	IP67, IP69K	IP67	IP67, IP69K	IP66, IP67

				
Model	E3F2- _S	E3F2-41	E3S-CL	E3G
Product type	Cylindrical plastic or brass	Cylindrical plastic or brass	Distance settable	Long distance
Sensor type	• Through-beam • Retro-reflective • Diffuse	• Through-beam • Retro-reflective • Diffuse	• Distance settable	• Retro-reflective • Distance settable
Maximum sensing distances	• Through-beam: 7 m • Retro-reflective: 2 m • Diffuse: 300 mm	• Through-beam: 7 m • Retro-reflective: 2 m • Diffuse: 300 mm	• 500 mm	• Retro-reflective: 10 m • Distance settable: 2 m
Supply voltage	10-30 VDC 24-240 VAC	10-30 VDC 24-240 VAC	10-30 VDC	10-30 VDC
Output type	Light-on/Dark-on	Light-on/Dark-on	Light-on/Dark-on	Light-on/Dark-on
Output state	NPN or PNP	NPN or PNP	NPN or PNP	NPN or PNP; Relay output
Connections	Pre-wired, Connector	Pre-wired, Connector	Pre-wired	Pre-wired
IP rating	IP66, IP67	IP66, IP67	IP67	IP67 (with protective cover)

# Photoelectric Sensors

				
Model	E3JK	E3JM	E3S-LS3	E3T
Product type	All voltage	All voltage	Structured object detection	Miniature
Sensor type	<ul style="list-style-type: none"> <li>• Through-beam</li> <li>• Retro-reflective</li> <li>• Diffuse</li> </ul>	<ul style="list-style-type: none"> <li>• Through-beam</li> <li>• Retro-reflective</li> <li>• Diffuse</li> </ul>	<ul style="list-style-type: none"> <li>• Convergent Reflective</li> </ul>	<ul style="list-style-type: none"> <li>• Through-beam</li> <li>• Retro-reflective</li> <li>• Diffuse</li> <li>• Convergent reflective</li> <li>• Background suppression</li> </ul>
Maximum sensing distances	<ul style="list-style-type: none"> <li>• Through-beam: 4 m</li> <li>• Retro-reflective: 5 m</li> <li>• Diffuse: 300 mm</li> </ul>	<ul style="list-style-type: none"> <li>• Through-beam: 10 m</li> <li>• Retro-reflective: 4 m</li> <li>• Diffuse: 700 mm</li> </ul>	<ul style="list-style-type: none"> <li>• Convergent Reflective: 60 mm</li> </ul>	<ul style="list-style-type: none"> <li>• Through-beam: 2 m</li> <li>• Retro-reflective: 200 mm</li> <li>• Diffuse: 30 mm</li> <li>• Convergent reflective: 30 mm</li> <li>• Background suppression: 30 mm</li> </ul>
Supply voltage	12-240 VDC 24-240 VAC	12-240 VDC 24-240 VAC	12-24 VDC	12-24 VDC
Output type	Light-on/Dark-on	Light-on/Dark-on	Light-on only	Light-on/Dark-on
Output state	NPN or PNP	Relay or SSR	NPN or PNP	NPN or PNP
Connections	Pre-wired	Pre-wired, Terminal block	Pre-wired	Pre-wired
IP rating	IP64	IP64	IP40	IP65, IP67

				
Model	E3S-A	E3K	F3UV	E3Z-K
Product type	Built-in amplifier	Long distance	Ultraviolet intensity detection	Oil resistant
Sensor type	<ul style="list-style-type: none"> <li>• Through-beam</li> <li>• Retro-reflective</li> <li>• Diffuse</li> </ul>	<ul style="list-style-type: none"> <li>• Retro-reflective</li> <li>• Diffuse</li> </ul>	<ul style="list-style-type: none"> <li>• UV intensity</li> </ul>	<ul style="list-style-type: none"> <li>• Through-beam</li> <li>• Retro-reflective</li> <li>• Diffuse</li> </ul>
Maximum sensing distances	<ul style="list-style-type: none"> <li>• Through-beam: 7 m</li> <li>• Retro-reflective: 2 m</li> <li>• Diffuse: 700 mm</li> </ul>	<ul style="list-style-type: none"> <li>• Retro-reflective: 10 m</li> <li>• Diffuse: 2 m</li> </ul>	<ul style="list-style-type: none"> <li>• N/A</li> </ul>	<ul style="list-style-type: none"> <li>• Through-beam: 15 m</li> <li>• Retro-reflective: 4 m</li> <li>• Diffuse: 1 m</li> </ul>
Supply voltage	10-30 VDC	24-240 VDC 42-240 VAC	12-24 VDC	12-24 VDC
Output type	Light-on/Dark-on	Light-on/Dark-on	Analog	Light-on/Dark-on
Output state	NPN or PNP	Relay	NPN or PNP	NPN or PNP
Connections	Pre-wired, Connector	Plated steel screw terminals	Pre-wired	Pre-wired, Connector
IP rating	IP67	IP67	IP30	IP67









	
Model	<b>E3S-C</b>
Product type	Long distance metal body detector
Sensor type	<ul style="list-style-type: none"> <li>• Through-beam</li> <li>• Retro-reflective</li> <li>• Diffuse</li> </ul>
Maximum sensing distances	<ul style="list-style-type: none"> <li>• Through-beam: 30 m</li> <li>• Retro-reflective: 3 m</li> <li>• Diffuse: 2 m</li> </ul>
Supply voltage	10-30 VDC
Output type	Light-on/Dark-on
Output state	NPN or PNP
Connections	Pre-wired, Connector
IP rating	IP67

## General Purpose Sensor in Compact Plastic Housing

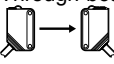
Compact housing size and high-power LED for excellent performance-size ratio and best value-performance ratio for standard applications.

- Minimal optical axis deviation for easy alignment
- IP67 and IP69K for highest water resistance
- Intensive shielding for highest noise immunity (EMC)
- Multiple molding housing for high mechanical resistance

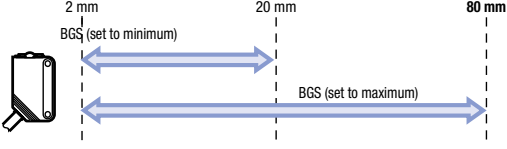
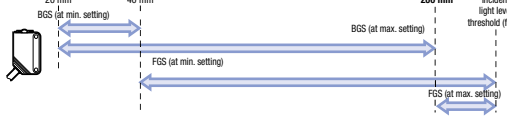

Sensor type		Sensing distance	Connection Method		Model	
			 M8		NPN output	PNP output
 Through-beam (Infrared light)		30 m	—	2 m	E3Z-T62	E3Z-T82
			■	—	E3Z-T67	E3Z-T87
		10 m	—	2 m	E3Z-T61A	E3Z-T81A
			■	—	E3Z-T66A	E3Z-T86A
 Retro-reflective with M.S.R. (Red light)		0.1 to 4 m (with E39-R15)	—	2 m	E3Z-R61	E3Z-R81
			■	—	E3Z-R66	E3Z-R86
 Retro-reflective without M.S.R. (Infrared light)		0.1 to 5 m (with E39-R15)	—	2 m	E3Z-R61-4	E3Z-R81-4
			■	—	E3Z-R66-4	E3Z-R86-4
 Diffuse-reflective (Infrared light)		1 m (adjustable)	—	2 m	E3Z-D62	E3Z-D82
			■	—	E3Z-D67	E3Z-D87
 Diffuse-reflective wide beam (Infrared light)		100 mm (adjustable)	—	2 m	E3Z-D61	E3Z-D81
			■	—	E3Z-D66	E3Z-D86
 Distance-settable (background suppression) <sup>2</sup>	Small spot (Red light)	 2 mm BGS (set to minimum)      20 mm      80 mm BGS (set to maximum)	—	2 m	E3Z-LS63	E3Z-LS83
			■	—	E3Z-LS68	E3Z-LS88
	Standard (Red light) (note 1)	 20 mm BGS (at min. setting)      40 mm      200 mm      Incident light level threshold (fixed) BGS (at max. setting)      FGS (at min. setting)      FGS (at max. setting)	—	2 m	E3Z-LS61 <sup>2</sup>	E3Z-LS81 <sup>2</sup>
			■	—	E3Z-LS66 <sup>2</sup>	E3Z-LS86 <sup>2</sup>

<sup>1</sup> Infrared light models available





<sup>2</sup> To order with 30 cm long pigtail and a M12, M8 3-pin or 4-pin connector please contact your OMRON representative

## LASER Sensor in Compact Plastic Housing

The E3Z LASER sensor in compact plastic housing features visible Laser light for precision positioning and detection applications.

- Visible LASER light for precision positioning and small object detection
- High power laser diode for long range precision
- Class 1 LASER (JIS, IEC) Class 2 (FDA) LASER
- Precise background suppression and low black/white error for accurate detection

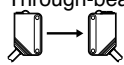
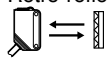

Sensor type	Sensing distance	Response time	Connection Method		Model	
			 M8		NPN output	PNP output
Through-beam 	60 m	1 ms	—	2 m	E3Z-LT61 2M	E3Z-LT81 2M
			■	—	E3Z-LT66	E3Z-LT86
Retro-reflective with M.S.R 	0.3 to 15 m (with E39-R15)	1 ms	—	2 m	E3Z-LR61 2M	E3Z-LR81 2M
			■	—	E3Z-LR66	E3Z-LR86
Distance-settable (background suppression) 	20 to 300 mm	1 ms	—	2 m	E3Z-LL61 2M	E3Z-LL81 2M
	25 to 300 mm		■	—	E3Z-LL66	E3Z-LL86
		25 to 300 mm	0.5 ms	—	2 m	E3Z-LL63 2M
	25 to 300 mm		0.5 ms	■	—	E3Z-LL68

Note: To order with 30 cm long pigtail and a M12, M8 3-pin or M8 4-pin connector please contact your OMRON representative

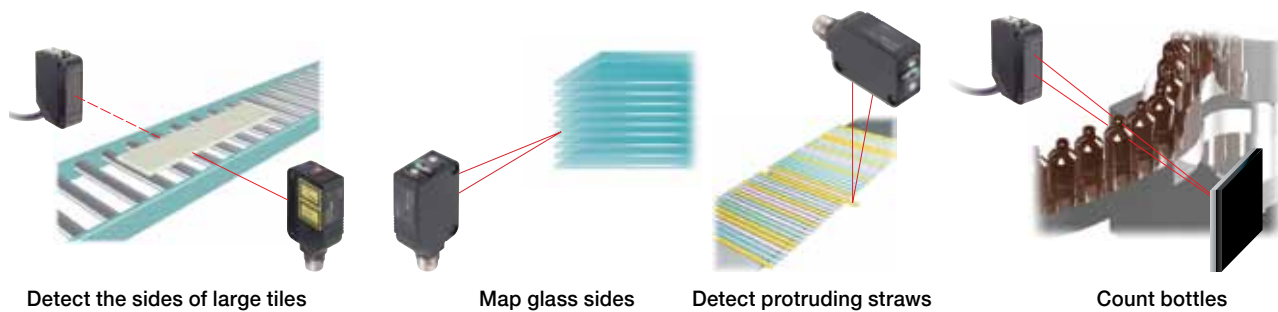

Detect the sides of large tiles

Map glass sides

Detect protruding straws

Count bottles

## Detergent Resistant Photoelectric Sensor in Compact Stainless Steel Housing

Compact housing size and high power LED for excellent performance-size ratio in a rugged, detergent-resistant stainless steel housing for demanding environments.

- High grade stainless steel housing (SUS316L)
- IP67 and IP69K for highest water resistance
- ECOLAB tested and certified detergent resistance



Sensor type	Sensing distance	Connection Method			Model	
		M8			NPN output	PNP output
Through-beam 	15 m	—	2 m	*1 For ordering digital versions replace "2M" of the cable types with: - S1J: for M12 stainless steel plug with 30 cm cable - S3J: for M8 4-pin stainless steel plug with 30cm cable - S5J: for M8 3-pin stainless steel plug with 30cm cable (except for background suppression types) - M1J: for M12 brass plug with 30cm cable - M3J: for M8 4-pin brass plug with 30 cm cable - M5J: for M8 3-pin brass plug with 30 cm cable (except for background suppression types)	E3ZM-T61 2M	E3ZM-T81 2M
	0.8 m with built in slit	■	—		E3ZM-T66	E3ZM-T86
Retro-reflective with M.S.R 	0.1 to 4 m (with E39-R1S)	—	2 m		E3ZM-T63 2M	E3ZM-T83 2M
		■	—		E3ZM-T68	E3ZM-T88
Diffuse-reflective 	1 m (adjustable)	—	2 m		E3ZM-R61 2M	E3ZM-R81 2M
		■	—		E3ZM-R66	E3ZM-R86
Diffuse-reflective (background suppression) 	10 to 100 mm (fixed)	—	2 m		E3ZM-D62 2M	E3ZM-D82 2M
		■	—		E3ZM-D67	E3ZM-D87
	10 to 200 mm (fixed)	—	2 m		E3ZM-LS61X 2M <sup>2</sup>	E3ZM-LS81X 2M <sup>2</sup>
		■	—		E3ZM-LS66X <sup>2</sup>	E3ZM-LS86X <sup>2</sup>
					E3ZM-LS64X 2M <sup>2</sup>	E3ZM-LS84X 2M <sup>2</sup>
					E3ZM-LS69X <sup>2</sup>	E3ZM-LS89X <sup>2</sup>

<sup>2</sup>E3ZM-LS\_X are fixed LIGHT-ON models. For Fixed DARK-ON models order E3ZM-LS\_Y and for L-NO/D-NO selectable by wire please order E3ZM-LS\_H.



Robust construction



Tight housing

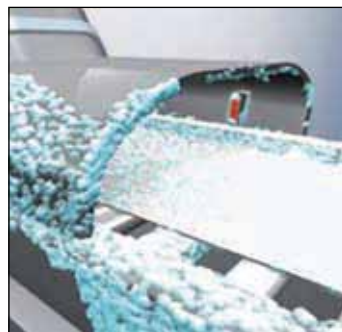

Detergent resistant



## Oil-resistant Photoelectric Sensor in Compact Stainless Steel Housing

The oil-resistant compact photoelectric sensor in a robust stainless steel housing features reliable object detection in dirty and mechanically demanding environments such as automotive assembly lines.

- Oil-resistant stainless steel housing
- IP67 and IP69k for highest water resistance
- High visibility orange LED in through-beam model for easy alignment



Sensor type	Sensing distance	Connection Method			Model	
		M8	2 m	M12	NPN output	PNP output
Through-beam 	15 m (infrared light)	—	2 m	—	E3ZM-CT61 2M	E3ZM-CT81 2M
		—	—	■	E3ZM-CT61-M1TJ	E3ZM-CT81-M1TJ
		■	—	—	E3ZM-CT66	E3ZM-CT86
	20 m (Orange light)	—	2 m	—	E3ZM-CT62B 2M	E3ZM-CT82B 2M
		—	—	■	E3ZM-CT62B-M1TJ	E3ZM-CT82B-M1TJ
		■	—	—	E3ZM-CT67B	E3ZM-CT87B
Retro-reflective with M.S.R 	0.1 to 4 m (with E39-R1S)	—	2 m	—	E3ZM-CR61 2M	E3ZM-CR81 2M
		—	—	■	E3ZM-CR61-M1TJ	E3ZM-CR81-M1TJ
		■	—	—	E3ZM-CR66	E3ZM-CR86
Diffuse-reflective 	1 m (adjustable)	—	2 m	—	E3ZM-CD62 2M	E3ZM-CD82 2M
		—	—	■	E3ZM-CD62-M1TJ	E3ZM-CD82-M1TJ
		■	—	—	E3ZM-CD67	E3ZM-CD87
Diffuse-reflective (background suppression) 	10 to 100 mm (fixed)	—	2 m	—	E3ZM-CL61H 2M	E3ZM-CL81H 2M
		—	—	■	E3ZM-CL61H-M1TJ	E3ZM-CL81H-M1TJ
		■	—	—	E3ZM-CL66H	E3ZM-CL86H
	10 to 200 mm (fixed)	—	2 m	—	E3ZM-CL64H 2M	E3ZM-CL84H 2M
		—	—	■	E3ZM-CL64H-M1TJ	E3ZM-CL84H-M1TJ
		■	—	—	E3ZM-CL69H	E3ZM-CL89H





Note: M12 connector types use Omron Automation and Safety's XS5 Series "Twist & Click" M12 connector cordsets, 30 cm standard length.

## Print Mark Detection Photoelectric Sensor in Compact Stainless Steel Housing

The detergent resistant photoelectric sensor in a robust stainless steel housing provides reliable detection of all common print marks in food packaging applications.

- White LED for stable detection of differently colored or black print marks
- SUS 316L stainless steel housing
- Easy-to-use teach-in button or remote teach
- Fast response time of 50  $\mu$ s



Sensor type	Sensing distance	Connection Method		Model	
		 M8		NPN output	PNP output
Mark sensor 	12 $\pm$ 2 mm	—	2 m	E3ZM-V61 2M	E3ZM-V81 2M
			—	E3ZM-V66	E3ZM-V86

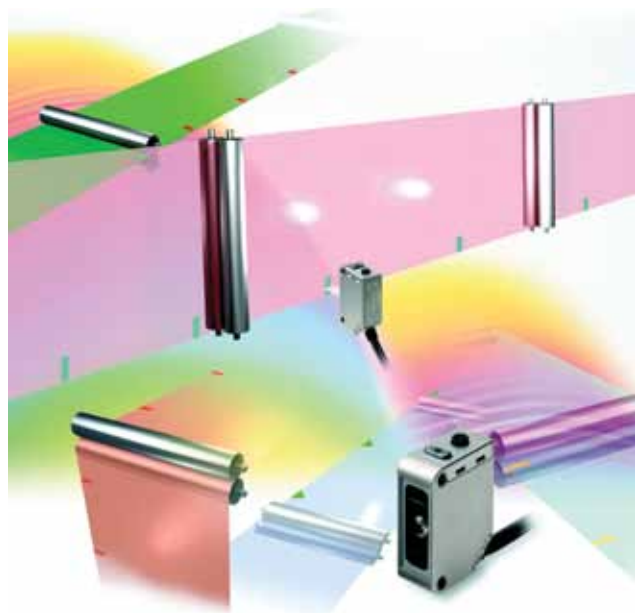

## Transparent Object Detection Sensor in Compact Stainless Steel Housing

The E3ZM-B family provides models for general transparent material detection and specialized models providing highest stability for the detection of PET bottles.

- Detergent resistant compact SUS316L housing
- Includes Bi-refrangent, P-opaquin sensing technology to provide the margin necessary to overcome the challenges in geometry, color and contents of PET bottle detection which standard retro-reflective sensors can not perform
- Simple push button teach operation
- Unique AC3 technology compensates for lens contamination to maintain expected sensor output
- IP69K (DIN 40050-9) compliant
- 316L stainless steel body resists detergents and disinfectants
- High noise immunity against interference from inverters and other inductive loads



Sensor type		Sensing distance	Special reflector	Connection Method		Model	
				M8		NPN output	PNP output
Retro-reflective with M.S.R 	Optimized for PET bottles and trays	100 to 500 mm (teachable)	Order separately <sup>1</sup>	—	2 m	E3ZM-B61 2M	E3ZM-B81 2M
				■	—	E3ZM-B66	E3ZM-B86
			E39-RP1 included	—	2 m	E3ZM-B61-C 2M	E3ZM-B81-C 2M
				■	—	E3ZM-B66-C	E3ZM-B86-C
Retro-reflective with M.S.R 	For all transparent media (glass, PET, foils)	100 to 500 mm (potentiometer adjustment) <sup>3</sup>	Order separately <sup>3</sup>	—	2 m	E3ZM-B61T 2M	E3ZM-B81T 2M
				■	—	E3ZM-B66T	E3ZM-B86T

<sup>1</sup> For higher signal stability using circular polarization functionality for PET bottles, order special reflector E39-RP1 separately

<sup>2</sup> Teachable all-transparent-media types are available. Contact your Omron Automation and Safety representative

<sup>3</sup> Order reflector separately: Use E39-RP1 for 500 mm sensing distance; E39-RP37 or E39-RSP1 for 250 mm sensing distance

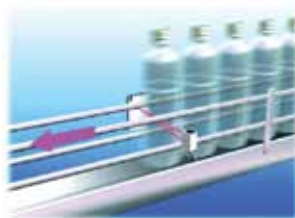

# E3Z-B Photoelectric Sensors



## Transparent Bottle Detection Photoelectric Sensor in Compact Plastic Housing

The E3Z-B provides easy adjustment for the detection of a large variety of standard transparent objects.



- Detects a wide range of bottles from single bottles to sets of stocked bottles
- IP67/IP69K tested for highest water resistance



Sensor type	Sensing distance (with E39-R1S reflector)	Connection Method		Model	
		M8		NPN output	PNP output
 Retro-reflective without M.S.R.	80 to 500 mm (adjustable)	—	2 m	E3Z-B61 2M	E3Z-B81 2M
		■	—	E3Z-B66	E3Z-B86
	0.5 to 2 m (adjustable)	—	2 m	E3Z-B62 2M	E3Z-B82 2M
		■	—	E3Z-B67	E3Z-B87

# E3Z-G Photoelectric Sensors



## Photoelectric Sensor in Plastic Fork Shape Housing

The forked shape optical through-beam sensors combine simple installation with reliable passage detection of object, machine parts or transportation elements like hanging carriers.



- Slotted head eliminates the need for optical axis adjustment
- 1 or 2 axis models

Sensor type	Sensing distance	Number of optical axes	Connection Method		Model	
					NPN output	PNP output
 Through-beam 25 mm (Infrared light)		1	2 m	—	E3Z-G61	E3Z-G81
			—	■ M8 4-pin	E3Z-G61-M3J	E3Z-G81-M3J
		2	2 m	—	E3Z-G62	E3Z-G82
			—	■ M8 4-pin	E3Z-G62-M3J	E3Z-G82-M3J

## Narrow-Beam Sensor Detects Small Objects

- Small 2.5 mm beam diameter at 90 mm sensing distance enables detection through small holes or gaps
- Detect objects as small as 0.1 mm diameter
- Adjustable distance setting of  $90 \pm 30$  mm
- Visible red light beam simplifies alignment for visual checking of sensing spot position
- Integrated circuit design with advanced LED assures long sensing distances
- High noise immunity against interference from inverters and other inductive loads
- Rated IP67, withstands 1200 psi washdown
- Switch-selectable, Light-ON/Dark-ON operation



## Narrow-Beam Sensors

Sensor type	Setup	Features	Light source	Sensing distance	Connection method	Model	
						NPN output	PNP output
Diffuse reflective		Detects 0.1 mm dia. objects	Red (650 nm)	90 ±30 mm	Pre-wired	E3Z-L61	E3Z-L81
					4-pin M8 Connector	E3Z-L66	E3Z-L86

### Miniature Distance Settable Sensors with Built-In Amplifiers

- Detect glossy/uneven surfaces with foreground suppression
- Ignore objects beyond the set distance such as a conveyor belt or rail using background suppression
- Web/edge position detection sensors (E3Z-LS63/-LS83) with 2 mm spot eliminate background influences in printing, converting and packaging
- Detect presence of strip and sheet materials and non-woven fabric edges with 2% max. differential travel to compensate for vibration (E3Z-LS63/-LS83)
- Integrated circuit design with advanced LED assures long sensing distances
- High noise immunity against interference from inverters and other inductive loads
- Rated IP67, withstands 1200 psi washdown
- Switch-selectable, Light-ON/Dark-ON operation



### Background/Foreground Suppression Sensors

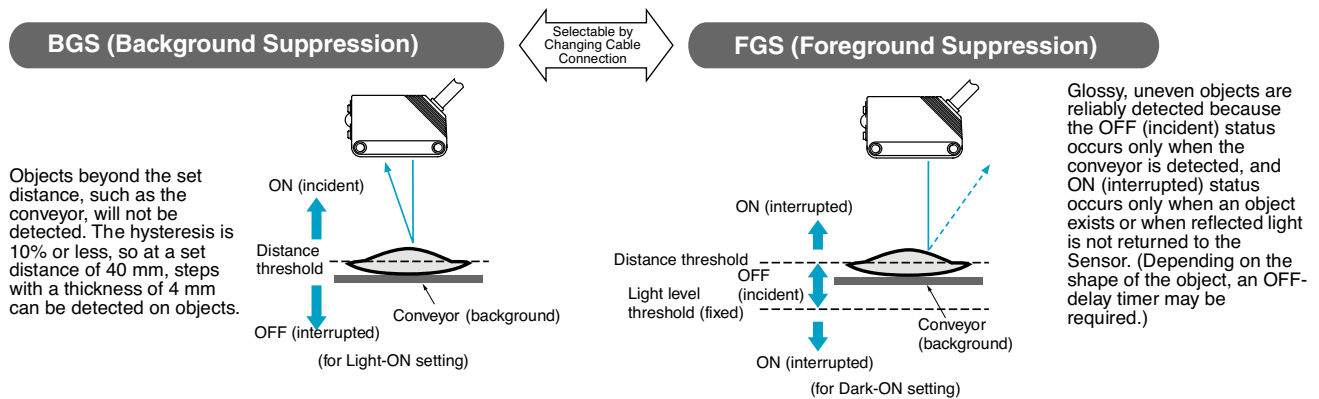

Sensor type	Setup	Features	Light source	Sensing distance	Connection method	Model	
						NPN output	PNP output
Distance settable		Resists interference from fluorescent lighting	Red (680 nm)	Background setting 20 to 200 mm Foreground setting 40 to 200+ mm	Pre-wired	E3Z-LS61	E3Z-LS81
					4-pin M8 Connector	E3Z-LS66	E3Z-LS86
		Web/edge position detector	Red (650 nm)	Background setting 2 to 80 mm	Pre-wired	E3Z-LS63	E3Z-LS83
					4-pin M8 Connector	E3Z-LS68	E3Z-LS88

## Oil-Resistant Sensors with Built-In Amplifiers

- Sensor housing includes special coating to resist effects in environments subject to high pH oil mists, coolants and medium pH detergents that aggressively attach sensors
- Long distance sensing: 15 m through-beam models; 3 m retro-reflective; 1 m diffuse-reflective
- High noise immunity against interference from inverters and other inductive loads
- Rated IP67, withstands 1200 psi washdown
- Switch-selectable, Light-ON/Dark-ON operation



## Sensor Type





Sensor type	Setup	Features	Light source	Sensing distance	Connection method	Model	
						NPN output	PNP output
Through-beam		—	Infrared (870 nm)	15 m	Pre-wired	E3Z-T61K	E3Z-T81K
					Pigtail, 4-pin M8	E3Z-T61K-M3J 0.3M	E3Z-T81K-M3J 0.3M
Retro-reflective		Polarized; Order reflector separately	Red (660 nm)	0.1 to 4 m with E39-R1S reflector 0.1 to 3 m with E39-R1 reflector	Pre-wired	E3Z-R61K	E3Z-R81K
					Pigtail, 4-pin M8	E3Z-R61K-M3J 0.3M	E3Z-R81K-M3J 0.3M
Diffuse reflective		Wide view	Infrared (860 nm)	5 to 100 mm	Pre-wired	E3Z-D61K	E3Z-D81K
					Pigtail, 4-pin M8	E3Z-D61K-M3J 0.3M	E3Z-D81K-M3J 0.3M
		Standard		1 m	Pre-wired	E3Z-D62K	E3Z-D82K
					Pigtail, 4-pin M8	E3Z-D62K-M3J 0.3M	E3Z-D82K-M3J 0.3M

## Easy Mounting Photoelectric Sensor in Short Plastic M18 Housing





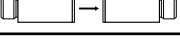
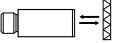

- High power LED for enhanced sensing distance
- SecureClick snap mounting for fast installation

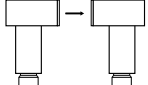

### Snap Mounting - E3FZ

Sensor type	Sensing distance	Connection method		Model	
		 M12		NPN output	PNP output
Through-beam 	15 m	—	2 m	E3FZ-T61H 2M	E3FZ-T81H 2M
		■	—	E3FZ-T66H	E3FZ-T86H
Retro-reflective with M.S.R 	0.1 to 4 m (with E39-R1S reflector)	—	2 m	E3FZ-R61H 2M	E3FZ-R81H 2M
		■	—	E3FZ-R66H	E3FZ-R86H
Diffuse-reflective 	1 m (adjustable)	—	2 m	E3FZ-D62 2M	E3FZ-D82 2M
		■	—	E3FZ-D67	E3FZ-D87
Diffuse-reflective (background suppression) 	100 mm (fixed)	—	2 m	E3FZ-LS61H 2M	E3FZ-LS81H 2M
	200 mm (fixed)	■	—	E3FZ-LS66H	E3FZ-LS86H
		—	2 m	E3FZ-LS64H 2M	E3FZ-LS84H 2M
		■	—	E3FZ-LS69H	E3FZ-LS89H

### Radial Mounting (90° Angled Optics) - E3FR

Sensor type	Sensing distance	Connection method		Model	
		 M12		NPN output	PNP output
Through-beam 	15 m	—	2 m	E3FR-T61H 2M	E3FR-T81H 2M
		■	—	E3FR-T66H	E3FR-T86H
Retro-reflective with M.S.R 	0.1 to 4 m (with E39-R1S reflector)	—	2 m	E3FR-R61H 2M	E3FR-R81H 2M
		■	—	E3FR-R66H	E3FR-R86H
Diffuse-reflective 	1 m (adjustable)	—	2 m	E3FR-D62 2M	E3FR-D82 2M
		■	—	E3FR-D67	E3FR-D87
Diffuse-reflective (background suppression) 	100 mm (fixed)	—	2 m	E3FR-LS61H 2M	E3FR-LS81H 2M
	200 mm (fixed)	■	—	E3FR-LS66H	E3FR-LS86H
		—	2 m	E3FR-LS64H 2M	E3FR-LS84H 2M
		■	—	E3FR-LS69H	E3FR-LS89H

<sup>3</sup> Measured with reflector E39-R1S



## Photoelectric Sensor in Plastic or Brass M18 Housing

The E3F2 sensors in cylindrical M18 plastic or brass housings are ideally suited for a wide range of standard applications providing high reliability and long sensor lifetime with excellent price-performance ratio.



- Plastic or metal (brass) housings
- IP67, IP69K for highest water resistance
- Special beam models available (see complete datasheet at [omron247.com](http://omron247.com))

Sensor type	Sensing distance	Housing material	Connection method		Model	
			M12		NPN output	PNP output
Through-beam 	7 m	Plastic	—	2 m	E3F2-7C4	E3F2-7B4
		Brass	—	2 m	E3F2-7C4-M	E3F2-7B4-M
		Plastic	■	—	E3F2-7C4-P1	E3F2-7B4-P1
		Brass	■	—	E3F2-7C4-M1-M	E3F2-7B4-M1-M
Retro-reflective with M.S.R 	0.1 to 4 m with E39-R1S reflector (adjustable)	Plastic	—	2 m	E3F2-R4C4-E	E4F2-R4B4-E
		Brass	—	2 m	E3F2-R4C4-M-E	E3F2-R4B4-M-E
		Plastic	■	—	E3F2-R4C4-P1-E	E3F2-R4B4-P1-E
		Brass	■	—	E3F2-R4C4-M1-M-E	E3F2-R4B4-M1-M-E
Diffuse-reflective 	0.3 m (adjustable)	Plastic	—	2 m	E3F2-DS30C4	E3F2-DS30B4
		Brass	—	2 m	E3F2-DS30C4-M	E3F2-DS30B4-M
		Plastic	■	—	E3F2-DS30C4-P1	E3F2-DS30B4-P1
		Brass	■	—	E3F2-DS30C4-M1-M	E3F2-DS30B4-M1-M
	1 m (adjustable)	Plastic	—	2 m	E3F2-D1C4	E3FR-D1B4
		Brass	—	2 m	E3F2-D1C4-M	E3F2-D1B4-M
		Plastic	■	—	E3F2-D1C4-P1	E3F2-D1B4-P1
		Brass	■	—	E3F2-D1C4-M1-M	E3F2-D1B4-M1-M
Diffuse-reflective (background suppression) 	100 mm (fixed)	Plastic	—	2 m	E3F2-LS10C4	E3F2-LS10B4
		Brass	—	2 m	E3F2-LS10C4-M	E3F2-LS10B4-M
		Plastic	■	—	E3F2-LS10C4-P1	E3F2-LS10B4-P1
		Brass	■	—	E3F2-LS10C4-M1-M	E3F2-LS10B4-M1-M



High ambient light immunity

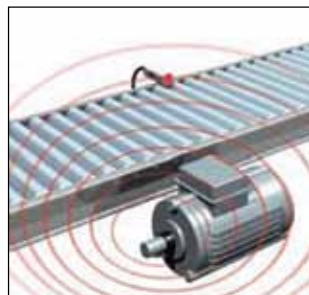





High electromagnetic noise resistance

## Photoelectric Sensor in Stainless Steel M18 Housing

For areas that undergo frequent cleaning the stainless steel housing of the E3F2-\_-S provides enhanced detergent resistance and longer sensor lifetime.

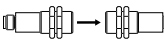
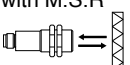

- IP67, IP69K for highest water resistance
- Enhanced detergent resistance certified by ECOLAB

Sensor type	Sensing distance	Housing material	Connection method		Model	
			 M12		NPN output	PNP output
Through-beam 	7 m	Stainless steel	—	2 m	E3F2-7C4-S	E3F2-7B4-S
			■	—	E3F2-7C4-M1-S	E3F2-7B4-M1-S
Retro-reflective with M.S.R 	0.1 to 4 m with E39-R1S reflector (adjustable)	Stainless steel	—	2 m	E3F2-R4C4-S-E	E3F2-R4B4-S-E
			■	—	E3F2-R4C4-M1-S-E	E3F2-R4B4-M1-S-E
Diffuse-reflective 	0.3 m (adjustable)	Stainless steel	—	2 m	E3F2-DS30C4-S	E3F2-DS30B4-S
			■	—	E3F2-DS30C4-M1-S	E3F2-DS30B4-M1-S
	1 m (adjustable)	Stainless steel	—	2 m	E3F2-D1C4-S	E3F2-D1B4-S
			■	—	E3F2-D1C4-M1-S	E3F2-D1B4-M1-S
Diffuse-reflective (background suppression) 	100 mm (fixed)	Stainless steel	—	2 m	E3F2-LS10C4-S	E3F2-LS10B4-S
			■	—	E3F2-LS10C4-M1-S	E3F2-LS10B4-M1-S







High water and detergent resistance

## Photoelectric Sensor in Plastic or Brass Radial (90° angled) M18 Housing

Radial (90° angled) optics for easy mounting, installation and adjustment

- Diffuse-reflective and retro-reflective models
- IP67 and IP69K

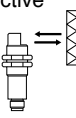

Sensor type	Sensing distance	Housing material	Connection method		Model	
			 M12		NPN output	PNP output
Retro-reflective with M.S.R. 	0.1 to 2 m with E39-R1S reflector	Plastic	—	2 m	E3F2-R2RC41-E	E3F2-R2RB41-E
		Brass	—	2 m	E3F2-R2RC41-M-E	E3F2-R2RB41-M-E
		Plastic	■	—	E3F2-R2RC41-P1-E	E3F2-R2RB41-P1-E
		Brass	■	—	E3F2-R2RC41-M1-M-E	E3F2-R2RB41-M1-M-E
Diffuse-reflective 	300 mm (adjustable)	Plastic	—	2 m	E3F2-DS30C41	E3F2-DS30B41
		Brass	—	2 m	E3F2-DS30C41-M	E3F2-DS30B41-M
		Plastic	■	—	E3F2-DS30C41-P1	E3F2-DS30B41-P1
		Brass	■	—	E3F2-DS30C41-M1-M	E3F2-DS30B41-M1-M

# E3S-CL Photoelectric Sensors

Quick Link  
B249

## Distance-Settable Sensor in Metal Housing

- Minimal black/white error for highest reliability detecting differently colored objects
- Setting distance up to 500 mm with reliable background suppression
- Stable detection regardless of the target workpiece color, material or size
- Simple to set distance with 6-turn adjustor and indicator



Sensor type	Light source	Sensing distance	Connection method		Model
Distance-settable (background suppression)	Red (700mm)		2 m	—	E3S-CL1
	—	—	—	■ M12	E3S-CL1-M1J
Distance-settable (background suppression)	Infrared (860mm)		2 m	—	E3S-CL2
	—	—	—	■ M12	E3S-CL2-M1J

# E3G Photoelectric Sensors

Quick Link  
B228

## Long Distance Sensor in Plastic Housing

Long distance retro-reflective and teachable distance-settable sensors in plastic housing.

- Distance-settable model with 1.2 m maximum setting distance
- Light-On/Dark-On operation, NPN/PNP output switch selectable





Sensor type	Sensing distance	Connection method		Model
Retro-reflective with M.S.R.	0.5 to 10 m measured with E39-R2	—	2 m	E3G-R13-G 2M
		■	—	E3G-R17-G
Distance-settable (background suppression)	0.2 to 2 m (0.2 to 1.2 m distance settable)	—	2 m	E3G-L73 2M
		■	—	E3G-L77

## All Voltage (AC/DC) Photoelectric Sensor in Plastic Housing

The square sized E3JK family uses 12 to 240 VDC and 24 to 240 VAC supply voltage

- Retro-reflective models accurately detect shiny objects
- Relay outputs with long life expectancy and high switching capacity (3 A, 250 VAC)
- cUL recognized

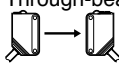
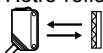
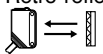

Sensor type	Sensing distance	Connection method	Operation mode	Model
				
Through-beam 	5 m (Infrared light)	2 m	Light ON	E3JK-5M1 -US
			Dark ON	E3JK-5M2 -US
Retro-reflective with M.S.R. 	2 m measured with E39-R1 (Red light)		Light ON	E3JK-R2M1 -US
			Dark ON	E3JK-R2M2 -US
Retro-reflective without M.S.R. 	4 m (adjustable) measured with E39-R1 (Red light)		Light ON	E3JK-R4M1 -US
			Dark ON	E3JK-R4M2 -US
Diffuse-reflective 	300 mm (adjustable) (Infrared light)		Light ON	E3JK-DS30M1 -US
			Dark ON	E3JK-DS30M2 -US

Note: All part numbers include mounting hardware, Retro--reflective models include E39-R1 reflector

## All Voltage (AC/DC) Photoelectric Sensor in Plastic Housing

The square sized E3JM family uses 12 to 240 VDC and 24 to 240 VAC supply voltage, an enhanced sensing distance and a timer function.

- Easy to wire terminal block speeds installation and servicing
- Relay or solid state relay output
- Timer function models available
- Mounting hardware and terminal protection cover included

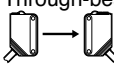
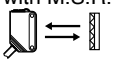
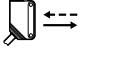

Sensor type	Sensing distance	Connection method	Operation mode	Model		
				Relay output	DC SSR output	
					NPN Output	PNP Output
Through-beam 	10 m (Infrared light)	Terminal block (with PG 13.5 conduit opening)	—	E3JM-10M4-G-N	E3JM-10S4-G-N	E3JM-10R4-G-N
			ON or OFF delay 0.1 s to 5 s (adjustable)	E3JM-10M4T-G-N	E3JM-10S4T-G-N	E3JM-10R4T-G-N
Retro-reflective with M.S.R. 	4 m with E39-R1 reflector (Red light)		—	E3JM-R4M4-G	E3JM-R4S4-G	E3JM-R4R4-G
			ON or OFF delay 0.1 s to 5 s (adjustable)	E3JM-R4M4T-G	E3JM-R4S4T-G	E3JM-R4R4T-G
Diffuse-reflective 	700 mm (adjustable) (Infrared light)		—	E3JM-DS70M4-G	E3JM-DS70S4-G	E3JM-DS70R4-G
			ON or OFF delay 0.1 s to 5 s (adjustable)	E3JM-DS70M4T-G	E3JM-DS70S4T-G	E3JM-DS70R4T-G

# E3G-M Photoelectric Sensors

## Long Distance All Voltage (AC/DC) Photoelectric Sensor

The E3G-M series offers the long sensing distance of the E3G family for all voltage (AC/DC) installations.

- 12 to 240 VDC and 24 to 240 VAC
- Terminal block connection

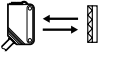
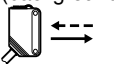

Sensor type	Sensing distance	Connection method	Timer Function	Model
				Relay output
Retro-reflective with M.S.R. 	0.5 to 10 m with E39-R2 reflector (Red light)	Terminal block	—	E3G-MR19-G
			ON or OFF delay 0 to 5 s (adjustable)	E3G-MR19T-G
Distance-settable (background detection) 	0.2 to 2 m (0.2 to 1.2 m distance settable) (Infrared light)		—	E3G-ML79-G
			ON or OFF delay 0 to 5 s (adjustable)	E3G-ML79T-G

## Photoelectric Sensor for Structured Object Detection in Plastic Housing

The special wide beam and limited-reflective optics of the E3S-LS3 ensures reliable detection of structured objects (with holes or different heights) and can be used for example to detect printed circuit boards (PCBs).



- Wide beam and limited-reflective for reliable detection of structured, shiny and irregularly shaped objects

Sensor type	Sensing distance	Connection method		Output type	Timer function	Model
						NPN output
Convergent-reflective 	20 to 35 mm (red light)	2 m	—	NPN	No	E3S-LS3N 2M
	10 to 60 mm (red light)				Yes	E3S-LS3NW 2M
	20 to 35 mm	2 m	—	PNP	No	E3S-LS3P 2M
					Yes	E3S-LS3PT 2M
		—	■ M8 4-pin		No	E3S-LS3P-M5J
					Yes	E3S-LS3PT-M5J
		—	■ M8 4-pin		No	E3S-LS3P-M3J
					Yes	E3S-LS3PT-M3J
	10 to 60 mm	2 m	—	No	E3S-LS3PW 2M	
				Yes	E3S-LS3PWT 2M	
		—	■ M8 3-pin	No	E3S-LS3PW-M5J	
				Yes	E3S-LS3PWT-M5J	
—		■ M8 4-pin	No	E3S-LS3PW-M3J		
			Yes	E3S-LS3PWT-M3J		

## Photoelectric Sensor in Miniature Plastic Housing

Small sized photoelectric sensors in flat, side view and M5 cylindrical shapes for demanding mounting conditions.

- Small size with precision pinpoint LED
- 3.5 mm flat model with reliable background suppression and small black/white error
- Unique optical alignment technology ensuring minimal deviation of optical axis
- High EMC and ambient light immunity



Sensor type	Sensing distance	Connection Method		Operation mode	Model (note 1)	
					NPN output	PNP output
Through-beam 	1 m	2 m	To order pigtail connector versions, replace "2M" for cable types if present, then add a suffix: - M1TJ 0.3M: M12 with 30 cm cable - M3J 0.3M: M8 4-pin with 30 cm cable	Light- ON	E3T-ST11	E3T-ST13
	300 mm			Dark-ON	E3T-ST12	E3T-ST14
				Light- ON	E3T-ST21	E3T-ST23
	Dark-ON			E3T-ST22	E3T-ST24	
Through-beam 	500 mm			Light- ON	E3T-FT11	E3T-FT13
	300 mm			Dark-ON	E3T-FT12	E3T-FT14
				Light- ON	E3T-FT21	E3T-FT23
	Dark-ON			E3T-FT22	E3T-FT24	
Through-beam, M5 	1 m			Dark-ON	E3T-CT12	E3T-CT14
Through-beam, M5 	500 m			Dark-ON	E3T-CT22S	E3T-CT24S
Retro-reflective (note 3)	30 to 200 mm on reflectors/ 10 to 100 mm on reflective foils (note 2)			Light- ON	E3T-SR41-C	E3T-SR43-C
				Dark-ON	E3T-SR42-C	E3T-SR44-C
Diffuse-reflective 	5 to 30 mm			Light- ON	E3T-FD11	E3T-FD13
				Dark-ON	E3T-FD12	E3T-FD14
Diffuse-reflective (with adjuster), M6 	3-50 mm			Dark-ON	E3T-CD11	E3T-CD13
Limited-reflective 	5 to 15 mm	Light- ON	E3T-SL11	E3T-SL13		
	5 to 30 mm	Dark-ON	E3T-SL12	E3T-SL14		
		Light- ON	E3T-SL21	E3T-SL23		
	Dark-ON	E3T-SL22	E3T-SL24			
Diffuse-reflective (background suppression) 	1 to 15 mm	Light- ON	E3T-FL11	E3T-FL13		
	1 to 30 mm	Dark-ON	E3T-FL12	E3T-FL14		
		Light- ON	E3T-FL21	E3T-FL23		
	Dark-ON	E3T-FL22	E3T-FL24			

Note: 1- For pre-wired models with robotic cables add '-R' to the order code (example: E3T-FT21R 2M)

2- The distances are measured with reflector E39-R4 and reflective foil E39-R37-CA. For applications with shorter distances between the sensor and the reflector contact your Omron Automation and Safety representative. Light-ON E3T-SR41-C 2M\*3

3- Order reflector separately. Models with included reflectors are available.



# E3S-A Photoelectric Sensors

Quick Link  
B232

## High Performance Small DC Sensors

- Enclosure meets NEMA 4X, 6 and IP67
- User-friendly features for ease of installation and use
- Timer/alarm/turbo aiming tool models available
- Light-ON/Dark-ON, switch selectable
- Mounting bracket E39-L69 supplied with horizontal sensors
- Mounting bracket E39-L70 supplied with vertical sensors
- Polarized retro--reflective sensors include E39-R1 reflector
- Through-beam sensors include both emitter and receiver
- Pre-wired versions have 2 m cable; M12 4-pin connector versions available



# E3K Photoelectric Sensors

Quick Link  
B242

## Long-range Sensing for Door Control and Material Handling Applications

- AC/DC sensor for heavy-duty switching requirements
- Long sensing distances:
  - Retro-reflective: 10 m, includes E39-R1 reflector
  - Diffuse-reflective: 2 m
- Clean interior, easy-to-wire terminal strip
- Plug-in replaceable relay output
- Timer modules available
- Rated IP67, NEMA 4X, 6 for washdown



### UV Power Monitor for Sterilizing and Curing Operations

- Monitor ultraviolet light (UV) intensity or wavelength to maintain effective levels for critical processes
- Compact monitors fit tight inspection spaces on existing machinery
- Built-in amplifier models detect incident UV light power in two ranges (1 to 30 mW/cm<sup>2</sup> or 0.2 to 3 mW/cm<sup>2</sup>) and provide a 1-5 V analog output
- Fiber-optic detection heads and separate amplifiers detect in two ranges (10 to 300 mW/cm<sup>2</sup> or 30 to 300 mW/cm<sup>2</sup>)
- Fiber-optic monitor available with judgment, answer-back and current/voltage analog outputs



## Long Distance Sensor in Oil-Resistant, Metal Case

- Long sensing distances: 30 m through-beam; 3 m polarized retro-reflective; 2 m or 0.7 m diffuse reflective
- Rugged zinc die cast housing protects against vibration (10 Hz to 2 kHz) and shock (up to approx. 100 G)
- Meets IP67 and NEMA 4X, 6P for water washdown
- High visibility indicators for light incidence and stability
- Light-ON and Dark-ON operation selectable



## Metal Body Sensors

Sensing type	Setup	Features	Light source	Sensing distance	Connection method	Model
Through-beam	 Horizontal	Includes E39-L102 mounting bracket	Infrared (880 nm)	30 m Using E39-S61 slits: 4-mm slit: 15 m 2-mm slit: 7 m 1-mm slit: 3.5 m 0.5-mm slit: 1.8 m	Pre-wired	E3S-CT11
					M12 4-pin connector	E3S-CT16
	 Vertical	Includes E39-L103 mounting bracket			Pre-wired	E3S-CT61
					M12 4-pin connector	E3S-CT66
Retro-reflective	 Horizontal	Polarized; includes E39-R1 reflector and E39-L102 mounting bracket	Red (700 nm)	0 to 3 with E39-R1 reflector (included); Optional reflectors: E39-R2: 0 to 4 m E39-R3: 0 to 150 cm E39-R4: 0 to 75 cm E39-RSA: 5 to 35 cm E39-RSB: 5 to 60 cm	Pre-wired	E3S-CR11
					M12 4-pin connector	E3S-CR16
	 Vertical	Polarized; includes E39-R1 reflector and E39-L103 mounting bracket			Pre-wired	E3S-CR61
					M12 4-pin connector	E3S-CR66
Diffuse reflective	 Horizontal	includes E39-L102 mounting bracket	Infrared (880 nm)	0 to 70 cm	Pre-wired	E3S-CD11
					M12 4-pin connector	E3S-CD16
	 Vertical	Includes E39-L103 mounting bracket			Pre-wired	E3S-CD61
					M12 4-pin connector	E3S-CD66

## E39-L Mounting Brackets

Quick Link  
B299

### Photoelectric Sensor Mounting Brackets

- Brackets enhance mounting flexibility
- Protective mounts fortify sensors
- Height adjustable and rotating mounts available



## E39-R Reflectors

Quick Link  
B298

### Reflectors Return Light to Retro-reflective Photoelectric Sensors and Photomicrosensors

- Corner cube reflectors return maximum light with minimal scattering
- Reflectors extend or shorten sensing distance
- Hard acrylic reflectors are backed by ABS plastic
- Easy-to-apply, adhesive-backed reflectors available
- Sensor data sheets show recommended reflector models



# Photoelectric Sensors

---

## Contents

<b>Selection Guide</b>		J-ii
<b>Fiber-Optic Cables</b>		
<b>E32</b>	Standard Cylindrical Sensor Heads	J-1
<b>E32</b>	Square Shape Sensor Heads	J-2
<b>E32</b>	Miniature Sensor Heads	J-3
<b>E32</b>	Longer Distance Sensor Heads	J-4
<b>E32</b>	Chemical Resistant Sensor Heads	J-5
<b>E32</b>	Heat Resistant Sensing Heads	J-6
<b>E32</b>	Vacuum Resistant Sensor Heads	J-7
<b>E32</b>	Robot Application Heads	J-8
<b>E32</b>	Precision Detection Sensor Heads	J-9
<b>E32</b>	Area Monitoring Sensor Heads	J-10
<b>E32</b>	Special Application Sensor Heads	J-11
<b>E3X-DA-SE-S</b>	Digital Amplifier With One Button Teaching	J-12
<b>E3X-NA/ E3X-SD</b>	Easy To Use Amplifier with Digital or Bar Graph Display	J-13
<b>E3X-DA-S</b>	High Functionality Amplifier	J-14
<b>E3X-MDA</b>	2-in-1 Digital Amplifier	J-15
<b>E3X-NA_F</b>	Fast Response Amplifier	J-15
<b>E3X-HD</b>	High Stability Amplifier	J-16
<b>E3X-DAC-S</b>	Color Mark Detection Amplifier	J-17
<b>E3X-DAH-S</b>	Infrared LED Amplifier	J-17
<b>E3X-ECT/ E3X-CRT/ E3X-DRT21S/ E3X-DRT21/ E3X-CIF11</b>	E3X Communication Units	J-18

J

# Fiber-Optic Amplifiers and Sensors

## The simplicity of high performance in challenging areas

With over 500 different fiber heads we offer one of the most comprehensive fiber portfolios bringing reliable detection to smallest spaces or most challenging environments. The easy usage and auto adjustment features of the fiber amplifiers provide highest stability and performance reducing setup and adjustment times.



**Smaller size:**

Standard cylindrical fiber heads

**E32 Standard cylindrical**

- Easy installation and long sensor lifetime for all general applications
- High flex fibers and 90° models for fiber breakage prevention

**Square housing:**

Through-beam

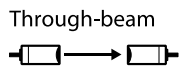

M4

M3

Diffuse-reflective

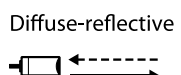

M6

M3

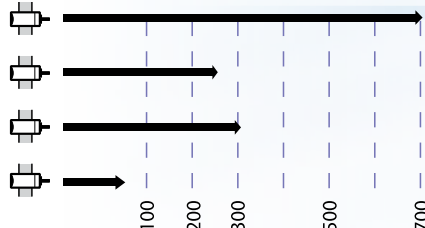

**Longer distance:**

E32 Miniature









E32 Square



E32 Longer distance



## Special Applications

<b>Heat, chemical vacuum resistant</b>	<b>Robotic applications</b>	<b>Area monitoring</b>	<b>Precision detection</b>	<b>Special application</b>
				
<b>E32 Harsh environment</b>	<b>E32 Robot</b>	<b>E32 Area monitoring</b>	<b>E32 Precision</b>	<b>E32 Special</b>
Heat resistant up to 350°C	Robot fiber withstands >1 million bending cycles	Area monitoring up to 70mm beam width	Coaxial or limited reflective models, up to 100µm resolution, variable focal lenses or fine beam	Special solutions for liquid level, color, mark, wafer detections, etc.
				



Digital amplifier dual display

**E3X-DA-SE-S**

- Easy 1-button teaching
- Auto-teaching during operation
- Auto power control for long term stability

Basic functionality:

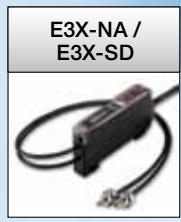

**E3X-DA-S**



High functionality:

**Special Applications**

**2 in 1 double amplifier**

**E3X-MDA**

AND, OR signal  
Infrared LED  
comparison of  
two input signals  
saving space and  
set-up time

**Fast response**

**E3X-NA-F**

Short turn on time  
of 20µs

**High stability**

**E3X-HD**

Simple one button  
setting; detects  
large and low-  
reflection targets;  
light intensity and  
incidence  
compensation for  
stability.

**Color (RGB) amplifier**

**E3X-DAC-S**

White LED and RGB  
ratio comparison for  
challenging color  
and mark detection

**Infrared LED**





**E3X-DAH-S  
Infrared**





Infrared LED



# Selection Table

## Fiber sensors





Type	Cylindrical	Square shape	Miniature	Longer distance	Chemical resistant	Heat resistant
						
Model	E32 Standard cylindrical	E32 Square shape	E32 Miniature	E32 Longer distance	E32 Chemical resistant	E32 Heat resistant
Key features	<ul style="list-style-type: none"> <li>• Standard and high-flex fibers</li> <li>• Sizes M3 to M6</li> </ul>	<ul style="list-style-type: none"> <li>• 3 or 4 mm thin housing</li> <li>• Models in X,Y or Z-axis</li> <li>• Direct mounting without bracket</li> </ul>	<ul style="list-style-type: none"> <li>• Sizes from 500 µm to 3 mm dia</li> <li>• Bendable sleeves</li> </ul>	<ul style="list-style-type: none"> <li>• Built in focal lenses</li> </ul>	<ul style="list-style-type: none"> <li>• Fluoroplastic cover or coating</li> </ul>	<ul style="list-style-type: none"> <li>• Heat resistant up to 400°C</li> </ul>
Through-beam	760 mm	760 mm	750 mm	20 m	3 m	1.3 m
Retro-reflective	250 mm	–	–	–	–	–
Diffuse-reflective	300 mm	300 mm	300 mm	700 mm	170 mm	280 mm





Type	Vacuum resistant	Robot applications	Precision detection	Area monitoring	Special application
					
Model	E32 Vacuum resistant	E32 Robot	E32 Precision detection	E32 Area monitoring	E32 Special
Key features	<ul style="list-style-type: none"> <li>• Leakage rate of <math>1 \times 10^{-10}</math> Pa*m<sup>3</sup>/s max</li> </ul>	<ul style="list-style-type: none"> <li>• Free moving multicore fibers for &gt;1 Mio bending cycles</li> </ul>	<ul style="list-style-type: none"> <li>• Detection accuracy up to 100 µm</li> <li>• Coaxial fibers</li> <li>• Adjustable focal points</li> </ul>	<ul style="list-style-type: none"> <li>• Area monitoring up to 70 mm beam width</li> </ul>	<ul style="list-style-type: none"> <li>• Detection of special objects (wafer, liquid level, flat glass, print mark,..)</li> </ul>
Through-beam	480 mm	680 mm	1.9 m	2.8 m	1.9 m
Retro-reflective	–	–	–	–	–
Diffuse-reflective	–	170 mm	300 mm	150 mm	300 mm

Note: All sensing distances measured with E3X-DA-SE-S. Longer sensing distances up to 80% can be achieved with E3X-DA-S.

# Fiber-Optic Amplifiers and Sensors

## Fiber optic amplifiers

Type	Easy teach	Potentiometer adjuster	High functionality	Double amplifier
				
Model	E3X-DA-SE-S	E3X-NA, E3X-SD	E3X-DA-S	E3X-MDA
Key features	<ul style="list-style-type: none"> <li>• 1 button object teaching</li> <li>• Auto teach during operation</li> </ul>	<ul style="list-style-type: none"> <li>• Easy adjustment by potentiometer</li> <li>• Bar graph gain display (-NA)</li> </ul>	<ul style="list-style-type: none"> <li>• High functionality signal processing (timer, counter, power tuning, etc.)</li> <li>• Up to 80% longer sensing distances</li> </ul>	<ul style="list-style-type: none"> <li>• 2 inputs and AND, OR signal comparison</li> </ul>
Response time (min.)	1 ms	200 $\mu$ s	1 ms (80 $\mu$ s in high speed mode)	1 ms (130 $\mu$ s in high speed mode)

Type	High speed	High Stability	Color/print mark detection	Infrared LED
				
Model	E3X-NA-F	E3X-HD	E3X-DAC-S	E3X-DAH-S
Key features	<ul style="list-style-type: none"> <li>• Short turn on time of 20 <math>\mu</math>s</li> </ul>	<ul style="list-style-type: none"> <li>• Accurately detects large and low reflection targets</li> <li>• Simple 1 button setting</li> <li>• Compensates for light reduction from grime, deterioration</li> </ul>	<ul style="list-style-type: none"> <li>• White LED and RGB ratio comparison</li> </ul>	<ul style="list-style-type: none"> <li>• Infrared LED</li> </ul>
Response time (min.)	20 $\mu$ s	1 ms (50 $\mu$ s in super high speed)	1 ms (60 $\mu$ s in super high speed)	1 ms (55 $\mu$ s in super high speed)

J

# Fiber-Optic Sensors

---

## Standard Cylindrical Sensor Heads

The standard cylindrical fiber optic sensing heads provide reliable object detection, easy installation and long sensor lifetime for all general applications.



- High-flex fibers and 90° cable exit reduce fiber breakage
- Models with hexagonal back for simplified one-nut mounting
- Sizes M3 to M6

Sensor type	Size	Sensing distance (mm) <sup>1</sup>		Model	
		Standard	High-flex Fiber	Standard Fiber	High-flex
 Through Beam	M4	760	530	E32-TC200	E32-ET11R
	M3	220	130	E32-TC200E	E32-ET21R
 Through Beam	M4	—	530	—	E32-T11N 2M
 Retro-Reflective	M6	250 <sup>2</sup>	—	E32-R21	—
 Diffuse Reflective	M6	300	170	E32-DC200	E32-ED11R 2M
	M4	80	30	E32-D211 2M	E32-D211R 2M
	M3	80	30	E32-DC200E	E32-ED21R 2M
 Diffuse Reflective	M6	—	170	—	E32-D11N 2M
 Diffuse Reflective	6 mm dia	110	45	E32-D14L	E32-D14LR

<sup>1</sup> Sensing distance measured with E3X-DA-SE-S family. Longer sensing distance up to 80% can be achieved with E3X-DA-S.

<sup>2</sup> Measured with E39-R3 reflector



Hi-flex multicore fibers for flexibility in installation without fiber breakage



Models with hexagonal back for simple one-nut mounting

## Square Shape Sensor Heads

The fiber heads in square shaped housing provide fast and easy installation on flat surfaces.

- Models with sensing direction in X, Y or Z axis
- 3 or 4 mm thick housings for minimal height requirement
- Standard or high-flex fibers



Sensor type	Size (mm)	Sensing distance (mm) <sup>1</sup>		Model	
		Standard Fiber	High-flex Fiber	Standard Fiber	High-flex Fiber
Through Beam	15 x 8 x 3	760	560	E32-T15X 2M	E32-T15XR 2M
Through Beam	15 x 8 x 3	460	210	E32-T15Y 2M	E32-T15YR 2M
Through Beam	15 x 8 x 3	460	480	E32-T15Z 2M	E32-T15ZR 2M
Diffuse Reflective	15 x 10 x 3	300	170	E32-D15X 2M	E32-D15XR 2M
Diffuse Reflective	15 x 10 x 3	100	40	E32-D15Y 2M	E32-D15YR 2M
Diffuse Reflective	15 x 10 x 3	100	60	E32-D15Z 2M	E32-D15ZR 2M
Through Beam	24.5 x 10 x 3	890	—	E32-A03-1 2M	—
	20.5 x 2 x 2	340	—	E32-A04-1 2M	—

<sup>1</sup> Sensing distance measured with E3X-DA-SE-S family. Longer sensing distance up to 80% can be achieved with E3X-DA-S. Amplifier

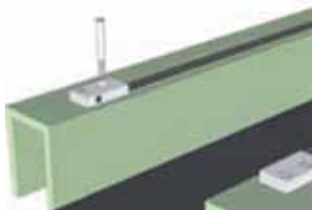

Space saving and fast mounting without additional brackets









Precise positioning during manufacturing for 90° optics to achieve minimal tolerance variations in optical output axis angle

## Miniature Sensor Heads

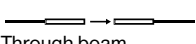
The miniature fiber heads provide high accuracy in smallest spaces and reliable detection of miniature objects.

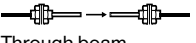
- Sizes from 500  $\mu\text{m}$  diameter to 3 mm diameter
- Side view models with precision axis alignment for highest accuracy
- Bendable sleeves for precision positioning

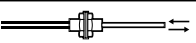

Sensor type	Size	Sensing distance (mm) <sup>1</sup>		Model	
		Standard Fiber	High-flex Fiber	Standard Fiber	High-flex Fiber
 Through beam	3 mm dia	750	530	E32-T12	E32-T12R
	2 mm dia	220	130	E32-T22	E32-T22R
	1.5 mm dia	220	130	E32-T222	E32-T222R
	1 mm dia	—	130	—	E32-T223R
 Through beam	3 mm dia	460	210	E32-T14L	E32-T14LR
	2 mm dia	340	—	E32-A04	—
 Through beam	1 mm dia	130	50	E32-T24	E32-T24R
 Through beam	1.2 mm dia	750	530	E32-TC200B	E32-TC200BR
	0.9 mm dia	220	130	E32-TC200F	E32-TC200FR
 Diffuse reflective	3 mm dia	80	30	E32-D22	E32-D22R
	2 mm dia	75	40	E32-D32	E32-D32R
	1.5 mm dia	—	30	—	E32-D22B
 Diffuse reflective	2 mm dia	30	15	E32-D24	E32-D24R
 Diffuse reflective	2.5 mm dia	300	170	E32-DC200B <sup>3</sup>	E32-DC200BR <sup>3</sup>
	1.2 mm dia	80	30	E32-DC200F	E32-DC200FR
 Diffuse reflective	0.8 mm dia	—	16	—	E32-D33
	0.5 mm dia	—	3	—	E32-D331

<sup>1</sup> Sensing distance measured with E3X-DA-SE-S family. Longer sensing distance up to 80% can be achieved with E3X-DA-S.

<sup>2</sup> Models with 40 mm sleeve instead of 90 mm sleeve are available by adding '4' to the order code at the end, e.g. E32-TC200B4

<sup>3</sup> Sleeve cannot be bent

## Longer Distance Sensor Heads

With built-in focal lenses the longer distance fiber heads provide enhanced operational stability in dusty environments or long distance applications



- Sensing distance up to 20 m
- Built-in focal lens
- Sizes from 2 mm dia to M14 dia

Sensor type	Size	Sensing distance (mm) <sup>1</sup>	Model
Through beam	M14	20000	E32-T17L
Through beam	25.2 x 10.5 x 8 mm	3400	E32-T14
Through beam	M4	1330	E32-T11L
	M3	680	E32-TC200A
Through beam	3 mm dia	1330	E32-T12L
	2 mm dia	440	E32-T22L
Convergent-reflective	21.4 x 27 x 10 mm	1500 <sup>2</sup>	E32-R16
Diffuse reflective	22 x 17.5 x 9 mm	700	E32-D16
Diffuse reflective	M6	400	E32-D11L
	M4	130	E32-D21L
Diffuse reflective	3 mm dia	450	E32-D12

<sup>1</sup> Sensing distance measured with E3X-DA-SE-S family. Longer sensing distance up to 80% can be achieved with E3X-DA-S.

<sup>2</sup> Measured with E39-R1

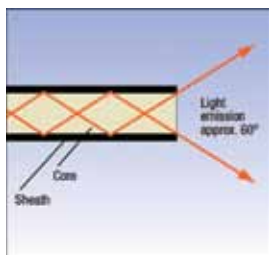

Light emission of conventional fibers

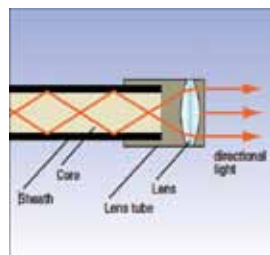

With built-in focal lenses, longer sensing distances can be achieved up to 5 times longer compared to conventional sensors

## Chemical Resistant Sensor Heads

The chemical resistant fibers provide long sensor lifetime in areas with frequent cleaning, usage of chemicals and higher temperatures.

- Fluororesin cover for highest chemical resistance
- Temperature resistance up to 200°C



Sensor type	Size	Sensing distance (mm) <sup>1</sup>	Cover material	Model
Through beam	M4	680	Fluororesin coating	E32-T11U
Through beam	5 mm dia	3,000	Fluororesin cover	E32-T12F
Through beam	5 mm dia	1,400	Fluororesin cover	E32-T14F
Diffuse reflective	M6	170	Fluororesin coating	E32-D11U
Diffuse reflective	6 mm dia	85	Fluororesin cover	E32-D12F
Diffuse reflective	6 mm dia	40	Fluororesin cover	E32-D14F
Through beam	6 mm dia	700	Fluororesin cover Heat resistant to 200°C	E32-T81F-S
Through beam	5 mm dia	3,000	Fluororesin cover Heat resistant to 150°C	E32-T51F

<sup>1</sup> Sensing distance measured with E3X-DA-SE-S family. Longer sensing distance up to 80% can be achieved with E3X-DA-S.



Enhanced temperature resistant models

The fluororesin cover provides highest chemical resistance for longest lifetime in frequently cleaned environments like aseptic filling in pharmaceutical applications



## Heat Resistant Sensor Heads

The wide range of heat resistant fibers provides long sensor lifetime with highest protection in demanding environments

- Heat resistant up to 400°C
- Sizes from 2 mm dia to M6
- Models for long distances or high detection accuracy



Sensor type	Size	Sensing distance (mm) <sup>1)</sup>	Temperature Range	Model	
				For E3X-DA-S teachable amplifier	For E3X-NA amplifier with potentiometer adjustment
 Through beam	M4	450	-40°C to 150°C	E32-T51	
	M4	280	-40°C to 200°C	E32-T81R-S	
	M4	450	-60°C to 350°C	E32-T61-S	
 Through beam	2 mm dia	230	-40°C to 150°C	E32-T54	
 Through beam	3 mm dia	1300	-40°C to 200°C	E32-T84S-S	
 Diffuse reflective	M6	230	-40°C to 150°C	E32-D51	
	M6	280	-40°C to 200°C	E32-D81R-S	E32-D81R
 Diffuse reflective	M6	150	-60°C to 350°C	E32-D61-S	E32-D61
 Diffuse reflective	M4	60	-40°C to 400°C	E32-D73-S	E32-D73
 Diffuse reflective	23 x 20 x 9 mm	35	-40°C to 150°C	E32-A09H	
	30 x 24 x 9 mm	25	-40°C to 300°C	E32-A09H2	
 Diffuse reflective	25 x 18 x 5 mm	5	-40 to 300°C	E32-L64	
	36 x 18 x 5 mm	18		E32-L66	

<sup>1)</sup> Sensing distance measured with E3X-DA-SE-S family. Longer sensing distance up to 80% can be achieved with E3X-DA-S.

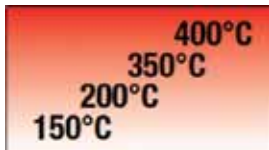

The temperature range optimized material selection provides best application fit and value - performance ratio.



Stainless steel spiral coating for flexibility with highest mechanical protection.

## Vacuum Resistant Sensor Heads

For applications in cleanest and hot environments the vacuum resistant fibers and connecting flanges provide long operational lifetime and vacuum integrity.

- Leakage rate of  $1 \times 10^{-10}$  Pa·M<sup>3</sup>/s max
- Heat resistance up to 200°C
- Detergent resistant fluoro-resin or stainless steel fiber sheath



## Sensor

Sensor type	Size	Sensing distance (mm) <sup>1</sup>	Temperature Range	Model
Through beam	M4	200	-40°C to 120°C	E32-T51V 1M
Through beam	3 mm dia	130	-40°C to 120°C	E32-T54V 1M
	3 mm dia	480	-60°C to 200°C	E32-T84SV 1M
Through beam	33 x 18 x 3 mm dia	5	-40°C to 70°C	E32-G86V-13M

<sup>1</sup> Sensing distance measured with E3X-DA-SE-S family. Longer sensing distance up to 80% can be achieved with E3X-DA-S.

## Flange

Type	Size	Model
4 channel flange	80 x 80 x 49 mm	E32-VF4
1 channel flange	96 x 30 dia mm max.	E32-VF1
Flange-to-amplifier connection fiber	2 m length	E32-T10V 2M

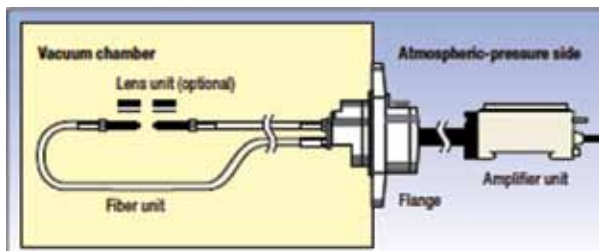





The vacuum resistant fiber heads and flanges are sealed to prevent gas leakage into vacuum areas

## Robot Application Sensor Heads

For applications on frequently or fast moving parts, the robot fibers reduce the risk of fiber breakage with a guaranteed operational life of more than 1 million bending cycles

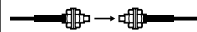
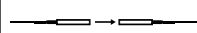
- Free moving multicore fibers for more than 1 million bending cycles
- Square shapes for easy surface installation
- Cylindrical sizes from 1.5 mm dia to M6

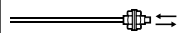

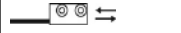
Sensor type	Size	Sensing distance (in mm) <sup>1</sup>	Model
 Through beam	M4	680	E32-T11
	M3	200	E32-T21
 Through beam	3 mm dia	680	E32-T12B 2M
	2 mm dia	200	E32-T221B 2M
	1.5 mm dia	200	E32-T22B
 Through beam	15 x 18 x 3 mm	680	E32-T15XB
 Diffuse reflective	M6	170	E32-D11
	M4	70	E32-D21B
	M3	30	E32-D21
 Diffuse reflective	1.5 mm dia	30	E32-D22B
 Diffuse reflective	15 x 10 x 3 mm	170	E32-D15XB 2M

<sup>1</sup> Sensing distance measured with E3X-DA-SE-S family. Longer sensing distance up to 80% can be achieved with E3X-DA-S.

## Precision Detection Sensor Heads

Highest precision in design and manufacturing of the fibers and focal lenses ensure highest beam and spot accuracy allowing the detection of smallest objects and height differences of less than 100  $\mu\text{m}$ .



- Coaxial fibers with focal lenses for spot diameters of 100  $\mu\text{m}$
- Through-beam models with highly focused beam and precise optical axis alignment
- Limited reflective models for height difference detection of less than 100  $\mu\text{m}$

Sensor type	Preferred usage	Size	Key feature	Sensing distance (mm) <sup>1</sup>	Model
Through beam	Precise thin object detection / accurate positioning	3 mm dia	- High precision optical axis adjustment - Very focused beam	1900	E32-T22S
Through beam		3 mm dia		890	E32-A03 2M
Through beam		3 mm dia		340	E32-A04 2M
Diffuse reflective	Very small object detection	M6	—	300	E32-CC200 <sup>2</sup>
		M3	Spot dia 0.5 mm	20	E32-EC31 2M
		M3	Spot dia 0.2 mm	17	E32-EC41 1M + E39-F3B
		M3	Spot dia 0.1 mm	7	E32-EC41 1M + E39-F3A-5
Diffuse reflective		3 mm dia	—	150	E32-D32L
		2 mm dia	—	75	E32-D32 <sup>2</sup>
Diffuse reflective		M6	- 90° cable exit - Hexagonal back	170	E32-C11N 2M
		M3		25	E32-C31N 2M
Diffuse reflective		M3	Small spot	8-25 m adjustable	E32-EC31 2M + E39-EF51
		2 mm dia	Spot dia 0.5 to 1 mm	6-15 mm adjustable	E32-D32 + E39-F3A
	2 mm dia	Spot dia 0.1 to 0.6 mm	6-15 mm adjustable	E32-C42 + E39-F3A	
Diffuse reflective	Precision height difference detection / flat surface detection	23 x 20 x 9 mm	—	35	E32-A09 2M
Convergent-reflective		16 x 18 x 4 mm	—	7.2	E32-L25L <sup>2</sup>
		20 x 20 x 5 mm	—	3.3	E32-L25
Diffuse reflective		18 x 20 x 4 mm	Precise spot e.g. for detection of a flat / reflective surface	4	E32-L24L <sup>2</sup>
		34 x 25 x 8 mm	High precision (detection accuracy 100 $\mu\text{m}$ )	2.4	E32-EL24-1 2M
Diffuse reflective	Object detection in front of background	20.5 x 14 x 3.8 mm	Wide beam e.g. for object detection on a flat surface	15	E32-L16-N 2M

<sup>1</sup> Sensing distance measured with E3X-DA-SE-S family. Longer sensing distance up to 80% can be achieved with E3X-DA-S.

<sup>2</sup> A high flex cable version is available. Add 'R' to the order code, e.g. E32-CC200R

## Area Monitoring Sensor Heads

The area monitoring fibers allow the detection of objects passing anywhere through the detection range and can be used for height comparisons of different objects.

- Area monitoring up to 70 mm height
- Multi-beam sensor with 4 separate heads for flexible detection points
- Standard or high flex fibers



Sensor type	Area height (mm)	Sensing distance (mm) <sup>1</sup>		Model	
		Standard Fiber	High-flex Fiber	Standard Fiber	High-flex Fiber
Through beam	10	2800	–	E32-T16	–
Through beam	11	1100	840	E32-T16P	E32-T16PR
Through beam	30	1800	1300	E32-T16W	E32-T16WR
	50	–	1800	–	E32-ET16WR-2
	70	–	2000	–	E32-ET16WR-1
Through beam	11	1000	750	E32-T16J	E32-T16JR
Through beam	4 separate M3 heads	610	–	E32-M21	–
Diffuse reflective	11	–	150	–	E32-D36P1

<sup>1</sup> Sensing distance measured with E3X-DA-SE-S family. Longer sensing distance up to 80% can be achieved with E3X-DA-S.



The two outputs of the E3X-DA-S can be used to detect two different light levels

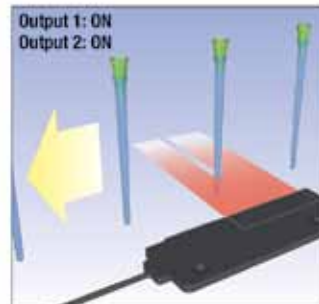
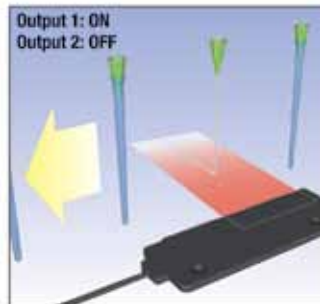

In combination with the twin output function of the E3X-DA-S amplifier, the diffuse reflective area monitoring fibers can detect very small objects (e.g. needles) and a second state (e.g. cover present). The area beam compensates for position variations at high speed.

## Special Application Sensor Heads

For a wide range of special applications, the task optimized fiber heads provide best fitting sensing performance and adaptation to environmental requirements.



- Detection of special objects (liquids, labels on foils, etc.)
- Fiber heads ideal for color mark detection
- Fiber heads optimized for special tasks (wafer mapping, flat glass, etc.)

Sensor type		Size	Sensing distance (mm) <sup>1</sup>	Comment	Model
Through beam	Fork shape	36 x 24 x 8 mm	10	–	E32-G14
Through beam	Wafer mapping	3 mm dia	1900	–	E32-T22S
		3 mm dia	1300	–	E32-T24S
		3 mm dia	890	–	E32-A03 2M
		2 mm dia	340	–	E32-A04 2M
Diffuse reflective	Liquid level sensor	6 mm dia	Liquid contact	Liquid level contact	E32-D82F1
		15 x 23.5 x 5 mm	Tube contact	Liquid level detection through transparent tube or container	E32-D36T 2M
Diffuse reflective	Glass detection	21 x 16.5 x 4 mm	8 mm	Metal housing	E32-A10 2M
		20.5 x 14 x 3.8 mm	15 mm	Plastic housing	E32-L16-N 2M
	Glass detection in hot environment	25 x 18 x 5 mm	5 mm	Heat resistant up to 300°C	E32-L64
		36 x 18 x 5.5 mm	18 mm		E32-L66
Convergent-reflective	Glass detection in wet processes	38.5 x 39 x 17.5 mm	8 to 20 (recommended: 11 mm)	- Heat resistant up to 85°C - Recommended usage with 'tough mode' of E3X-DA-S	E32-L11FS 2M
Convergent-reflective / Diffuse reflective	Label detection	20 x 20 x 5 mm	7.2	–	E32-L25L
		18 x 20 x 4 mm	4	–	E32-L24L
		34 x 25 x 8 mm	2.4	Very precise spot (detection accuracy 100 µm)	E32-EL24-1
Diffuse reflective	Color/ print mark detection	M6	300	Recommended for standard color and color mark detection	E32-CC200
		29 x 25.5 x 11.2	55	Recommended for challenging color and color mark detection	E32-L15 2M
			23 x 20 x 9 mm		35
		M3	20	Recommended for very precise color mark detection	E32-EC31 2M

<sup>1</sup> Sensing distance measured with E3X-DA-SE-S family. Longer sensing distance up to 80% can be achieved with E3X-DA-S.

## Digital Amplifier With One Button Teaching

E3X-DA-SE-S allows easy one button setting and provides the best value to performance ratio for standard applications.

- Auto-teaching during machine operation
- Digital dual display for incident level and threshold
- Object or 2-point teaching within a few seconds



## Amplifier

Item	Model	
	NPN output	PNP output
Pre-wired	E3X-DA11SE-S	E3X-DA41SE-S
Fiber amplifier connector <sup>**1</sup>	E3X-DA6SE-S	E3X-DA8SE-S

<sup>\*\*1</sup> Order connector separately.

## Fiber Amplifier Connectors

Shape	Type	Comment	Model
	Fiber amplifier connector	2 m PVC cable	E3X-CN21
		30 cm PVC cable with M12 plug connector (4 pin)	E3X-CN21-M1J 0.3M
		30 cm PVC cable with M8 plug connector (4 pin)	E3X-CN21-M3J-2 0.3M

<sup>\*\*1</sup> Order connector separately. For M8 connector models see E3X-DA-S.



### 1-button auto-teaching

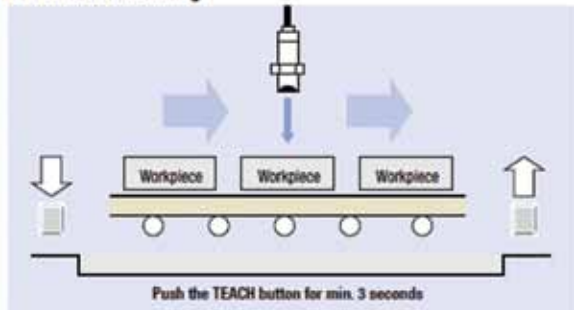

### 2-point teaching

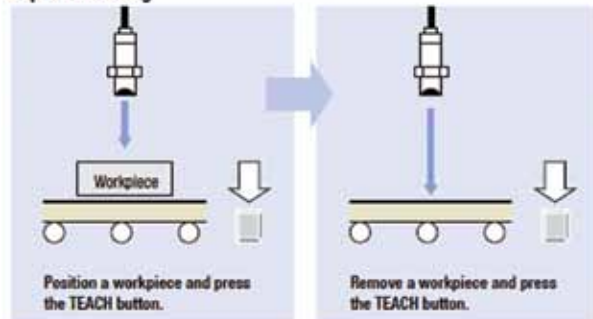

# E3X-NA Fiber-Optic Sensors

Quick Link  
B328

## Simple, Easy-to-Read Amplifier with Bar Graph Display

- Streamlined features provide basic sensing immediately after plug-in
- Easy push button teach with or without workpiece
- Pre-wired (2 m cable) and wire-saving connector models available
- IP66 water-resistant models available



## Ordering Information

Type	Item	Model	
		NPN output	PNP output
Pre-wired (2 m)	Standard	E3X-NA11	E3X-NA41
Pre-wired (2 m)	Enhanced water resistance	E3X-NA11V 2M	E3X-NA41V 2M
Connector	Standard (fiber amplifier connector) <sup>*1</sup>	E3X-NA6	E3X-NA8
Connector	Enhanced water resistance (M8 4-pin connector)	E3X-NA14V	E3X-NA44V

<sup>\*1</sup> Order connector separately, see E3X-DA-S.

# E3X-SD Fiber-Optic Sensors

Quick Link  
B334

## High Performance Amplifier with Digital Display

- Large, 6 mm wide digital display provides read-out of incident and operating level
- Incident settings and management can be performed reliably with fine tune adjustment
- Connectivity for up to 16 amplifiers
- Rated IP50



## Ordering Information

Type	Item	Model	
		NPN output	PNP output
Pre-wired (2 m)	Standard	E3X-SD21 2M	E3X-SD51 2M
Connector	Standard (fiber amplifier connector) <sup>*1</sup>	E3X-SD6	E3X-SD8

<sup>\*1</sup> Order connector separately, see E3X-DA-S.



## High Functionality Digital Amplifier

High functionality digital fiber amplifier with advanced timing, LED power control and signal processing functionality providing highest detection accuracy and stability even for the most challenging objects and settings.

- Power tuning function to adjust the received light to a maximum, minimum or pre-defined value
- Auto power and threshold adjustment functions for highest operational stability
- Two outputs for window monitoring or two level detections (e.g. object + object state change)



Item	Function								Model	
	Power Tuning	Timer	Auto-threshold compensation (ATC)	Twin output	External input	Differential operation	Wet process 'tough mode'	Power saving 'Eco' functions (display/LED off)	NPN output	PNP output
Pre-wired	Yes	Yes	Yes	Yes	Yes	Yes	Yes	Yes	E3X-DA21-S 2M	E3X-DA51-S 2M
Fiber amplifier connector <sup>**1</sup>	Yes	Yes	Yes	Yes - selectable	Yes	Yes	Yes	Yes	E3X-DA7-S	E3X-DA9-S

<sup>\*\*1</sup> Order E3X-CNxx connector separately below.

## Wire-saving Connectors

Item	Cable length	Number of conductors	Function	Compatible sensor amplifiers	Model
Master connector	2 m	3	First amplifier, with power line	E3X-DA7F-S, E3X-DA9F-S, E3X-DA6SE-S, E3X-DA8SE-S, E3X-DA6-S, E3X-DA8-S, E3X-DAG6-S, E3X-DAG8-S, E3X-DAB6-S, E3X-DAB8-S, E3X-DAH6-S, E3X-DAH8-S, E3X-DAC6-S, E3X-DAC8-S, E3X-SD6, E3X-SD8, E3X-NA6, E3X-NA8	E3X-CN11
Slave connector		1	Second and subsequent amplifiers		E3X-CN12
Master connector		4	First amplifier, with power line	E3X-DA7-S, E3X-DA9-S, E3X-DA6TW-S, E3X-DA8TW-S, E3X-DA6RM-S, E3X-DA8RM-S, E3X-DA6AT-S, E3X-DA8AT-S, E3X-MDA6, E3X-MDA8	E3X-CN21
Slave connector		2	Second and subsequent amplifiers		E3X-CN22
Cordless slave connector	–	–	Use with amplifiers connected to a communication interface unit	E3X-HD0, E3X-DA0-S, E3X-MDA0	E3X-CN02

# E3X-MDA Fiber-Optic Sensors



## 2-in-1 Digital Amplifier

E3X-MDA incorporates 2 digital fiber amplifiers in one slimline housing. For applications requiring the detection of two objects simultaneously the E3X-MDA provides an easy to use operation saving space and set-up time.



- Two digital amplifiers in one slimline housing
- Twin output models – on/off or area (between two threshold values)
- Signal comparison functions (AND, OR, etc.)

Item	Function	Model	
		NPN output	PNP output
Pre-wired	AND/OR output	E3X-MDA11	E3X-MDA41
Fiber amplifier connector <sup>*1</sup>	AND/OR output	E3X-MDA6	E3X-MDA8
Communication model	AND/OR output	E3X-MDA0	

<sup>\*1</sup> Order E3X-CNxx connector separately, see E3X-DA-S.

J

# E3X-NA□F Fiber-Optic Sensors



## Fast response digital amplifier with potentiometer

The E3X-NA\_F provides a very fast response time and is the ideal amplifier for high speed detection applications.



- Short turn on time of only 20 μs
- Easy adjustment with potentiometer

Shape	Model	
	NPN output	PNP output
Pre-wired	E3X-NA11F	E3X-NA41F 2M

## High Stability Amplifier with Simple Setting

Fiber-optic amplifier provides ultra-stable performance and smart tuning for high-speed, reliable input to open protocol industrial networks.

- Simple one-button smart tuning for sensor threshold and light intensity
- Confirm settings, status with dual display and indicators on control buttons
- Automatic compensation for large objects and low reflectance dark targets
- Smart power control function compensates for grime build-up and LED deterioration



- EtherCAT and CompoNet high-speed open network communication interfaces available

## Sensor Amplifiers

Item	Maximum connectable units	Connection method	NPN output model	PNP output model
Standard models	16 units	Pre-wired, 2 m cable	E3X-HD11 2M	E3X-HD41 2M
	16 units	Wire-saving connector	E3X-HD6	E3X-HD8
Network models	16 units (E3X-CRT CompoNet); 30 units (E3X-ECT EtherCAT)	Communications unit	E3X-HD0	

## Wire-saving Connectors

Item	Cable length	Number of conductors	Function	Model
Master connector	2 m	3	First amplifier, with power line	E3X-CN11
Slave connector		1	Second and subsequent amplifiers	E3X-CN12
Cordless slave connector	–	–	Use with amplifiers connected to a communication interface unit	E3X-CN02

## Communication Interface Units

Network type	Applicable Fiber Amplifiers	Model
CompoNet	E3X-HD0, E3X-MDA0, E3X-DA0-S	E3X-CRT
EtherCAT		E3X-ECT

# E3X-DAC-S Fiber-Optic Sensors

Quick Link  
B325

## E3X-DAC-S Color (RGB) Digital Fiber Amplifier

The E3X-DAC-S detects the color and returned light intensity of a mark or object and compares it with a stored RGB ratio or intensity value. The RGB ratio or contrast difference allows the stable detection of differently colored, black, grey or white marks or objects.



- White LED for color independence
- Fast response time of 60  $\mu$ s
- Timer function for variable ON or OFF delay up to 5 seconds
- Remote teaching or easy one-button teaching

### Pre-wired

Item	Functions	Model (for pre-wired types with 2 m cable length)	
		NPN output	PNP output
Standard models	Timer, response speed change	E3X-DAC11-S 2M	E3X-DAC41-S 2M
Advanced models	Standard models + simultaneous determination (2 colors) AND/OR output, remote setting	E3X-DAC21-S 2M	E3X-DAC51-S 2M

### Connector Versions

Item	Functions	Model	
		NPN output	PNP output
Standard models (fiber amplifier connector) **	Timer, response speed change	E3X-DAC6-S	E3X-DAC8-S

\*\* Order connector separately, see E3X-DA-S.

# E3X-DAH-S Fiber-Optic Sensors

Quick Link  
B338

## Digital Amplifier with Infrared LED

The digital fiber amplifiers with infrared LED are ideal for water detection applications or where visible light is not desired.



- Infrared LED
- LED power control and signal processing function

### Pre-wired

Item	Model (for pre-wired types with 2 m cable length)	
	NPN output	PNP output
Infrared light	E3X-DAH11-S	E3X-DAH41-S

### Connector Versions

Item	Model	
	NPN output	PNP output
Infrared light (fiber amplifier connector) **	E3X-DAH6-S	E3X-DAH8-S

\*\* Order connector separately, see E3X-DA-S.

### Reduced Wiring Solution to Interface with Open Communication Networks

Build efficient sensor input slave blocks using E3X Communication Interface Units and multiple E3X sensors. This solution reduces wiring, saves space and shortens setup time.



- EtherCAT, CompoNet, DeviceNet and serial communication units available
- Connect up to 16 fiber-optic sensors to each unit (up to 30 with EtherCAT)
- Supports explicit message communications
- Use E3X-CN02 Cordless Slave Connector for each sensor
- Remote setting, monitoring and operating through CX-Integrator software
- Mobile Programming Console for simple setting and monitoring locally

### Network Communication Interface Units

Network type	Maximum connectable amplifiers	Compatible sensor amplifiers	Model
EtherCAT	30 units	E3X-HD0, E3X-MDA0, E3S-DA0-S	E3X-ECT
CompoNet	16 units	E3X-HD0, E3X-MDA0, E3S-DA0-S	E3X-CRT
DeviceNet	16 units	E3X-DA7-S, E3X-DA9-S, E3X-DA6-S, E3X-DA8-S, E3X-DAG6-S, E3X-DAG8-S, E3X-DAB6-S, E3X-DAB8-S, E3X-DAH6-S, E3X-DAH8-S, E3X-DA6RM-S, E3X-DA8RM-S, E3X-DA6TW-S, E3X-DA8TW-S, E3X-DA6AT-S, E3X-DA8AT-S, E3X-MDA6, E3X-MDA8, E3C-LDA11, E3C-LDA41, E2C-EDA11, E2C-EDA41	E3X-DRT21S
	16 units	E3X-DA6, E3X-DA8, E3X-DAB6, E3X-DAB8, E3X-DAG6, E3X-DAG8, E3X-DA6TW, E3X-DA8TW, E3X-DA6-P	E3X-DRT21 SVER3
Serial RS-422	16 units	E3X-DA6, E3X-DA8, E3X-DAB6, E3X-DAB8, E3X-DAG6, E3X-DAG8, E3X-DA6TW, E3X-DA8TW, E3X-DA6-P	E3X-CIF11

### Connector

Item	Function	Model
Cordless slave connector	Replaces individual cabling for network communications	E3X-CN02

### Mobile Console

Item	Description	Function	Model
Mobile console set	Mobile console with programming head, cable, and AC adapter	Set, teach and fine-tune one or a group of amplifiers simultaneously; copy settings from one amplifier to another within the same group or to a group on another machine; set mode lockout to limit access; monitor/troubleshoot operation	E3X-MC11-SV2

For additional information, use Quick Link Code **B324**, select E3X-DA-S brochure.

## Contents

<b>Selection Guide</b>		K-ii
<b>Slotted</b>		
EESX91□	Ultra-small, pre-wire 5 mm slot sensors	K-1
EE-SX77□/ EE-SX87□	Thin profile, pre-wired 5 mm slot sensors	K-2
EE-SX47□/ EESX-67□	Plug-in or pre-wired slotted sensors	K-3
EE-SX97□	Plug-in slot sensors with reduced mounting depth	K-5
EE-SPX74□/ EE-SPX84□	Plug-in light modulated slot sensors	K-6
EE-SPX301/ 401	Plug-in 3.6 mm slot sensors	K-7
EE-SPX-W2A	Pre-wired light modulated slot sensors	K-8
EE-SPX303N/ EE-SPX403N	Plug-in 13 mm slot sensors	K-9
<b>Reflective</b>		
EE-SPY31□/ EE-SPY-41□	Reflective plug-in sensors	K-10
EE-SY671/ EE-SY672	Adjustable sensitivity reflective plug-in sensors	K-11
EE-SPY301/ 302/401/402	Reflective sensors with plug-in/solder terminals	K-7
<b>Through-Beam</b>		
EE-SPW311/ 411	Long-distance miniature built in amp	K-12
EE-SPW321/ 421	Miniature sensing heads with in-line cable amplifier	K-13
<b>Special Application</b>		
EE-SPX613	Liquid level sensor	K-14
EE-SPZ-A	Retro-reflective sensor	K-15
EE-SA701/ 801	Pushbutton actuator sensors	K-16
EE-SPY801/ 802	Water carrier mounting sensor	K-17

## SMALL SENSORS DELIVER PRECISE POSITIONING

Continuous miniaturization of robots and machinery for semiconductor, photovoltaic and electronics manufacturing require increasingly precise positioning data to maximize production yield and maintain high quality. Amplified photomicrosensors deliver high precision in a simply mounted format. Embed them in rails for robots, X-Y positioning tables and conveyors for end-of-travel and home position inputs. All are designed for easy connection to PLCs and other controllers as part of a motion control solution.



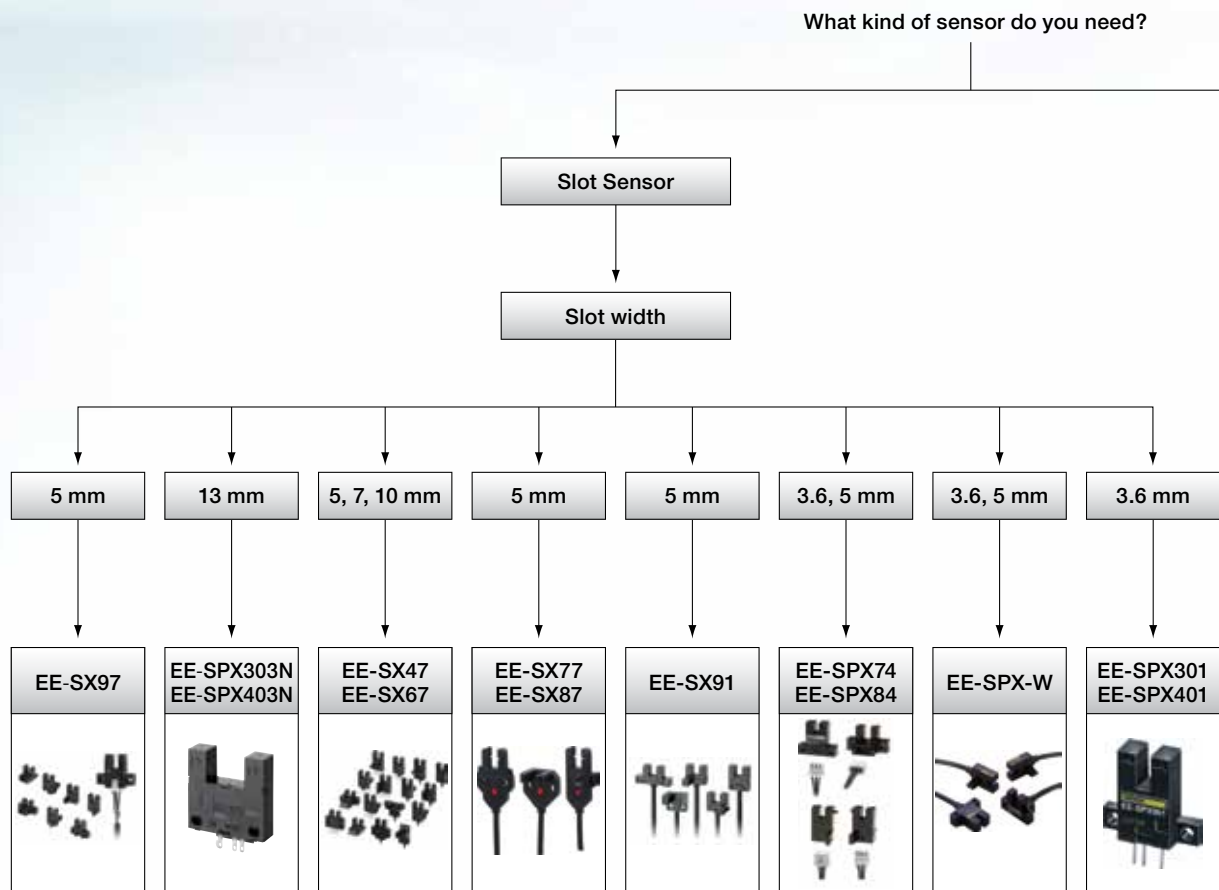

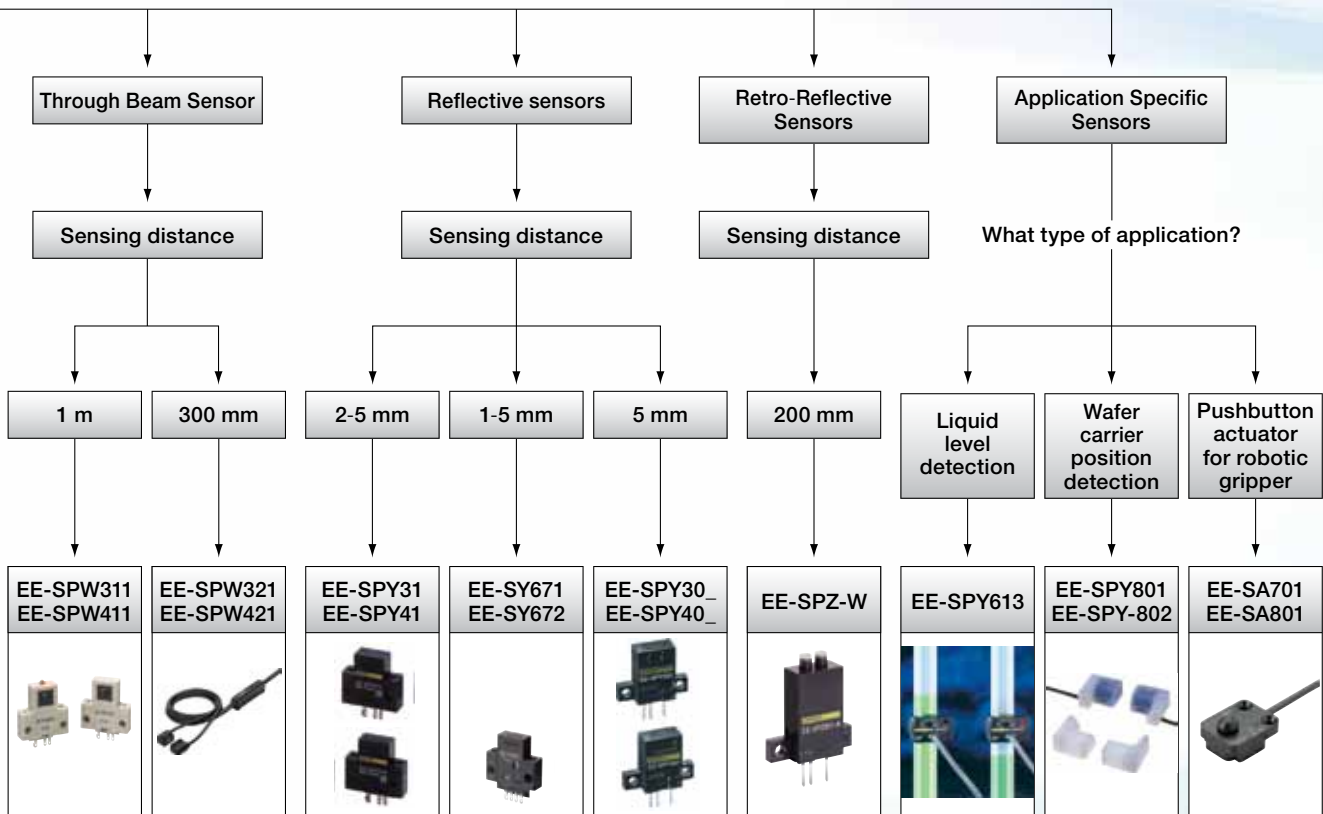
- Wide choice of models: slotted, through-beam, reflective, and retro-reflective
- Special application solutions for liquid level detection, wafer carrier positioning, and object confirmation for robotic grippers











## Selection Table





Type	Slotted Through-Beam			
				
Model	EE-SX91	EE-SX77/87	EE-SX47/67	EE-SPX74/84
Features	<ul style="list-style-type: none"> <li>• 5 models</li> <li>• Indicator visible from many directions</li> <li>• Mount using M2 or M3 Screws</li> <li>• Robot Cable standard</li> </ul>	<ul style="list-style-type: none"> <li>• Compact size</li> <li>• Indicator visible from both sides</li> <li>• M3 mounting holes and slotted mounting holes for easy adjustment</li> </ul>	<ul style="list-style-type: none"> <li>• Visible indicator from many directions</li> <li>• Response frequency as high as 1kHz</li> <li>• Robot Cable standard on pre-wired models</li> </ul>	<ul style="list-style-type: none"> <li>• 4 models</li> <li>• Connectors with locks for vibration applications</li> <li>• Mount with M3 screws</li> </ul>
Housing material	Polybutylene terephthalate (PBT) (Case/Cover) Polycarbonate (PC) (Emitter/receiver)	Polybutylene terephthalate (PBT)	Polybutylene terephthalate (PBT) (Case/Cover) Polycarbonate (PC) (Emitter/receiver)	Polycarbonate (PC)
Sensing distance	5 mm slot width	5 mm slot width	5 mm slot width	3.6 or 5 mm slot width
Output type	NPN, PNP	NPN, PNP	NPN, PNP	NPN
Output configuration	Light-On or Dark-On	Light-On or Dark-On	Light-On/Dark-On (selectable)	Light-On or Dark-On
Supply voltage	5 – 24 VDC	5 – 24 VDC	5 – 24 VDC	5 – 24 VDC
Connection type	<ul style="list-style-type: none"> <li>• Pre-wired (4 wire cable) (1 m std length)</li> </ul>	<ul style="list-style-type: none"> <li>• Pre-wired (3 wire cable) (2 m std length)</li> </ul>	<ul style="list-style-type: none"> <li>• 4 wire cable (1 m std length)</li> <li>• Solder Connector</li> <li>• Connector with 1 m Cable</li> </ul>	<ul style="list-style-type: none"> <li>• Special Connector (EE-1013 with 1 m cable)</li> </ul>

# Amplified Photomicrosensors





Type	Slotted Through-Beam			Diffuse Reflective
				
Model	EE-SX97	EE-SPX-W2A	EE-SPX-303N/403N	EE-SPY31_
Features	<ul style="list-style-type: none"> <li>• Reduced mounting height from deeply embedded socket</li> <li>• 7 mounting shapes</li> <li>• Indicator visible from 4 directions</li> <li>• Locking connectors for secure wiring</li> </ul>	<ul style="list-style-type: none"> <li>• 4 models</li> <li>• Light Modulation to reduce external light interference</li> <li>• Bright Light Indicator</li> </ul>	<ul style="list-style-type: none"> <li>• Widest Slot type</li> <li>• Resistant to common noise</li> </ul>	<ul style="list-style-type: none"> <li>• Can be used in front of shiny background</li> <li>• Small object detection (0.05 mm dia.)</li> <li>• Light modulation reduces external light interference</li> </ul>
Housing material	Polybutylene terephthalate (PBT) (Case/Cover) Polycarbonate (PC) (Emitter/receiver)	Polycarbonate (PC)	Polycarbonate (PC)	Polycarbonate PC (case) Polybutylene terephthalate PBT (holder)
Sensing distance	5 mm slot width	3.6 or 5 mm slot width	13 mm slot width	2 to 5 mm
Output type	NPN, PNP	NPN	NPN	NPN
Output configuration	Light-On and Dark-On	Light-On or Dark-On	Light-On or Dark-On	Light-On or Dark-On
Supply voltage	5 – 24 VDC	5 – 24 VDC	5 – 24 VDC	5 – 24 VDC
Connection type	<ul style="list-style-type: none"> <li>• Commercially available connector: EE-1017 with 1 m or 3m cable; EE-1017-R with 1m or 3m robotic cable</li> </ul>	<ul style="list-style-type: none"> <li>• Pre-wired (3 wire cable) (1 m std length)</li> </ul>	<ul style="list-style-type: none"> <li>• Connector with standard cable</li> <li>• Connector with robot cable</li> <li>• NPN to PNP Conversion connector</li> </ul>	<ul style="list-style-type: none"> <li>• Connector with standard cable</li> <li>• Connector with robot cable</li> <li>• NPN to PNP Conversion connector</li> </ul>

K

# Selection Table

Type	Diffuse Reflective		Through-beam	
				
Model	EE-SY671/672	EE-SPX301/401 EE-SPY301/401	EE-SPW311/411	EE-SPW321/421
Features	<ul style="list-style-type: none"> <li>• Built in sensitivity adjustment</li> <li>• Built-in amplifier with 100 mA capacity</li> <li>• Bright indicator light</li> </ul>	<ul style="list-style-type: none"> <li>• Light Modulation, sensor not affected by external light</li> <li>• Optical Axis mark for easy adjustment</li> </ul>	<ul style="list-style-type: none"> <li>• Through Beam</li> <li>• Easy-to wire connector</li> <li>• Bright indicator light</li> </ul>	<ul style="list-style-type: none"> <li>• Cable mounted amplifier for space savings mounting</li> <li>• Through beam</li> <li>• Both sensor head and amplifier have indicating lights</li> </ul>
Housing material	Polybutylene terephthalate (PBT) (Case/Cover) Polycarbonate (PC) (Emitter/receiver)	Polycarbonate (PC)	Polybutylene terephthalate (PBT) (Case/Cover) Polycarbonate (PC) (Emitter/receiver)	ABS Resin (case) Acrylic Resin (lens)
Sensing distance	1 to 5 mm	3 - 6 mm slot width or 5 mm distance	1 m	300 mm max. distance between sensing heads
Output type	NPN	NPN	NPN	NPN
Output configuration	Light-On/Dark-On (selectable)	Light-On or Dark-On	Light-On or Dark-On	Light-On or Dark-On
Supply voltage	5 – 24 VDC	5 – 24 VDC	5 – 24 VDC	12 – 24 VDC
Connection type	<ul style="list-style-type: none"> <li>• Connector only</li> <li>• Connector with cable</li> <li>• Connector with robot cable</li> </ul>	<ul style="list-style-type: none"> <li>• Connector only</li> <li>• Connector with cable</li> <li>• NPN to PNP Conversion connector</li> </ul>	<ul style="list-style-type: none"> <li>• Connector with 2 m cable</li> </ul>	<ul style="list-style-type: none"> <li>• Pre-wired 2 m cable</li> </ul>

# Amplified Photomicrosensors

Type	Retro-reflective	Liquid level	Pushbutton actuator	Wafer carrier positioning
				
Model	EE-SPZ-A	EE-SPX613	EE-SA701-/801	EE-SPY801/802
Features	<ul style="list-style-type: none"> <li>• Longer sensing distance, simpler to align than diffuse and through-beam sensors</li> <li>• Supports connection with PLCs</li> </ul>	<ul style="list-style-type: none"> <li>• Can mount on 6 mm to 13 mm diameter pipe</li> <li>• Liquid level indicator</li> <li>• Built-in sensitivity selector</li> </ul>	<ul style="list-style-type: none"> <li>• Pushbutton actuator detects FOUP cassettes loading on robotic transfer arms</li> <li>• 5 million operation mechanical life</li> </ul>	<ul style="list-style-type: none"> <li>• Diffuse reflective sensors detect leg section of wafer carriers</li> <li>• Pedestals guide carrier for detection</li> <li>• Left- and right-hand models</li> </ul>
Housing material	Polycarbonate (PC)	Polycarbonate (PC)	Polycarbonate (PC) (Base) Polyacetal (Actuator)	Ethylene tetrafluoro ethylene (ETFE) case Polybutylene terephthalate (PBT) base plate
Sensing distance	200 mm	6-13 mm dia. pipe	3.5-4.5 mm operating position	0-3 mm
Output type	NPN	NPN	NPN or PNP	NPN
Output configuration	Light-On or Dark-On	Light-On/Dark-On (selectable)	—	Dark-On
Supply voltage	5 – 24 VDC	12 – 24 VDC	12 – 24 VDC	12 – 24 VDC
Connection type	<ul style="list-style-type: none"> <li>• Connector only</li> <li>• Connector with cable</li> <li>• NPN to PNP Conversion connector</li> </ul>	<ul style="list-style-type: none"> <li>• Pre-wired 1 m cable</li> </ul>	<ul style="list-style-type: none"> <li>• Pre-wired 1 m cable</li> <li>• Pre-wired 1 m robot cable</li> </ul>	<ul style="list-style-type: none"> <li>• Pre-wired with 2 m, talc-free cable</li> </ul>

K

# Amplified Photomicrosensors







## Ultra-Small Size Offers Sensing Solution for Space Constrained Locations

- 5 body shapes enable easier fit and alignment
- Indicator light can be viewed from 4 directions for easy installation and operation
- Easy to mount with either M3 or M2 screws
- Separate pre-wired junction connector or pre-wired 2 m cable models
- Flexible robot cable is standard on all models, ideal for moving part applications
- Wire selectable Dark-ON or Light-ON output



## Pre-Wired Slotted Photomicrosensors

Appearance	Sensor type	Slot width/depth	Dimensions H x W x D mm	Output form	Connection method (cable length)	Model	
						NPN Output	PNP Output
	Through-beam	5 mm W x 6.5 mm H	12 x 24 x 6	Light-ON Dark-ON (2 outputs)	Pre-wired models (1 m)	EE-SX910-R	EE-SX910P-R
					Models with junction connectors (0.3 m)	EE-SX910-C1J-R	-
			12 x 13.4 x 12		Pre-wired models (1 m)	EE-SX911-R	EE-SX911P-R
					Models with junction connectors (0.3 m)	EE-SX911-C1J-R	-
			12 x 13.4 x 11.7		Pre-wired models (1 m)	EE-SX912-R	EE-SX912P-R
					Models with junction connectors (0.3 m)	EE-SX912-C1J-R	EE-SX912P-C1J-R
			12 x 13.4 x 11.7		Pre-wired models (1 m)	EE-SX913-R	EE-SX913P-R
					Models with junction connectors (0.3 m)	EE-SX913-C1J-R	-
			16 x 13.4 x 6		Pre-wired models (1 m)	EE-SX914-R	EE-SX914P-R
					Models with junction connectors (0.3 m)	EE-SX914-C1J-R	-

## Connector

Appearance	Item	Description	Dimensions H x W x D mm	Model
	Connector with cable	2 m cable	8 x 10 x 5.8	EE-1016-R

K

# EE-SX77□/EE-SX87□ Slotted Photomicrosensors





## Pre-Wired Photomicrosensors with Open Collector Output

- Standard, L-shaped, and T-shaped models available
- Pre-wired with 2 m flexible cable that conforms to machine contours
- Models available with Light-ON or Dark-ON output configurations
- Response frequency as high as 1 kHz
- Easy to monitor, indicators are visible from both sides
- Indicator turns OFF when light is interrupted; opposite operation models available
- Readily-visible, molded workpiece insertion mark allows fine-tuning of sensing position
- Allows standard M3-screw mounting
- Wide operating voltage range simplifies sensor connection to TTLs, relays, and programmable controllers (PLC)
- Ideal for use in end-of-travel, home position and operation trigger applications



## Pre-Wired Slotted Photomicrosensors









Appearance	Sensor type	Slot width/depth	Dimensions H x W x D mm	Output form	Output Type	Model
	Through-beam (slot)	5 mm W x 9 mm D	31.1 x 18 x 4.6	Light-ON	NPN	EE-SX870
					PNP	EE-SX870P
				Dark-ON	NPN	EE-SX770
					PNP	EE-SX770P
			21 x 18 x 13	Light-ON	NPN	EE-SX871
					PNP	EE-SX871P
				Dark-ON	NPN	EE-SX771
					PNP	EE-SX771P
			31.1 x 12.3 x 19.1	Light-ON	NPN	EE-SX872
					PNP	EE-SX872P
				Dark-ON	NPN	EE-SX772
					PNP	EE-SX772P

### Widest Variety of Body Shapes of Connector-Ready Slotted Sensors

- 8 body configurations available with connector, pre-wired cable or pre-wired connector
- Easy operation monitoring with bright LED indicator
- Choose Light-ON or Light-ON/Dark-ON output models
- Light modulation reduces external light interference
- Flexible robot cable is standard on all pre-wired models
- Wide operating voltage range simplifies sensor connection to TTLs, relays and programmable controllers (PLC)



### Connector-Ready Slotted Photomicrosensors

Shape	Sensor type	Slot width/depth	Dimensions H x W x D mm	Output form	Indicator operation	Output Type	Model
	Through-beam	5 mm W x 9 mm H	28.4 x 25.4 x 6.95	Light-ON	Light-ON	NPN	EE-SX470
				Light-ON/Dark-ON selectable	Dark-ON		EE-SX670
					Light-ON		EE-SX670A
				Dark-ON	PNP	EE-SX670P	
			15.5 x 26.2 x 20.7	Light-ON	Light-ON	NPN	EE-SX471
				Light-ON/Dark-ON selectable	Dark-ON		EE-SX671
					Light-ON	EE-SX671A	
				Dark-ON	PNP	EE-SX671P	
		7 mm W x 9 mm H	28.4 x 29 x 13.7	Light-ON	Light-ON	NPN	EE-SX472
				Light-ON/Dark-ON selectable	Dark-ON		EE-SX672
					Light-ON		EE-SX672A
				Dark-ON	PNP	EE-SX672P	
		5 mm W x 9 mm H	28.4 x 13.4 x 12.8	Light-ON	Light-ON	NPN	EE-SX473
				Light-ON/Dark-ON selectable	Dark-ON		EE-SX673
					Light-ON		EE-SX673A
				Dark-ON	PNP	EE-SX673P	
			15.5 x 13.6 x 27.7	Light-ON	Light-ON	NPN	EE-SX474
				Light-ON/Dark-ON selectable	Dark-ON		EE-SX674
					Light-ON	EE-SX674A	
				Dark-ON	PNP	EE-SX674P	
		10 mm W x 9 mm H	28.4 x 31 x 16.7		Light-ON	NPN	EE-SX675
						PNP	EE-SX675P
		5 mm W x 9 mm H	28.4 x 13.2 x 13.7			NPN	EE-SX676
						PNP	EE-SX676P
						NPN	EE-SX677
						PNP	EE-SX677P



K











# EE-SX47□/EE-SX67□ Slotted Photomicrosensors (continued)



## Connectors and Accessories (continued)

Appearance	Item	Description	Dimensions H x W x D mm	Model
	Solder connector	—	16.8 x 13.0 x 4.0	EE-1001
		Makes selectable operation models into Light-ON operation sensors. The L and positive (+) terminals are already short-circuited.		EE-1001-1
		Connector has locking mechanism	13.5 x 13 x 4	EE-1009
	Connector with cable	2 m cable	11.8 x 16.2 x 5.3	EE-1006

## Pre-Wired Slotted Photomicrosensors

Shape	Sensor type	Slot width/ depth	Dimensions H x W x D mm	Output form	Connection Method (cable length)	Model	
						NPN Output	PNP Output
	Through-beam	5 mm W x 9 mm H	28.4 x 25.4 x 6.95	Light-ON Dark-ON (select- able)	Pre-wired models (1 m)	EE-SX670-WR	EE-SX670P-WR
					Models with junction connectors (0.3 m)	EE-SX670-C1J-R	EE-SX670P-C1J-R
		15.5 x 26.2 x 20.7	Pre-wired models (1 m)		EE-SX671-WR	EE-SX671P-WR	
			Models with junction connectors (0.3 m)		EE-SX671-C1J-R	EE-SX671P-C1J-R	
		7 mm W x 9 mm H	28.4 x 29 x 13.7		Pre-wired models (1 m)	EE-SX672-WR	EE-SX672P-WR
					Models with junction connectors (0.3 m)	EE-SX672-C1J-R	EE-SX672P-C1J-R
		5 mm W x 9 mm H	28.4 x 13.4 x 12.8		Pre-wired models (1 m)	EE-SX673-WR	EE-SX673P-WR
					Models with junction connectors (0.3 m)	EE-SX673-C1J-R	EE-SX673P-C1J-R
		15.5 x 13.6 x 27.7	Pre-wired models (1 m)		EE-SX674-WR	EE-SX674P-WR	
			Models with junction connectors (0.3 m)		EE-SX674-C1J-R	EE-SX674P-C1J-R	
	10 mm W x 9 mm H	28.4 x 31 x 16.7	Pre-wired models (1 m)	EE-SX675-WR	EE-SX675P-WR		
			Models with junction connectors (0.3 m)	EE-SX675-C1J-R	EE-SX675P-C1J-R		
	5 mm W x 9 mm H	28.4 x 13.2 x 13.7	Pre-wired models (1 m)	EE-SX676-WR	EE-SX676P-WR		
			Models with junction connectors (0.3 m)	EE-SX676-C1J-R	EE-SX676P-C1J-R		
	28.4 x 13.2 x 13.7	Pre-wired models (1 m)	EE-SX677-WR	EE-SX677P-WR			
		Models with junction connectors (0.3 m)	EE-SX677-C1J-R	EE-SX677P-C1J-R			

### Space Saving Sensor with Secure Connector

- Deeply embedded socket reduces overall mounting height
- 7 shapes to match most applications
- Light-ON and Dark-ON outputs wire selectable
- PNP and NPN output models
- Locking connector for secure wiring
- Indicator visible from 4 directions
- Power reverse polarity protection and output overcurrent with thermal
- Shutdown circuit built into NPN output models

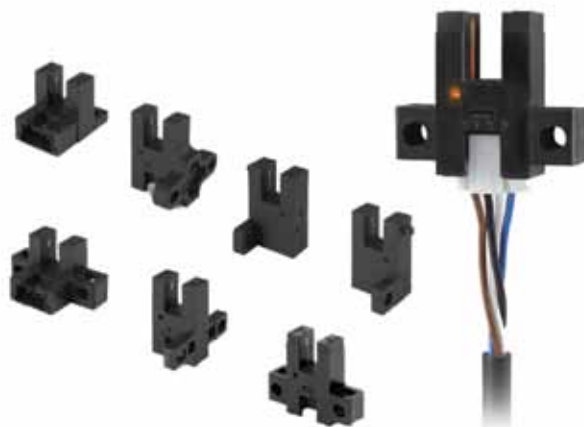

### Connector-Ready Slotted Photomicrosensors

Shape	Sensor type	Slot width/depth	Dimensions H x W x D mm	Output form	NPN output Model	PNP output model
Standard	Through beam with slot	5 W x 9 D mm	22 x 26 x 6.8	Dark-ON/ Light-ON/ (selectable)	EE-SX970-C1	EE-SX970PC1
L-shaped		5 W x 9 D mm	15.5 x 26.2 x 14.7		EE-SX971-C1	EE-SX971PC1
T-shaped		5 W x 9 D mm slot center 7 mm	22 x 13.7 x 26		EE-SX972-C1	EE-SX972PC1
Close-mounting		5 W x 9 D mm	15.5 x 13.4 x 21.7		EE-SX974-C1	EE-SX974PC1
T-shaped slot center 10 mm		5 W x 9 D mm slot center 10 mm	22 x 16.7 x 26		EE-SX975-C1	EE-SX975PC1
T-shaped		5 W x 9 D mm	22 x 15.9 x 13.2		EE-SX976-C1	EE-SX976PC1
F-shaped		5 W x 9 D mm	22 x 15.9 x 13.2		EE-SX977-C1	EE-SX977PC

### Connector

Description	Cable length	Model
Connector with standard cable	1 m	EE-1017 1M
	3 m	EE-1017 3M
Connector with robotic cable	1 m	EE-1017-R 1M
	3 m	EE-1017-R 3M

# EE-SPX74□/EE-SPX84□

## Slotted Photomicrosensors







### Connector-Ready Photomicrosensors with Open Collector Output

- Compact sensor for high-density mounting
- Standard, L-shaped, and T-shaped models available
- Easy to maintain, plugs into Connector cordset EE-1013
- Connector features built-in safety lock vibration and shock resistance
- Models available with Light-ON or Light-ON/Dark-ON output configurations
- Powerful light modulation against external light interference
- Easy operation monitoring with bright LED indicator
- Wide operating voltage range simplifies sensor connection to TTLs, relays, and programmable controllers (PLC)
- Ideal for use in end-of-travel, home position and operation trigger applications



### Plug-In Slotted Photomicrosensors

Shape	Sensor type	Slot width/depth	Dimensions H x W x D mm	Output form	Model
	Through beam (slot)	3.6 mm W x 6.6 mm D	21.2 x 25 x 7.4	Light-ON	EE-SPX840
				Dark-ON	EE-SPX740
			21.2 x 15.5 x 13	Light-ON	EE-SPX842
				Dark-ON	EE-SPX742
				Light-ON	EE-SPX843
				Dark-ON	EE-SPX743
		5 mm W x 9 mm H	15.4 x 27.2 x 15.5	Light-ON	EE-SPX841
				Dark-ON	EE-SPX741

### Connector

Appearance	Item	Description	Dimensions H x W x D mm	Model
	Connector with cable	1 m cable	11.8 x 16.2 x 5.3	EE-1013

# EE-SPX301/401

## Slotted/Reflective Photomicrosensors





### Narrow Slot Sensors and Reflective Sensors with Plug in Connection

- Slotted DC sensor with plug-in connection for counting and presence/absence detection applications
- Light modulation reduces external light interference
- Light-ON and Dark-ON operation models
- Built-in Light-ON indicator
- Connector simplifies installation and maintenance: choose connector with 1 m cable (EE-1003) or solder terminals (EE-1002)
- Convert EE-SPX301/401 NPN output to PNP with EE-2001 output converter



### Photomicrosensors

Appearance	Sensor type	Sensing distance	Dimensions H x W x D mm	Output form	Output Type	Model
	Through beam with slot	3.6 W x 9 L mm slot	31.5 H x 26 W x 7 D mm	NPN	Dark-ON	EE-SPX301
					Light-ON	EE-SPX401
	Diffuse reflective	5 mm	27.5 H x 26 W x 7 D mm		Dark-ON	EE-SPY301
					Light-ON	EE-SPY401
	Diffuse reflective	5 mm	27.5 H x 26 W x 7 D mm		Dark-ON	EE-SPY302
					Light-ON	EE-SPY402

### Connectors and Accessories

Description	Model
Solder connector	EE-1002
Connector with cable 1 m length	EE-1003
Connector hold-down clip for EE-1003	EE-1003A
NPN/PNP conversion connector, 0.46 length	EE-2001

# EE-SPX-W2A

## Slotted Photomicrosensors





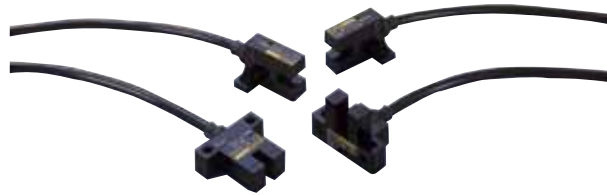

### Pre-Wired Photomicrosensors with Open Collector Output

- Compact sensor for high-density mounting
- Standard, L-shaped, and T-shaped models available
- Incorporating dust-proof slit
- Detects objects as small as 0.5 mm diameter
- Light-ON or Dark-ON output configurations models available
- Optical axis monitoring with a Light-ON indicator
- Light modulation effectively reduces external light interference
- Pre-wired with 2 m cable



### Pre-Wired Photomicrosensors

Appearance	Sensor type	Slot width/depth	Dimensions H x W x D mm	Output form	Output Type	Model
 Standard	Through beam (slot)	3.6 mm W x 6.6 mm D	29.2 x 25 x 7.4	Light-ON	NPN	EE-SPX306-W2A
				Dark-ON		EE-SPX406-W2A
 L-shaped, left tab			29.2 x 15.5 x 13	Light-ON		EE-SPX302-W2A
				Dark-ON		EE-SPX402-W2A
 L-shaped, right tab			21.2 x 15.5 x 13	Light-ON		EE-SPX304-W2A
				Dark-ON		EE-SPX404-W2A
 T-shaped		5 mm W x 9 mm H	15.5 x 27.2 x 22.5	Light-ON	EE-SPX305-W2A	
				Dark-ON	EE-SPX405-W2A	

# EE-SPX303N/EE-SPX403N

## Slotted Photomicrosensors

Quick Link

B428

### Connector-Ready Wide Slot Sensors





- Large slot width (13 mm W x 10 mm D)
- Models available with Light-ON or Dark-ON output configurations
- Powerful light modulation against external light interference
- Easy adjustment and optical axis monitoring with a Light-ON indicator
- Convert to PNP output with EE-2002 conversion connector

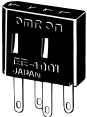

### Wide Slot Photomicrosensors

Appearance	Sensor type	Slot width/depth	Dimensions H x W x D mm	Output form	Output Type	Model
	Through beam with slot	13 mm W x 10 mm D	26 x 26 x 7.4	Light-ON	NPN	EE-SPX303N
				Dark-ON		EE-SPX403N

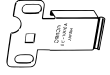
### Connectors and Accessories

Appearance	Item	Description	Dimensions H x W x D mm	Model
	Solder connector	Connector makes selectable operation sensors into Light-ON operation sensors. Short-circuits L and positive (+) terminals.	16.8 x 13.0 x 4.0	EE-1001
	Connector with cable	2 m cable	11.8 x 16.2 x 5.3	EE-1006
	Connector holder	For EE-1006	25.2 x 29.2 x 5.5	EE-1006A
	Connector with cable	2 m cable	13.5 x 13.0 x 4.0	EE-1010
	Connector with robotic cable			EE-1010R
	NPN/PNP conversion connector		16.2 x 11.8 x 5.3	EE-2002

K

# EE-SPY31□/EE-SPY41□

## Reflective Photomicrosensors

Quick Link



B429

### Connector-Ready Reflective Sensors

- Detect dark colored objects and targets in front of mirror-like backgrounds
- Detect objects as small as 0.05 mm diameter copper wire
- 2 to 5 mm sensing distance
- Vertical and horizontal mounting models available
- Easy to maintain, plugs into Connector cordset EE-1006
- Light modulation effectively reduces external light interference
- Easy operation monitoring with bright LED indicator



### Plug-in Reflective

Appearance	Sensor type	Slot width/depth	Dimensions H x W x D mm	Output form	Output type	Model
Horizontal 	Convergent reflective	2-5mm	29 x 26 x 8	Dark-ON	NPN	EE-SPY311
				Light-ON		EE-SPY411
Vertical 				Dark-ON		EE-SPY312
				Light-ON		EE-SPY412

# EE-SY671/EE-SY672

## Reflective Photomicrosensors

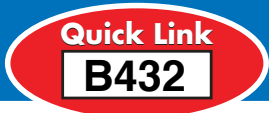



### Reflective Sensors with Sensitivity Adjuster

- 1 to 5 mm sensing distance
- Vertical and horizontal mounting models available
- Light-ON/Dark-ON output wire selectable
- Light modulation effectively reduces external light interference
- Easy operation monitoring with bright LED indicator



### Pre-Wired Photomicrosensors

Appearance	Sensor type	Sensing distance	Dimensions H x W x D mm	Output form	Output type	Model
 Horizontal	Convergent reflective	1 to 5mm	31.4 x 25.4 x 6.95	Light-ON/Dark-ON selectable	NPN	EE-SY671
 Vertical			31.2 x 25.4 x 6.95			EE-SY672





# EE-SPW311/411

## Through-Beam Photomicrosensors



### Long Distance Miniature Sensors with Built-In Amplifier



- 1 meter sensing distance with 5 mm diameter minimum object size
- Models available with Light-ON or Dark-ON output configurations
- Light modulation effectively reduces external light interference
- Easy operation monitoring with bright LED indicator
- Cordsets with 2 m cable supplied for emitter and receiver
- Convert to PNP output with EE-2002 conversion connector
- Extend cabling up to 10 m

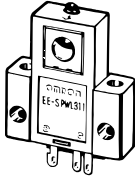

### Pre-Wired Photomicrosensors

Appearance	Sensor type	Sensing Distance	Dimensions H x W x D mm	Output form	Output type	Model
 (Receiver shown)	Through-beam	1 m	33.2 x 25.4 x 8.6	Light-ON	NPN	EE-SPW411
				Dark-ON		EE-SPW311

### Connector Cordsets (Cordsets Included with Sensor)

Appearance	Sensor type	Description	Dimensions H x W x D mm	Model
	Emitter cordset	2 m cable, 2 conductors	29 x 26 x 8	EE-1006L
	Receiver cordset	2 m cable, 3 conductors	16.2 x 11.8 x 5.3	EE-1006D

# EE-SPW321/421

## Through-Beam Photomicrosensors



### Miniature Sensing Heads with In-Line Cable Amplifier

- 30 cm sensing distance with 2 mm diameter minimum object size
- Detect objects as small as 0.5 mm using slit pairs supplied
- Operation indicators allow monitoring from the amplifier housing or sensor head
- Models available with Light-ON or Dark-ON output configurations
- Light modulation effectively reduces external light interference
- Slim amplifier (12 H x 7.5 W x 50 D mm) with NPN output for easy handling and mounting
- Pre-wired with 2 m, 3-conductor cable for simple wiring
- 0.5 or 1 m sensing head-to-amplifier cable lengths available



### Pre-Wired Photomicrosensors

Appearance	Sensor type	Sensing distance	Dimensions H x W x D mm	Output form	Output type	Model
	Through-beam	30 cm	14 x 5.8 x 14, 0.5 m cable	Light-ON	NPN	EE-SPW421
			14 x 5.8 x 14, 1 m cable			EE-SPW421A
			14 x 5.8 x 14, 0.5 m cable	Dark-ON		EE-SPW321
			14 x 5.8 x 14, 0.5 m cable			EE-SPW321A

### Slit Sets

Reduce beam size to detect smaller objects more accurately by applying slits to the emitter and receiver. Two sizes included with the sensor.

Size of aperture	Sensing distance	Minimum object size
0.5 x 3 mm	10 cm	Opaque: 0.5 mm dia.
1 x 3 mm	20 cm	Opaque: 1 mm dia.



### Liquid Level Sensor with Built-In Amplifier

- Detect liquid level in manufacturing processes used in food & beverage and semiconductor industries
- Fits 6-13 mm diameter transparent or semi-transparent pipe with a wall thickness of 1 mm
- Easy to install tie-wrap and rubber tube provided to prevent slippage
- Incorporates a sensitivity selector, built-in amplifier, and operation mode selector
- Built-in amplifier with NPN output saves space and wiring effort
- Pre-wired with 1 m, talc-free cable, safe for use in clean room equipment

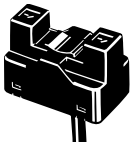

### Liquid Level Photomicrosensor

Appearance	Sensor type	Sensing Distance	Dimensions H x W x D mm	Output form	Output type	Model
	Through-beam (slot)	6-13 mm diameter pipes, as transparent as FEP	16 x 26 x 19	Light-ON/ Dark-ON selectable	NPN	EE-SPX613

# EE-SPZ-A

## Retro-reflective Photomicrosensors with Lens

Quick Link

B438

### Longer Sensing Distance, Simpler to Align Than Diffuse and Through-Beam Sensors

- Photomicrosensor with light modulation for reduced external light interference
- Easy adjustment and optical axis monitoring with a light indicator
- Wide operating voltage range: 5 to 24 VDC
- Supports connection with Programmable Controllers (PLCs)
- Easy-to-wire connectors assure easy maintenance

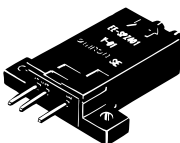

### Photomicrosensors

Appearance	Sensor type	Sensing distance	Output type	Output configuration	Model
	Retro-reflective type	200 mm	NPN output	Dark-ON	EE-SPZ301-A
				Light-ON	EE-SPZ401-A

### Accessories (Order Separately)

Type	Cable length	Model	Remarks
Connector	–	EE-1002	–
Connector with cable	1 m	EE-1003	–
NPN/PNP Conversion Connector	0.46 m (total length)	EE-2001	–
Connector Hold-Down Clip	–	EE-1003A	For EE-1003 only.
Reflector	–	E39-R1	–

# EE-SA701/801

## Pushbutton-type Photomicrosensors

Quick Link

B439

### Pushbutton Actuator Accurately Detects Presence of Difficult-to-Detect Objects

- Conforms to semiconductor standards to enable accurate detection of FOUNDED cassettes without being affected by the material, color, or reflectance of the cassette bottoms. Thin design enables mounting in a wider range of applications, e.g., on transfer arms
- Increased visibility with 4-direction indicator
- Optical detection of actuator operation provides a long life (mechanical life: 5 million operations min.)
- Models with PNP or NPN output
- Models are available with very flexible robot cable



### Pushbutton Type Photomicrosensor

Appearance	Sensor distance	Sensing method	Operation mode	Cable length	Model	
					NPN output	PNP output
	0 to 3.5 mm (pressed position) (see note. 1)	Pushbutton	ON with no load	1 m	EE-SA801A 1M	EE-SA801R 1M
				1 m (robot cable)	EE-SA801A-R 1M	EE-SA801R-R 1M
			OFF with no load		EE-SA701-R- 1M	EE-SA701P-R 1M

Note: 1. Distance from the top surface of the housing to the top of the actuator.

# EE-SPY801/802

## Special Application Photomicrosensors





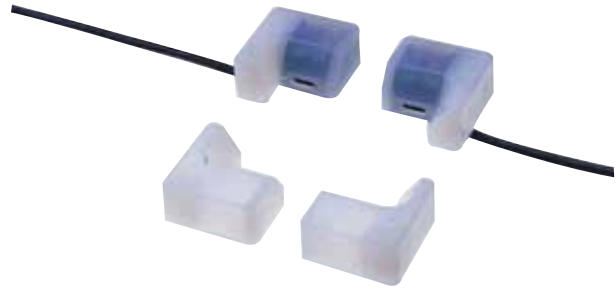

### Wafer Carrier Position Sensor

- Unique optical system enables stable detection of almost all wafer-carriers
- Contact surfaces with the wafer carrier use a special chemical-resistant fluororesin
- Set the mounting position using optional pedestals
- Light modulation effectively reduces external light interference
- Pre-wired with 2 m, talc-free cable, safe for use in clean room equipment



### Pre-Wired Photomicrosensors

Appearance	Sensor type	Sensing distance	Dimensions H x W x D mm	Output form	Output Type	Model
	Diffuse reflective	0-3 mm	15 x 32 x 30	Turns on when a wafer carrier is present	NPN	EE-SPY801
						EE-SPY802
	Pedestal (no sensor function)	—	15 x 32 x 30	Guides carrier for detection	—	EE9-C01
						EE9-C02

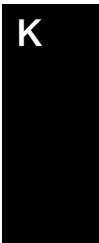

### Application

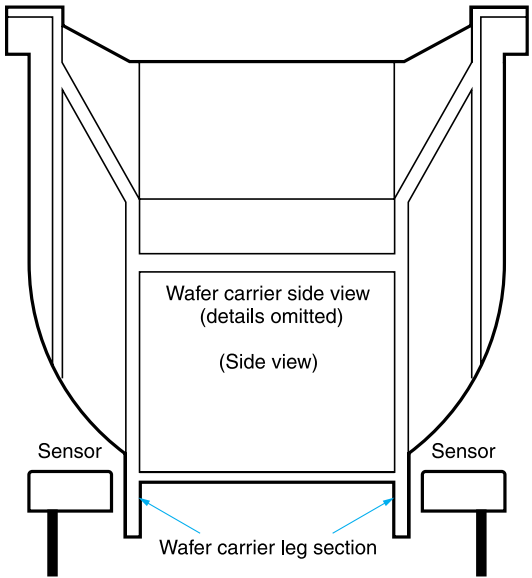
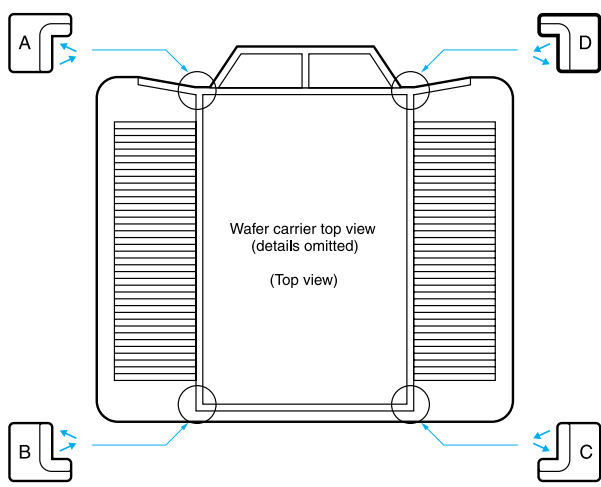
<p>Mount sensors to detect the support rails along the bottom of the wafer carrier.</p>  <p>Wafer carrier side view (details omitted) (Side view)</p> <p>Sensor</p> <p>Wafer carrier leg section</p> <p>Sensor</p>	<p>Install a Sensor or Pedestal at each of the four corners indicated by a circle in the following diagram.</p>  <p>Wafer carrier top view (details omitted) (Top view)</p> <p>Points A and C Points B and D</p>	
<table border="1" style="width: 100%;"> <tr> <td style="width: 50%; padding: 5px;">                 EE-SPY801 or EE9-C01                  EE-SPY802 or EE9-C02             </td> </tr> </table>		EE-SPY801 or EE9-C01 EE-SPY802 or EE9-C02
EE-SPY801 or EE9-C01 EE-SPY802 or EE9-C02		

# Amplified Photomicrosensors



<b>Contents</b>		
<b>Selection Guide</b>		L-ii
<b>Profiling</b>		
<b>ZG2</b>	2D measurement sensor	L-1
<b>Displacement</b>		
<b>Smart Amplifier Models</b>		
<b>ZS-L</b>	Scalable precision laser measurement sensor	L-2
<b>ZS-HL</b>	Scalable high-precision and long distance measurement sensor	L-3
<b>ZX-L-N</b>	Laser measurement sensors, smart amplifier	L-4
<b>ZX1</b>	CMOS laser displacement sensors with built-in amplifier, long distance models	L-5
<b>ZX2</b>	CMOS laser displacement sensors for stable measurement	L-6
<b>ZX-GT</b>	Wide laser measurement sensors, smart amplifier	L-7
<b>ZX-E</b>	Inductive displacement sensors, smart amplifier	L-8
<b>ZX-T</b>	Contact displacement sensors, smart amplifier	L-9
<b>Special Application Models</b>		
<b>E2C-EDA</b>	High-resolution digital proximity sensor with separate amplifier	L-10
<b>E3C-LDA</b>	Variable laser beam sensors with separate digital amplifier	L-11





## HIGH-PRECISION QUALITY INSPECTION

### Zero defect becomes reality—scalable accuracy in inspection

The Smart displacement sensor family offers a modular and scalable approach to solve the most challenging measurement tasks. This powerful portfolio enables you to measure profiles, thickness, distance, evenness/warpage, as well as width, edge, and more. Several measurement profiles can be performed simultaneously, using a single- or multi-controller unit. Aided by Omron's advanced technologies, the highest accuracy over long distances, speed and reliability will be achieved.

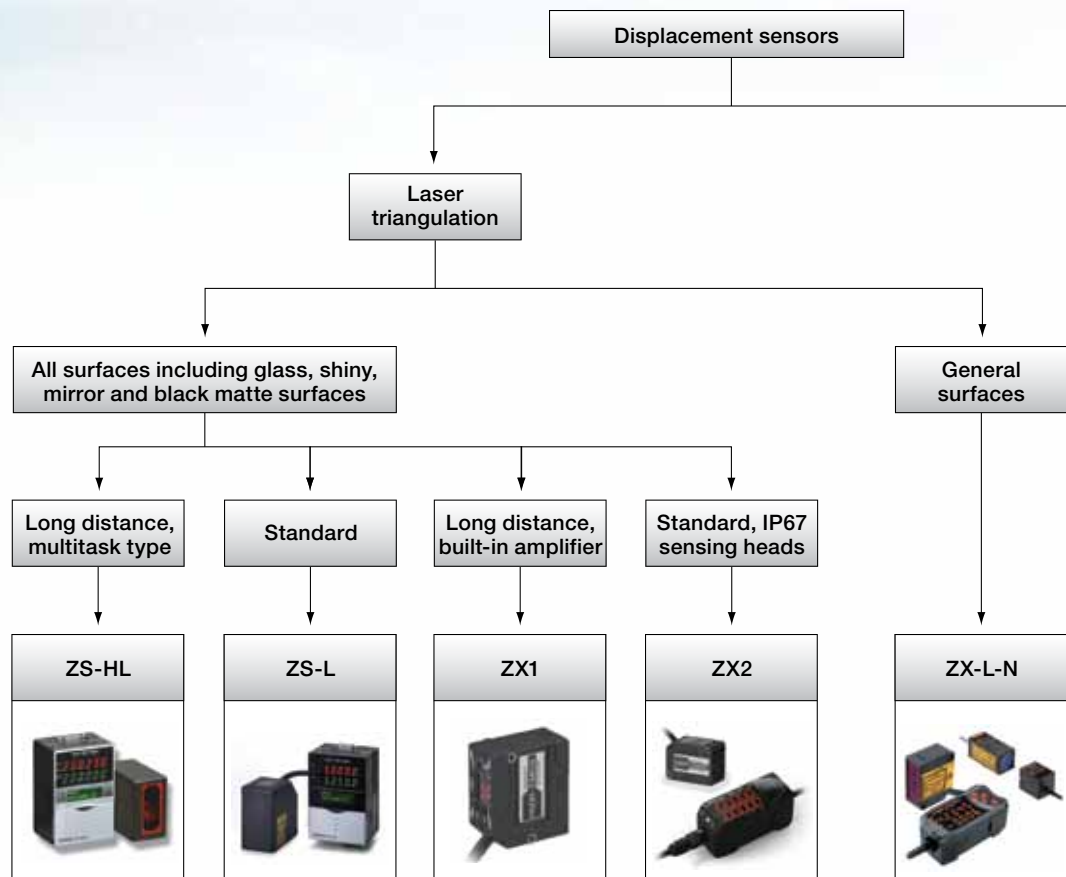

- Accurate and fast – models available with 0.25  $\mu\text{m}$  at less than 110  $\mu\text{s}$  sampling time
- Scalable – multi-controller connectivity allows coordinate measurement with multiple points
- Smart – data storage and remote control via networking capabilities

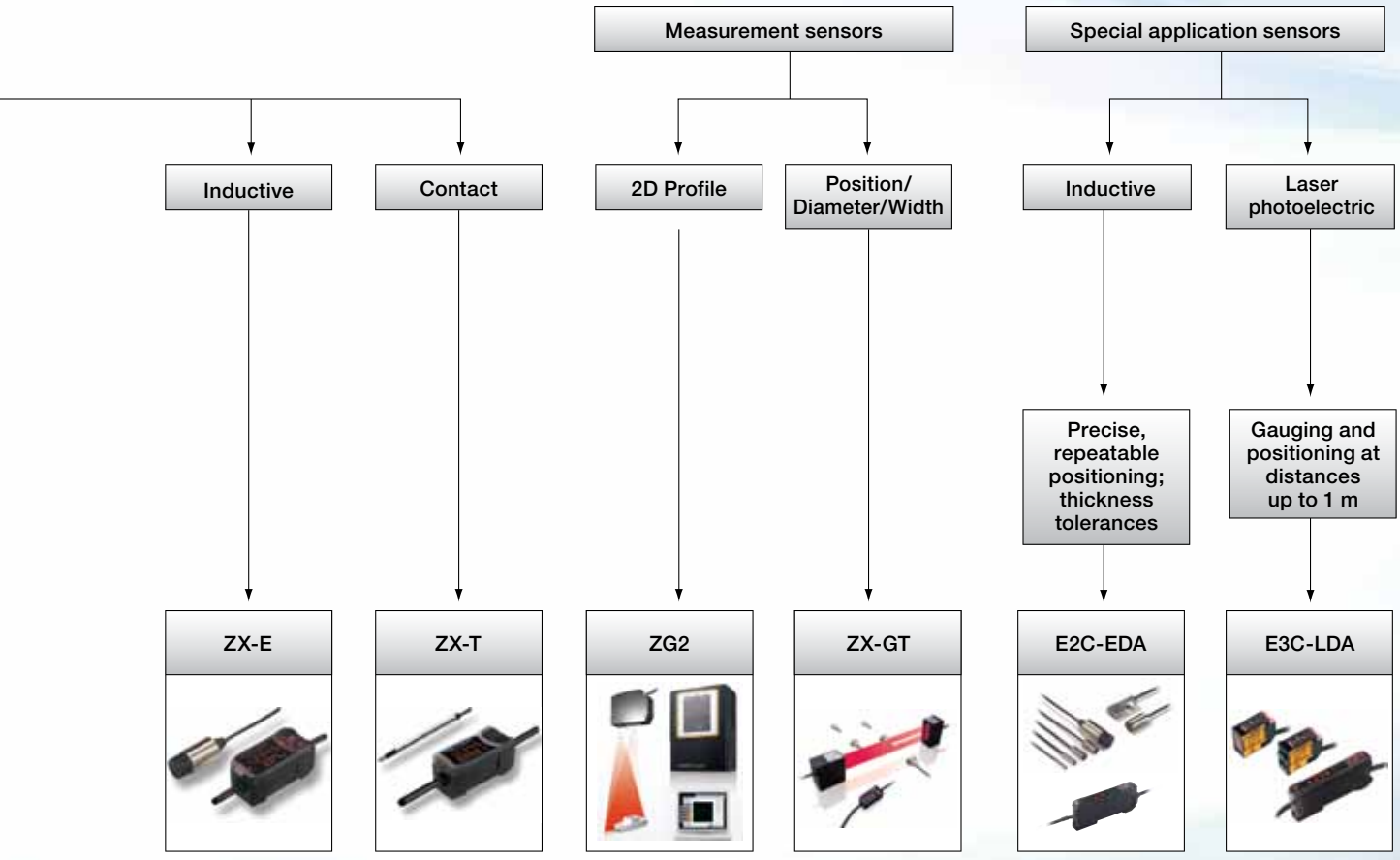







L

# Selection Table

		1D Smart laser measuring sensors		
				
		ZS-HL	ZS-L	ZX-L-N
Selection criteria	Model			
	Measurement range Z Min.	10 ±0.5 mm	20±1 mm	30 ±2 mm
	Max.	1500 ±500 mm	350±135 mm	300 ±200 mm
	Spot diameter Min.	–	–	–
	Max	–	–	–
	Resolution	0.25 µm	0.25 µm	0.25 µm
	Resolution X	–	–	–
	Linearity (±% of full scale)	0.05%	±0.1%	0.2%
	Response time	110 µs	110 µs	150 µs
	Spot beam	■	■	■
	Line beam	■	■	■
	IP-rating head	IP64/IP67	IP66 (0.5m); IP67 (2m)	IP50
	IP-rating controller	IP40	IP40	IP40
	Ambient oper. temperature	0 to 50°C	0 - 50 C°	0 to 50°C
Number of connectable sensors	9	9	5	
Features	Thickness measurement	■	■	■
	Eccentricity	■	■	■
	Height	■	■	■
	Step	■	■	■
	Profile	–	–	–
	Distance	–	■	–
	Evenness	–	–	–
	Warpage	–	–	–
	Edge	–	–	–
	Width	–	–	–
	Peak	■	■	■
	Peak to peak	■	■	■
	Bottom	■	■	■
	Self-trigger	■	■	■
	Calibration	■	–	■
	Signal scaling	–	–	■
	PC-software	■	■	■
Application	Mirror	■	■	–
	Glass	■	■	–
	Metal	■	■	□
	Plastic	■	■	■
	Black rubber	■	■	–
	Paper	■	■	□
Supply voltage	VDC	21.6 to 26.4 VDC	21.6 to 26.4 VDC	12 to 24 VDC
Control I/O	4 to 20 mA	■	■	■
	1 to 5 VDC	–	■	■
	Judgement output High/Pass/Low	■	■	■
	Trigger	■	■	■
Communication	RS-232C	■	■	■
	USB 2.0	■	■	–

■ Standard    □ Available    – No/not available

# Measurement Sensors

		1D Smart laser measuring sensors	1D Smart laser measuring sensors	Inductive measuring sensors	Contact measuring sensors	
						
Selection criteria	Model	ZX1	ZX2	ZX-E	ZX-T	
	Measurement range Z	Min.	50+/-10mm	48±5 mm	0.5 mm	1 mm
		Max.	600+/-400mm	100±35mm	7 mm	10 mm
	Spot diameter	Min.	0.17mm	60 µm	–	–
		Max	0.56mm	110 µm	–	–
	Resolution	2 to 80 µm	1.5 µm - 5 µm	1 µm	0.1 µm	
	Resolution X	–	–	–	–	
	Linearity (±% of full scale)	0.15 to 0.5% F.S	±0.05 to 0.1% F.S	0.5%	0.3%	
	Response time	1 ms	30 µs	150 µs	1 ms	
	Spot beam	■	■	–	–	
	Line beam	■	■	–	–	
	IP-rating head	IP67	IP67	IP67	IP67	
	IP-rating controller	–	IP40	IP40	IP40	
	Ambient oper. temperature	-10 to +55C	0 to +50°C	0 to 50°C	0 to 50°C	
	Number of connectable sensors	1	5	5	7	
Features	Thickness measurement	–	■	■	■	
	Eccentricity	–	■	■	■	
	Height	■	■	■	■	
	Step	–	■	■	■	
	Profile	–	–	–	–	
	Distance	■	■	■	■	
	Evenness	–	■	■	■	
	Warpage	–	■	■	■	
	Edge	–	–	–	–	
	Width	–	■	–	–	
	Peak	■	■	■	■	
	Peak to peak	■	■	■	■	
	Bottom	■	■	■	■	
	Self-trigger	–	■	■	■	
	Calibration	■	■	■	–	
	Signal scaling	–	■	■	■	
	PC-software	–	–	■	■	
	Application	Mirror	■	■	–	■
		Glass	■	■	–	■
		Metal	■	■	■	■
Plastic		■	■	–	■	
Black rubber		■	■	–	■	
Paper		■	■	–	–	
Supply voltage	VDC	10 to 30 VDC	10 to 30 VDC	12 to 24 VDC	12 to 24 VDC	
	4 to 20 mA	■	■	■	■	
Control I/O	1 to 5 VDC	–	■ and ±5 V	■	■	
	Judgement output High/Pass/Low	■	■	■	■	
	Trigger	■	■	■	■	
Communication	RS-232C	–	–	■	■	
	USB 2.0	–	–	–	–	



\* For unit specifics see data sheets.

■ Standard

□ Available

– No/not available

# Selection Table

		Profile measuring sensor	Smart laser micrometer
			
		ZG2	ZX-GT
Selection criteria	Model	ZG2	ZX-GT
	Measurement range Z Min.	22.3 ±0.5 mm	–
	Max.	210 ±48 mm	28 mm
	Spot diameter Min.	3 mm	–
	Max	70 mm	–
	Resolution	0.25 µm	10 µm
	Resolution X	* 631 pixels	–
	Linearity (±% of full scale)	0.5%	0.1%
	Response time	5 ms	0.5 ms
	Spot beam	–	–
	Line beam	■	■
	IP-rating head	IP66/67	IP40
	IP-rating controller	IP20	IP40
	Ambient oper. temperature	0 to 50°C	0 to 50°C
	Number of connectable sensors	1	5
Features	Thickness measurement	■	■
	Eccentricity	■	■
	Height	■	■
	Step	■	–
	Profile	□	–
	Distance	■	–
	Evenness	–	–
	Warpage	–	–
	Edge	–	■
	Width	■	■
	Peak	■	■
	Peak to peak	■	■
	Bottom	■	■
	Self-trigger	■	■
	Calibration	■	–
	Signal scaling	–	■
	PC-software	■	■
	Application	Mirror	■
Glass		■	■
Metal		■	■
Plastic		■	■
Black rubber		■	■
Paper		■	■
Supply voltage	VDC	21.6 to 26.4 VDC	24 VDC
Control I/O	4 to 20 mA	■	■
	1 to 5 VDC	-10 to +10 V	■
	Judgement output High/Pass/Low	■	■
	Trigger	■	■
Communication	RS-232C	■	■
	USB 2.0	■	–

■ Standard    □ Available    – No/not available

\* For unit specifics see data sheets.

## 2D Measurement Sensor

The ZG2 sensor measures the height and width of entire objects simultaneously, using a wide laser beam.

- All-in-one controller with built-in LCD display
- Measure entire shapes in 2D, X and Z axis
- Immediate live feedback
- Fast 5 ms sampling time
- Accuracy as fine as 0.25  $\mu\text{m}$



## Ordering Information

### Sensing Heads

Measurement mode	Measurement range regular reflective	Measurement range diffuse reflective	Beam size/ measuring region	Resolution X dir/Z dir	FDA laser class	Model
Regular reflective	22.3 +/-0.5 mm	10.6 +/-0.4 mm	3 mm	5 $\mu\text{m}$ / 0.25 $\mu\text{m}$	Class II	ZG2-WDS3VT 0.5M
						ZG2-WDS3VT 2M
Diffuse reflective	44 +/-2 mm	50 +/-3 mm	8 mm	13 $\mu\text{m}$ / 1 $\mu\text{m}$	Class IIIb	ZG2-WDS8T 0.5M
						ZG2-WDS8T 2M
	94 +/-10 mm	100 +/-12 mm	22 mm	35 $\mu\text{m}$ / 2.5 $\mu\text{m}$		ZG2-WDS22 0.5M
						ZG2-WDS22 2M
	mode not available	210 +/-48 mm	70 mm	111 $\mu\text{m}$ / 6 $\mu\text{m}$		ZG2-WDS70 0.5M
ZG2-WDS70 2M						

### Controller

Description	Power supply	Analog output (Switch selectable)	Discrimination output function	Output type	Model
Controller	24 VDC	4 to 20 mA, -10 to 10 VDC	All Pass/NG/ Error	NPN	ZG2-WDC11
				PNP	ZG2-WDC41
				NPN	ZG2-WDC11A
				PNP	ZG2-WDC41A

Note: Models with 'A' suffix includes Smart Monitor ZG Set-up Software.

### Accessories

Extension cables, Software, Communications cables, Mounting adapters, and Controller Link connector.

## Scalable Precision Laser Measurement Sensor

Smart ZS-L sensor offers high-precision, high-speed and high-sensitivity inspections and detects nearly all surfaces.

- Sensitive enough to measure thickness of coating or sealer on glass
- High resolution of 0.25  $\mu\text{m}$
- Fast response time of 110  $\mu\text{s}$  for accurate measurements of moving work pieces
- Sensor head with 2D-CMOS technology delivers high dynamic sensing range to measure black rubber, plastic, shiny glass and mirror surfaces



## Ordering Information

### Sensing Heads

Sensing method	Measurement center distance	Measurement range	Beam type	Beam diameter	Resolution*	Model
Diffuse reflective	50 mm	$\pm 5$ mm	50 - Line	900 x 60 $\mu\text{m}$	0.8 $\mu\text{m}$	ZS-LD50
		$\pm 15$ mm	50S - Spot	50 $\mu\text{m}$		ZS-LD50S
	80 mm	50 mm +/- 5 mm	80 - Line	900 x 60 $\mu\text{m}$	2 $\mu\text{m}$	ZS-LD80
	130 mm	$\pm 15$ mm	130 - Line	900 x 70 $\mu\text{m}$	3 $\mu\text{m}$	ZS-LD130
	200 mm	$\pm 50$ mm	200 - Line	900 x 100 $\mu\text{m}$	5 $\mu\text{m}$	ZS-LD200
	350 mm	$\pm 135$ mm	350S - Spot	240 $\mu\text{m}$ dia.	20 $\mu\text{m}$	ZS-LD350S
Regular reflective	20 mm	$\pm 1$ mm	20T - Line	900 x 25 $\mu\text{m}$	0.25 $\mu\text{m}$	ZS-LD20T
		20 mm +/- 1 mm	20ST - Spot	25 $\mu\text{m}$		ZS-LD20ST
	40 mm	$\pm 2.5$ mm	40T - Line	2000 x 35 $\mu\text{m}$	0.4 $\mu\text{m}$	ZS-LD40T

\*Resolution is the peak-to-peak displacement conversion value in the displacement output at the measuring center distance in high-precision mode, when the number of samples to average is set to 128, and the measuring mode is set to high-resolution mode. The standard work piece is white aluminum ceramic for diffuse reflection heads and glass in the regular reflection heads.

## Controllers

Description	Supply voltage	Control outputs	Model
Sensor Controllers	24 VDC	NPN outputs	ZS-LDC11
		PNP outputs	ZS-LDC41
Multi-Controllers for Calculation	24 VDC	NPN outputs	ZS-MDC11
		PNP outputs	ZS-MDC41
Data Storage Units Support Data Logging	24 VDC	NPN outputs	ZS-DSU11
		PNP outputs	ZS-DSU41

## Accessories

Extension cables, Software, Communications cables, Mounting adapters, and Controller Link connector.

## High-Precision Long Distance Laser Measurement Sensors

High performance sensors support critical quality inspection with precise measurements over long distances.

- Sensor heads support measuring center distances from 20 to 1,500 mm
- Achieves a maximum high resolution of 0.25  $\mu\text{m}$
- Solve tough inspection problems: Stable measurement of black rubber, black resin, glass and metal sheets, and printed circuit boards
- Fast response time of 110  $\mu\text{s}$  for accurate measurements of moving work pieces



## Ordering Information

### Sensing Heads

Sensing method	Measuring range [Sensing distance]	Beam size/ measuring region	Resolution	FDA laser class	Model
Regular	20 mm $\pm$ 1 mm	1.0 mm x 20 $\mu\text{m}$	0.25 $\mu\text{m}$	Class II	ZS-HLDS2T 2M
Diffuse	5.2 mm $\pm$ 1 mm				ZS-HLDS5T 2M
Regular	50 mm $\pm$ 5 mm	1.0 mm x 30 $\mu\text{m}$	0.1 $\mu\text{m}$		ZS-HLDS10 2M
Diffuse	44 mm $\pm$ 4 mm				ZS-HLDS60
Regular	100 mm $\pm$ 20 mm	3.5 mm x 60 $\mu\text{m}$	1.0 $\mu\text{m}$		ZS-HLDS150
Diffuse	94 mm $\pm$ 16 mm				
Regular	600 mm $\pm$ 350 mm	16 mm x 0.3 mm	8 $\mu\text{m}$ @ 250 mm, 40 $\mu\text{m}$ @ 600 mm		
	1500 mm $\pm$ 500 mm	40 mm x 1.5 mm	500 $\mu\text{m}$		

### Series Sensor Heads for Nozzle Gaps

Optical system	Sensing distance	Beam shape	Beam diameter	Resolution	Model
Regular reflective models	10 $\pm$ 0.5 mm	Line beam	900 x 25 $\mu\text{m}$	0.25 $\mu\text{m}$	ZS-LD10GT
	15 $\pm$ 0.75 mm				ZS-LD15GT

### Series Sensor Controllers

Shape	Supply voltage	Control outputs	Model
	24 VDC	NPN outputs	ZS-HLDC11
		PNP outputs	ZS-HLDC41

## Accessories

Extension cables, Software, Communications cables, Mounting adapters, Controller Link and Controller options.



## Smart, Fast Laser Measurement Sensor

Smart ZX-L offers simple setup and measurement for applications where high resolution and fast response time are required. A wide range of interchangeable sensor heads provides great flexibility in solving demanding applications.

- Small and light sensor heads for easy integration
- High-speed response time of 150  $\mu$ s
- Easy sensor head replacement
- Scalability through a modular platform concept



## Ordering Information

### Reflective Sensing Heads

Sensing method	Sensing distance	Beam shape	Resolution	Dimensions (H x W x D mm)	Model
Diffuse reflective	40 $\pm$ 10 mm	Spot, 50 mm dia.	2 $\mu$ m	39 x 33 x 17	ZX-LD40
	100 $\pm$ 40 mm	Spot, 100 mm dia.	16 $\mu$ m		ZX-LD100
	300 $\pm$ 200 mm	Spot, 300 mm dia.	300 $\mu$ m		ZX-LD300
	40 $\pm$ 10 mm	Line, 75 $\mu$ m x 2 mm	2 $\mu$ m		ZX-LD40L
	100 $\pm$ 40 mm	Line, 150 $\mu$ m x 2 mm	16 $\mu$ m		ZX-LD100L
	300 $\pm$ 200 mm	Line, 450 $\mu$ m x 2 mm	300 $\mu$ m		ZX-LD300L
Regular reflective	30 $\pm$ 2 mm	Spot, 75 mm dia.	0.25 $\mu$ m	45 x 55 x 25	ZX-LD30V
		Line, 100 $\mu$ m x 1.8 mm			ZX-LD30VL

### Through-beam Sensing Heads

Sensing method	Sensing distance	Measuring width	Resolution	Dimensions (H x W x D mm)	Model
Through-beam	0 to 2000 mm	1 mm dia.	4 $\mu$ m	15 x 15 x 34 emitter; 15 x 15 x 19 receiver	ZX-LT001
		5 mm dia.		20 x 20 x 42 emitter; 20 x 20 x 25 receiver	ZX-LT005
	0 to 500 mm	10 mm dia.	20 x 64 x 68 emitter; 20 x 64 x 58 receiver	ZX-LT010	
		30 mm dia.	20 x 64 x 58 receiver	ZX-LT030	
			12 $\mu$ m		

### Amplifiers

Description	Power supply	Analog output (Switch selectable)	Discrimination output function	Output type	Model
Amplifier with 2 m cable	12 to 24 VDC	4 to 20 mA, 1 to 5 VDC, 0 to 5 VDC, $\pm$ 4 VDC, $\pm$ 5 VDC	High, Pass, Low	NPN	ZX-LDA11N 2M
				PNP	ZX-LDA41N 2M

### Accessories

Please refer to data sheet for Attachments, Extension cables, Software, Calculating unit and Communications module.



## CMOS Laser Displacement Sensor with Built-in Amplifier

Smart sensor for simple measurements that do not require additional equipment for configuration. All-in-one laser now provides ease of use and stable measurements for any type of work piece. Different sensing distance ranges provide a solution for every application.

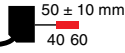
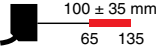

- Amplifier setup built into laser sensor
- Long distance model up to 1,000mm
- Pre-wired connector version allows extension up to 20m
- IP67 heads and Robotic cables

## Ordering Information

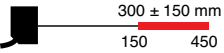
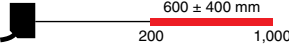
Shape	Spot diameter	Connection method	Cable length	Sensing distance	NPN output model	PNP output model
	0.17 mm	Pre-wired	2 m		ZX1-LD50A61 2M	ZX1-LD50A81 2M
			5 m		ZX1-LD50A61 5M	ZX1-LD50A81 5M
		Pre-wired connector	0.5 m		ZX1-LD50A66 0.5M	ZX1-LD50A86 0.5M
	0.33 mm	Pre-wired	2 m		ZX1-LD100A61 2M	ZX1-LD100A81 2M
			5 m		ZX1-LD100A61 5M	ZX1-LD100A81 5M
		Pre-wired connector	0.5 m		ZX1-LD100A66 0.5M	ZX1-LD100A86 0.5M
	0.52 mm	Pre-wired	2 m		ZX1-LD300A61 2M	ZX1-LD300A81 2M
			5 m		ZX1-LD300A61 5M	ZX1-LD300A81 5M
		Pre-wired connector	0.5 m		ZX1-LD300A66 0.5M	ZX1-LD300A86 0.5M
	0.56 mm	Pre-wired	2 m		ZX1-LD100A61 2M	ZX1-LD100A81 2M
			5 m		ZX1-LD100A61 5M	ZX1-LD100A81 5M
		Pre-wired connector	0.5 m		ZX1-LD100A66 0.5M	ZX1-LD100A86 0.5M

## Extension Cables

Order extension cables for Pre-wired Connector Models only.

Cable length	Model
10 m	ZX0-XC10R
20 m	ZX0-XC20R

## CMOS Laser Displacement Sensor

This next generation smart sensor provides stable measurements with ease of use. Achieve accurate measurements for distance and thickness calculations even with product in motion. The CMOS sensor provides repeatable measurements for any color or surface condition.

- 11 Segment display for easy configuration
- World's smallest CMOS head with laser life display
- 4 bank function for easy setup changeover
- IP67 heads and robotic cables



## Ordering Information

### Sensor Heads

Appearance	Optical system	Beam shape	Sensing distance	Resolution	Model	
	Diffuse reflective	Line beam		1.5 μm	ZX2-LD50	
		Spot beam			ZX2-LD50L	
		Line beam			5 μm	ZX2-LD100
		Spot beam				ZX2-LD100L
	Regular reflective	Spot beam		1.5 μm	ZX2-LD50V	

### Amplifiers

Description	Power supply	Analog output (Switch selectable)	Discrimination output function	Output type	Model
Amplifier with 2 m cable	12 to 24 VDC	4 to 20 mA, 1 to 5 VDC, ±5 VDC	High, Pass, Low	NPN	ZX2-LDA11 2M
				PNP	ZX2-LDA41 2M

### Sensor Head Extension Cables

Length	Model
1m	ZX2-XC1R
4m	ZX2-XC4R
9m	ZX2-XC9R
20m	ZX2-XC20R

### Calculating Unit

Appearance	Model
	ZX2-CAL

### Mounting Brackets

Contents	Applicable sensor heads	Model
Mounting bracket: 1	ZX2-LD50V, ZX2-LD50L, ZX-LD50	E39-L178
Nut plate: 1 Phillips screws (M3x30): 2	ZX-LD100L, ZX-LD100	E39-L179

## Wide Laser Beam CCD Measurement Sensor

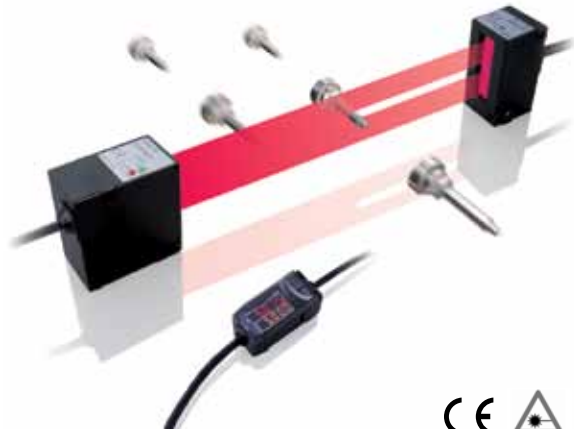

Now you can accurately and reliably get precision measurements of 10µm at a distance of up to 500 mm by using the ZX-GT. The ZX-GT provides unparalleled measurement precision with high-speed measurement of 2,000 samples per second. The ZX-GT's ability to measure glass and mirror surfaces along with its "Smart Recipe" PC software, makes the ZX-GT the most powerful and easy to use measurement sensor in its class.



- 10 µm accuracy by 500 mm range
- High-speed processing of 2,000 images per second ensures fast, accurate in-line measurements
- Dedicated glass detection function
- "Smart Recipe" software makes setup easy

## Ordering Information

### Sensor

Appearance	Optical system	Measuring width	Sensing distance	Resolution	Output type	Model
	Through-beam	28 mm	0 to 500 mm	10 µm	NPN	ZX-GT28S11
					PNP	ZX-GT28S41
			40 mm		NPN	ZX-GT2840S11
					PNP	ZX-GT2840S41

### Amplifiers

Appearance	Power supply	Output type	Model
	DC	NPN	ZX-GTC11
		PNP	ZX-GTC41

### Accessories

Please refer to data sheet for Extension cables, Software, Calculating unit and Communications module.

## Smart Inductive Displacement Sensor

Smart ZX-E offers simple setup for applications requiring non-contact displacement measurements of metal objects. A wide range of interchangeable sensor heads provides great flexibility in solving demanding applications.

- Compact inductive sensor heads for easy integration
- High-speed response time of 150  $\mu$ s
- Easy sensor head replacement
- Scalability through a modular platform concept



## Ordering Information

### Inductive Sensing Heads

Shape	Dimensions	Sensing distance	Resolution	Model
Unthreaded cylindrical	3 dia. x 18 mm	0.5 mm	1 $\mu$ m	ZX-EDR5T
	5.4 dia. x 18 mm	1 mm		ZX-ED01T
	8 dia. x 22 mm	2 mm		ZX-ED02T
Threaded cylindrical	M10 x 22 mm	2 mm		ZX-EM02T
	M18 x 46.3 mm	7 mm		ZX-EM07MT
Flat	30 x 14 x 4.8 mm	4 mm		ZX-EV04T
Heat-resistant, cylindrical	M12 x 22 mm	2 mm	ZX-EM02HT	

### Amplifiers

Description	Power supply	Analog output (Switch selectable)	Discrimination output function	Output type	Model
Amplifier with 2 m cable	12 to 24 VDC	4 to 20 mA, 1 to 5 VDC, 0 to 5 VDC, $\pm$ 4 VDC, $\pm$ 5 VDC	High, Pass, Low	NPN	ZX-EDA11 2M
				PNP	ZX-EDA41 2M

### Accessories

Please refer to data sheet for Mounting brackets, Extension cables, Software, Calculating unit and Communications module.

## Smart Contact Displacement Sensor

Smart ZX-T offers simple setup for applications requiring high-precision contact displacement measurements to verify part shape and orientation.

- Slim sensor heads make it easy to integrate
- Fast response time of 1 ms
- Multipoint measurement with up to 7 sensors
- Dust-tight linear ball bearing construction assures long service life: 10 million mechanical operations minimum



## Ordering Information

### Contact Sensing Heads

Type	Sensing distance	Resolution	Tip size	Dimensions (sensing head)	Model
Short type	1 mm	0.1 $\mu$ m	4.5 dia. mm	57.1 L x 6 dia. mm	ZX-TDS01T
Standard type	4 mm			86 L x 6 dia. mm	ZX-TDS04T
Low-load type				ZX-TDS04T-L	
Standard type	10 mm	0.4 $\mu$ m	5 dia. mm	123 L x 8 dia. mm	ZX-TDS10T
Ultra-low-load type			7.5 dia. mm	132.15 L x 8 dia. mm	ZX-TDS10T-L
Vacuum retracting type			5 dia. mm	129.5 L x 8 dia. mm	ZX-TDS10T-V
Vacuum retracting/Air push type			7 dia. mm	124.5 L x 8 dia. mm	ZX-TDS10T-VL

### Amplifiers

Description	Power supply	Analog output (Switch selectable)	Discrimination output function	Output type	Model
Amplifier with 2 m cable	12 to 24 VDC	4 to 20 mA, 1 to 5 VDC, 0 to 5 VDC, $\pm$ 4 VDC, $\pm$ 5 VDC	High, Pass, Low	NPN	ZX-TDA11 2M
				PNP	ZX-TDA41 2M

### Accessories

Please refer to data sheet for Actuator options, Mounting brackets, Extension cables, Software, Calculating unit and Communications module.

## High Resolution, Digital Proximity Sensor with Separate Amplifier

Designed for highly repeatable, precise positioning, this sensor picks up where standard inductive proximity sensors leave off. E2C-EDA provides the increased resolution, linearity and repeatability to measure tolerances in-line to maintain consistent quality.



- Simple and reliable measurements with micron-level resolution
- Two clear, large and easy-to-read digital displays on the amplifier simplify setup and monitoring
- Slim amplifier allows gang mounting; connector versions reduce wiring

## Ordering Information

### Sensor Heads

Type	Shape	Dimensions	Sensing distance	Repeat accuracy	Model
Shielded	Cylindrical	3 dia. x 18 L mm	0.6 mm	1 µm	E2C-EDR6-F See note 2
		5.4 dia. x 18 L mm	1 mm		E2C-ED01-□ See notes 1 & 2
		8 dia. x 22 L mm	2 mm	2 µm	E2C-ED02-□ See notes 1 & 2
	Screw	M10 x 22 L mm	5 mm		E2C-EM02-□ See notes 1 & 2
	Flat	30 L x 14 W x 4.8 H mm	7 mm	E2C-EV05-□ See notes 1 & 2	
Unshielded	Screw	M18 x 46.3 L mm	2 mm	5 µm	E2C-EM07M-□ See notes 1 & 2
Heat-resistant	Screw	M12 x 22 L mm	2 mm	2 µm	E2C-EM02H See note 2

Note 1. A protective Spiral Tube is provided with models ending in the suffix -S

Note 2. Two cable lengths are available

- Overall length of the standard length type: 2.5 m, length from head to amp 2.0 m with no suffix
- Overall length of the free cut type: 3.5 m, length from head to amp: 0.5m with -F suffix (3 dia : free cut type, Heat-resistant type: standard length only )

## Amplifier Units - Cable and Connector versions

Connection	Description	Functions	Model	
			NPN output	PNP output
Pre-wired	Twin output	Area output, differential operation, open circuit detection	E2C-EDA11 2M	E2C-EDA41 2M
	External input	Remote setting, differential operation	E2C-EDA21 2M	E2C-EDA51 2M
Connector*	Twin output	Area output, differential operation, open circuit detection	E2C-EDA6	E2C-EDA8
	External input	Remote setting, differential operation	E2C-EDA7	E2C-EDA9

\*Amplifier Units with Connectors require Unit Connectors to be ordered separately. 1 Master Connector + Slave Connectors for multiple con

## Unit Connections

Name	Cable length	No. of conductors	Model
Master Connector	2 m	4	E3X-CN21
Slave Connector		2	E3X-CN22

## Variable Laser Beam Sensors

The E3C-LDA sensors for high-speed gauging applications combine compact Class II laser sensing heads with slim DIN-mount amplifiers.

- Sensing heads offer variable focal point and optical axis alignment
- Safe Class II lasers require no special protective hardware
- Dual digital display on the amplifier simplifies setup and monitoring
- Selectable detection modes with response speed as fast as 100  $\mu$ s



## Ordering Information

### Sensing Heads

Sensing method	Beam shape	Sensing distance	Dimensions H x W x D mm	Model
Diffuse reflective	Spot, 0.8 mm max.	30 mm to 1 m	25 x 12.8 x 33	E3C-LD11
	Line, 33 mm L			E3C-LD21
	Area, 33 x 15 mm		27 x 13.2 x 36	E3C-LD31
Coaxial retro-reflective with mirror surface rejection	Variable spot (0.8 mm dia.)	Up to 7 m with E39-R12	25 x 12.8 x 39	E3C-LR11
	Line, 28 mm L	Up to 1.7 m with E39-R12		E3C-LR11 + E39-P31
	Area, 28 x 16 mm	Up to 900 mm with E39-R12		E3C-LR11 + E39-P41
	Fixed spot (2 mm dia.)	Up to 7 m with E39-R12		E3C-LR12

### Amplifiers

Connector	Description	Functions	Output ratings	Model	
				NPN output	PNP output
Pre-wired models	Analog + Discrete outputs	Area output, differential operation	1 to 5 VDC, 50 mA at 26.4 VDC	E3C-LDA11AN	E3C-LDA41AN
	Two discrete outputs	Area output, differential operation, self-diagnostics	2 x 50 mA at 26.4 VDC	E3C-LDA11	E3C-LDA41
	External input + Discrete output	Built-in counter, differential operation, remote setting	1 x 50 mA at 26.4 VDC	E3C-LDA21	E3C-LDA51
Connector	Two discrete outputs	Area output, differential operation, self-diagnostics	2 x 50 mA at 26.4 VDC	E3C-LDA6	E3C-LDA8
	External input + Discrete output	Built-in counter, differential operation, remote setting	1 x 50 mA at 26.4 VDC	E3C-LDA7	E3C-LDA9

### Connectors

Description	Compatible amplifiers	Cable length	Conductors	Model
Master connector (for first unit)	E3C-LDA6, E3C-LDA7, E3C-LDA8, E3C-LDA9	2 m	3	E3X-CN11
Slave connector (for second and additional units)			4	E3X-CN21
			1	E3X-CN12
			2	E3X-CN22



# Measurement Sensors

---

## Contents

<b>Selection Guide</b>		M-ii
<b>Ultrasonic Sensors</b>		
<b>E4A-3K</b>	Long range reflective block-style	M-1
<b>E4B</b>	Compact block style, distance settable models	M-1
<b>E4C</b>	Cylindrical 18 mm sensor with separate amplifier	M-2
<b>E4PA</b>	Ultrasonic displacement sensors in M30 cylindrical housing	M-2
<b>E4C-UDA</b>	Cylindrical 18 mm sensor with advanced digital amplifier	M-3



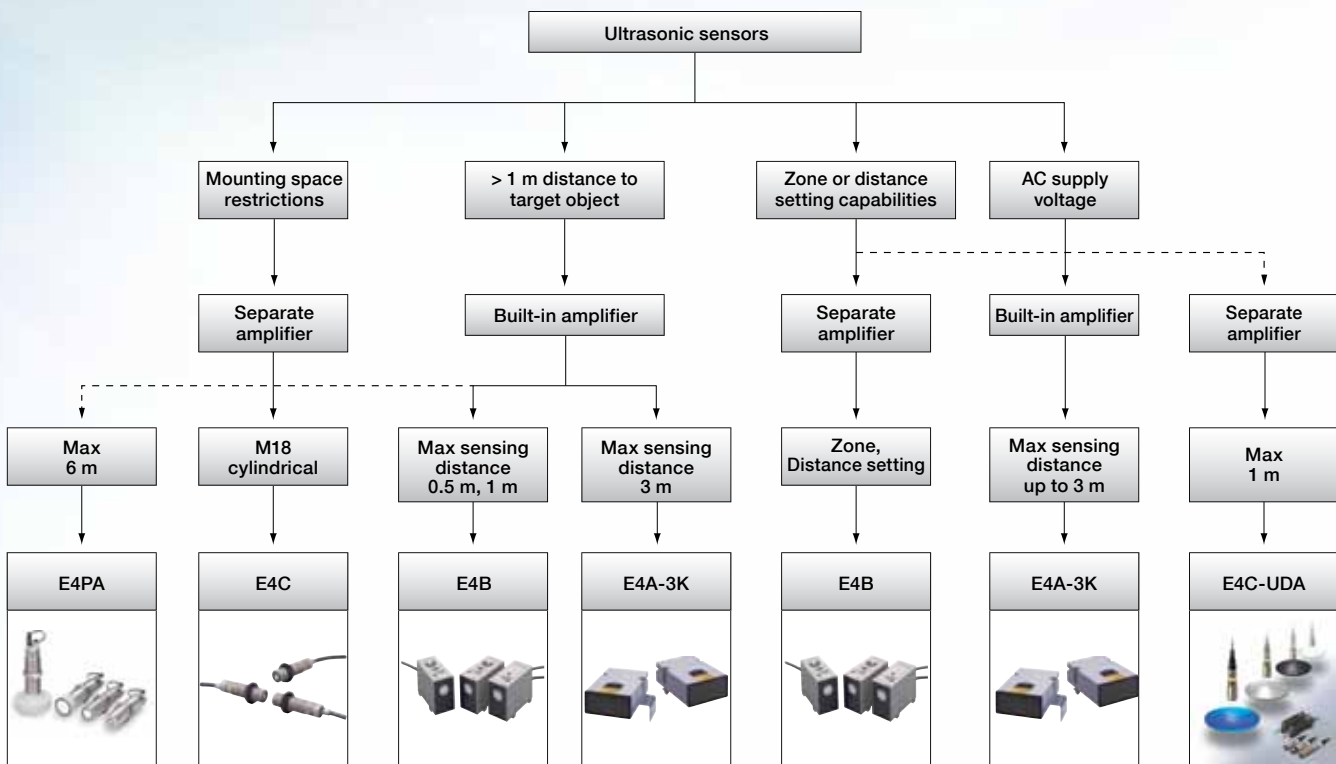

## PERFORMANCE OPTIMIZED FOR YOUR APPLICATION

Ultrasonic waves are used to enable stable detection of transparent objects, such as transparent films, glass bottles, plastic bottles, and plate glass, using Through-beam or Reflective Sensors.

Transparent objects are usually produced with the goal to provide best visibility of the products they contain. This makes these objects also difficult to detect with optical sensing principles. While photoelectric sensors are the preferred choice for the detection of transparent objects, ultrasonic sensors are able to detect products regardless of color, texture or glossiness at long range. Ultrasonic sensors can also detect powder in storage tanks. Omron Automation and Safety offers reliable sensing solutions for packaging and material handling to meet the required task.



# Selection Table

Category		Ultrasonic Sensors				
						
Model		E4A	E4B	E4C	E4C-UDA	E4PA
Amplifier type		Built-in amplifier	Built-in amplifier	Separate amplifier	Built-in amplifier	Built-in amplifier
Features		<ul style="list-style-type: none"> <li>• Ultrasonic reflective</li> <li>• Mutual interference protection</li> <li>• Clear material detection</li> <li>• Photo sensitive film sensing</li> </ul>	<ul style="list-style-type: none"> <li>• Ultrasonic through-beam and reflective</li> <li>• Narrow 8 degree beam</li> <li>• Zone and setting distance models</li> </ul>	<ul style="list-style-type: none"> <li>• Ultrasonic through-beam</li> <li>• Compact threaded body</li> <li>• Mutual interference protection</li> </ul>	<ul style="list-style-type: none"> <li>• M18 threaded body</li> <li>• Simple and reliable detection of difficult targets</li> <li>• Easy to read display on amplifier</li> <li>• Yellow indicator on sensor head</li> </ul>	<ul style="list-style-type: none"> <li>• M30 threaded body</li> <li>• Analog output</li> <li>• Long range – up to 6 m</li> <li>• Simple setting plug for adjustment</li> </ul>
Detection method and sensing distance	Through-beam type	–	1 m, 500 mm	500 mm	–	See data sheet
	Reflective	0.3 to 3 m	200 to 700 mm, 50 to 200 mm	100 to 350 mm	See data sheet	See data sheet
Supply voltage		120 and 240 VAC; 12 to 24 VDC	12 to 24 VDC	12 to 24 VDC	12 to 24 VDC	10 to 30 VDC
Control outputs	AC	3 A Relay, SPDT	–	–	–	–
	DC	–	100 mA NPN or PNP open collector	100 mA, NPN/PNP open collector, selectable	NPN open coil, -N voltage output 1.5 V	40 - 70 mA, voltage 0 - 10 V
Response time		250 ms	10 ms	10 ms (200 Hz)	See data sheet	Sensor specific
Materials		Plastic, ABS	Plastic, ABS	Plastic, ABS	PBT	Stainless, PBT
Enclosure rating		IP60	IP66	• IP66 sensor • IP40 amplifier	IP65	IP65

M

## Long Range Ultrasonic Sensor

- Block style sensor uses reflective technique to detect clear materials and photosensitive film
- Long sensing distance: 0.3 to 3 m
- Background suppression for accurate sensing
- Relay output rated 3A at 240 VAC/24 VDC
- Fast alignment troubleshooting with stable operation check function
- 250 ms response time
- Mutual interference protection built in
- Choose 12-24 VDC or 120/240 VAC models
- Enclosure rated IP60
- Measures 104 H x 50 W x 150 D mm



# E4B Ultrasonic Sensors

## Compact Block Style, Distance Settable Models

- Through-beam models with 1 m and 0.5 m ranges for long range applications
- Zone models detect objects at 20-70 cm while suppressing interference from background objects
- Narrow beam angle of 8° detects objects as small as 2 x 2 cm, all models
- 200 kHz provides high immunity from environmental noise
- 10 ms response time
- NPN or PNP open collector output, 100 mA at 30 VDC Supply voltage: 12-24 VDC
- User-selectable normally open and normally closed operation
- Enclosure rated IP66
- Measures 61 H x 35 W x 79 D mm



## Threaded Cylindrical Sensor with Remote Amplifier

- Ultrasonic 18 mm cylindrical sensor with remote DIN-rail mount amplifier
- Long sensing distances:  
Through-beam: 0.5 m
- NPN/PNP output, switch selectable, rated 100 mA at 24 VDC
- 10 ms response time
- Mutual interference protection for multiple units
- Supply voltage: 12-24 VDC
- IP66 for sensor; IP40 for amplifier



- Sensor: M18 x 75 mm long with 2 m shielded cable
- Amplifier: 75 H x 22.5 W x 80 D mm

# E4PA Measurement Sensors

## Ultrasonic Displacement Sensors

Threaded cylindrical ultrasonic displacement sensors accurately measure objects regardless of color. They provide highly repeatable, highly linear measurements over long distances.

- Reliable repeatability of 0.1% FS max.
- Ultrasound detection is not affected by object color
- Long detection ranges, up to 6 meters
- Easy-to-install M30 threaded body



M

## Ordering Information

Measurement range	Applied frequency	Response time	Dimensions mm	Model
50 to 500 mm	Approx. 180 kHz	63 ms max.	M30 D x 141.5 L (92 threaded)	E4PA-LS50-M1-N
120 to 2000 mm	Approx. 195 ms	100 ms max.		E4PA-LS200-M1-N
240 to 4000 mm	Approx. 440 ms	300 ms max.	40 D face x 155.5 L (81 threaded)	E4PA-LS400-M1-N
400 to 6000 mm	Approx. 850 ms	500 ms max.	73 D face x 159.5 L (77.5 threaded)	E4PA-LS600-M1-N

## Ultrasonic Sensor with Separate Digital Amplifier

The E4C-UDA reflective ultrasonic sensors reliably detect a wide variety of work pieces regardless of color, transparency, material and pattern. Use them to detect objects that are difficult or impossible to detect optically or inductively.

- Simple and reliable detection of difficult work targets
- Two clear, large and easy-to-read digital displays on the amplifier simplify setup and monitoring
- Twin output and analog type amplifiers available



## Ordering Information

### Sensor Heads

Shape	Model	Measuring range	Model
M18	Straight	50 to 300 mm	E4C-DS30
	Side view		E4C-DS30L
	Straight	70 to 800 mm	E4C-DS80
	Side view		E4C-DS80L
	Straight	90 to 1000 mm	E4C-DS100

### Amplifiers

Connection	Power supply	Description	Model	
			NPN output	PNP output
Pre-wired, 2 m cable	DC	Voltage Output 1 to 5 V DC Control Output 50 mA max at 26.4 V DC max	E4C-UDA11AN	E4C-UDA41AN
		2 Range Outputs 50 mA max at 26.4 V DC max	E4C-UDA11	E4C-UDA41

## Contents

<b>Selection Guide</b>		N-ii
<b>Vision Sensors</b>		
<b>FQ</b>	Compact vision sensor combining both camera and image processor within one unit, network up to 8 cameras with high image quality without complex operation	N-1
<b>FQ-M</b>	Compact vision sensor with motion tracking for pick-and-place robots	N-2
<b>ZFV-C</b>	Color vision sensor with separate amplifier with built in LCD monitor	N-3
<b>Vision Systems</b>		
<b>ZFX</b>	Vision System with built-in LCD monitor, one or two-camera models and versions with 1D barcode and 2D code reading capabilities	N-4
<b>FZ4</b>	“Real Color” Sensing Technology with over 50 process items. 2 or 4 camera controllers - units available with built-in LCD monitor. Model options available for 300K, 2M or 5M pixel cameras, Network ready for Ethernet and EtherNet/IP. Options also include High Speed Processing, Dual Processors and Advanced Processing Items, including 1D barcode and 2D code reading, and High Dynamic Range (HDR) capabilities	N-6
<b>FJ</b>	Customizable vision system	N-10
<b>FZM1</b>	Vision system with EtherCAT motion control network interface	N-12

<b>Lighting and Accessories</b>		
<b>FL</b>	Lighting	N-13
<b>FZ-LE/ 3Z4S-LE</b>	Lenses	N-14





## VISION SOLUTIONS: EASY AS TOUCH, COMMUNICATE & GO

### LCD monitors allow for setup and immediate image visualization

Vision sensors solve applications by intuitive teach and go procedures.



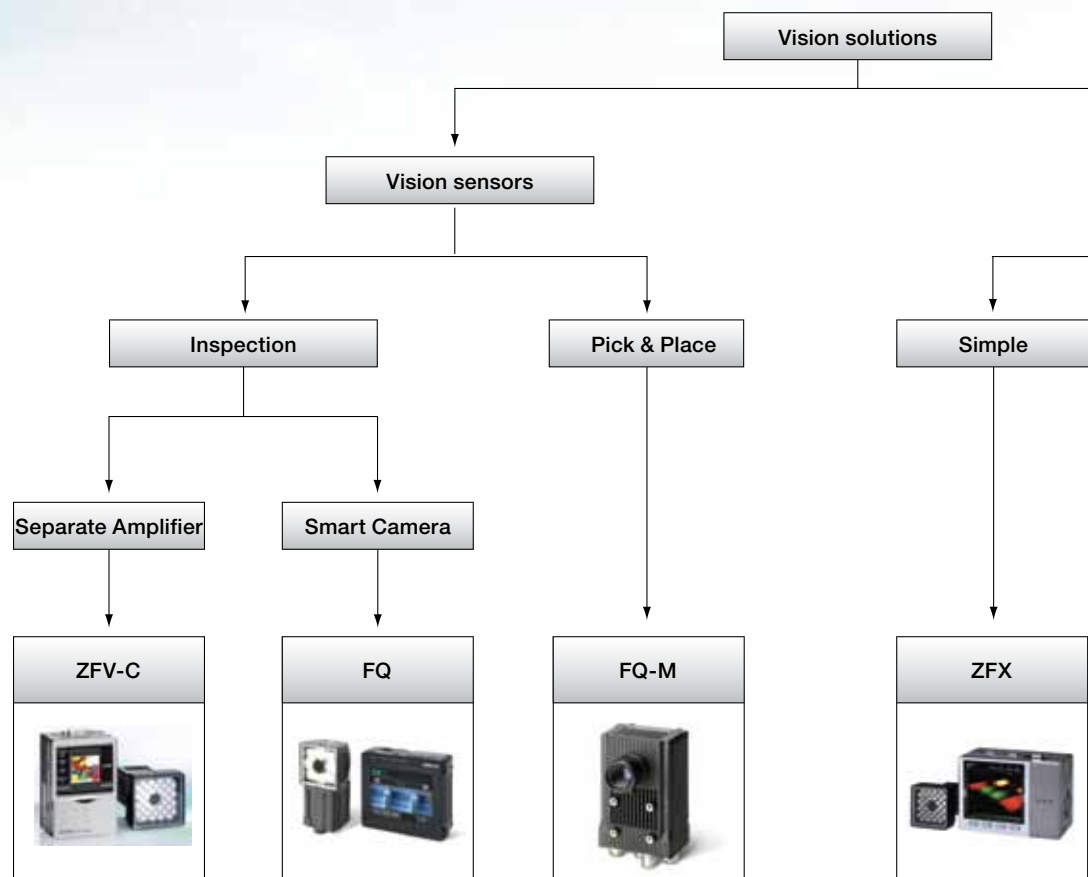

Advanced features of Vision systems allow for image processing, position correction and multiple inspections. Real Color Sensing allows for color inspection by discriminating up to 16.7 million colors. Intelligent Lighting and High Resolution Camera options allow for High-end image quality with both vision sensors and systems.

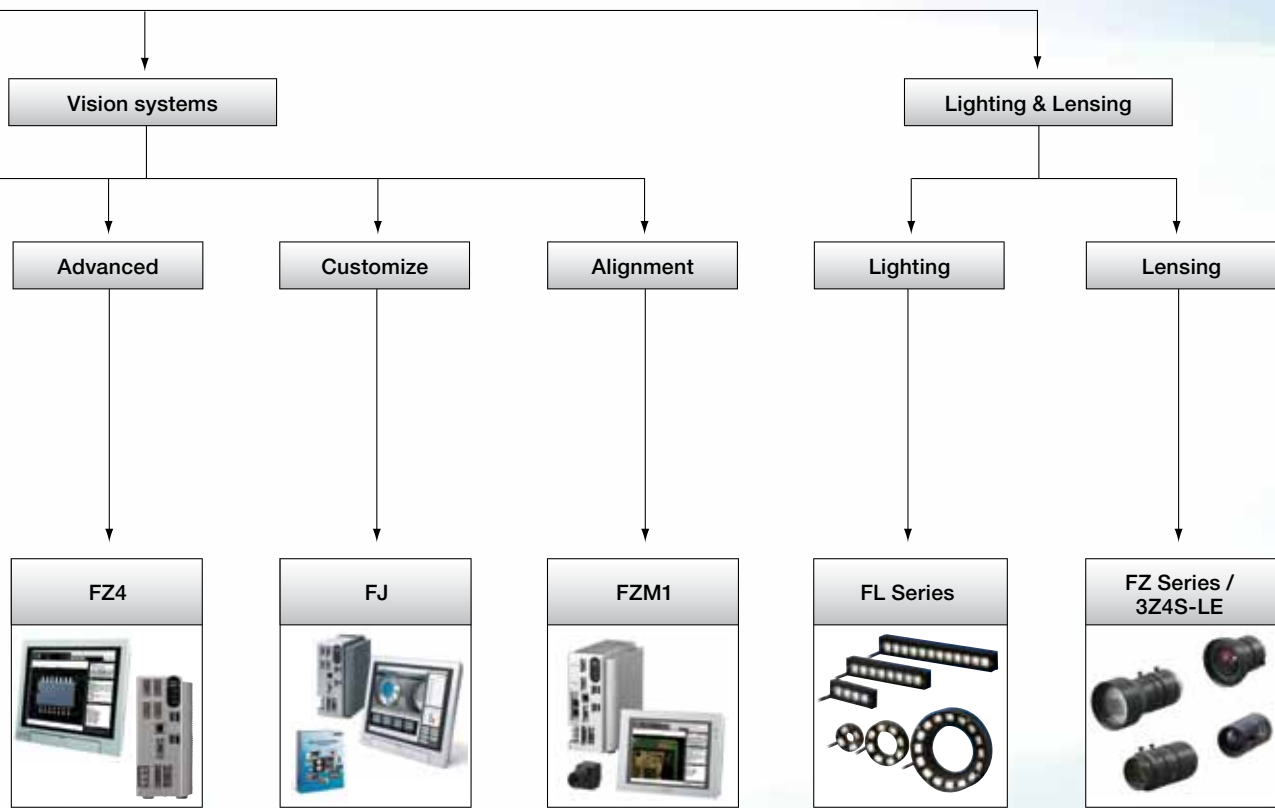
- Smart Vision – High Speed Inspections
- Vision Systems have data trending, logging and image storage for evaluation functions
- The New FQ offers unparalleled vision inspection
- Real color – close to human eye identification and image processing







# Selection Table

		Vision sensors			Vision system
					
Model		ZFV-C	FQ	FQ-M	ZFX
Selection criteria	Number of connectable cameras	1	8 connectable to 1 Touchfinder	2 connectable to 1 Touchfinder	2
	Camera type	Digital color	CMOS	Digital color and monochrome	Digital color and monochrome
	Resolution (usable) Display dots	468x432	752 x 480	752 x 480	up to 608 x 464
	Number of storable configurations	8	8 (FQ-S1) 32 (FQ-S2)	Up to 32	32 per Bank Group
	Number of tools/configuration	1	1 (FQ-S1) 32 (FQ-S2)	32	128
	IP-Rating camera head	IP65/IP67	IP67	IP40	Depend on head, up to IP65/IP67
	Supply voltage	24 VDC	24 VDC	24 VDC	24 VDC
	Features	Image processing tools	Up to eight (hue, area, brightness, width, position, character, count, pattern)	Five (search, color, area, edge position, edge width)	Four (Shape search, Search, Labeling, Edge position)
Image preprocessing		Monochrome, color filter, white balance	High-Dynamic Range (HDR), polarizing filter, white balance	High-Dynamic Range (HDR), White balance	Smoothing, edge enhancement, edge extraction, erosion, dilation, median, background suppression
User interface		On board "teach & go"	On board "teach & go" touch screen	On board "teach & go" touch screen	On board "teach & go" touch screen
Optional PC configuration software		–	■ (PC Tool Touchfinder)	■ (Sysmac Studio)	–
Security tools		Key Lock Function	■	■	■
Communication	RS-232C	■	–	–	■
	USB	■	–	–	■
	Ethernet	–	■	■	■
	EtherCAT	–	–	■	–
	Number of digital I/O	5 in/3 out	7 in/3 out	9 in/5 out	12 in/22 out

■ Standard    □ Available    – No/not available

		Vision systems			
					
Selection criteria	Model	FZ4	FJ	FZM1	
		Number of connectable cameras	4	4 (use FZ cameras)	2
		Camera type	Digital color and monochrome	Digital color and monochrome	Digital color and monochrome
		Resolution (usable) Display dots	from 640 x 480 to 2448 x 2044	from 640 x 480 to 2448 x 2044	from 640 x 480 to 1600 x 1200
		Number of storable configurations	32 per Scene Group	32 per Scene Group	32 per Scene Group
		Number of tools/configuration	limited only by memory space	limited by only memory size	limited by only memory size
		IP-Rating camera head	Depends on camera		
		Supply voltage	24 VDC	24 VDC	24 VDC
Features	Image processing tools	Approx. 70 processing tools for object or defect recognition, measurements, calculations, input/output, display and more. Includes also character recognition and high precision edge code inspection tools	Approx. 70 processing tools for object or defect recognition, measurements, calculations, input/output, display and more. Includes character recognition and high precision edge code inspection tools	Approx. 70 processing tools for object or defect recognition, measurements, calculations, input/output, display and more. Includes also character recognition and high precision edge code inspection tools	
	Image preprocessing	High Dynamic Range (HDR), smoothing, edge enhancement, edge extraction, erosion, dilation, median, background suppression - multiple passes, configurable	High Dynamic Range (HDR), smoothing, edge enhancement, edge extraction, erosion, dilation, median, background suppression - multiple passes, configurable	High Dynamic Range, smoothing, edge enhancement, edge extraction, erosion, dilation, median, background suppression - multiple passes, configurable	
	User interface	■	■	■	
	Optional PC configuration software	■ (Remote operation PC tool)	■ (Remote operation PC tool)	■	
	Security tools	■	■	■	
Communication	RS-232C	■	■	■	
	USB	■	■	■	
	Ethernet	■ EtherNet/IP	■ EtherNet/IP	■	
	EtherCAT	–	–	■	
	Number of digital I/O	11 in/26 out	11 in/26 out	11 in/26 out	

■ Standard    □ Available    – No/not available

## Clear Imaging Quality and Advanced Processing Tools in Easy to Use Interface

Achieve highly reliable inspection results on most challenging surfaces.

- Real Color Sensing – 16.7M Colors
- Integrated High-Power Lighting
- High-Dynamic-Range (HDR) Sensing
- Polarizing Filter Attachment



## Specifications

- Single function models: Offer 1 inspection and no position compensation
- Standard Models: Offer 32 inspections with Position Compensation
- Polarizing Filter Included with all types

## Sensor

Field of view (Horizontal x Vertical)	Installation distance	Single function models		Standard models	
		NPN	PNP	NPN	PNP
7.5 x 4.7 to 13 x 8.2 mm	38 to 60 mm	FQ-S10010F	FQ-S15010F	FQ-S20010F	FQ-S25010F
13 x 8.2 to 53 x 33 mm	56 to 215 mm	FQ-S10050F	FQ-S15050F	FQ-S20050F	FQ-S25050F
29 x 18 to 300 x 191 mm	Short-Distance model: 32 to 380 mm	FQ-S10100N	FQ-S15100N	FQ-S20100N	FQ-S25100N
53 x 33 to 240 x 153 mm	Long-distance model: 220 to 970 mm	FQ-S10100F	FQ-S15100F	FQ-S20100F	FQ-S25100F

## Touch finder

Type	Model
DC power supply	FQ-D30
AC/DC/Battery	FQ-D31 (See Note.)

Note: AC adapter and battery are sold separately. Both accessories are required, see FQ brochure for details.

## Cables (Robotic cable)

Type	Cable length	Model
FQ Ethernet Cables (connect Sensor to Touch Finder, Sensor to PC)	2 m	FQ-WN002
	10 m	FQ-WN010
	20 m	FQ-WN020
I/O Cables	2 m	FQ-WD002
	10 m	FQ-WD010
	20 m	FQ-WD020

## Vision Designed for Motion Tracking with EtherCAT Communication Option

- Fast & precise positioning
- Encoder input for conveyor tracking and calibration
- Shape based object detection
- Smart calibration wizard
- Sysmac Studio software for vision system operation and setting



EtherCAT



## Visions Sensors

Appearance	Network type	Camera type	Output type	Model
	Ethernet data communication	Color	NPN	FQ-MS120
			PNP	FQ-MS125
		Monochrome	NPN	FQ-MS120-M
			PNP	FQ-MS125-M
	EtherCAT data communication	Color	NPN	FQ-MS120-ECT
			PNP	FQ-MS125-ECT
		Monochrome	NPN	FQ-MS120-M-ECT
			PNP	FQ-MS125-M-ECT

Note: For lenses please refer to FZ-LE/3Z4S-LE models in Lighting and Accessories section.

## Touch Finder

Appearance	Description	Power supply	Model
	Optional touch screen setting and monitoring device for FQ-series sensors	DC power supply	FQ-MD30
		AC/DC battery*	FQ-MD31

\* AC Adapter and Battery are sold separately.

## Cables (robotic cable)

Type	Connectors	Cable length	Model
FQ Ethernet and EtherCAT Cables (connects Sensor to Touch Finder, Sensor to PC)	Angle M12 / Straight RJ45	5 m	FQ-MWNL005
		10 m	FQ-MWNL010
	Straight M12 / Straight RJ45	5 m	FQ-WN005
		10 m	FQ-WN010
FQ EtherCAT Cables	Angle M12 / Angle M12	5 m	FQ-MWNEL005
		10 m	FQ-MWNEL010
	Straight M12 / Straight M12	5 m	FQ-MWNE005
		10 m	FQ-MWNE010
I/O Cables	Angle	5 m	FQ-MWDL005
		10 m	FQ-MWDL010
	Straight	5 m	FQ-MWD005
		10 m	FQ-MWD010

## Easy Color Vision System





Color version of the Omron Smart Sensor, the ZFV-C, offers color sensing capabilities for distinguishing colors shapes

- Color digital camera with built-in LED light source
- Eight inspection tools operating in color
- “Teach and Go” setup: uses a color LCD screen and simple menu to reduce setup for inspections to a few simple steps
- The screen shows a live image for instant feedback during both setup and inspection operations



## Ordering Information

### Sensor Heads

Appearance	Type	Sensing distance	Sensing area	Enclosure rating	Model
	Narrow view	34 to 49 mm (variable)	5 x 4.6 mm to 9 x 8.3 mm (variable)	IP65	ZFV-SC10
	Standard	31 to 187 mm (variable)	10 x 9.2 mm to 50 x 46 mm (variable)	IP65	ZFV-SC50
IP67				ZFV-SC50W	
	Wide view	66 to 141 mm (variable)	50 x 46 mm to 90 x 83 mm (H x V)	IP65	ZFV-SC90
IP67				ZFV-SC90W	
	Ultra wide view	114 to 226 mm (variable)	90 x 83 mm to 150 x 138 mm (H x V)	IP65	ZFV-SC150
IP67				ZFV-SC150W	

### Amplifier Units

Appearance	Type	Sensing distance	Sensing area
	20.4 to 26.4 VDC (including ripple)	NPN	ZFV-CA40
		PNP	ZFV-CA45

Note: See data sheet E373-E2-01 for ZFV-C accessories.





## Vision System with Built-In LCD Monitor

- The Omron's new ZFX-C Smart Vision System is a total Image Processing system that includes everything from a camera with an integrated light source to an image processing unit.
- With Omron's newly developed proprietary measurement algorithms, and intuitive programming tools, inspection regions, process and parameter data is easily set with a few steps involving the operation of the touch-color monitor.
- This "Smart" user interface delivers an advanced programming environment, with direct visualization of the inspection process, simplified parameter adjustment are facilitated in a compact, easy to use Color-HMI programming environment.
- The new technology and style of the ZFX-C paves the way to a new era of vision sensors.

## Ordering Information

### Controllers





Appearance	Number of Cameras	Power Supply	Output Type	Standard Tools Model	Standard Tools Plus Linear and 2D Code Model
	1	21.6 - 26.4 VDC	NPN	ZFX-C10	ZFX-C10-CD
	2		PNP	ZFX-C15	ZFX-C15-CD

Appearance	Number of Cameras	Power Supply	Output Type	Expanded Tools Model	Expanded Tools Plus Linear and 2D Code Model
	1	21.6 - 26.4 VDC	NPN	ZFX-C20	ZFX-C20-CD
	2		PNP	ZFX-C25	ZFX-C25-CD

Note: See brochure WW for ZFX accessories.



## Cameras

Appearance	Type	Sensing distance	Sensing area	Model	Remarks		
	Camera with lighting	Monochrome	34 mm to 49 mm	5 mm x 4.9 mm to 9 mm x 8.9 mm (variable)	ZFX-SR10 ZFX-SR10R**	Cable length: 2 m	
			38 mm to 194 mm	10 mm x 9.8 mm to 50 mm x 49 mm (variable)	ZFX-SR50 ZFX-SR50R**		
		Color	34 mm to 49 mm	5 mm x 4.9 mm to 9 mm x 8.9 mm (variable)	ZFX-SC10 ZFX-SC10R**		
			31 mm to 187 mm	10 mm x 9.8 mm to 50 mm x 49 mm (variable)	ZFX-SC50 ZFX-SC50R** ZFX-SC50W*		
			67 mm to 142 mm	50 mm x 49 mm to 90 mm x 89 mm (variable)	ZFX-SC90 ZFX-SC90R** ZFX-SC90W*		
			115 mm to 227 mm	90 mm x 89 mm to 150 mm x 148 mm (variable)	ZFX-SC150 ZFX-SC150R** ZFX-SC150W*		
	1 Camera only	Monochrome	The CCTV lens is selected according to the range of detection and the installation distance		ZFX-S		—
		Color			ZFX-SC		

Note: <sup>1</sup>For lenses please refer to FZ-LE/3Z4S-LE models in Lighting and Accessories section.  
For camera cables, see brochure Q371-E-02 for ZFX.

\* Washdown rating equals IP67

\*\* Robotic cable

## “Real Color” Vision Sensors Maximize Inspection Flexibility

- Mega ARCS Engine: High speed, stable color image processing for accurate inspections/ measurement close to human vision
- High-grade controller tool set includes 1D bar code and 2D code reader, HDR function, and trapezoidal correction
- Wide range of cameras: 300K-pixel, 2- and 5-million pixel high-speed cameras
- Easy-to-use Windows-like GUI menu structure; simulation software offers testing, remote setting
- Communication interfaces: Digital, serial, Ethernet, EtherNet/IP



## System Configuration

### Controllers integrated with LCD

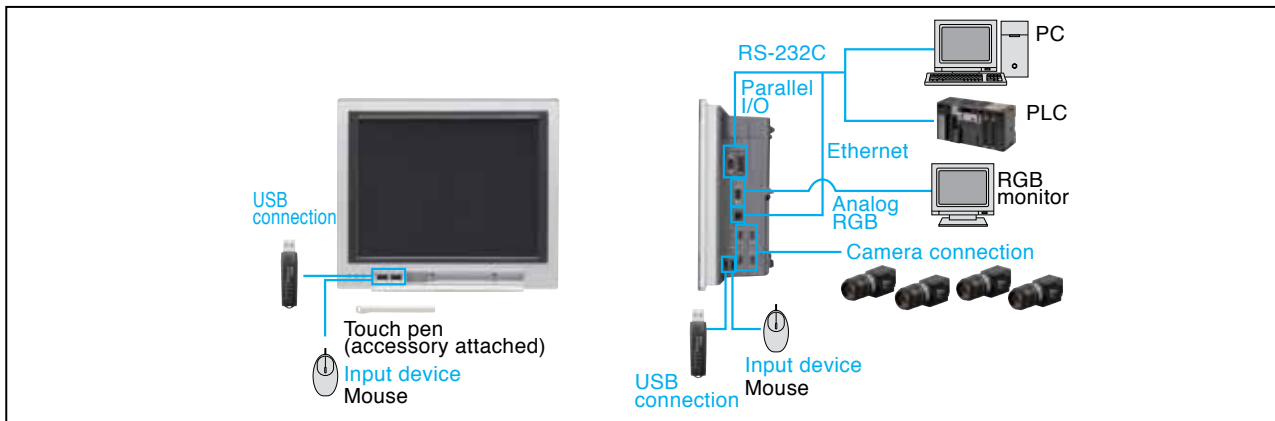

### Box-type Controllers

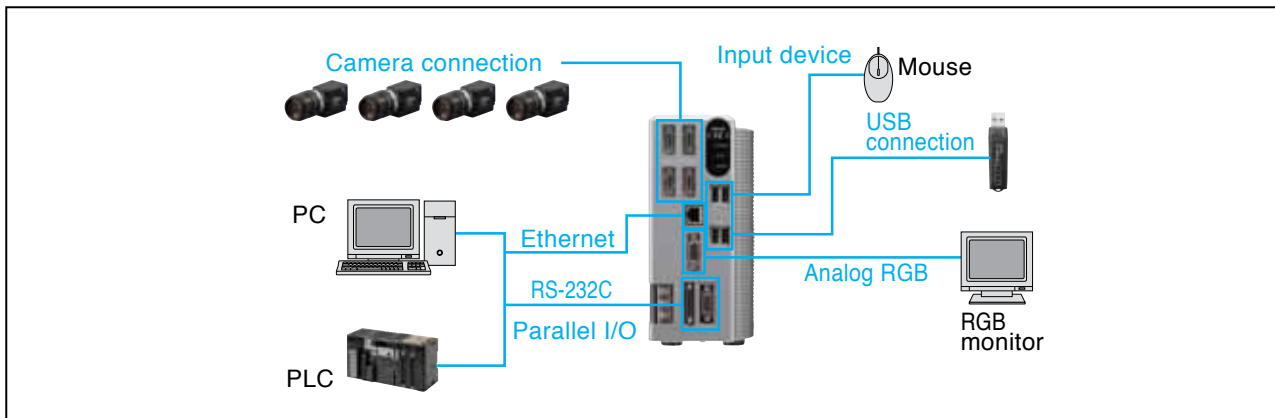



## Lite Controllers

Type	Description	Number of cameras	Remarks	Dimensions (mm)	NPN output model	PNP output model
Lite controllers	Box-type controllers	2	Use FZ-SQ cameras	197 H x 80 W x 182.3 D	FZ4-L350	FZ4-L350-10
		4			FZ4-L355	FZ4-L355-10



Box-type  
Controllers



Controllers with  
Integrated LCD

## Controllers

Type	Description	Number of cameras	Remarks	Dimensions (mm)	NPN output model	PNP output model
Standard controllers	Controllers integrated with LCD	2	With touch pen	260 H x 308 W x 83 D	FZ4-600	FZ4-605
		4		260 H x 308 W x 104 D	FZ4-600-10	FZ4-605-10
	Box-type controllers	2	N/A	190 H x 90 W x 165 D	FZ4-650	FZ4-655
		4			FZ4-650-10	FZ4-655-10
High-grade, standard controllers	Controllers integrated with LCD	2	With touch pen	260 H x 308 W x 83 D	FZ4-H600	FZ4-H605
		4		260 H x 308 W x 104 D	FZ4-H600-10	FZ4-H605-10
	Box-type controllers	2	N/A	190 H x 90 W x 165 D	FZ4-H650	FZ4-H655
		4			FZ4-H650-10	FZ4-H655-10
High-speed, high-grade controllers	Controllers with integrated LCD	2	With touch pen	260 H x 308 W x 83 D	FZ4-H700	FZ4-H705
		4		260 H x 308 W x 104 D	FZ4-H700-10	FZ4-H705-10
	Box-type controllers	2	N/A	190 H x 90 W x 165 D	FZ4-H750	FZ4-H755
		4			FZ4-H750-10	FZ4-H755-10
High-speed controllers	Controllers with integrated LCD	2	With touch pen	260 H x 308 W x 83 D	FZ4-700	FZ4-705
		4		260 H x 308 W x 104 D	FZ4-700-10	FZ4-705-10
	Box-type controllers	2	N/A	190 H x 90 W x 165 D	FZ4-750	FZ4-755
		4			FZ4-750-10	FZ4-755-10
Dual-task, high-speed controllers	Controllers integrated with LCD	2	With touch pen	260 H x 308 W x 83 D	FZ4-1100	FZ4-1105
		4		260 H x 308 W x 104 D	FZ4-1100-10	FZ4-1105-10
	Box-type controllers	2	N/A	190 H x 90 W x 165 D	FZ4-1150	FZ4-1155
		4			FZ4-1150-10	FZ4-1155-10
Dual-task, high-grade, high-speed controllers	Controllers integrated with LCD	2	With touch pen	260 H x 308 W x 83 D	FZ4-H1100	FZ4-H1105
		4		260 H x 308 W x 104 D	FZ4-H1100-10	FZ4-H1105-10
	Box-type controllers	2	N/A	190 H x 90 W x 165 D	FZ4-H1150	FZ4-H1155
		4			FZ4-H1150-10	FZ4-H1155-10

## Cameras

5 million-pixel digital cameras



Color  
FZ-SC5M2

2 million-pixel digital cameras



Color  
FZ-SC2M

300,000-pixel digital cameras



Color  
FZ-SC

High Speed camera 300,000-pixel



Color  
FZ-SHC

Autofocus camera 300,000-pixel



Narrow field of vision  
FZ-SZC15



Black & White  
FZ-S5M2



Black & White  
FZ-S2M



Black & White  
FZ-S



Black & White  
FZ-SH



Wide field of vision  
FZ-SZC100

Type	Description	Color	Features	Dimensions (mm)	Model
Intelligent cameras	Wide field of view	Color	Camera + Zoom, Autofocus lens + Intelligent lighting	100 H x 100 W x 146.7 D	FZ-SLC100
	Narrow field of view	Color		95 H x 90 W x 151.7 D	FZ-SLC15
Autofocus cameras	Wide field of view	Color	Camera + Zoom, Autofocus lens	93 H x 72.2 W x 134 D	FZ-SZC100
	Narrow field of view	Color			FZ-SZC15
High-speed cameras	300,000 pixels	Mono	Lens required	35 H x 35 W x 48.2 D	FZ-SH
		Color			FZ-SHC
Digital cameras	300,000 pixels	Mono	Lens required	28 H x 28 W x 46.3 D	FZ-S
		Color			FZ-SC
	2 million pixels	Mono	Lens required	28 H x 28 W x 53.5 D	FZ-S2M
		Color			FZ-SC2M
5 million pixels	Mono	Lens required	44 H x 44 W x 55 D	FZ-S5M2	
	Color			FZ-SC5M2	
Small, flat digital cameras	300,000 pixels	Mono	CCTV lens required	22 H x 34 W x 16.9 D	FZ-SF
		Color			FZ-SFC
Small, pen type digital cameras	300,000 pixels	Mono	CCTV lens required	M10.5 dia. x 44 L	FZ-SP
		Color			FZ-SPC

Note: For lenses please reference FZ-LE/3Z4S-LE models in Lighting and Accessories section.

## Intelligent Compact Cameras

The compact unit contains both camera and smart lighting.



Type	Description	Color	Features	Dimensions (mm)	Model
Intelligent compact cameras	Wide view (short-distance)	Color	Camera + Lens + Intelligent lighting	46 H x 49 W x 94.8 D	FZ-SQ100N
	Wide view (long-distance)	Color			FZ-SQ100F
	Standard view	Color		46 H x 57 W x 94.8 D	FZ-SQ050F
	Narrow view	Color			FZ-SQ010F

## Cables

Type	Description	Cable length (add to model)	Compatibility	Model
Camera cable	Standard camera cable	2 m, 5 m, 10 m	10 m cable cannot be connected to FZ-SLC or FZ-SZC cameras	FZ-VS_M
	High-flex camera cable	2 m, 5 m, 10 m	10 m cable cannot be connected to FZ-S_2M, FZ-SLC or FZ-SZC cameras	FZ-VSB_M
	Right-angle camera cable	2 m, 5 m, 10 m	10 m cable cannot be connected to FZ-SLC or FZ-SZC cameras	FZ-VSL_M
	Long-distance camera cable	15 m	Cannot be connected to FZ-SLC or FZ-SZC cameras	FZ-VS2 15M
	Long-distance, right angle camera cable	15 m	Cannot be connected to FZ-SLC or FZ-SZC cameras	FZ-VSL2 15M
Cable extension unit	Boosts video signal between cable segments	N/A	Up to 2 extension units and 3 cables can be connected; maximum cable length up to 45 m depending on cameras and cables used	FZ-VSJ
Monitor cable	Transfers video signal to RGB monitor	2 m, 5 m	N/A	FZ-VM_M
Parallel cable	Flying leads	2 m, 5 m	N/A	FZ-VP_M
	Connector type	2 m, 5 m	Use with terminal block units OMRON XW2B-50G4, XW2B-50G5, XE2D-50G6	FZ-VPX_M

## Strobe controllers

Application	Channels	Source	Model
Required to control external lighting from FZ4 controller	1	For FL-Series lights	FL-TCC1
	1	For CCS Inc. lights	CCS-SCU-1024
	1	For Moritex Corp. lights	3Z4S-LT MLEK-C100E1TS2

## Controller peripheral devices

Type	Description	Model
LCD monitor	For box-type controllers	FZ-M08
USB memory	1 GB capacity to store images and data	FZ-MEM1G
VESA attachment	For installing the LCD integrated-type controller	FZ-VESA
Desktop controller stand	For installing the LCD integrated-type controller	FZ-DS

## Flexible Vision System to Meet Machine and Customer Needs

Vision system that allows complete customization of screens, processing items and measurement calculations.

- Ready to use image processing parts
- Ready to use program samples to quickly build vision system
- Capacity for up to 8 customizable screen layouts
- Import programs of screens and processing items
- Develop macros for measurement calculations



## System Configuration

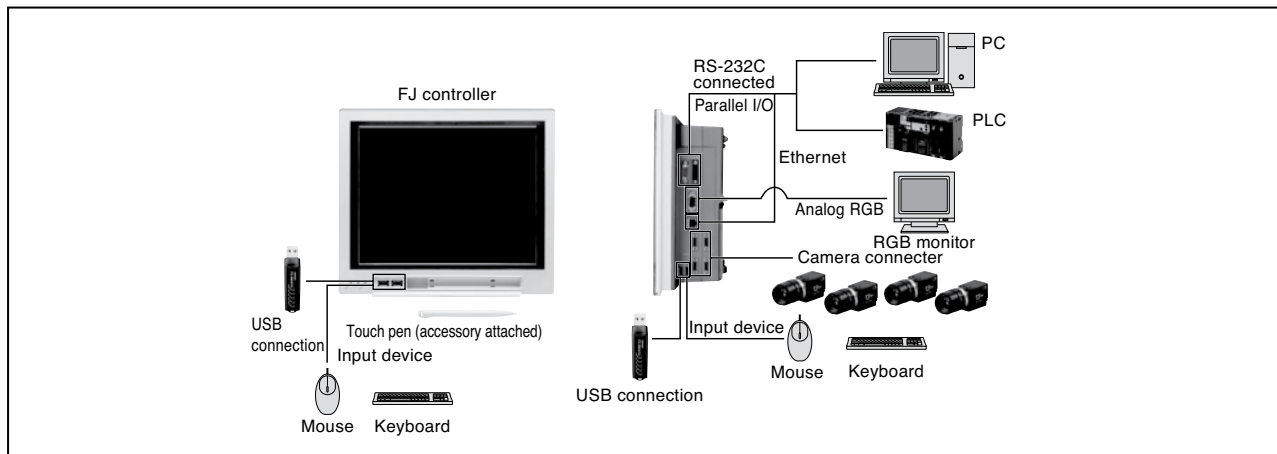

### Controllers integrated with LCD

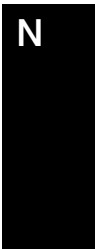
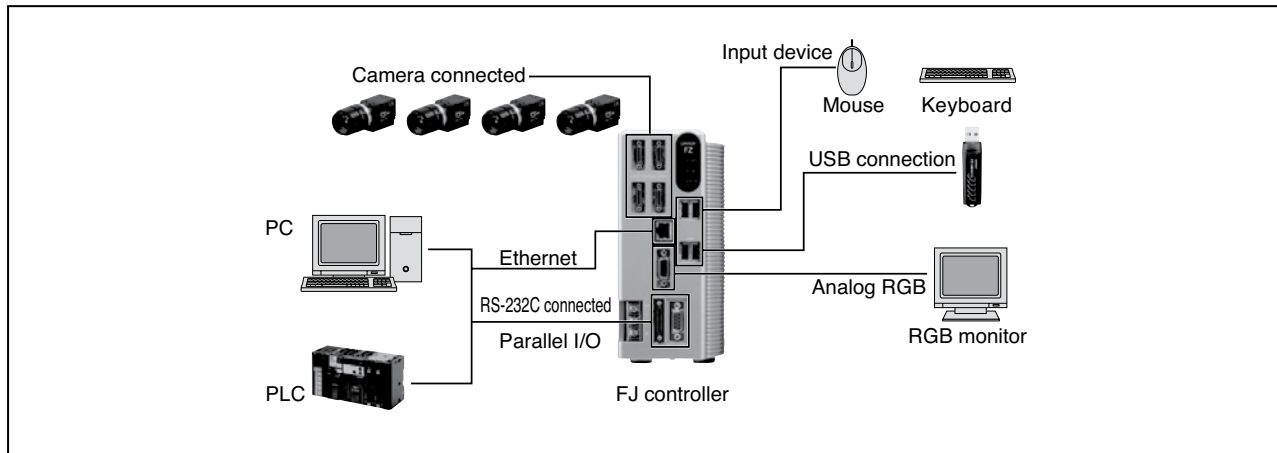

### Box-type Controllers



## Controllers

CPU	Type	Dual-task	HALCON installed (See note)	No. of Cameras	Output	Model
 <p>Controller integrated with LCD    Box-type Controller</p>	Controller integrated with LCD	Yes	No	2	NPN	FJ-3000
		Yes	No	4	NPN	FJ-3000-10
		Yes	No	2	PNP	FJ-3005
		Yes	No	4	PNP	FJ-3005-10
		Yes	Yes	2	NPN	FJ-H3000
		Yes	Yes	4	NPN	FJ-H3000-10
		Yes	Yes	2	PNP	FJ-H3005
		Yes	Yes	4	PNP	FJ-H3005-10
	Box-type Controller	Yes	No	2	NPN	FJ-3050
		Yes	No	4	NPN	FJ-3050-10
		Yes	No	2	PNP	FJ-3055
		Yes	No	4	PNP	FJ-3055-10
		Yes	Yes	2	NPN	FJ-H3050
		Yes	Yes	4	NPN	FJ-H3050-10
Yes		Yes	2	PNP	FJ-H3055	
Yes		Yes	4	PNP	FJ-H3055-10	
	Box-type Controller	No	No	2	NPN	FJ-350
		No	No	4	NPN	FJ-350-10
		No	No	2	PNP	FJ-355
		No	No	4	PNP	FJ-355-10

Note: HALCON runtime license has been installed. The development of HALCON requires HDevelop.  
For cameras, lenses and cable selection refer to FZ4 section.

## Development Environment

Type	System requirements	Model
Application Producer 	<ul style="list-style-type: none"> <li>• CPU: Intel Pentium Processor (SSE2 or higher)</li> <li>• OS: Windows XP professional (32-bit) Service pack 3 or later, or Windows 7 Professional (32-bit) or Enterprise (32-bit) or Ultimate (32-bit)</li> <li>• .NET Framework: .NET Framework 3.5 or higher</li> <li>• Memory: At least 2 GB RAM</li> <li>• Available disk space: At least 2 GB</li> <li>• Browser: Microsoft® Internet Explorer 6.0 or later</li> <li>• Display: XGA (1024 x 768), True Color (32-bit) or higher</li> <li>• Optical drive: CD/DVD drive</li> <li>• The following software is required to customize the software: Microsoft® Visual Studio® 2010 Professional</li> </ul>	FJ-AP1

## Vision Tailored for Motion Control Interface

Advanced vision sensing provides coordinates for alignment and pick-and-place applications.

- FZ high speed cameras with 240 fps (frames per second )
- Added Edge Code processing items for shape extraction
- Calibration wizard for easy setup
- EtherCAT or UDP allows motion interface with Omron or other vendors



EtherCAT<sup>®</sup>



## Controllers

Type	Description	Number of cameras	Communication interface	Outputs	Model
Standard controllers	Box-type controllers	2	EtherCAT built-in	NPN	FZM1-350-ECT
				PNP	FZM1-355-ECT

Notes: For cameras, lenses and cable selection refer to FZ4 section.

For additional lenses please refer to FZ-LE/3Z4S-LE models in Lighting and Accessories section.

For EtherCAT cables please refer to Section A, Industrial Ethernet Media.

## Peripheral Devices

Type	Description	Remark	Model
LCD monitor	For box-type controllers	Resolution: XGA 1024 x 768 pixels	FZ-M08
USB memory	Store images and data	Capacity: 1 GB	FZ-MEM1G
Monitor cable	Transfers video signal to RGB monitor	Cable length: 2 m, 5 m	FZ-VM□M
Parallel cable	Flying leads	Cable length: 2 m, 5 m	FZ-VP□M
	Connector type	Cable length: 2 m, 5 m	FZ-VPX□M





### Bar Lighting

Appearance	Light color	Description	Size (mm)	Model
	White LEDs	Wide area model	20 H x 49.8 W x 20 D	FL-BR5020W
		High-brightness model		FL-BR5020W-H
		Wide area model	20 H x 90.6 W x 20 D	FL-BR9120W
		High-brightness model		FL-BR9120W-H
		Wide area model	20 H x 131.4 W x 20 D	FL-BR13120W
		High-brightness model		FL-BR13120W-H

### Direct Ring Lighting

Appearance	Light color	Description	Size (mm)	Model
	White LEDs	Wide area model	20 H x 90 W x 90 D	FL-DR90W
		High-brightness model		FL-DR90W-H

### FL Lighting Controllers

Appearance	Description	Input voltage	Size (mm)	I/O specifications	Model
	One-channel models	24 VDC	98 H x 22.5 W x 64.9 D	NPN	FL-STC10
				PNP	FL-STC15
	Two-channel models			NPN	FL-STC20
				PNP	FL-STC25
	One-channel	—	—	FZ camera interface module	FL-TCC1

### Extension Cable Standard

Cable length	Weight	Model
1 m	Approx. 50 g	FL-XC1
2 m	Approx. 80 g	FL-XC2
3 m	Approx. 120 g	FL-XC3
5 m	Approx. 190 g	FL-XC5
10 m	Approx. 400 g	FL-XC10
25 m	Approx. 1000 g	FL-XC25

### Extension Cable Flexible

Cable length	Weight	Model
1 m	Approx. 60 g	FL-XC1R
2 m	Approx. 100 g	FL-XC2R
3 m	Approx. 150 g	FL-XC3R
5 m	Approx. 240 g	FL-XC5R
10 m	Approx. 600 g	FL-XC10R
25 m	Approx. 1200 g	FL-XC25R

### Parallel Cable

Cable length	Weight	Model
2 m	Approx. 180 g	FL-XCP2



### Diffusion Plates

Description	Dimensions (mm)	Weight	Model
Bar lighting	49.8 W x 18 H x 4 D	Approx. 5 g	FL-BR5020DF
	90.6 W x 18 H x 4 D	Approx. 10 g	FL-BR9120DF
	131.4 W x 18 H x 4 D	Approx. 15 g	FL-BR13120DF

Description	Outer diameter/Inner diameter/Thickness (mm)	Model
Direct ring lighting	90 OD/50 ID/4 t	FL-DR90DF

### Polarization Plate

Description	Outer diameter/Inner diameter/Thickness (mm)	Model
Direct ring lighting	90 OD/50 ID x 2 t	FL-DR90PL



### CCTV lenses





Model	3Z4S-LE ML-0614	3Z4S-LE ML-0813	3Z4S-LE ML-1214	3Z4S-LE ML-1614	3Z4S-LE ML-2514	3Z4S-LE ML-3519	3Z4S-LE ML-5018	3Z4S-LE ML-7527	3Z4S-LE ML-10035
Appearance	 30 dia. 30	 30 dia. 34.5	 30 dia. 34.5	 30 dia. 24.5	 30 dia. 24.5	 30 dia. 29	 32 dia. 37	 32 dia. 42.5	 32 dia. 43.9
Focal length	6mm	8mm	12mm	16mm	25mm	35mm	50mm	75mm	100mm
Brightness	F1.4	F1.3	F1.4	F1.4	F1.4	F1.9	F1.8	F2.7	F3.5
Filter size	M27 P0.5	M25.5 P0.5	M27 P0.5	M27 P0.5	M27 P0.5	M27 P0.5	M30.5 P0.5	M30.5 P0.5	M30.5 P0.5

### High-resolution, low-distortion lenses

Model	FZ-LEH5	FZ-LEH8	FZ-LEH12	FZ-LEH16	FZ-LEH25	FZ-LEH35	FZ-LEH50	FZ-LEH75	FZ-LEH100
Appearance	 42 dia. 38.7	 34 dia. 41.6	 34 dia. 37.0	 33 dia. 36.5	 33 dia. 39.5	 34 dia. 36.5	 34 dia. 55.0	 36 dia. 51.0	 42 dia. 70.0
Focal length	5mm	8mm	12.5mm	16mm	25mm	35mm	50mm	75mm	100mm
Brightness	F2.8	F1.4	F1.4	F1.4	F1.4	F2	F2.8	F2.5	F2.8
Filter size	M40.5 P0.5	M27.0 P0.5	M27.0 P0.5	M27.0 P0.5	M27.0 P0.5	M27.0 P0.5	M27.0 P0.5	M34.0 P0.5	M40.5 P0.5

The 5-mm Extension Tubes (3Z4S-LE ML-EXR) cannot be used with FZ-LEH25 Lenses.

### Lenses for small cameras

Model	FZ-LES3	FZ-LES6	FZ-LES16	FZ-LES30
Appearance	 12 dia. 16.4	 12 dia. 19.7	 12 dia. 23.1	 12 dia. 25.5
Focal length	3mm	6mm	16mm	30mm
Brightness	F2.0	F2.0	F3.4	F3.4

### Extension tubes

Applicable cameras	Sizes	Outer Diam.	Model
Standard Cameras	Set of 7: 40, 20, 10, 5, 2, 1, 0.5 mm	30 mm max.	3Z4S-LE ML-EXR
Small Cameras	Set of 3: 15, 10, 5 mm	12 mm max.	FZ-LESR

# Lighting & Accessories

## Lenses Optical Chart

### 300,000-pixel High-speed camera FZ-SH□, and Digital camera FZ-S□

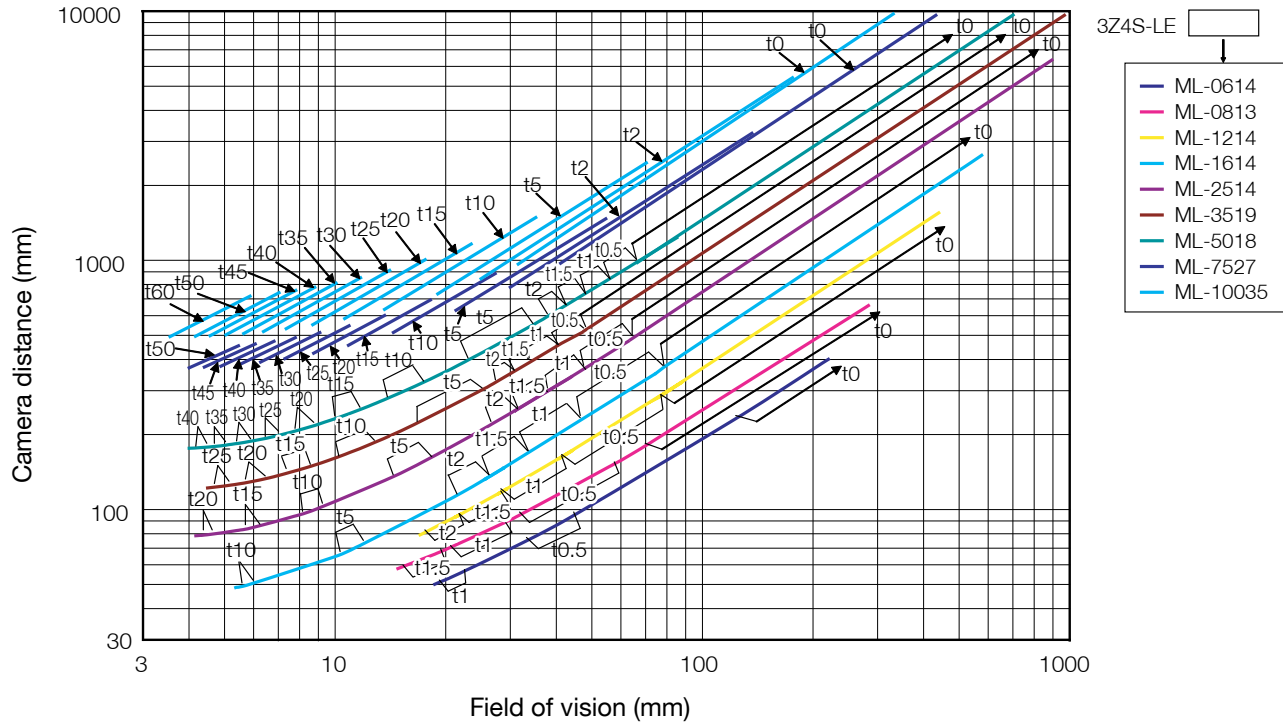

### 2 million-pixel digital camera FZ-S□2M

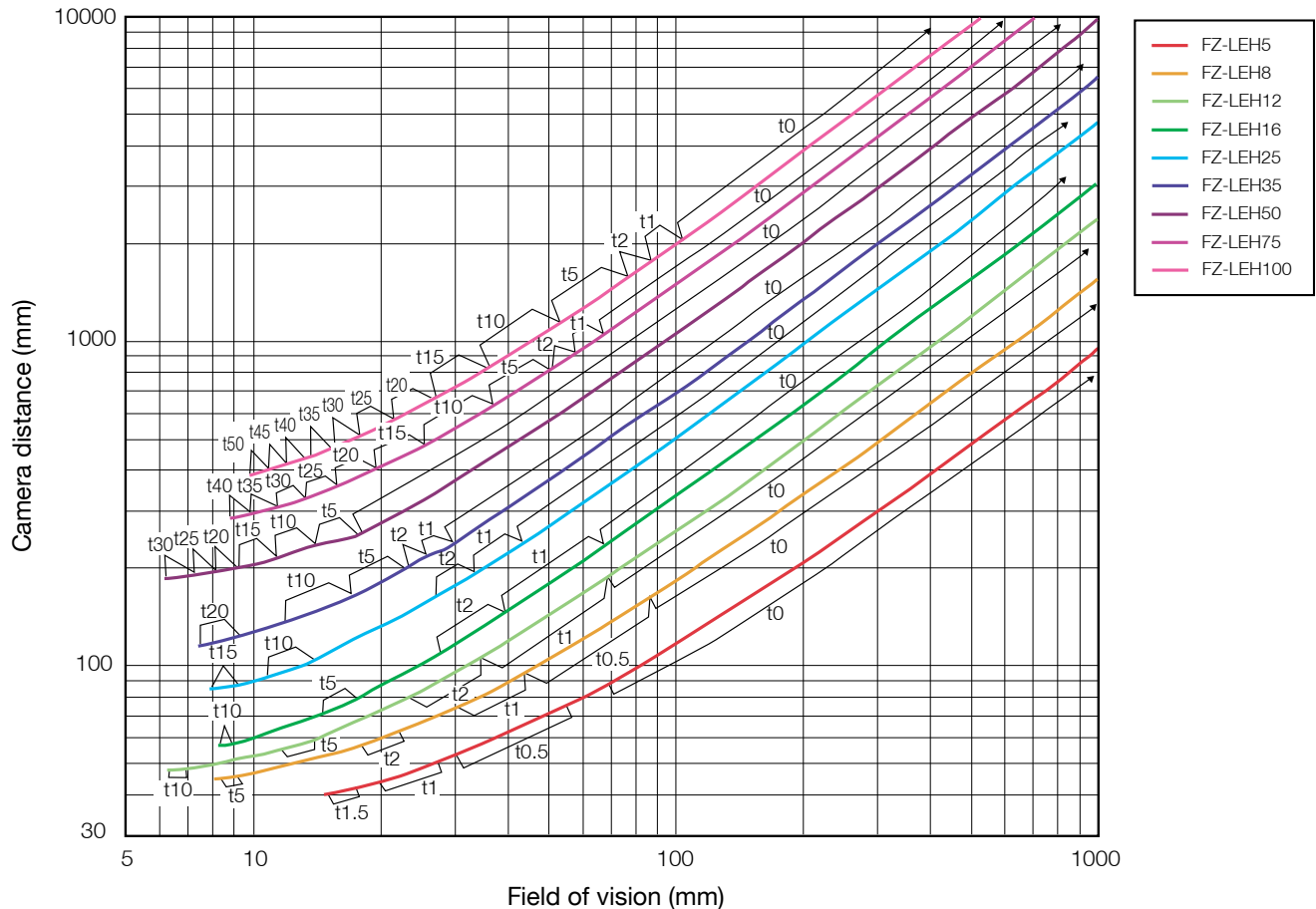

The 5-mm Extension Tubes (3Z4S-LE ML-EXR) cannot be used with FZ-LEH25 Lenses.



## Contents

<b>Selection Guide</b>		O-ii
<b>Linear Code Readers</b>		
<b>MS-3</b>	Ultra-Compact Laser Reader	O-1
<b>QX830</b>	Compact Industrial Laser Scanner	O-1
<b>QX870</b>	Industrial Raster Laser Scanner	O-2
<b>MS Quadrus™ Family</b>	Industrial Ultra-Compact, 2D Code Reading Imagers	O-3
<b>Imager Auto ID</b>	HS/MobileHawk Code Readers	O-4
<b>TCS1400 Series</b>	Hand-held CCD Bar Code Readers	O-5
<b>TCS1490</b>	Long Range Bar Code Reader	O-5
<b>2-Dimensional Code Readers</b>		
<b>V400-H</b>	Hand-held reader for direct-stamped 2D codes	O-6
<b>V400-F</b>	Stable and accurate reader for direct-stamped 2D codes	O-7
<b>V400-R</b>	Ultra-small multi code reader, both 2D & 1D code compatible paper/label	O-8

<b>Industrial RFID Systems</b>		
<b>V680 Series</b>	HF - 13.56 MHz Next-Generation RFID Systems with ISO/ IEC 18000-3 (ISO/IEC 15693) Compliance	O-9
<b>V680-HAM42-DRT</b>	HF - 13.56 MHz V680-Series DeviceNet-Compatible Slaves for RFID Systems. Read and Write up to 58 Bytes	O-10
<b>V680-HAM91/HAM81</b>	HF - 13.56 MHz RFID System can be used just like a sensor	O-10
<b>V640</b>	LF- 134 kHz Systems reads TIRIS tags more reliably than OEM parts	O-11
<b>V750</b>	UHF - 902.75 - 927.75 MHz EPC Class I Gen 2 Interrogator	O-12

## AUTO IDENTIFICATION SYSTEMS

Omron offers a wide range of reliable identification systems to help you track, trace and verify product moving through your factory, and between warehouse and retail locations. We offer 1D barcode readers, 2D code readers and radio frequency identification (RFID) systems to meet your specific needs. With over 25 years of experience applying radio frequency identification systems, Omron offers unique skills in integrating them for a complete industrial automation solution.

**RFID systems:** UHF for long distance and asset tracking (V750); HF for industrial work-in-progress and tool or part identification (V680); LF for tracking in semiconductor manufacturing settings (V640).



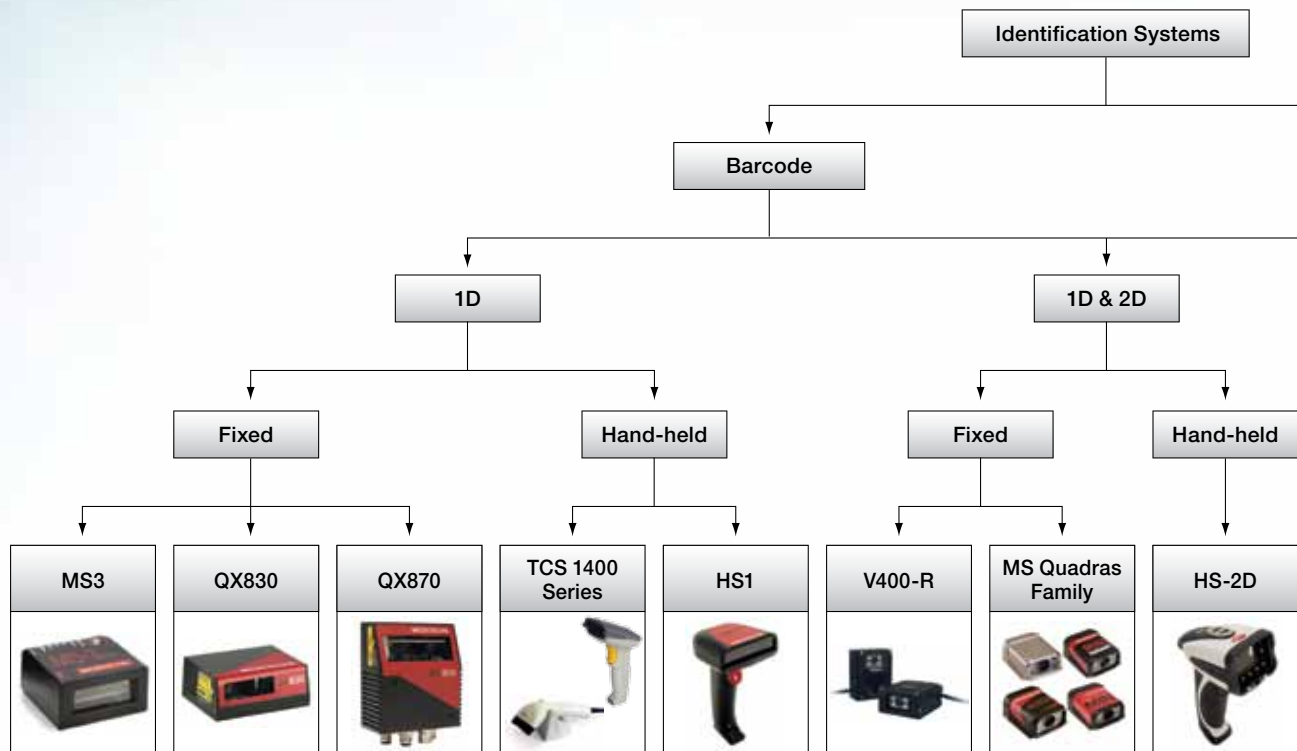

**2D code readers:** CMOS and video imaging models accurately read printed, embossed and engraved codes with great stability. Choose fixed mounting and held-held models.

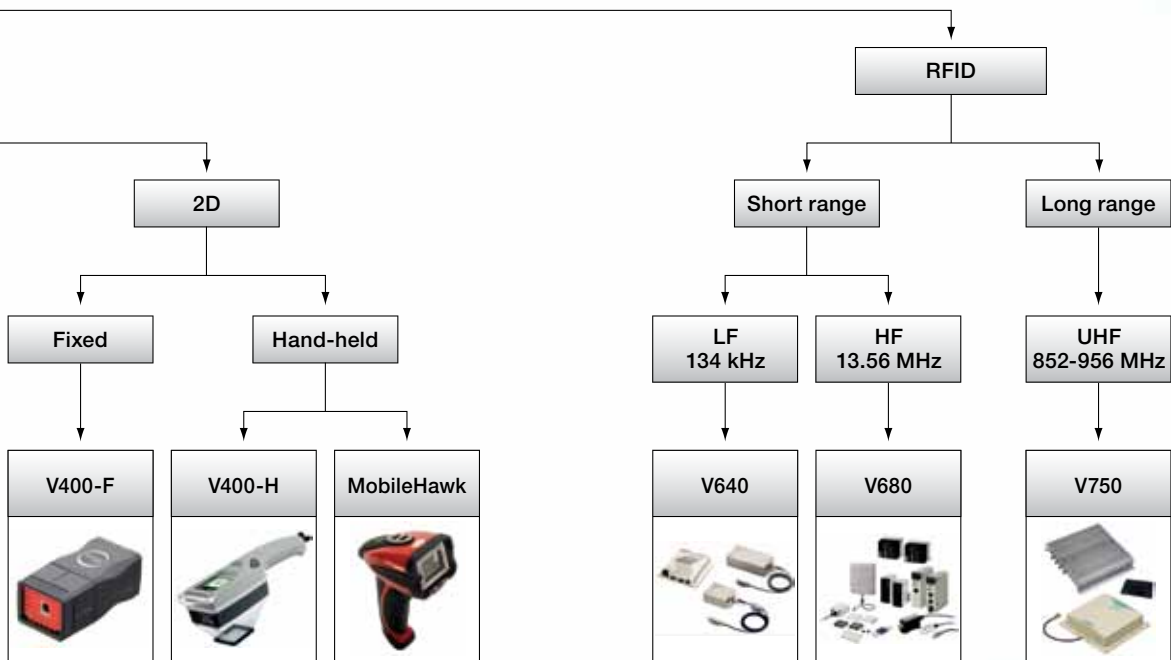
**1D barcode readers:** Laser and CCD imaging versions read most popular code types at high speed. Choose fixed mounting and hand-held models.









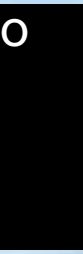

# Selection Table

Category		Identification Systems				
						
Model		V400-F	V400-R	V400-H	MS-3	QX830
Type		Imager	Imager	Imager	Laser	Laser
Read ranges		●	●	●	●	●
Resolution		512 x 484	1280 x 1024	–	Model Specific	Model Specific
IP rating		IP67	IP54	IP64	IP54	IP65
Supply voltage		24 VDC	5 VDC	5 VDC	5 VDC	10-28 VDC
Codes	1D	–	JAN/EAN/ UPC (A,E) Code 39, NW-7, ITF Industrial 2 of 5, Code 93, Code 128 (including EAN128)	–	All Standard	All Standard
	Stacked	–	PDF417 RSS	–	–	MicroPDF PDF417 GS1 Databar
	2D	<ul style="list-style-type: none"> <li>• Data Matrix: CC200, 10 x 10 to 64 x 64, 8 x 18 to 16 x 48</li> <li>• QR Code: (Models 1, 2) 21 x 21 to 57 x 57 (Versions 1 to 10)</li> </ul>	<ul style="list-style-type: none"> <li>• RSS</li> <li>• Data Matrix: ECC200</li> <li>• QR Code</li> <li>• Micro QR Code</li> </ul>	<ul style="list-style-type: none"> <li>• Data Matrix: ECC200, 10 x 10 to 64 x 64, 8 x 18 to 16 x 48</li> <li>• QR Code (Models 1, 2): 21 x 21 to 57 x 57 (Versions 1 to 10)</li> </ul>	–	–
PC software		Optional	Optional	Optional	ESP	ESP
Communications interfaces	RS-232	■	■	■	■	■
	RS-422/RS-485	–	–	–	■	■
	Ethernet	–	–	–	–	■
	DeviceNet	–	–	–	□	□
	USB	–	–	–	–	–
	Bluetooth	–	–	–	–	–

● See data sheet for individual model specifications    ■ Standard    □ Available    – No/not available

# Identification Systems





Category		Identification Systems				
						
Model		<b>QX870</b>	<b>Quadras Family</b>	<b>Imager Auto ID hand-helds</b>	<b>TCS 1400</b>	<b>TCS 1490</b>
Type		Laser	Imager	Imager	Imager	Imager
Read ranges		●	●	●	●	●
Resolution		Model Specific	Model Specific	Model Specific: 2048 pixel imager 1280 x 1024 CMOS	2160 CCD - one line	3648 CCD - one line
IP rating		IP65	IP54	●	IP54	IP54
Supply voltage		10-28 VDC	5 VDC	5 VDC	5 VDC	5 VDC
Codes	1D	All Standard	All Standard Model Specific: Postal Codes	All Standard Model Specific: Postal Codes	UPC/EAN w/ 2 - 5 add. Code39, I 2 of 5, Code 93, Code 128, Codeabar MSI/PLESSY	UPC/EAN w/ 2 - 5 add. Code39, I 2 of 5, Code 93, Code 128, Codeabar, MSI/PLESSY
	Stacked	MicroPDF PDF417 GS1 Databar	MicroPDF PDF417 GS1 Databar	PDF417 GS1 Databar Model Specific: MicroPDF	–	–
	2D	–	Model Specific: • Data Matrix • QR Code • Micro QR Code • Aztec	Model Specific: • Data Matrix • QR Code • Micro QR Code • Aztec • Maxicode	–	–
PC software		ESP	ESP	ESP	–	–
Communications interfaces	RS-232	■	■	□	■	■
	RS-422/RS-485	■	RS-422	–	–	–
	Ethernet	■	–	–	–	–
	DeviceNet	□	□	–	–	–
	USB	–	□	■	■	□
	Bluetooth	–	–	–	–	□

● See data sheet for individual model specifications    ■ Standard    □ Available    – No/not available



## Selection Table

Radio Frequency Identification Systems (RFID)			
			
Model	V640	V680	V750
Detection range	Short distance	Short distance	Long distance
Operating frequency	LF 134 kHz	HF 13.56 MHz	UHF 852-956 MHz
Regional broadcast approvals	US and Europe: FCC Part 15 Subpart C; FCC ID: E4E6CYCIDV6400304; EC/R&TTE Directive  Conforms to carrier reader/writer-related SEMI standards; SEMI E99, E4, and E5	US, Canada, Mexico, Latin America, Europe, Singapore, Malaysia, the Philippines, Japan, China, Hong Kong, Taiwan, Korea  Conforms to ISO/IEC 18000-3 (ISO/IEC 15693); FCC Standards and R&TTE Directive	US, Canada, Europe, Japan, China
Interface ports	V3 - RS-232C interface, ETN - Ethernet interface (compatible with SECS I/II protocol)	RS-232C, RS-422, RS-485, DeviceNet	Ethernet, RS-232C
Host devices	PC	PC, Omron CJ/CS series PLC, 3rd-party PLC, DeviceNet	PC
Controllers	Standalone	Standalone, PLC-mount	Standalone
Antennas supported	1	1 or 2	Up to 4 Mono Static antennas (transmit/receive integrated)
Read/write antennas	Rectangular (50 x 30 x 12 mm including mounting plate)	Cylindrical, compact with separate amplifier, rectangular with built-in amplifier models available - see literature for details	Rectangular (221 x 221 x 70 mm)
Data carriers (tags)	RI-TRP series tags	1 kbyte EEPROM; 2, 8 or 32 kbyte FRAM	EPCglobal Class 1 Generation 2 (ISO18000-6 Type C)

# MS-3 Linear Code Reader

Quick Link  
D723

## Ultra-Compact Laser Reader

- Decodes/second: Up to 1000
- Read range: 2 to 10" (51 to 254 mm)
- Wide scan angle
- IP54 Enclosure



At 1,000 decodes per second, the MS-3 Laser offers the fastest read performance in the class of embedded compact bar code scanners. The wide scan angle of 70 degrees coupled with ultra-compact size and flexible mounting make the MS-3 Laser the optimal choice for high-speed reading in OEM instruments. High performance and flexibility are designed into virtually every aspect of the MS-3 Laser. Optics are factory-adjustable and our feature-rich firmware can be customized to satisfy almost any application. The MS-3 is well-suited for any embedded bar code application where size, performance, and budget savings are core factors.



## Application Examples

- Clinical instruments
- Bank ATMs
- Parking kiosks
- Point-of-sale terminals
- Robotics

## Symbologies Supported

- Code 93
- Code 39
- Code 128
- Codabar
- Pharmacode
- Interleaved 2 of 5
- UPC/EAN
- PDF417 (option)

# QX830 Linear Barcode Reader

Quick Link  
D728

## Compact Industrial Laser Scanner

The QX830 combines flexible connectivity with high-performance decoding capabilities to reliably read 1D barcodes in almost any automation environment. In addition to the Quick Connect System and X-Mode Technology, the QX830 features an EZ button for quick reader setup and configuration, with no computer required.



- Decodes/second: 300 to 1400
- Read Range: 1 to 30" (25 to 762 mm)
- Optional Embedded Ethernet TCP/IP & EtherNet/IP
- X-Mode Technology: Decodes damaged, poorly printed, or misaligned codes
- IP65 Enclosure



## Symbologies

### Linear



### Stacked



MicroPDF PDF417GS1

Databar

## Industrial Raster Laser Scanner

The QX870 makes reading bar codes and stacked 2D codes easy. Push-button calibration and a fully programmable feature set enable you to quickly and easily configure the scanner to meet your needs. Raster settings are programmable to read multiple symbols at different locations or at varying distances.

- Decodes/second: 300 to 1400
- Read Range: 1 to 30" (25 to 762 mm)
- Optional Embedded Ethernet TCP/IP & EtherNet/IP
- X-Mode Technology: Decodes damaged, poorly printed, or misaligned codes
- IP65 Enclosure



## Symbologies

### Linear



All Standard

### Stacked



MicroPDF



PDF417



GS1 Databar

### Industrial Ultra-compact, Auto-focus Mega Pixel Imager

- Decodes/second: up to 10
- Read range: 1 to 10" (25 to 254 mm)
- 1.3 megapixel processing
- Patented Quadrus technology
- Auto-focus
- Wide-scan angle
- IP65 Enclosure



It is the ideal imager for automation engineers who need flexibility to read any code, at any distance, at any speed. Quadrus MINI reads both linear bar codes and 2D codes in any orientation, while in motion. EZ button setup, symbol locator, and visible performance indicators provide ease of use while large area reading and small form factor allow for positioning flexibility.



**Auto-focus:** Position your symbol at the center of the field of view and push the EZ button for a true auto focus experience. Quadrus MINI automatically adjusts for distance to focus on the symbol and sets internal parameters to optimize reading of symbol.

**Mega Pixel Processing:** Mega Pixel processing allows for reading multiple small, high-density codes or long 1D codes. Quadrus MINI can read down to 3.3 mil high-density codes and can decode up to 100 symbols within the field of view in a single read capture. Three optical versions are available.

**Dynamic, Omni-Directional Reading:** The Quadrus MINI decodes linear bar codes or 2D codes omni-directionally in moving applications, at speeds up to 100 feet per minute (0.5 meters/second).

**Push-Button Set-up:** The EZ button is a powerful set-up feature. Three programmable positions can be used to perform tasks including: Read Rate, Auto-focus/Calibration, Save for Power-on, Load New Master, and Sleep Mode.

### Symbologies

#### Linear Bar Codes:

- Code 39
- Code 128
- BC 412
- I2 of 5
- Pharmacode
- UPC/EAN
- Codabar
- Code 93

#### 2D Symbologies:

- Data Matrix (ECC 0-200)
- QR Code

#### Stacked Symbologies:

- PDF417
- Micro PDF417
- RSS (Composite & Stacked)

# Imager Auto ID HS/MobileHawk Code Readers



## Hand-held Automatic 1D and 2D Imagers

Hand-held imagers have fast and accurate performance and are built to withstand industrial environments.

- HS-2D and MobileHawk read linear and 2D codes; HS1 reads linear and stacked codes
- HS1 and HS-2D are available in USB or RS-232 interface options
- ESP® Easy Set-up Program provides single-point configuration
- Easy-to-use Point and Click targeting, HS-2D and MobileHawk have audible/vibrating indicators
- MobileHawk with X-Mode Technology decodes damaged, poorly printed, or misaligned codes



## Symbologies - Model specific

### Linear



All Standard



Postal Codes

### Stacked



MicroPDF



PDF417



GS1 Databar

### 2D



Data Matrix



QR



Micro QR



Aztec

# TCS1400 Series

## Linear Code Reader

Quick Link  
D726

### Hand-held CCD Bar Code Readers

**High-move Tolerance:** Accurately reads bar codes on moving work pieces

**Ergonomic Design:** The scanner's ergonomic design makes it easy to hold and use, even for small hands. The angled shape allows for wrist neutral scanning, reducing the risk of repetitive motion injuries

**Reads All Standard Bar Codes:**

The scanner automatically reads and discriminates UPC/EAN, Codabar, Code 39, Code 93, Code 128, and Interleaved 2 of 5. It can also read UPC/EAN with 2 or 5 digit addendum

**Rugged Construction:** The Engineering grade molded housing is designed to take years of wear and tear. The recessed window is protected from fingerprints and dirt



**Reads Poor Quality Symbols:**

The advanced circuitry and optics of the scanners allow them to read dirty and low contrast bar code symbols

**Maintenance-Free Over a Long Life:**

The solid state design has no moving parts, for reliable operation without maintenance or adjustments

**Single Voltage Operation:** 5-volt power supply for compatibility with standard interface voltages

# TCS1490

## Linear Barcode Reader

Quick Link  
D727

### Long-Range Bar Code Reader

**Distance Reading:** Read from nearly touching to 11 inches, depending on symbol characteristics Read Range: 1 to 30" (25 to 762 mm)

**Video/CCD Imager:** There are no moving parts to wear out, break, or need adjustment

**Quick Change Cable:** Modular design allows for quick and easy cable changes (e.g., from RS-232 to keyboard wedge); this allows one bar code reader to be used in multiple environments

Omron PLC RS-232C direct connect model

**Rugged Construction:** Built to withstand industrial and commercial environments: Engineering grade polymers, rugged



construction and strategically placed bumpers make this reader ideal for demanding applications

**Holder and Stand Options:** Provide for hands-free scanning

# V400-H

## Two-Dimensional Code Reader



### Hand-Held 2-Dimensional Code Reader with Built-In Monitor

- Read directly marked 2-dimensional codes on metal parts, printed circuit boards, and electronic components
- Display reading results in four patterns to match your application
- Easy-to-press trigger buttons and light weight 230 g (approx. 8 oz) reduce operator fatigue
- Change settings without connecting to a PC
- Equipped with both coaxial illumination and oblique illumination, reader automatically switches to match the object being read, accounting for different reflection factors
- Built-in LCD monitor confirms the position of the 2D code then displays the reading results and image



- Simplify positioning with optional detachable aiming guide
- Read data can be time-stamped then stored on a commercially available SD memory card
- Connect to a 5 VDC power supply or use optional AC adapter

## Ordering Information

### Hand-Held Reader

Item	Description	Model
Hand-held 2D code reader	3 x 3 mm field of vision; RS-232C serial interface	V400-SH111-1 (See note 1)
	5 x 5 to 10 x 10 mm field of vision; RS-232C serial interface	V400-H111
	15 x 15 to 30 x 30 mm field of vision; RS-232C serial interface	V400-H211
Contact for positioning	Detachable aiming guide simplifies accurate positioning for high-efficiency operation	V400-AC2
Power supply	Provides 5 VDC from AC line power	S8VS-01505
AC adapter	Provides 5 VDC directly from supply 115 VAC outlet	V600-AC22

Note: 1. V400-SH111-1 sold as an assembled kit, consisting of; Micro code reader V400-H111-1, contactor, and communication cable.  
Power converter is required, but not included.

### Cables

Item	Description	Length	Model
Communications cable	For Omron PLC connection, with power cord	2 m	V400-W20-2M
		5 m	V400-W20-5M
	For PC-compatible connection, with power cord	2 m	V400-W21-2M
		5 m	V400-W21-5M
	For PC-compatible connection when using AC adapter	2 m	V400-W22-2M
		5 m	V400-W22-5M

## Fixed Mount 2D Code Reader

**Simple Selection with a One-Piece Design:** Integrated lens and lighting eliminate having to find the right combination to match each work piece.

**Easy, One-Step Teaching Sets Initial Reading Parameters Instantly:** Commands for adjustments also can be made using external devices.

**Change the Process without Stopping the Line:** Store up to 5 sets of reading conditions in banks for fast production change over.

**Stable, Accurate Reading for any Work-piece:** We have achieved high accuracy for directly marked codes by combining the industry's most advanced reading algorithm with lighting control, that is optimized for data reading. Even directly marked 2D codes printed onto materials with varying reflectivity, such as metals, printed wiring boards, and glass can be read with excellent accuracy.

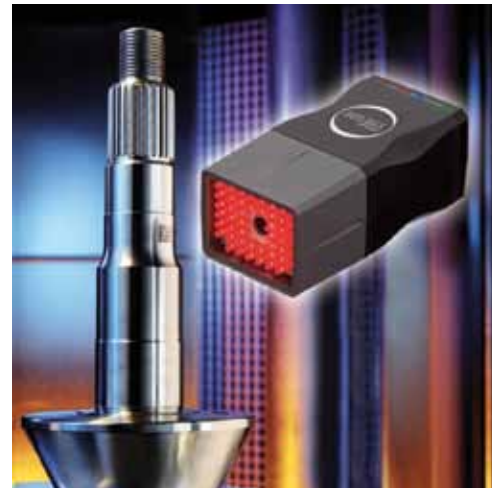

## Ordering Information

Item	Description	Field of view	Working distance	Cell size	Code size (Note 1.)	Model
2D Code readers	Narrow field of vision	14 x 18 mm	100 mm	0.2 to 0.3 mm	2 to 9 mm	V400-F250
	Wide field of vision	31 x 42 mm	200 mm	0.4 to 0.7 mm	4 to 21 mm	V400-F350
	C-mount	Can be varied using a C-mount lens. External 2-channel lighting. (See note 2)				V400-F050

Note: 1. These are intended to be reference values for use in model selection.  
2. For use only with Moritex MG-Wave Series lighting.

## Cables

Insert cable length in empty box in model number.

Item	Description	Output	Length	Model
Communications cable	For connection to SYSMAC Series PLC (includes power line)	NPN	3, 5, 10, or 15 m	V400-W23□
		PNP		V400-W23P□
	For connection to an IBM PC/AT or compatible (includes power line)	NPN		V400-W24□
		PNP		V400-W24P□
Monitor cable	NTSC signal level, video output	-	1 or 5 m	V400-WMO□

□ = Cable length

## Monitor

Item	Description	Size	Model
LCD Monitor	Panel mount, liquid crystal color – TFT	143 H x 185 W x 42.2 D mm	F150-M05L



## Ultra-Small Linear and 2D Code Reader

- Multi-code reading that automatically recognizes major paper/label 1D and 2D codes
- 1.3 Mega pixels (SXGA) CMOS image sensor
- Aiming feature (Green LED) to quickly position the scanning area for code recognition
- Front view and side view types available for flexible installation



## Ordering Information

### Multi-Code Imager (Scanner)

Type	Description	Image sensor type	Effective pixels	Cable length, 8-pin DIN connector	Dimensions (H x W x D mm)	Model
Imager	Side view type	CMOS	1280 x 1024	1.5 m	58 x 46 x 24.2	V400-R1CS
	Front view type					V400-R1CF

### Dedicated Cables (Order Separately)

Cable Type	Cable length	Model
SYSMAC D-sub 9-pin cable	0.8 m	V509-W011
IBM PC/AT or compatible D-sub 9-pin cable		V508-W011D

### Accessories (Order Separately)

Description	Description	Model
Power supply	Switching power supply, DIN rail mount 100~240 VAC input, 5 VDC 15 W output	S8VS-01505

## General Specifications

Item	V400-R1CF	V400-R1CS
View direction	Front view	Side view
Applicable codes	2D code: QRCode, DataMatrix (ECC200), MicroQR, PDF417 Bar code: WPC(JAN/EAN/UPC-A/UPC-E), NW-7, ITF, STF (2 of 5 bar), Code39, Code93, Code128, RSS-14, RSS Limited, RSS Expanded	
Resolution	Bar code: 0.1 mm 2D code: 0.169 mm	
Working distance (WD)	Approx. 60 mm	
Field of vision, WD=60 mm	52 x 41 mm	
Lighting	Red LED x 4 (wavelength: 630 nm)	
Aiming guide	Green LED x 2 (wavelength: 527 nm)	
Image sensor	CMOS area sensor	
Effective pixels	1280 x 1024 pixels	
Power supply voltage	4.5 to 5.5 VDC	
Current consumption	Operation: 500 mA Standby: 300 mA	
Serial interface	RS-232C	
OK/NG outputs	NPN open collector output	
Weight	Approx. 120 g (Cables and accessories not included)	
Size	58 x 46 x 24.2 mm	
I/O connector	DIN 8-pin connector	
Cable length	Approx. 1.5 m	

## RFID Systems with ISO/ IEC 18000-3 (ISO/IEC 15693) Compliance

- High-speed, 27 kbps transmission (response-only speed of 53 kbps from the V680-D□KF68)
- Read/write antennas and ID tags with excellent environmental resistance
- Wide line-up of ultra-compact, long-life ID tags, with capacities from 1 to 32 Kbytes
- Seven software modes make it possible to visualize data transmission
- ID Map Manager simplifies memory map



designing for ID tags

- Complies with FCC Standards and R&TTE Directive

## Ordering Information

### ID Controllers

Type	Appearance	Connected ID system	External power supply	PLC unit count	Model
Standalone ID controller RS-232		1 head	DC	-	V680-CA5D01-V2
		2 head		-	V680-CA5D02-V2
CJ-series PLC-based controller		1 head		1	CJ1W-V680C11
		2 head		2	CJ1W-V680C12
CS-series PLC-based controller		1 head		1	CS1W-V680C11
		2 head		2	CS1W-V680C12

### Hand-held Reader/Writer

Type	Appearance	Transmission interface	Power supply	Cable length	Model
Hand-held Wand Interface to PC		USB	5 VDC ±5%	0.8 m	V680-CHUD 0.8M
				1.9 m	V680-CHUD 1.9M
		RS-232C	5 VDC ±5% 0.8 m	2.5 m	V680-CH1D 2.5M
			AC adapter 5 VDC from 115 VAC supply outlet	2 m	V600-A22
Hand-held Wand Interface to Portable PC		RS-232C	5 VDC ±5%	0.8 m	V680-CH1D-PSI
Portable PC for Hand-held Wand		Serial Bluetooth	3.7 V battery pack	-	V680-A-7527S-G3-EG-S

**Accessories** See product literature for antenna and tag listings.

# V680-HAM42-DRT

## Industrial RFID Systems Sensors

Quick Link  
D426

### V680-Series DeviceNet-Compatible Slaves for RFID Systems

- V680-series DeviceNet-compatible slaves for RFID systems
- Includes a built-in amplifier, yet has a compact size of 65 x 65 x 65 mm; compatible with V680-series ID Tags and Antennas
- Read and write 4, 26, or 58 bytes of data
- Includes an Access Mode that is compatible with the V600-HAM42-DRT to enable the use of existing programs
- Complies with international standards, including CE, UL/CSA, and radio wave regulations. (Radio wave regulation compliance is applicable to Japan, Europe, the U.S.A., and Canada. Radio wave regulation compliance for China and South Korea is pending)
- Approval for UL/CSA is pending



# V680-HAM91/-HAM81

## Flag Sensors

Quick Link  
D525

### RFID System can be Used Just Like a Sensor

Easy to set up V680-HAM91/81 ID Flag sensors read and write 16 bits of data with just one unit. Use them in applications from simple product identification to managing work-in-progress.

- Read or write 16 bits of data (for up to 64,000 IDs) with one unit despite its compact size
- Read or write up to 128 bits by using the address shift function
- NPN and PNP output models
- Uses V680-series tags and antennas
- Accesses existing V600-HAM/HAR programs
- Complies with international standards CE, UL/CSA
- Radio wave regulation compliance applies to Japan, Europe, U.S.A., and Canada; compliance is pending for China and South Korea



### Reliable Antenna and Controller Reads TIRIS Tags

- Read/write data embedded in TIRIS tags (Texas Instruments 32-mm Glass Multipage Transponder model RI-TRP-DR2B) at 134 kHz
- V640 antenna and controller offer better repeatability, distance and reliability than OEM parts
- Conforms to carrier reader/writer-related SEMI standards; SEMI E99, E4, and E5
- Antenna dimensions conform to SEMI E15.1
- Noise measurement function for detecting proper placement of antenna
- Shielded antenna reduces influence of surrounding metal
- Sustain productive uptime: Use an ID Link Unit (V700-L11) to keep the CIDRW system turned ON while the amplifier unit is removed/installed due to malfunction or



during maintenance

- Compatible with SECS communications protocol (CIDRW Controller V700-L22)
- Track FOUPs (Front-Opening Unified Pods), reticles, and pods moving through the fabrication
- CE marking/FCC approvals

### Ordering Information

Product	Description	Dimensions (H x W x D)	Model
CIDRW head	2-meter cable	30 x 50 x 12 mm (including mounting plate)	V640-HS61
Amplifier unit	RS-232C interface, RS-485 interface 24 VDC	185 x 80 x 43 mm	V640-HAM11-V3
	Ethernet interface 24 VDC	185 x 80 x 43 mm	V640-HAM11-ETN
CIDRW controller	24 VDC; RS-232C interface (compatible with SECS I/II protocol)	167 x 150 x 28 mm	V700-L22
ID link unit	24 VDC; RS-232C interface; RS-485 interface	65 x 110 x 64 mm	V700-L11
Accessories set	Connector accessories for the V640 Amplifier Unit: Power supply connector (1) Power supply connector Pins (3) RS-485 Port connector (1)		V640-A90
ID tag	PBT resin tag stick tag	3.9 mm dia. x 27 mm	V640-D23P□

### Build a CIDRW System Conforming to SEMI Standards

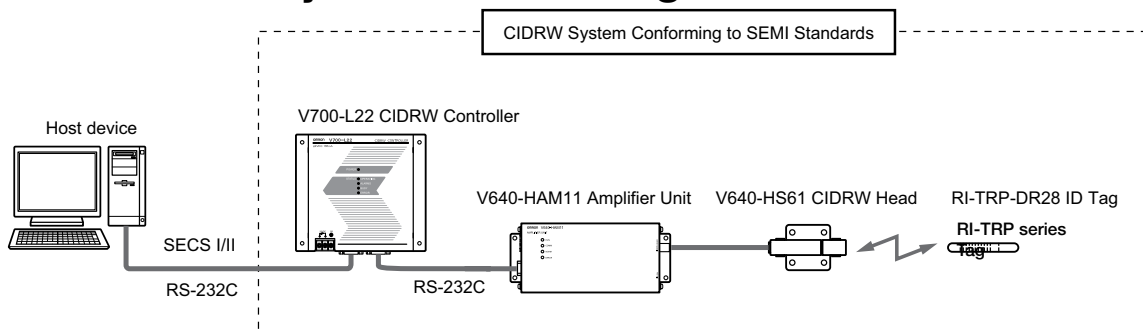

## EPC Gen 2 Interrogator Platform Class 1 for Long-Distance Communication

- Designed to have high read range, quick response and simple operation
- ISO/IEC 18000-6C compliant
- Rich maintenance functions and on-site verification functions
- Self-operation function
- Multiple LED operation displays
- Complies with FCC Standards and R&TTE Directive, UHF 902.75 - 927.75 MHz



## ID Controllers

No. of Connectable Antennas	Transmission Interface	Power Supply	Dimensions H x W x D mm	Model
Four	Ethernet, RS-232C	DC power supply, includes exclusive AC adapter	246 x 215 x 43.5	V750-BA50C04-US

## Read/Write Head (Antenna)

Read/Write Head Type	Data Carrier Compatibility (See Note 1.)	Connection	Dimensions H x W x D mm	Model
Square type, mono-static antenna (circular)	V750-D04P096-R1 or EPCglobal Class 1, Gen 2 inlay	Standard cable, 0.3 m length, waterproof connector	256 x 256 x 57	V740-HS01CA

## Antenna Extension Cable

Description	Cable Length	Model
Antenna extension cable (See Note 2.)	3 m	V740-A01-3.0M
	10 m	V740-A01-10M
	20 m	V740-A01-20M

## Data Carriers (Tags)

Tag Type	Description	Data Capacity	Dimensions H x W x D mm	Model
Battery-less, EPCglobal Class 1, Gen2 (See Note 1.)	Encapsulated Rynite® PET tag	96 bytes	75 x 125 x 9	V750-D04P096-R1

Note: 1. The transmission distance may vary based on packaging and application considerations. Refer to the User's Manual (V750: Cat. No. SRFM-012-A) for details.

2. Use an Antenna Cable to connect the Read/Write Antenna to the Controller. The maximum cable length is 10 m.

## Contents

<b>Selection Guide</b>		P-ii
<b>General Purpose Electromechanical Relays</b>		
<b>G2RV</b>	Ultra-slim industrial 6 A relay for PLC expansion	P-1
<b>G2R□-S</b>	Slim general purpose 10 A plug-in relays	P-2
<b>MY</b>	Multi-pole, long life general purpose relay	P-3
<b>LY</b>	Plug-in general purpose 15 A relay	P-4
<b>MKS</b>	Ultra-thin 10 A general purpose subminiature sensors with built-in amplifiers	P-5
<b>MKS-X</b>	44 mm Tall AC or DC load relays with high maximum switching capacity	P-6
<b>MJN</b>	Rugged power driver with superior arch suppression, up to 30 A	P-7
<b>G7J</b>	Heavy duty 25 A relay for switching motors, compressors and pump controls	P-8
<b>G7L</b>	High capacity relay, 30 A rated load	P-9
<b>MGN</b>	Heavy-duty power relay switches 30 A loads	P-10
<b>G7Z</b>	Multi-pole power relay for contactor current range - 40 A at 440 VAC	P-11

### Solid State Relays

<b>G3MC</b>	Ultra-slim compact 1-2A PCB solid state relay	P-12
<b>G3TB</b>	Color-coded PCB solid state relay with LED indicator	P-13
<b>G3RV</b>	Ultra-slim DIN mount relay socket unit	P-14
<b>G3R</b>	High-isolation solid state relay	P-15
<b>G3NA</b>	1-phase, hockey puck style solid state relay	P-16
<b>G3NE</b>	Compact switching 20 A solid state relay	P-17
<b>G3PE</b>	Voltage suppression 30kV+ solid state relay	P-18
<b>G3PA</b>	1-phase, built-in heat sink solid state relay	P-19
<b>G3PH</b>	High power solid state relay, built-in heat sink, replaceable output	P-20

### Monitoring Relays

<b>K8AB-AS</b>	Ultra-slim 22 mm current monitoring relay	P-21
<b>K8AB-P</b>	Ultra-slim 22 mm phase monitoring relays	P-22
<b>K8AB-V</b>	Ultra-slim 22 mm voltage monitoring relays	P-23

## NON-BENDABLE!

### G2RV-SL500 – Reduce wiring time by using push-in technology and cross bars

With the G2RV-SL500 series, only two steps are required to achieve a reliable connection between wire and terminal. Just remove the isolation and push in the wire. Cross bars make your life even easier, as they can be tailored by breaking pins away to meet your configuration requirements.

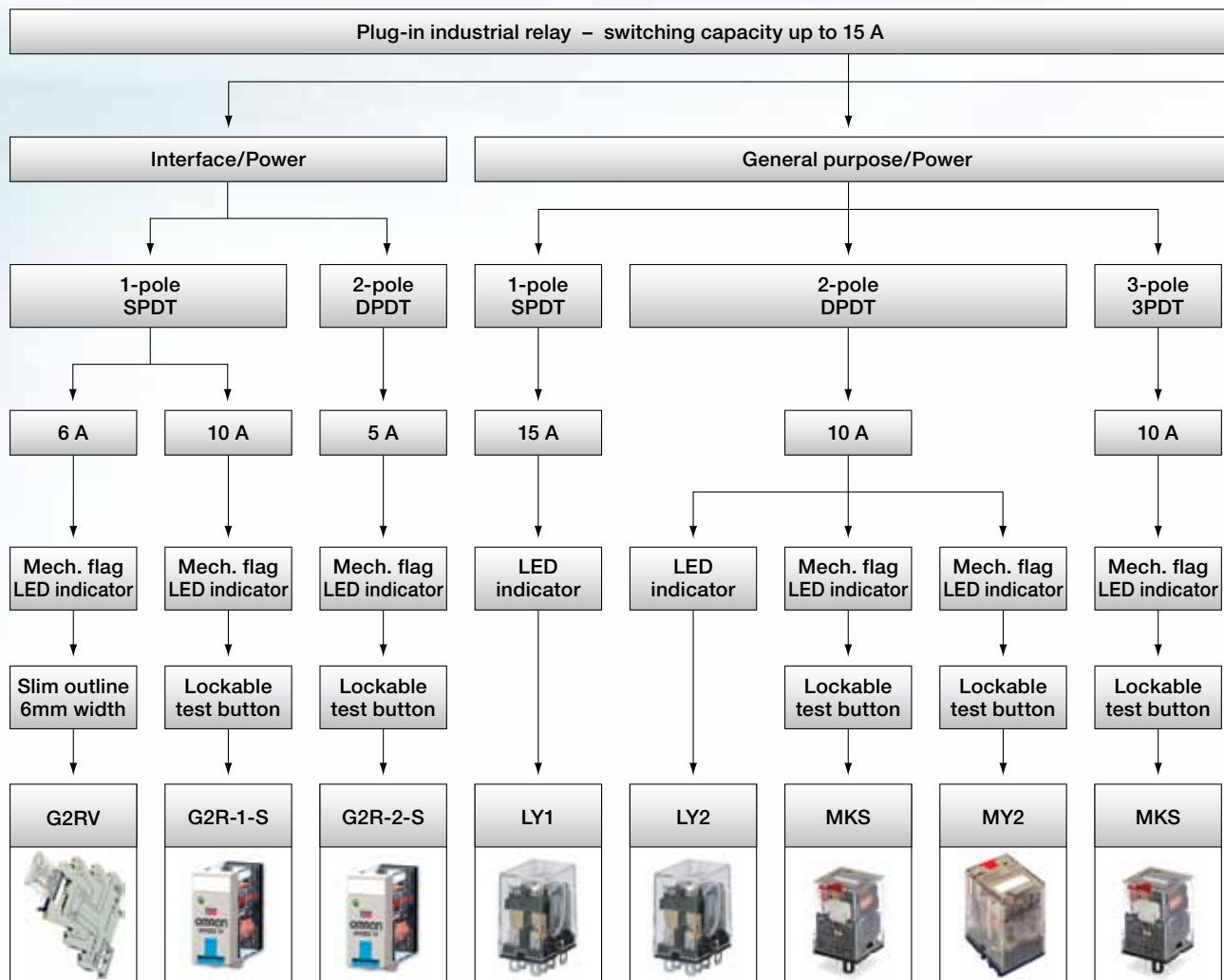

- No tools required
- Fits stranded wires (with ferrules) 0.5 - 2.5 mm<sup>2</sup>
- Fits solid wires 0.5 - 4.0 mm<sup>2</sup>

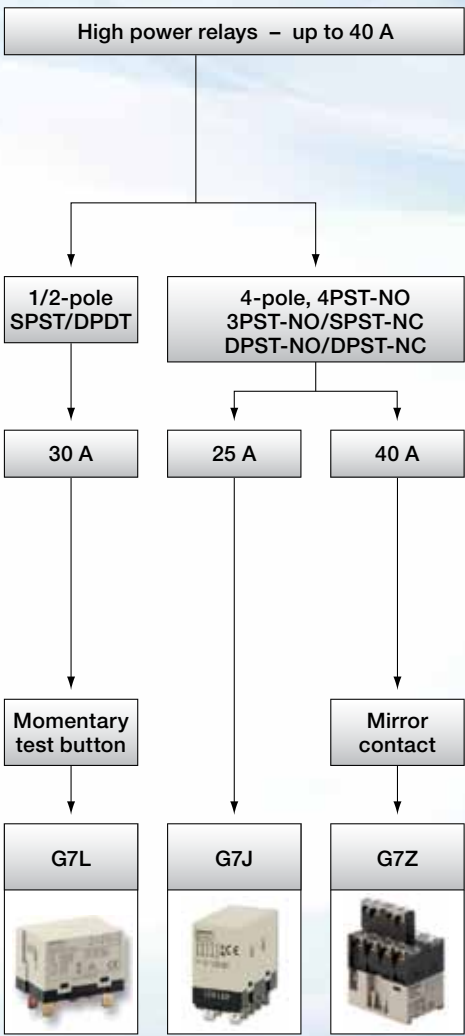
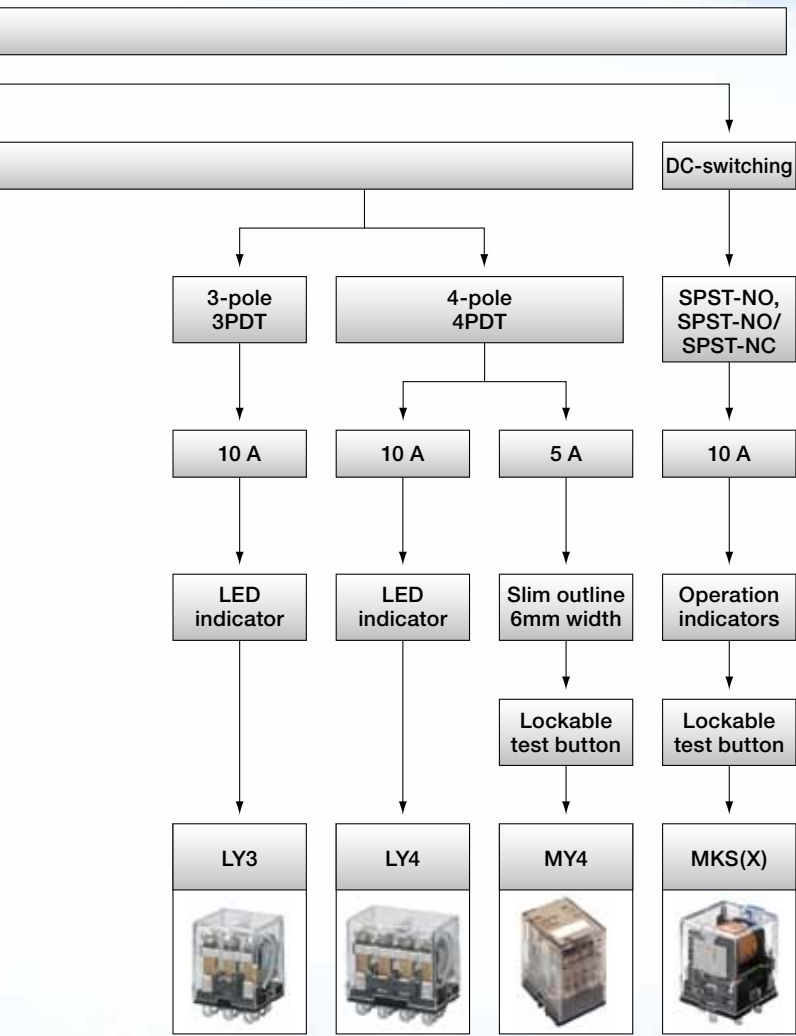
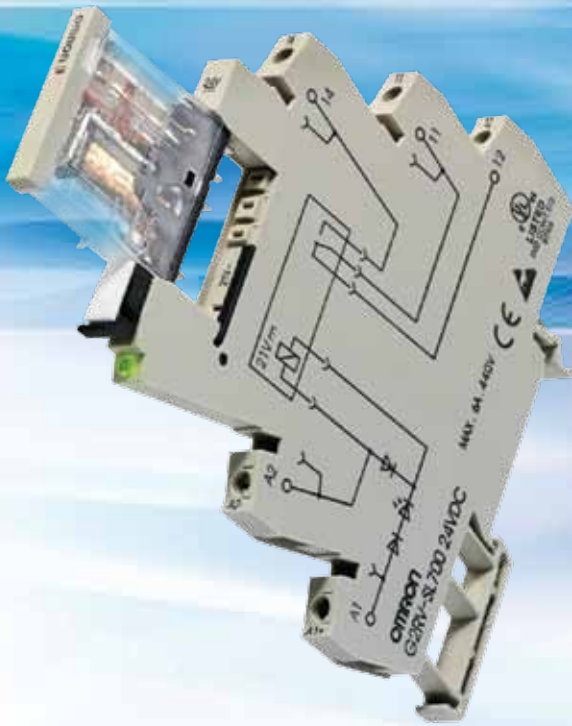







# Selection Table

Category		Interface/Power			General purpose/Power		
							
Selection criteria	Family	<b>G2RV</b>	<b>G2R□-S</b>		<b>MY</b>		
	1-pole	■	■	–	–	–	–
	2-pole	–	–	■	■	–	–
	3-pole	–	–	–	–	–	–
	4-pole	–	–	–	–	■	■
	Contact configuration	SPDT	SPDT	DPDT	DPDT	4PDT	4PDT bifurcated
	Contact material	AgSnIn	AgSnIn	AgSnIn	Ag	AgNi + Au	AgNi + Au
	Max. switching current	6 A	10 A	5 A	10 A	5 A	5 A
	Min. switching current	10 mA at 5 VDC	100 mA at 5 VDC	10 mA at 5 VDC	1 mA at 5 VDC	1 mA at 1 VDC	0.1 mA at 1 VDC
	Gold clad/plate	–	□	□	–	■	■
	Width max. (Relay only)	5.2 mm	13.0 mm	13.0 mm	21.5 mm	21.5 mm	21.5 mm
Features	LED indication	■	□	□	□	□	□
	Mechanical flag	■	■	■	■	■	■
	Momentary test button	–	–	–	–	–	–
	Momentary/Lockable test button	–	□	□	□	□	□
	Label	□	□	□	□	□	□
	Diode (DC coil)	■	□	□	□	□	□
	Varistor (AC coil)	–	–	–	–	–	–
Wiring to socket	CR network (AC coil)	■	–	–	□	□	□
	Screw	□	□	□	□	□	□
	Box clamp	□	–	–	□	□	□
	Screw-less clamp	□	□	□	□	□	



■ Standard    □ Available    – No/not available

# Electromechanical Relays

Category		General purpose/Power									
											
Selection criteria	Family	LY					MKS		MKS(X)		
	1-pole	■	–	–	–	–	–	–	■	–	
	2-pole	–	■	■	–	–	■	–	–	■	
	3-pole	–	–	–	■	–	–	■	–	–	
	4-pole	–	–	–	–	■	–	–	–	–	
	Contact configuration	SPDT	DPDT	DPDT bifurcated	3PDT	4PDT	DPDT	3PDT	SPST-NO	SPST-NO/SPST-NC	
	Contact material	AgSnIn	AgSnIn	AgSnIn	AgSnIn	AgSnIn	AgSnIn	AgSnIn	AgSnIn	AgSnIn	
	Max. switching current	15 A	10 A	7 A	10 A	10 A	10 A	10 A	10 A, 220 VDC; 15 A, 250 VAC	5 A, 220 VDC; 15 A, 250 VAC	
	Min. switching current	100 mA at 5 VDC	100 mA at 5 VDC	10 mA at 5 VDC	100 mA at 5 VDC	100 mA at 5 VDC	10 mA at 1 VDC	10 mA at 1 VDC	10 mA at 24 VDC	10 mA at 24 VDC	
	Gold clad/plate	–	□	■	–	–	–	–	–	–	
Width max. (Relay only)	21.5 mm	21.5 mm	21.5 mm	31.5 mm	41.5 mm	34.5 mm	34.5 mm	34.5 mm	34.5 mm		
Features	LED indication	□	□	□	□	□	□	□	□	□	
	Mechanical flag	–	–	–	–	–	■	■	–	–	
	Momentary test button	–	–	–	–	–	–	–	–	–	
	Momentary/Lockable test button	–	–	–	–	–	□	□	□	□	
	Label	–	–	–	–	–	□	□	–	–	
	Diode (DC coil)	□	□	□	□	□	□	□	Optional for socket	Optional for socket	
	Varistor (AC coil)	–	–	–	–	–	□	□	–	–	
Wiring to socket	CR network (AC coil)	–	□	□	–	–	–	–	–	–	
	Screw	□	□	□	□	□	□	□	□	□	
	Box clamp	–	–	–	–	–	□	□	–	–	
	Screw-less clamp	–	–	–	–	–	–	–	–	–	

■ Standard    □ Available    – No/not available

# Selection Table

Category		High power relays								
										
Selection criteria	Family	G7J			G7L		G7Z			
	1-pole	–	–	–	–	■	–	–	–	–
	2-pole	–	–	–	–	–	■	–	–	–
	3-pole	–	–	–	–	–	–	–	–	–
	4-pole	■	■	■	■	–	–	■	■	■
	Contact configuration	4PST-NO	4PST-NO	3PST-NO/ SPST-NC	DPST-NO/ DPST-NC	SPST-NO	DPST-NO	4PST-NO	3PST-NO/ SPST-NC	DPST-NO/ DPST-NC
	Max. switching current	25 A	25 A	25 A	25 A	30 A	25 A	40 A	40 A	40 A
	Min. permissible load	100 mA at 24 VDC	100 mA at 24 VDC	100 mA at 24 VDC	100 mA at 24 VDC	100 mA at 5 VDC	100 mA at 5 VDC	2 A at 24 VDC	2 A at 24 VDC	2 A at 24 VDC
	Auxiliary contact block Mirror contact	–	–	–	–	–	–	■	■	■
	Momentary test button	–	–	–	–	□	□	–	–	–
Relay terminals	Screw	□	□	□	□	□	□	□	□	□
	Quick-connect	□	□	□	□	□	□	–	–	–
	PCB terminals	□	□	□	□	□	□	–	–	–
Mounting	Screw	–	–	–	–	–	–	□	□	□
	DIN rail	–	–	–	–	–	–	□	□	□
	Clip (screw)	□	□	□	□	□	□	–	–	–
	Flange (screw)	□	□	□	□	□	□	–	–	–
	DIN rail (adapter)	–	–	–	–	□	□	–	–	–

■ Standard    □ Available    – No/not available

## COMPACT SOLID STATE RELAYS



### G3□ series – Reliable interfacing and power switching

Omron offers Solid State Relays (SSRs) in a wide variety of output currents and voltages to handle frequently cycling loads. Control-panel mount types with built-in heat-sink (G3PE) and without (G3NA) are ideal for power switching. Compact SSRs for I/O Interfacing include ultra-slim G3RV and G3R with high-speed models.

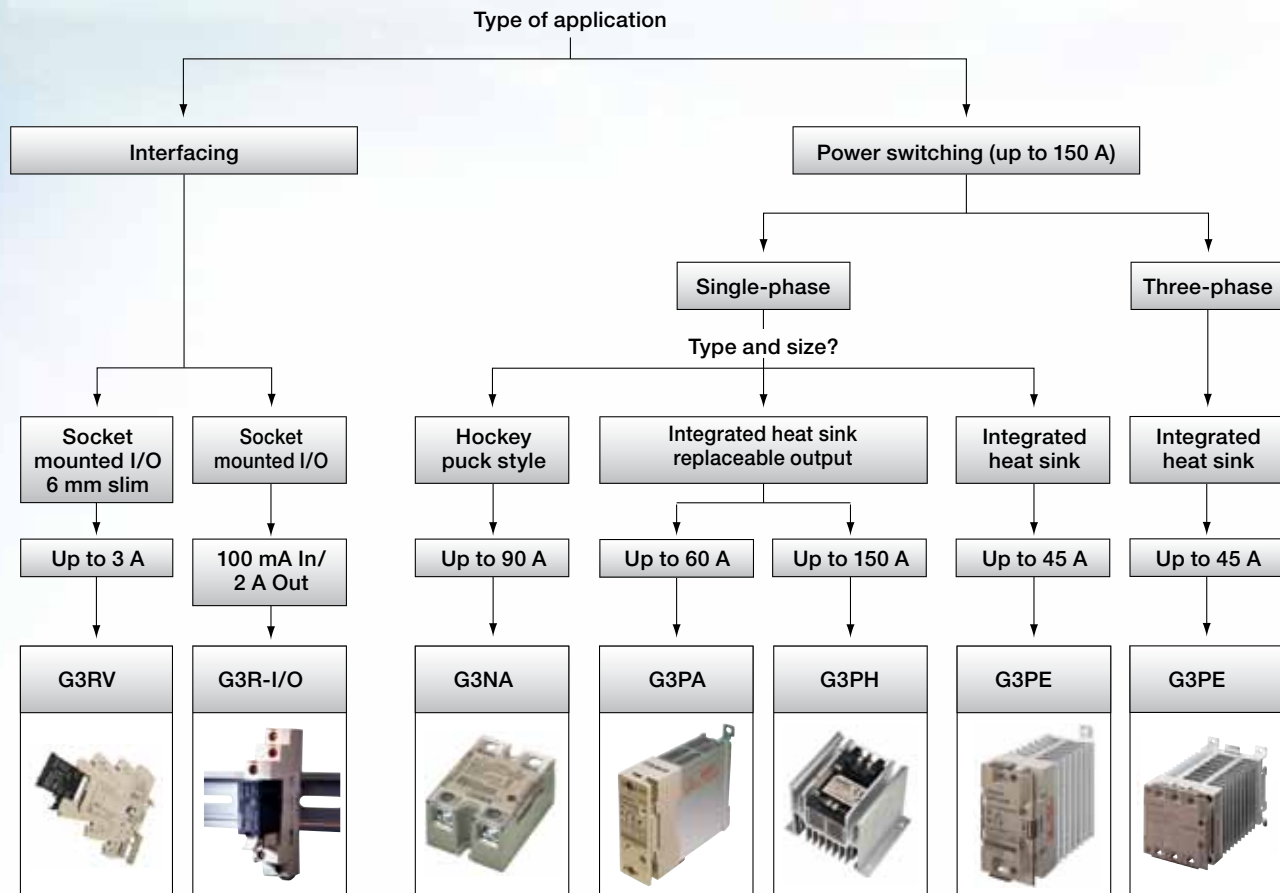
- Industrial 6 mm 'slim' SSR which is G2RV compatible (G3RV)
- G2RS compatible high-speed interface solutions (G3R-I/O)
- G3NA with 5-90 A output current, G3PB up to 45 A
- Output voltages up to 480 VAC / 200 VDC available on G3NA
- Effectively absorbing of external surge thanks to the built-in varistor



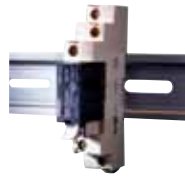



# Selection Table

		Category	Control panel mounting type			
						
Selection criteria	Model	G3RV	G3R-I/O		G3NA	
	Type of load	Output module	Input module	Output module	<ul style="list-style-type: none"> <li>• Normal resistors</li> <li>• Middle and long wave IR heater</li> <li>• Transformers and inductors</li> </ul>	
	1-phase control	–	–	–	■	
	2-phase control	–	–	–	–	
	3-phase control	–	–	–	–	
	Function	Signal switching	Signal switching	Signal switching	<ul style="list-style-type: none"> <li>• Heater control</li> <li>• Motor control</li> </ul>	
Load voltage/ current	A	Max. current rating	2 A (AC) 3 A (DC)	100 mA (DC)	2 A (AC, DC) 1.5 A (DC)	90 A (AC) 10 A (DC)
		24 to 240	–	–	–	■
	VAC	100 to 240	■	–	–	–
		200 to 480	–	–	–	■
		VDC	5 to 200	3 to 26.4	4 to 32	■
Input voltages [VDC or VAC]	5 to 24 VDC	–	■	■	■	
	12 to 24 VDC	12 VDC ±10% 24 VDC ±10%	■	–	■	
	24 VAC	■24 VAC/DC ±10%	–	–	–	
	100 to 120 VAC	■110 VAC ±10%	■	–	■	
	200 to 240 VAC	■230 VAC ±10%	■	–	■	
	Analog input	–	–	–	–	
Features	Built-in heat sink	–	–	–	–	
	Zero-cross	□	–	□	■	
	Built-in varistor	–	–	–	■	
	LED operation indicator	■	■	■	■	
	Protective cover	N/A	N/A	N/A	■	
	3-phase loads via 3 single-phase SSRs	N/A	N/A	N/A	■	
	Replaceable power cartridge	–	–	–	–	
	Alarm output	N/A	N/A	N/A	–	
	Built-in failure detection	N/A	N/A	N/A	–	
	SSR open circuits detection	N/A	N/A	N/A	–	
	SSR short circuits detection	N/A	N/A	N/A	–	
Mounting	DIN-rail	■	–	–	■	
	Screw	–	–	–	■	
	Mounting socket	■	■	■	–	

■ Standard    □ Available    – No/not available

# Solid State Relays

P

Category		Control panel mounting type				
						
Selection criteria	Model	<b>G3PA</b>	<b>G3PH</b>	<b>G3PE (1-phase)</b>	<b>G3PE (3-phase)</b>	
	Type of load	<ul style="list-style-type: none"> <li>• Normal resistors</li> <li>• Middle and long wave IR heater</li> <li>• Transformers and inductors</li> </ul>	<ul style="list-style-type: none"> <li>• Normal resistors</li> <li>• Middle and long wave IR heater</li> <li>• Transformers and inductors</li> </ul>	<ul style="list-style-type: none"> <li>• Normal resistors</li> <li>• Middle and long wave</li> <li>• IR heater</li> </ul>	<ul style="list-style-type: none"> <li>• Normal resistors</li> </ul>	
	1-phase control	■	■	■	–	
	2-phase control	–	–	–	■	
	3-phase control	–	–	–	■	
	Function	Heater control	Heater control	Heater control	Heater control	
Load voltage/ current	A	Max. current rating	60 A (AC)	75 A, 150 A (AC)	45 A (AC)	
		24 to 240	■	–	–	–
	VAC	100 to 240	–	■	–	–
		180 to 480	–	■	■	■
		200 to 480	■	–	■	■
VDC	5 to 200	–	–	–	–	
Input voltages [VDC or VAC]	5 to 24 VDC	■	■	–	–	
	12 to 24 VDC	■	–	■	■	
	24 VAC	■	–	–	–	
	100 to 240 VAC	–	■	–	–	
	200 to 240 VAC	–	–	–	–	
	Analog input	–	–	–	–	
Features	Built-in heat sink	■	■	■	□	
	Zero-cross	■	□	□	■	
	Built-in varistor	■	■	–	–	
	LED operation indicator	■	–	■	■	
	Protective cover	■	■	■	■	
	3-phase loads via 3 single-phase SSRs	■	–	■	–	
	Replaceable power cartridge	■	■	–	–	
	Alarm output	–	–	–	–	
	Built-in failure detection	–	–	–	–	
	SSR open circuits detection	–	–	–	–	
	SSR short circuits detection	–	–	–	–	
Mounting	DIN-rail	■	–	■	■	
	Screw	■	■	■	■	
	Mounting socket	–	–	–	–	

■ Standard    □ Available    – No/not available

# Relays

---

## General Purpose Plug-in Ultra Slim Relay Switching 6 A @ 250 VAC

The G2RV is an ultra-slim 6 mm wide DIN mount relay-socket unit with maintenance friendly features.

- Mechanical indicator and socket LED provide quick verification relay is operational
- Reliable connection achieved via large terminal-receptacle cross sectional area
- Electrical Life of 100K Cycles typical for lasting performance
- Interface and cable accessories allow PLC control of G2RV Relays
- Cross Bars provide a quick and easy way to connect multiple G2RV Relays together
- RoHS Compliant; Relay-Socket models cULus Listed; VDE, CE, and cULus approved



## Ordering Information

Rated resistive load	Contact form	Socket terminals	LED indicator on socket	Coil voltage	Model
6 A @ 250 VAC	SPDT	Push-in terminals	Yes	110 VAC	G2RV-SL500 AC110
				24 VDC	G2RV-SL500 DC24(DC21)
6 A @ 250 VAC	SPDT	Screw terminals	Yes	24 VAC/24 VDC	G2RV-SL700 AC/DC24
				110 VAC	G2RV-SL700 AC110
				230 VAC	G2RV-SL700 AC230
				12 VDC	G2RV-SL700 DC12(DC11)
				24 VDC	G2RV-SL700 DC24(DC21)



## Slim High-Value Relay Ideal for Automation Applications

The G2R□-S is a maintenance-friendly 5A-10 A 1/2 inch wide general purpose relay.

- Mechanical indicator comes standard allowing user to verify contact operation
- Space-saving DIN mount and finger safe G2R□-S Sockets just 16 mm wide
- Energy-efficient DC Coil power consumption approximately 530 mW
- RoHS Compliant; UL, CSA, CE, and VDE Approved



## Ordering Information

Rated resistive load	Contact form	Terminal type	LED indicator	Diode	Lockable test button	Coil voltage	Model
10 A @ 250 VAC	SPDT	Plug-in	No	No	No	120 VAC	G2R-1-S AC120 (S)
10 A @ 250 VAC	SPDT	Plug-in	No	No	No	24 VDC	G2R-1-S DC24 (S)
10 A @ 250 VAC	SPDT	Plug-in	Yes	No	No	120 VAC	G2R-1-SN AC120 (S)
10 A @ 250 VAC	SPDT	Plug-in	Yes	Yes	No	24 VDC	G2R-1-SND DC24 (S)
10 A @ 250 VAC	SPDT	Plug-in	Yes	Yes	Yes	24 VDC	G2R-1-SNDI DC24 (S)
5 A @ 250 VAC	DPDT	Plug-in	No	No	No	24 VDC	G2R-2-S DC24 (S)
5 A @ 250 VAC	DPDT	Plug-in	Yes	No	No	120 VAC	G2R-2-SN AC120 (S)
5 A @ 250 VAC	DPDT	Plug-in	Yes	Yes	No	24 VDC	G2R-2-SND DC24 (S)
5 A @ 250 VAC	DPDT	Plug-in	Yes	Yes	Yes	24 VDC	G2R-2-SNDI DC24 (S)
5 A @ 250 VAC	DPDT	Plug-in	Yes	No	Yes	120 VAC	G2R-2-SNI AC120 (S)

## Versatile, Multi-featured, Miniature Power Relay

The MY is a multi-pole long life general purpose relay ideal for elevator applications.

- DPDT models: 500K life cycles; 4PDT models: 200K (100K bifurcated) at Rated Load
- MY2K Latching relays: Great option for reduced energy consumption
- MY4Z bifurcated models can switch loads under 1 mA at 1 VDC; great for PLC Control
- RoHS Compliant; UL, CSA, CE, VDE, SEV, and IMQ Approved



## Ordering Information

Factory rated resistive load	Contact form	Terminal type	Bifurcated model	Lockable test button	LED indicator	Diode	Coil voltage	Model
3 A @ 250 VAC	DPDT	Plug-in	No	No	No	No	120 VAC	MY2K-US AC120*
5 A @ 250 VAC	DPDT	Plug-in	No	No	Yes	No	110/120 VAC	MY2N AC110/120 (S)
5 A @ 250 VAC	DPDT	Plug-in	No	No	Yes	No	220/240 VAC	MY2N AC220/240 (S)
5 A @ 250 VAC	DPDT	Plug-in	No	No	Yes	Yes	24 VDC	MY2N-D2 DC24 (S)
5 A @ 250 VAC	4PDT	Plug-in	No	No	No	No	24 VDC	MY4 DC24 (S)
3 A @ 250 VAC	4PDT	PCB	No	No	No	No	12 VDC	MY4-02 DC12
3 A @ 250 VAC	4PDT	Plug-in	No	Yes	Yes	No	110/120 VAC	MY4IN AC110/120 (S)
3 A @ 250 VAC	4PDT	Plug-in	No	No	Yes	Yes	24 VDC	MY4N-D2 DC24 (S)
3 A @ 250 VAC	4PDT	Plug-in	Yes	Yes	Yes	No	24 VDC	MY4ZIN DC24 (S)
3 A @ 250 VAC	4PDT	Plug-in	Yes	No	Yes	No	110/120 VAC	MY4ZN AC110/120 (S)

\* This model is a latching relay.

## Long Life 10 A General Purpose Relay Ideal for HVAC and Appliance Market

The LY is a reliable multi-pole general purpose relay with Quick Connect or PCB Terminals.

- 500K life cycles DPDT models; 200K for SPDT, 3PDT, and 4PDT models at rated load
- Long life ideal for Appliances and HVAC Systems
- Plug-in models installed in OEM equipment allows for quick and easy replacement
- RoHS Compliant; UL, CSA, CE, and TUV Approved



## Ordering Information

Rated resistive load	Contact form	Mounting rating	UL horsepower rating	LED indicator	Diode	Coil voltage	Model
15 A @110 VAC	SPDT	Socket	0.5 HP @ 120 VAC	No	No	110/120 VAC	LY1 AC110/120
15 A @110 VAC	SPDT	Flange	0.5 HP @ 120 VAC	No	No	24 VDC	LY1F DC24
10 A @110 VAC	DPDT	Socket	0.5 HP @ 120 VAC	No	No	24 VAC	LY2 AC24
10 A @110 VAC	DPDT	Flange	0.5 HP @ 120 VAC	No	No	24 VDC	LY2F DC24
10 A @110 VAC	DPDT	Socket	0.5 HP @ 120 VAC	Yes	Yes	110/120 VAC	LY2N AC110/120
10 A @110 VAC	DPDT	Socket	0.5 HP @ 120 VAC	Yes	Yes	24 VDC	LY2N-D2 DC24
10 A @110 VAC	DPDT	PCB	0.5 HP @ 120 VAC	No	No	120 VAC	LY2-0 AC110/120
10 A @110 VAC	DPDT	PCB	0.5 HP @ 120 VAC	No	No	12 VDC	LY2-0 DC12
10 A @110 VAC	3PDT	Socket	0.5 HP @ 240 VAC	No	No	120 VAC	LY3 AC120
10 A @110 VAC	4PDT	Socket	0.5 HP @ 240 VAC	No	No	24 VDC	LY4 DC24

## Exceptionally Reliable General Purpose Relay now available with Lockable Test Button

Two- and three-pole socket mount relays with UL Rated 10 A resistive Load @ 250 VAC/ 30 VDC, and 100K cycles.

- Mechanical indicator comes standard, allowing user to verify contact operation
- Manual and locked position testing possible when using MKS Test Button Models
- LED indicator models come with white name plate ideal for marking key notes on it
- RoHS Compliant; cULus Recognized; CE, and TUV Approved



## Ordering Information

Rated resistive load (NO Contact)	Contact form	Terminal type	Lockable test button	LED indicator	Coil voltage	Model
10 A @ 250 VAC/30 VDC	DPDT	Plug-In	No	No	120 VAC	MKS2P AC120
10 A @ 250 VAC/30 VDC	DPDT	Plug-In	Yes	No	12 VDC	MKS2PI DC12
10 A @ 250 VAC/30 VDC	DPDT	Plug-In	Yes	Yes	24 VAC	MKS2PIN AC24
10 A @ 250 VAC/30 VDC	DPDT	Plug-In	Yes	Yes	24 VDC	MKS2PIN DC24
10 A @ 250 VAC/30 VDC	DPDT	Plug-In	No	Yes	120 VAC	MKS2PN AC120
10 A @ 250 VAC/30 VDC	3PDT	Plug-In	No	No	12 VDC	MKS3P-5 DC12
10 A @ 250 VAC/30 VDC	3PDT	Plug-In	Yes	No	24 VDC	MKS3PI-5 AC24
10 A @ 250 VAC/30 VDC	3PDT	Plug-In	Yes	No	24 VDC	MKS3PI-5 DC24
10 A @ 250 VAC/30 VDC	3PDT	Plug-In	Yes	Yes	24 VDC	MKS3PIN-5 DC24
10 A @ 250 VAC/30 VDC	3PDT	Plug-In	No	Yes	120 VAC	MKS3PN-5 AC120

## 44 mm Tall AC or DC Load Relays with High Maximum Switching Capacity

Maximum switching capacity of 2200 W for DC and 3750 VAC for AC SPST-NO models.

- MKS-X Socket Mount Relays are at least 4 mm shorter versus main competitors
- Manual and locked position testing possible when using MKS-X Test Button Models
- Wide range of coil voltages available including 220 VDC
- RoHS Compliant; cULus Recognized; CE, and TUV Approved



## Ordering Information

Rated resistive load (NO Contact)	Contact form	Terminal type	Lockable test button	LED indicator	Coil voltage	Model
15 A @ 250 VAC	SPST-NO	Plug-In	Yes	Yes	120 VAC	MKS1TIN-10 AC120
10 A @ 220 VDC	SPST-NO	Plug-In	No	No	240 VAC	MKS1XT-10 AC240
10 A @ 220 VDC	SPST-NO	Plug-In	No	No	24 VDC	MKS1XT-10 DC24
10 A @ 220 VDC	SPST-NO	Plug-In	Yes	No	120 VAC	MKS1XTI-10 AC120
10 A @ 220 VDC	SPST-NO	Plug-In	Yes	No	24 VDC	MKS1XTI-10 DC24
10 A @ 220 VDC	SPST-NO	Plug-In	Yes	Yes	24 VDC	MKS1XTIN-10 DC24
10 A @ 220 VDC	SPST-NO	Plug-In	No	Yes	24 VDC	MKS1XTN-10 AC24
5 A @ 220 VDC	SPST-NO + SPST-NC	Plug-In	No	No	24 VDC	MKS2XT-11 DC24
5 A @ 220 VDC	SPST-NO + SPST-NC	Plug-In	Yes	Yes	120 VAC	MKS2XTIN-11 AC120

## Multi-Pole 10-30 A General Purpose Relay with 600 VAC Maximum Switching Voltage

The MJN is an SPDT, DPDT, and 3PDT general purpose relay ideal for motor applications.

- UL and CSA Recognized as motor controllers up to 600 VAC
- 10 A models have UL 1/3 HP @ 120 VAC Rating addressing horse power rated motors
- Rugged power driver offers 3/16" clearance and 3/8" creepage
- 30 A MJN models have 15 A @ 600 VAC load rating good for AC load switching > 277 VAC
- 10 A DPDT latching models available; a good option for reducing power consumption.



## Ordering Information

Rated resistive load	Contact form	Mounting style	Latching model	LED indicator	Test button	Coil voltage	Model
10 A @ 240 VAC/28 VDC	SPDT	Panel	No	No	No	12 VDC	MJN1CF-DC12
30 A @ 28 VDC	SPDT	Panel	No	No	No	120 VAC	MJN1Z-E-RP-AC120
10 A @ 240 VAC/28 VDC	DPDT	Socket	No	No	No	110 VDC	MJN2C-DC110
20 A @ 277 VAC/28 VDC	DPDT	Panel	No	No	No	120 VAC	MJN2C-E-AC120
10 A @ 240 VAC/28 VDC	DPDT	Panel	No	No	No	24 VAC	MJN2CF-AC24
10 A @ 240 VAC/28 VDC	DPDT	Socket	Yes	No	No	120 VAC	MJN2CK-AC120
10 A @ 240 VAC/28 VDC	3PDT	Socket	No	Yes	Yes	120 VAC	MJN3C-IN-AC120
10 A @ 240 VAC/28 VDC	3PDT	Socket	No	Yes	No	24 VDC	MJN3C-N-DC24
10 A @ 240 VAC/28 VDC	3PDT	Socket	No	Yes	No	110 VDC	MJN3C-N-DC110

## Multi-Pole Heavy Duty 25 A NO Contact General Purpose Relay

The G7J is a multi-pole general purpose relay ideal for switching motors, compressors, and pump controls.

- UL 3 HP @ 277 VAC (NO contact)
- UL 3-phase rating of 5 HP @ 277 VAC, 30K Cycles
- UL general use rating of 25 A, 240 VAC, 100K Cycles (NO contact)
- UL 1.5 kW @ 120 VAC Tungsten Rating (NO contact)
- RoHS Compliant; UL, CSA approved



## Ordering Information

Rated resistive load (NO Contact)	Contact form	Terminal type	Coil voltage	Model
25 A @ 220 VAC	DPST-NO, DPST-NC	Screw	200/240 VAC	G7J-2A2B-B-W1 AC200/240
25 A @ 220 VAC	DPST-NO, DPST-NC	Screw	24 VDC	G7J-2A2B-B-W1 DC24
25 A @ 220 VAC	DPST-NO, DPST-NC	Quick-Connect	100/120 VAC	G7J-2A2B-T-W1 AC100/120
25 A @ 220 VAC	3PST-NO, SPST-NC	Screw	24 VDC	G7J-3A1B-BZ DC24
25 A @ 220 VAC	3PST-NO, SPST-NC	Screw	100/120 VAC	G7J-3A1B-W1 AC100/120
25 A @ 220 VAC	4PST-NO	Screw	100/120 VAC	G7J-4A-B-W1 AC100/120
25 A @ 220 VAC	4PST-NO	Screw	200/240 VAC	G7J-4A-B-W1 AC200/240
25 A @ 220 VAC	4PST-NO	Screw	24 VDC	G7J-4A-B-W1 DC24

## Heavy Duty General Purpose Relay Ideal for Pump and Motor Applications

The G7L is a high-capacity maximum value general purpose relay with variety of mounting options.

- UL Rating of 3 HP @ 277 VAC, 100K Cycles addressing horse power rated motors
- UL Rating of 20 FLA/ 120 LRA, 120 VAC, 30,000 Cycles addressing FLA/LRA rated motors
- Manages very high short-term surges with 10,000 VAC Impulse Withstand Voltage Rating
- RoHS Compliant; UL, CSA, and TUV
- Approved (G7L with “80” are VDE Approved)



## Ordering Information

AC inductive load rating (NO Contact)	Contact form	Terminal type	Coil voltage	Model
30 A @ 220 VAC	SPST-NO	Screw	12 VDC	G7L-1A-BUBJ-CB DC12
30 A @ 220 VAC	SPST-NO	Quick Connect	100/120 VAC	G7L-1A-T-CB AC100/120
30 A @ 220 VAC	SPST-NO	Quick Connect	100/120 VAC	G7L-1A-TUBJ-CB AC100/120
30 A @ 220 VAC	SPST-NO	Quick Connect	24 VDC	G7L-1A-TUBJ-CB DC24
30 A @ 220 VAC	DPST-NO	Screw	200/240 VAC	G7L-2A-BUBJ-CB AC200/240
30 A @ 220 VAC	DPST-NO	Screw	12 VDC	G7L-2A-BUBJ-CB DC12
30 A @ 220 VAC	DPST-NO	PCB	24 VDC	G7L-2A-P-CB DC24
30 A @ 220 VAC	DPST-NO	Quick Connect	24 VDC	G7L-2A-TJ-CB AC24
30 A @ 220 VAC	DPST-NO	Quick Connect	24 VDC	G7L-2A-TUBJ-CB DC24
30 A @ 220 VAC	DPST-NO	Quick Connect	100/120 VAC	G7L-2A-TUBJ-CB AC100/120



## Heavy Duty General Purpose Relay with Class F Coil Insulation

The MGN is a rugged general purpose relay with high maximum operating temperature great for heavy duty HVAC and Motor Loads.

- UL rating of 30 A @ 240 VAC/28 VDC and 20 A @ 600 VAC
- UL Ballast rating of 3.6 kW @ 120 VAC
- -45C to +115C DC coil operating temperature good for temperature extreme applications
- Short Circuit Current Rating (SCCR) of 5 kA @ 600 VAC
- Magnetic blow-out models switch up to 20 A @ 125 VDC (resistive)
- cULus Listed making it ideal for panel makers needing a “stand alone” relay



## Ordering Information

Rated resistive load	Contact form	Terminal type	Size in inches (L x W x H)	UL horsepower rating	Coil voltage	Model
30 A @ 240 VAC	SPDT	Screw	2.5 x 2.5 x 2.2	1.5 HP @ 120 VAC	24 VAC	MGN1C-AC24
30 A @ 240 VAC	SPDT	Screw	2.5 x 2.5 x 2.2	1.5 HP @ 120 VAC	120 VAC	MGN1C-AC120
30 A @ 240 VAC	DPST-NO	Screw	2.5 x 2.5 x 2.2	1.5 HP @ 120 VAC	120 VAC	MGN2A-AC120
30 A @ 240 VAC	DPST-NO	Screw	2.5 x 2.5 x 2.2	1.5 HP @ 120 VAC	24 VDC	MGN2A-DC24
30 A @ 240 VAC	DPDT	Screw	3.4 x 2.5 x 2.4	1.5 HP @ 120 VAC	120 VAC	MGN2C-AC120
30 A @ 240 VAC	DPDT	Screw	3.4 x 2.5 x 2.4	1.5 HP @ 120 VAC	12 VDC	MGN2C-DC12
30 A @ 240 VAC	DPDT	Screw	3.4 x 2.5 x 2.4	1.5 HP @ 120 VAC	24 VDC	MGN2C-DC24
20 A @ 125 VAC	DPDT	Screw	3.4 x 2.5 x 2.4	1.5 HP @ 120 VAC	24 VDC	MGN2CM-DC24

## Miniature 40 A Energy-Efficient Contactor

The G7Z is a multi-pole power relay that can switch and carry 40 A @ 440 VAC.

- 40% less volume versus typical IEC 50 A contactor great for limited space panels
- 3.7 W approximate power consumption about 50% lower than typical IEC 50 A contactor
- 4PST-NO models can carry up to 160 A by wiring all 4 NO Contacts in parallel
- Applications include solar energy systems, robotic equipment, and grinding machines
- Auxiliary contacts can switch loads under 10 mA @ 5 VDC = controllable by PLC
- RoHS Compliant; cULus Recognized, CE, and TUV Approved



## Ordering Information

Rated resistive load (NO Contact)	AC inductive load rating (NO Contact)	Contact form	Mounting style	Coil voltage	Model
40 A @ 440 VAC	22 A @ 440 VAC	DPST-NO, DPST-NC	DIN/panel	24 VDC	G7Z-2A2B DC24
40 A @ 440 VAC	22 A @ 440 VAC	DPST-NO, DPST-NC	DIN/panel	24 VDC	G7Z-2A2B-02Z DC24
40 A @ 440 VAC	22 A @ 440 VAC	DPST-NO, DPST-NC	DIN/panel	24 VDC	G7Z-2A2B-11Z DC24
40 A @ 440 VAC	22 A @ 440 VAC	3PST-NO, SPST-NC	DIN/panel	24 VDC	G7Z-3A1B-11Z DC24
40 A @ 440 VAC	22 A @ 440 VAC	4PST-NO	DIN/panel	24 VDC	G7Z-4A-02Z DC24
40 A @ 440 VAC	22 A @ 440 VAC	4PST-NO	DIN/panel	24 VDC	G7Z-4A-11Z DC24
40 A @ 440 VAC	22 A @ 440 VAC	4PST-NO	DIN/panel	24 VDC	G7Z-4A-20Z DC24

## Ultra-Slim Compact 1-2A PCB Solid State Relays Ideal for Input/Output Applications

PCB mount DC input AC output SSR with width < 0.2"

- Great for high-density close PCB mounting with square area of 0.18 inches squared
- Manage surge between input and output with “-1” models (3000 V isolation)
- Ability to switch 2 A loads at 120 VAC or 240 VAC with “202P” models
- Minimize surge and input noise by utilizing models with zero cross
- RoHS Compliant; “VD” Models have UL, CSA, and VDE Approval



## Ordering Information

Input voltage	Load voltage	Load current	Size in mm L x W x H	Zero cross	Isolation (input/output)	Model
5 VDC	100 to 120 VAC	0.1 to 1 A	24.5 x 4.5 x 13.5	Yes	2500 VAC	G3MC-101P DC5
5 VDC	100 to 120 VAC	0.1 to 1 A	24.5 x 4.5 x 13.5	Yes	2500 VAC	G3MC-101P-VD DC5
5 VDC	100 to 240 VAC	0.1 to 2 A	24.5 x 4.5 x 20.5	Yes	2500 VAC	G3MC-202P-VD DC5
24 VDC	100 to 240 VAC	0.1 to 2 A	24.5 x 4.5 x 20.5	Yes	3000 VAC	G3MC-202P-VD-1 DC24
5 VDC	100 to 240 VAC	0.1 to 2 A	24.5 x 4.5 x 20.5	No	2500 VAC	G3MC-202PL-VD DC5
12 VDC	100 to 240 VAC	0.1 to 2 A	24.5 x 4.5 x 20.5	No	2500 VAC	G3MC-202PL-VD DC12

## Input/Output Color Coded PCB Solid State Relays with LED Indicator Models

The G3TB is a PCB mount Input/Output solid state relay with width < 0.4 inches.

- Manage high-surge between input and output with 4000 V isolation
- Verify input current is flowing through relay by viewing LED indicator
- Easy to identify type of I/O relay thanks to unique color assigned to each
- Minimize surge and input noise by utilizing AC output types with zero cross
- RoHS Compliant; “US” Models have UL and CSA Approval



## Ordering Information

Input voltage	Load voltage	Load current	Size in mm L x W x H	Zero cross	Relay color	Model
100 to 240 VAC	4 to 32 VDC	25 mA max.	44 x 10 x 21	No	Yellow	G3TB-IAZR02P-US AC100-240
5 to 24 VDC	100 to 240 VAC	0.05 to 3 A	44 x 10 x 31	Yes	Black	G3TB-OA203PZ-US DC5-24
5 to 24 VDC	5 to 48 VDC	0.01 to 3 A	44 x 10 x 31	No	Red	G3TB-ODX03PM-US DC4-24

## Solid State Plug-in Ultra-Slim Relay Ideal for Automation Applications

The G3RV is an ultra-slim 6 mm wide solid state relay DIN mount relay-socket unit with maintenance-friendly features

- Verify input current is flowing through relay by viewing LED indicator
- Large plug-in terminal area and snug slot configuration ensure reliable connection
- Long electrical life of 10+ years possible thanks to SSR having zero moving parts
- PLC control of G3RV-SL700 Relays possible via interface and cable accessories
- Quickly and easily connect multiple G3RV Relays together with Cross Bars
- RoHS Compliant; Relay-Socket models cULus Listed; CE and TUV Approval

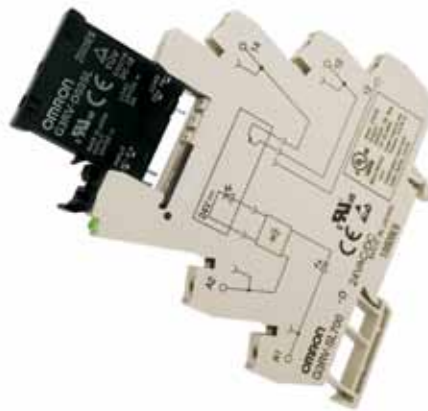

## Ordering Information

Terminal wiring connection	Load voltage	Load current	Input voltage	Zero cross	Mounting	Model
Push-in wire	100 to 240 VAC	0.1 to 2 A	230 VAC	Yes	DIN track	G3RV-SL500-A AC230
Push-in wire	100 to 240 VAC	0.1 to 2 A	24 VDC	Yes	DIN track	G3RV-SL500-A DC24
Push-in wire	5 to 24 VDC	100 $\mu$ A to 3 A	230 VAC	No	DIN track	G3RV-SL500-D AC230
Push-in wire	5 to 24 VDC	100 $\mu$ A to 3 A	24 VDC	No	DIN track	G3RV-SL500-D DC24
Screw	100 to 240 VAC	0.1 to 2 A	110 VAC	Yes	DIN track	G3RV-SL700-A AC110
Screw	100 to 240 VAC	0.1 to 2 A	230 VAC	Yes	DIN track	G3RV-SL700-A AC230
Screw	100 to 240 VAC	0.1 to 2 A	24 VDC	Yes	DIN track	G3RV-SL700-A DC24
Screw	5 to 24 VDC	100 $\mu$ A to 3 A	110 VAC	No	DIN track	G3RV-SL700-D AC110
Screw	5 to 24 VDC	100 $\mu$ A to 3 A	230 VAC	No	DIN track	G3RV-SL700-D AC230
Screw	5 to 24 VDC	100 $\mu$ A to 3 A	24 VDC	No	DIN track	G3RV-SL700-D DC24

## Input/Output 0.5” Wide Socket Mount Solid State Relay

The G3R is a high isolation solid state relay ideal for input/output applications.

- Manage high-surge between input and output with 4000 VAC isolation
- Process high-speed inputs using G3R-IDZR models: 0.1 ms max. On/Off time
- Switch up to a 2 A @ 240 VAC with AC load output models
- Verify input current is flowing through relay by viewing LED indicator
- SSR equivalent to G2RS-S Relay with potential life of 10+ years
- RoHS Compliant; “UTU” Models have UL, CSA, and TUV Approval



## Ordering Information

Input voltage	Load voltage	Load current	Size in mm L x W x H	Zero cross	Mounting	Model
5 VDC	4 to 32 VDC	0.1 to 100 mA	29 x 13 x 28	No	Socket	G3R-IDZR1SN DC5
12 to 24 VDC	4 to 32 VDC	0.1 to 100 mA	29 x 13 x 28	No	Socket	G3R-IDZR1SN DC12-24
5 to 24 VDC	100 to 240 VAC	0.05 to 2 A	29 x 13 x 28	Yes	Socket	G3R-OA202SZN DC5-24
5 to 24 VDC	100 to 240 VAC	0.05 to 2 A	29 x 13 x 28	Yes	Socket	G3R-OA202SZN-UTU DC5-24
5 to 24V DC	48 to 200 VDC	0.01 to 1.5 A	29 x 13 x 28	No	Socket	G3R-OD201SN DC5-24
5 to 24 VDC	5 to 48 VDC	0.01 to 2 A	29 x 13 x 28	No	Socket	G3R-ODX02SN DC5-24
5 to 24 VDC	5 to 48 VDC	0.01 to 2 A	29 x 13 x 28	No	Socket	G3R-ODX02SN-UTU DC5-24

## Single-Phase SSR with 5-90 A Models in Standard Hockey Puck Size

The G3NA Relays are panel mount SSRs with more than 50% of models made being RoHS compliant, including G3NA-205B, 210B, 220B, 225B, 240B, 250B, 410B, 420B, 610B, 625B, 650B, and D210B Models.

- Minimize surge and input noise by utilizing AC load models with zero cross
- Built-in plastic cover provides shock protection while turning screw terminals
- Manage short-term surges thanks to built-in varistor
- All models have UL and CSA Approval; “UTU” models also have TUV Approval



## Ordering Information

Input voltage	Load voltage	Load current	Size in mm L x W x H	Zero cross	Mounting	Model
5 to 24 VDC	24 to 240 VAC	0.1 to 5 A	58 x 43 x 27	Yes	Panel	G3NA-205B DC5-24
100 to 120 VAC	24 to 240 VAC	0.1 to 10 A	58 x 43 x 27	Yes	Panel	G3NA-210B AC100-120
5 to 24 VDC	24 to 240 VAC	0.1 to 10 A	58 x 43 x 27	Yes	Panel	G3NA-210B DC5-24
5 to 24 VDC	24 to 240 VAC	0.1 to 10 A	58 x 43 x 27	Yes	Panel	G3NA-210B-UTU DC5-24
100 to 120 VAC	24 to 240 VAC	0.1 to 20 A	58 x 43 x 27	Yes	Panel	G3NA-220B AC100-120
5 to 24 VDC	24 to 240 VAC	0.1 to 20 A	58 x 43 x 27	Yes	Panel	G3NA-220B DC5-24
5 to 24 VDC	24 to 240 VAC	0.1 to 40 A	58 x 43 x 30	Yes	Panel	G3NA-240B DC5-24
5 to 24 VDC	200 to 480 VAC	0.2 to 40 A	58 x 43 x 30	Yes	Panel	G3NA-440B-2 DC5-24
100 to 240 VAC	24 to 240 VAC	0.1 to 75 A	58 x 43 x 28	Yes	Panel	G3NA-275B-UT-2 AC100-240
5 to 24 VDC	24 to 240 VAC	0.1 to 90 A	58 x 43 x 30	Yes	Panel	G3NA-290B-UT-2 DC5-24
5 to 24 VDC	5 to 200 VDC	0.1 to 10 A	58 x 43 x 27	No	Panel	G3NA-D210B DC5-24

## Compact 5-20 A Panel Mount Solid State Relay

The G3NE is a space-efficient solid state relay switching 5 A, 10 A, or 20 A load @ 100-240 VAC.

- G3NE Relays have 65% less volume versus standard hockey puck relays
- G3NE Relays cover 30% less area versus standard hockey puck relays
- Fast wiring possible using quick-connect input and output terminals with slip-on terminal clips
- Manage short term surges thanks to built-in varistor
- RoHS Compliant; “US” Models have UL, CSA, and TUV Approval



## Ordering Information

Input voltage	Load voltage	Load current	Size in mm L x W x H	Zero cross	Mounting	Model
5 VDC	100 to 240 VAC	0.1 to 5 A	48 x 38 x 12	Yes	Panel	G3NE-205T-US DC5
12 VDC	100 to 240 VAC	0.1 to 5 A	48 x 38 x 12	Yes	Panel	G3NE-205T-US DC12
24 VDC	100 to 240 VAC	0.1 to 5 A	48 x 38 x 12	Yes	Panel	G3NE-205T-US DC24
5 VDC	100 to 240 VAC	0.1 to 10 A	48 x 38 x 12	Yes	Panel	G3NE-210T-US DC5
12 VDC	100 to 240 VAC	0.1 to 10 A	48 x 38 x 12	Yes	Panel	G3NE-210T-US DC12
24 VDC	100 to 240 VAC	0.1 to 10 A	48 x 38 x 12	Yes	Panel	G3NE-210T-US DC24
5 VDC	100 to 240 VAC	0.1 to 10 A	48 x 38 x 12	Yes	Panel	G3NE-210T-2-US DC5
5 VDC	100 to 240 VAC	0.1 to 20 A	48 x 38 x 12	Yes	Panel	G3NE-220T-US DC5
12 VDC	100 to 240 VAC	0.1 to 20 A	48 x 38 x 12	Yes	Panel	G3NE-220T-US DC12
24 VDC	100 to 240 VAC	0.1 to 20 A	48 x 38 x 12	Yes	Panel	G3NE-220T-US DC24



## Industrial Solid State Relays with Outstanding Transient Voltage Suppression

The G3PE is a 15-45 A solid state relay able to suppress transient voltages of 30kV+.

- Quick and easy DIN mounting possible using built-in sink models
- Single-phase 15 A and 25 A models occupy less than 1" of DIN track width
- Side-by-side mounting of eight relays possible for single phase models
- Minimize surge and input noise by utilizing AC load models with zero cross
- Switch single, two, or three phase loads with a 1, 2, or 3 pole G3PE Relay
- All models are RoHS Compliant and have UL, CSA, CE, and TUV Approvals



## Ordering Information

Input voltage	Load voltage	Load current	Size in mm L x W x H	Zero cross	Number of poles	Model
12 to 24 VDC	100 to 240 VAC	0.1 to 15 A	100 x 22.5 x 100	Yes	1	G3PE-215B DC12-24
12 to 24 VDC	100 to 240 VAC	0.1 to 15 A	100 x 22.5 x 100	Yes	1	G3PE-225B DC12-24
12 to 24 VDC	100 to 240 VAC	0.5 to 35 A	100 x 44.5 x 100	Yes	1	G3PE-235B DC12-24
12 to 24 VDC	100 to 240 VAC	0.5 to 45 A	100 x 44.5 x 100	Yes	1	G3PE-245B DC12-24
12 to 24 VDC	200 to 480 VAC	0.5 to 15 A	100 x 80 x 155	Yes	3	G3PE-515B-3N DC12-24
12 to 24 VDC	200 to 480 VAC	0.5 to 25 A	100 x 80 x 155	Yes	2	G3PE-525B-2N DC12-24
12 to 24 VDC	200 to 480 VAC	0.5 to 25 A	120 x 80 x 155	Yes	3	G3PE-525B-3N DC12-24
12 to 24 VDC	200 to 480 VAC	0.5 to 35 A	120 x 80 x 155	Yes	2	G3PE-535B-2N DC12-24
12 to 24 VDC	200 to 480 VAC	0.5 to 35 A	140 x 80 x 155	Yes	3	G3PE-535B-3N DC12-24
12 to 24 VDC	200 to 480 VAC	0.1 to 45 A	140 x 110 x 155	Yes	3	G3PE-545B-3N DC12-24

## High Value SSR with Integrated Heat Sink and Replaceable Element

The G3PA is a high value DIN mount SSRs switching 10-60 A Loads.

- Quick and easy DIN mounting thanks to built-in heat sink
- Manage high-surge between input and output with 4000 VAC Isolation
- Side-by-side mounting of 3 relays possible with G3PA linking brackets
- Reduce replacement cost and wiring time by using G3PA power cartridges
- 3 phase switching with G3PAs possible with G32A-D accessory cartridge
- RoHS Compliant; “VD” Models have UL, CSA, CE, and VDE Approval



## Ordering Information

Input voltage	Load voltage	Load current	Size in mm L x W x H	Zero cross	Mounting	Model
24 VAC	24 to 240 VAC	0.1 to 10 A	100 x 27 x 100	Yes	DIN/panel	G3PA-210B-VD AC24
5 to 24 VDC	24 to 240 VAC	0.1 to 10 A	100 x 27 x 100	Yes	DIN/panel	G3PA-210B-VD DC5-24
5 to 24 VDC	24 to 240 VAC	0.1 to 10 A	100 x 27 x 100	No	DIN/panel	G3PA-210BL-VD DC5-24
5 to 24 VDC	24 to 240 VAC	0.1 to 10 A	100 x 37 x 100	Yes	DIN/panel	G3PA-220B-VD DC5-24
5 to 24 VDC	24 to 240 VAC	0.5 to 40 A	100 x 47 x 100	Yes	DIN/panel	G3PA-240B-VD DC5-24
5 to 24 VDC	24 to 240 VAC	0.5 to 60 A	110 x 100 x 100	Yes	DIN/panel	G3PA-260B-VD DC5-24
12 to 24 VDC	180 to 400 VAC	0.5 to 20 A	100 x 37 x 100	Yes	DIN/panel	G3PA-420B-VD DC12-24
12 to 24 VDC	180 to 400 VAC	0.5 to 30 A	100 x 47 x 100	Yes	DIN/panel	G3PA-430B-VD DC12-24
12 to 24 VDC	200 to 480 VAC	0.5 to 30 A	100 x 47 x 100	Yes	DIN/panel	G3PA-430B-VD-2 DC12-24
12 to 24 VDC	200 to 480 VAC	0.5 to 50 A	110 x 100 x 100	Yes	DIN/panel	G3PA-450B-VD-2 DC12-24

## High Power SRR with Heat Sink Offers Replaceable Output Module

Shallow mounting depth and NEMA 4/IP66 front panel without additional protection.

- Advanced programmable display with twin timer function
- PNP/NPN input
- Programmable via front or DIP switches on back
- Water-resistant IP66 front panel



## Ordering Information



Insulation method	Operation indicator	Zero cross function	Applicable output load	Rated input voltage	Model
Photocoupler	Yes (yellow)	Yes	75 A, 100 to 240 VAC	5 to 24 VDC	G3PH-2075B DC5-24
				100 to 240 VAC	G3PH-2075B AC100-240
			150 A, 100 to 240 VAC	5 to 24 VDC	G3PH-2150B DC5-24
				100 to 240 VAC	G3PH-2150B AC100-240
		No	75 A, 100 to 240 VAC	5 to 24 VDC	G3PH-2075BL DC5-24
				5 to 24 VDC	G3PH-2150BL DC5-24
			150 A, 100 to 240 VAC	5 to 24 VDC	G3PH-2075BL DC5-24
				5 to 24 VDC	G3PH-2150BL DC5-24
		Yes	75 A, 180 to 480 VAC	5 to 24 VDC	G3PH-5075B DC5-24
				100 to 240 VAC	G3PH-5075B AC100-240
			150 A, 180 to 480 VAC	5 to 24 VDC	G3PH-5150B DC5-24
				100 to 240 VAC	G3PH-5150B AC100-240
No	75 A, 180 to 480 VAC	5 to 24 VDC	G3PH-5075BL DC5-24		
	150 A, 180 to 480 VAC	5 to 24 VDC	G3PH-5150BL DC5-24		

## Ultra-Slim 22 mm Current Monitoring Relays

- Monitor industrial equipment for over-currents and undercurrents
- Manual resetting and automatic resetting supported in one relay
- Start-up lock and operating time can be set separately
- Output relay can be switched between normally open and normally closed contacts
- Monitor output from commercially available current transformers (0 to 1 A, 0 to 5 A)
- Monitor output status from LED indicator
- Track-mount or surface-mount with M4 screws
- Dimensions: 90 H x 22.5 W x 100 D mm



## Ordering Information

Description	Features	Input current	Output	Model
Ultra-slim 22 mm Current Monitoring Relays	Over and Undercurrent	2 to 20 mA AC/DC 10 to 100 mA AC/DC 50 to 500 mA AC/DC	SPDT relay, 6A at 250 VAC	K8AB-AS1 24 VACDC
				K8AB-AS1 100-115 VAC
				K8AB-AS1 200-230 VAC
		0.1 to 1 A AC/DC 0.5 to 5 A AC/DC 0.8 to 8 A AC/DC		K8AB-AS2 24 VACDC
				K8AB-AS2 100-115 VAC
				K8AB-AS2 200-230 VAC
		10 to 100 A AC/DC, 20 to 200 A AC/DC; requires K8AC-CT200L Current transformer		K8AB-AS3 24 VACDC
				K8AB-AS3 100-115 VAC
				K8AB-AS2 200-230 VAC

## Ultra-Slim 22 mm Phase Monitoring Relays

Phase monitoring relay (K8AB-PH) distinguishes between positive phases, reversed phases and phase loss when power is turned ON; prevents reversed motor rotation due to incorrect wiring.

- Monitor 3-phase voltage asymmetry (K8AB-PA)
- Monitor 3-phase power supplies (K8AB-PM) for over-voltages, undervoltages, phase sequence and phase loss
- Monitor over-voltages and undervoltages (K8AB-PW) for 3-phase power supplies
- 3-wire and 4-wire power supply input, field selectable
- Monitor output status from LED indicator
- Track-mount or surface-mount with M4 screws
- Dimensions: 90 H x 22.5 W x 100 D mm



## Ordering Information

Description	Features	Input voltage	Output	Model
Phase-sequence, Phase-loss relay	For 3-phase source; prevents reverse motor rotation due to incorrect wiring	200 to 500 VAC	SPDT relay, 6 A @ 250 VAC	K8AB-PH1
3-Phase voltage, phase-sequence, phase loss relay	Over and under voltage (window comparator) Operation level and time settings	200, 220, 230, or 240 VAC	2 x SPDT relays 6 A @ 250 VAC	K8AB-PM1
		380, 400, 425 or 480 VAC		K8AB-PM2
3-Phase asymmetry, phase-sequence, phase-loss relay	Operation level and time settings	200, 220, 230 or 240 VAC	2 x SPDT relay 6 A @ 250 VAC	K8AB-PA1
		380, 400, 415 or 480 VAC		K8AB-PA2
3-Phase voltage relay	Over and undervoltage (window comparator)	200, 220, 230 or 240 VAC	2 x SPDT relay 6 A @ 250 VAC	K8AB-PW1
		380, 400, 415 or 480 VAC		K8AB-PW2

## Ultra-Slim 22 mm Voltage Monitoring Relays

- Monitor overvoltage and undervoltage simultaneously with independent settings and outputs
- Manual resetting and automatic resetting supported by one relay
- Pre-alarm monitoring mode enables early warning of conditions to take preventative action
- Monitor output status from LED indicator
- Track-mount or surface mount with M4 screws
- Dimensions: 90 H x 22.5 W x 100 D mm



## Ordering Information

Description	Features	Input voltage	Output	Model
1-Phase Voltage Relay	Over- and undervoltage	6 to 60 mV AC/DC, 10 to 100 mV AC/DC, 30 to 300 mV AC/DC	SPDT relay, 6 A at 250 VAC	K8AB-VS1 100-115 VAC
				K8AB-VS1 24 VACDC
				K8AB-VS2 100-115 VAC
		1 to 10 V AC/DC, 3 to 30 V AC/DC, 15 to 150 V AC/DC		K8AB-VS2 24 VACDC
				K8AB-VS3 100-115 VAC
				K8AB-VS3 24 VACDC
1-Phase Voltage Relay, Window Comparator	Over- and undervoltage, window comparator	6 to 60 mV AC/DC, 10 to 100 mV AC/DC, 30 to 300 mV AC/DC	2 x SPDT relays, 6 A at 250 VAC	K8AB-VW1 100-115 VAC
				K8AB-VW1 24 VACDC
				K8AB-VW2 100-115 VAC
		1 to 10 V AC/DC, 3 to 30 V AC/DC, 15 to 150 V AC/DC		K8AB-VW2 24 VDC
				K8AB-VW3 100-115 VAC
				K8AB-VW3 24 VDC

# Relays

---

## Contents

<b>Selection Guide</b>		<b>Q-ii</b>
<b>22 mm dia. pushbutton switches with metal bezel, lighted or non-lighted, IP65</b>		
<b>A22R/</b>	Pushbutton switches	<b>Q-1</b>
<b>A22RL</b>	Lighted pushbutton switches	
<b>A22RS/</b>	Selector switches	<b>Q-2</b>
<b>A22RW</b>	Lighted selector switches	
<b>A22RK</b>	Keyed selector switches	<b>Q-3</b>
<b>M22R</b>	Pilot lights	<b>Q-4</b>
<b>22 mm dia. pushbutton switches with plastic bezel, lighted or non-lighted, IP65, round or square</b>		
<b>A22/</b>	Pushbutton switches	<b>Q-5</b>
<b>A22L</b>	Lighted pushbutton switches	
<b>A22E/</b>	Emergency stop switches	<b>Q-6</b>
<b>A22EL</b>	Lighted emergency stop switches	
<b>A22S/</b>	Selector switches	<b>Q-7</b>
<b>A22W</b>	Lighted selector switches	
<b>A22K</b>	Keyed selector switches	<b>Q-8</b>
<b>M22</b>	Pilot lights	<b>Q-9</b>
<b>16 mm dia. pushbutton switches with plastic bezel, lighted or non-lighted, IP40 or IP65, round, square or rectangular</b>		
<b>A16/</b>	Pushbutton switches	<b>Q-10</b>
<b>A16L/</b>	Lighted pushbutton switches	
<b>A165/</b>	IP65 Pushbutton switches	
<b>A165L</b>	IP65 Lighted pushbutton switches	
<b>A165E/</b>	Emergency stop switches	<b>Q-11</b>
<b>A165EL</b>	Lighted emergency stop switches	
<b>A165S/</b>	Selector switches	<b>Q-12</b>
<b>A165W</b>	Lighted selector switches	
<b>A165K</b>	Keyed selector switches	<b>Q-13</b>
<b>M16/</b>	Pilot lights	<b>Q-14</b>
<b>M165</b>	IP65 Pilot lights	
<b>M2BJ</b>	Panel-mounted buzzer	<b>Q-15</b>



## 22 MM SUB-ASSEMBLED PUSHBUTTON SWITCHES

### A22R and A22 - Full range with IP65 rating

All our 22 mm pushbuttons are rated IP65 to increase the reliability in your application. The short mounting depth, ease of assembly and uniform lighting make them ideal for your control panels.

- Easy assembly and installation
- Metal or plastic bezel
- Wide range of shapes and colors

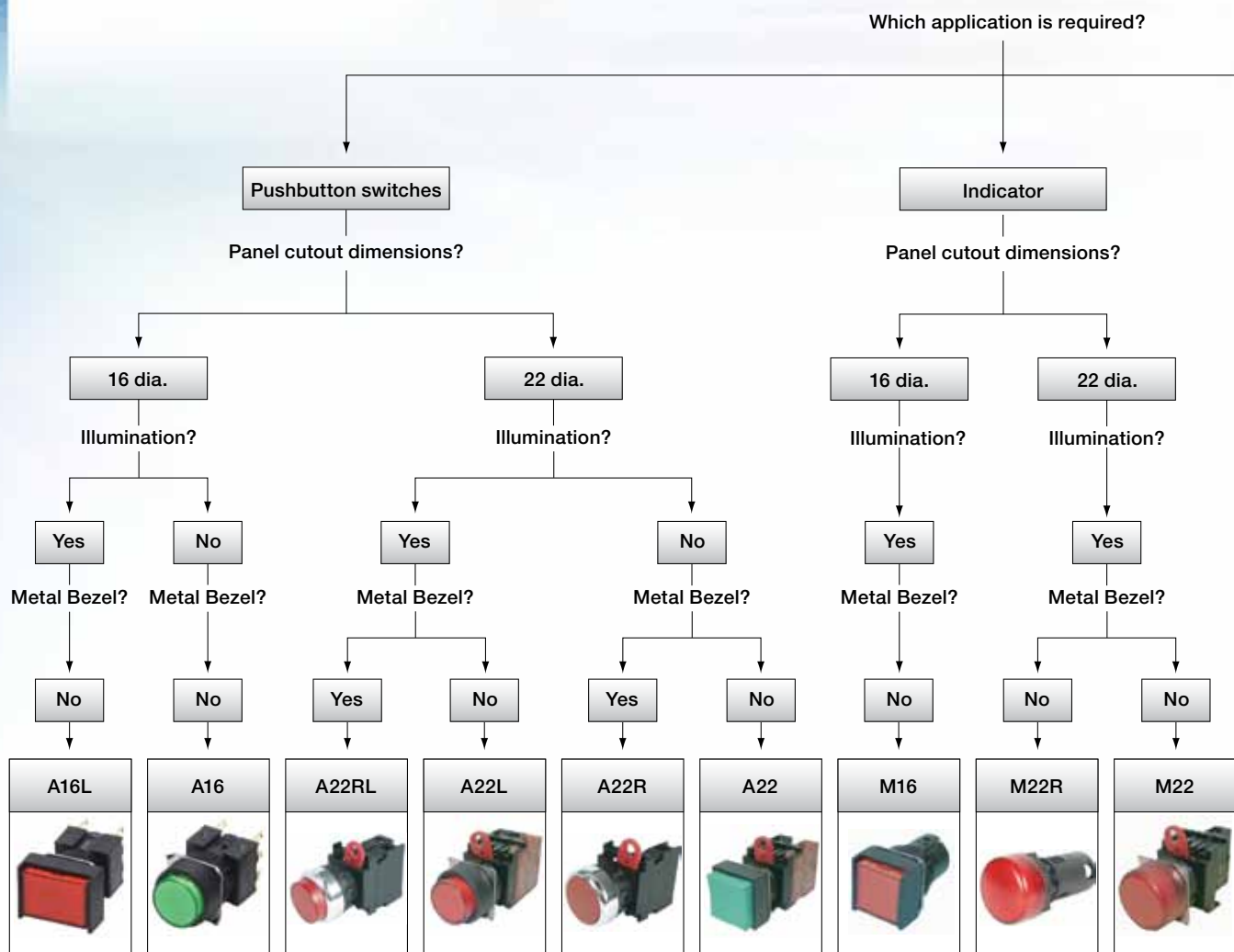

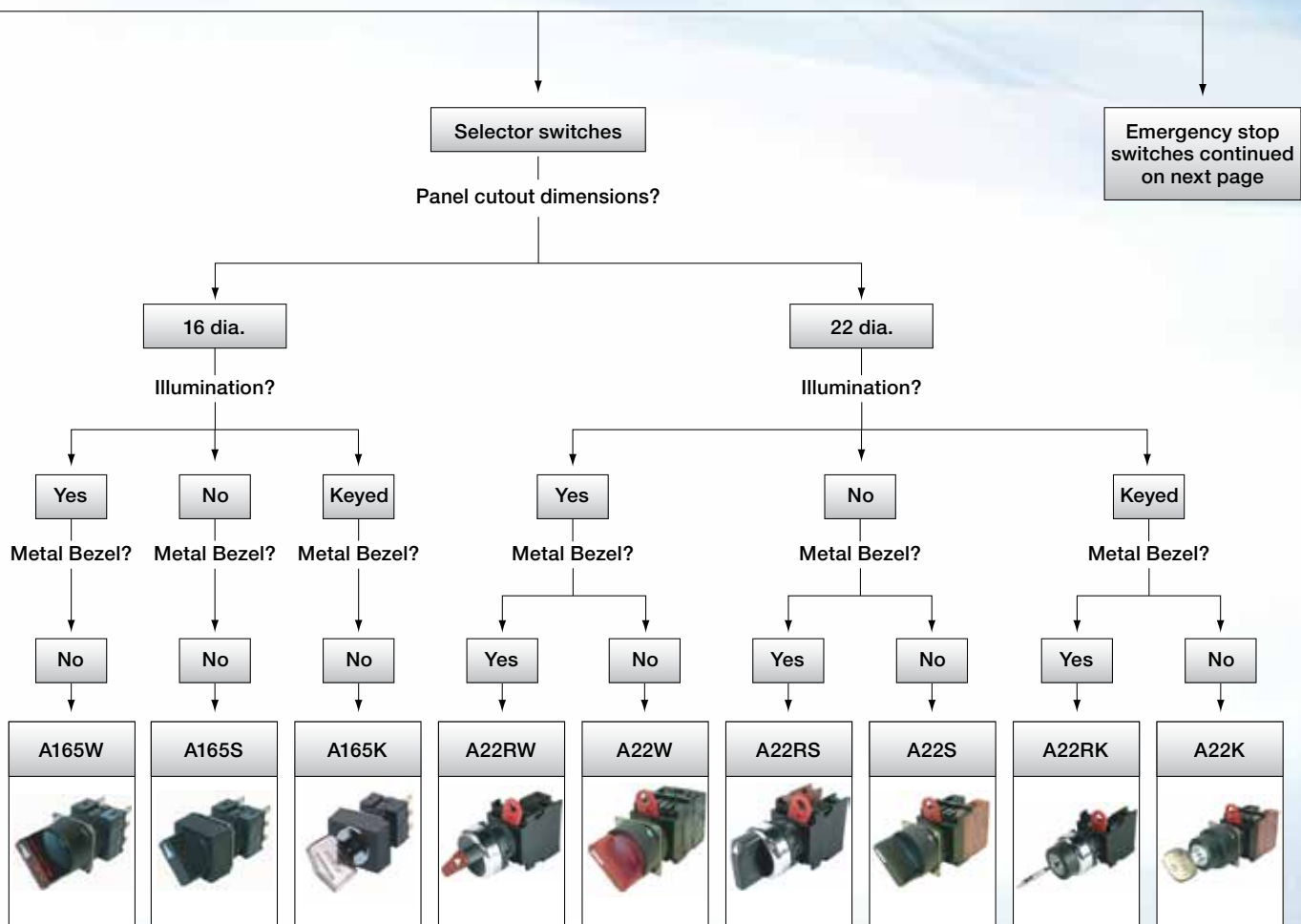



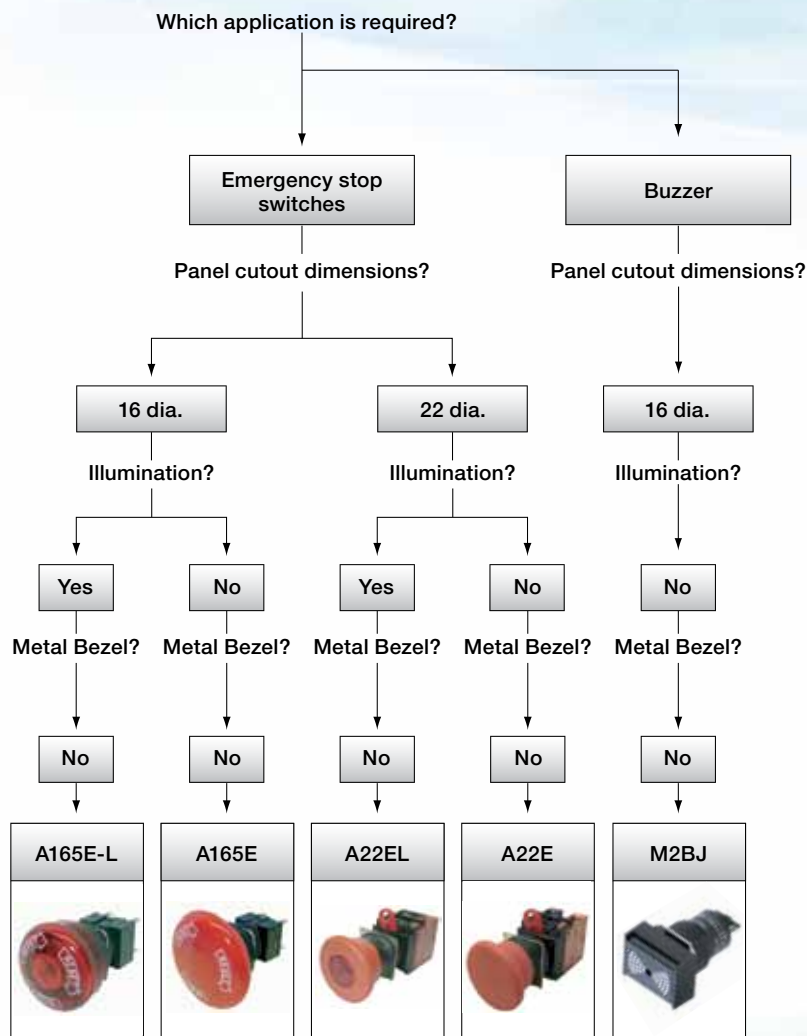









# Pushbutton Switches

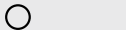



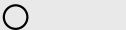



# Pushbutton Switches

Category		Pushbutton switch				Indicator			
									
Selection criteria	Model	A16	A165	A22R	A22	M16	M165	M22R	
	Mounting	Nut-mounting							
	Size	16 mm	16 mm	22 mm	22 mm	16 mm	16 mm	22 mm	
	Shape								
Pushbutton color	LED-lighted	Red	■	■	■	■	■	■	
		Yellow	■	■	■	■	■	■	
		Pure yellow	■	■	—	—	■	■	—
		Green	■	■	■	■	■	■	■
		White	■	■	■	■	■	■	■
		Blue	■	■	■	■	■	■	■
	Non-lighted	Red	■	■	■	■	■	■	■
		Yellow	■	■	■	■	■	■	■
		Green	■	■	■	■	■	■	■
		White	■	■	■	■	■	■	■
		Blue	■	■	■	■	■	■	■
		Black	■	■	■	■	■	■	■
	Features	Momentary operation	■	■	■	■	—	—	—
		Self-holding	■	■	■	■	—	—	—
2-position selector		—	—	—	—	—	—	—	
3-position selector		—	—	—	—	—	—	—	
Number of contacts		1 or 2	1 or 2	1 or 2	1 or 2	—	—	—	
IP rating		IP40	IP65	IP65	IP65	IP40	IP65	IP65	
	Legend plate	■	■	■	■	■	■	■	
	Switch ratings (Resistive load)	<ul style="list-style-type: none"> <li>• 5 A, 125 VAC</li> <li>• 3 A, 250 VAC</li> <li>• 3 A, 30 VDC</li> </ul>	<ul style="list-style-type: none"> <li>• 5 A, 125 VAC</li> <li>• 3 A, 250 VAC</li> <li>• 3 A, 30 VDC</li> </ul>	<ul style="list-style-type: none"> <li>• 3 A, 240 VAC</li> </ul>	<ul style="list-style-type: none"> <li>• 10 A, 110 VAC</li> <li>• 6 A, 220 VAC</li> <li>• 10 A, 24 VDC</li> </ul>	—	—	—	
Terminals	Solder	■	■	—	—	■	■	—	
	PCB	■	■	—	—	■	■	—	
	Screw-less clamp	■	■	—	—	■	■	—	
	Screw	—	—	■	■	—	—	■	
LED Operating voltage	5 VDC	■	■	—	—	■	■	—	
	6 VDC	—	—	■	■	—	—	■	
	12 VDC	■	■	■	■	■	■	■	
	24 VDC	■	■	■	■	■	■	■	
	110 VAC	■	■	—	■	■	■	—	
	220 VAC	■	■	■	■	■	■	■	
Form	SPDT	■	■	—	—	—	—	—	
	DPDT	■	■	—	—	—	—	—	
	SPST-NO	—	—	■	■	—	—	—	
	SPST-NC	—	—	■	■	—	—	—	
	SPST-NO + SPST-NC	—	—	■	■	—	—	—	
	DPST-NO	—	—	■	■	—	—	—	
	DPST-NC	—	—	■	■	—	—	—	

■ Standard    □ Available    — No/not available







Q

# Selection Table

Category		Indicator	Selector switch						
									
Selection criteria	Model	M22	A165W	A165S	A165K	A22RW	A22RS	A22W	
	Mounting	Nut-mounting							
	Size	22 mm	16 mm	16 mm	16 mm	22 mm	22 mm	22 mm	
	Shape	□ ○	□ □ ○	□ □ ○	□ □ ○	○	○	○	
Pushbutton color	LED-lighted	Red	■	■	■	—	■	■	■
		Yellow	■	■	■	—	■	■	■
		Pure yellow	—	—	—	—	—	—	—
		Green	■	■	■	—	■	■	■
		White	■	—	—	—	—	■	—
		Blue	■	—	—	—	■	■	■
	Non-lighted	Red	■	■	■	—	—	■	■
		Yellow	■	■	■	—	—	■	■
		Green	■	■	■	—	—	■	■
		White	■	—	—	—	—	■	—
		Blue	■	—	—	—	—	■	■
		Black	■	■	■	■	—	■	—
Features	Momentary operation	—	—	—	—	—	—	—	
	Self-holding	—	—	—	—	—	—	—	
	2-position selector	—	■	■	■	■	—	■	
	3-position selector	—	■	■	■	■	—	■	
	Number of contacts	—	1.2	1 or 2	1 or 2	1 or 2	—	1 or 2	
	IP rating	IP65	IP65	IP65	IP65	IP65	IP65	IP65	
	Legend plate	■	—	—	—	—	■	—	
	Switch ratings (Resistive load)	—	• 5 A, 125 VAC • 3 A, 250 VAC • 3 A, 30 VDC	• 5 A, 125 VAC • 3 A, 250 VAC • 3 A, 30 VDC	• 5 A, 125 VAC • 3 A, 250 VAC • 3 A, 30 VDC	• 3 A, 240 VAC	• 3 A, 240 VAC	• 10 A, 110 VAC • 6 A, 220 VAC • 10 A, 24 VDC	
Terminals	Solder	—	■	■	■	—	—	—	
	PCB	—	■	■	■	—	—	—	
	Screw-less clamp	—	■	■	■	—	—	—	
	Screw	■	—	—	—	■	■	■	
LED Operating voltage	5 VDC	—	■	—	—	—	—	—	
	6 VDC	■	—	—	—	■	—	■	
	12 VDC	■	■	—	—	■	—	■	
	24 VDC	■	■	—	—	■	—	■	
	110 VAC	■	■	—	—	—	—	■	
	220 VAC	■	■	—	—	■	—	■	
Form	SPDT	—	■	■	■	—	—	—	
	DPDT	—	■	■	■	—	—	—	
	SPST-NO	—	—	—	—	■	■	■	
	SPST-NC	—	—	—	—	■	■	■	
	SPST-NO + SPST-NC	—	—	—	—	■	■	■	
	DPST-NO	—	—	—	—	■	■	■	
	DPST-NC	—	—	—	—	■	■	■	

■ Standard    □ Available    — No/not available

# Pushbutton Switches

Category		Selector switch			Emergency stop switch		Buzzer	
								
Selection criteria	Model	A22S	A22RK	A22K	A165E	A22E	M2JB-B	
	Mounting	Nut-mounting						
	Size	22 mm	22 mm	22 mm	16 mm	22 mm	16 mm	
	Shape	○	○	○	○	○	□	
Pushbutton color	LED-lighted	Red	■	-	-	■	■	-
		Yellow	■	-	-	-	-	-
		Pure yellow	-	-	-	-	-	-
		Green	■	-	-	-	-	-
		White	-	-	-	-	-	-
	Non-lighted	Red	■	-	-	■	■	-
		Yellow	■	-	-	-	-	-
		Green	■	-	-	-	-	-
		White	-	-	-	-	-	-
		Blue	■	-	-	-	-	-
Features	Black	■	■	■	-	-	■	
	Momentary operation	-	-	-	-	-	-	
	Self-holding	-	-	-	■	■	-	
	2-position selector	■	■	■	-	-	-	
	3-position selector	■	■	■	-	-	-	
	Number of contacts	1 or 2	1 or 2	1 or 2	1 or 2	1 or 2	-	
	IP rating	IP65	IP65	IP65	IP65	IP65	IP40	
Legend plate	-	-	-	-	-	-		
Switch ratings (Resistive load)		<ul style="list-style-type: none"> <li>• 10 A, 110 VAC</li> <li>• 6 A, 220 VAC</li> <li>• 10 A, 24 VDC</li> </ul>	<ul style="list-style-type: none"> <li>• 3 A, 240 VAC</li> </ul>	<ul style="list-style-type: none"> <li>• 10 A, 110 VAC</li> <li>• 6 A, 220 VAC</li> <li>• 10 A, 24 VDC</li> </ul>	<ul style="list-style-type: none"> <li>• 5 A, 125 VAC</li> <li>• 3 A, 250 VAC</li> <li>• 3 A, 30 VDC</li> </ul>	<ul style="list-style-type: none"> <li>• 10 A, 110 VAC</li> <li>• 10 A, 24 VDC</li> </ul>	-	
Terminals	Solder	-	-	-	■	-	■	
	PCB	-	-	-	-	-	-	
	Screw-less clamp	-	-	-	-	-	-	
	Screw	■	■	■	-	■	-	
LED Operating voltage	5 VDC	-	-	-	■	-	-	
	6 VDC	-	-	-	-	■	-	
	12 VDC	-	-	-	■	■	-	
	24 VDC	-	-	-	■	■	-	
	110 VAC	-	-	-	-	■	-	
	220 VAC	-	-	-	-	■	-	
Form	SPDT	-	-	-	-	-	-	
	DPDT	-	-	-	-	-	-	
	SPST-NO	■	■	■	-	-	-	
	SPST-NC	■	■	■	■	■	-	
	SPST-NO + SPST-NC	■	■	■	-	-	-	
	DPST-NO	■	■	■	-	-	-	
	DPST-NC	■	■	■	■	■	-	

■ Standard    □ Available    - No/not available



# Pushbuttons & Indicators

---

## 22 mm Dia. Lighted and Non-Lighted Pushbutton Switches



- Robust and aesthetic design
- Shiny metal bezel
- Smooth rounded edges
- Short mounting depth, less than 46.8 mm below panel



## Specifications

- Rated load: 3 A at 240 VAC
- Enclosure rating: IP65
- Rated durability service life:
  - Mechanical:
    - 3,000,000 operations - Momentary switch
    - 300,000 operations – Alternate switch
  - Electrical: 500,000 operations



Round flat		A22R-F
Round projection		A22R-T

Lighted		Model
Lighted round projection		A22RL-T



## 22 mm Dia. Lighted and Non-Lighted Selector Switches

- 2- and 3-position switches with manual or automatic reset to meet panel building needs
- New “super-bright” LED used in all lighted models
- Short mounting depth, less than 46.8 mm below panel
- “Snap-in” switch unit for quick and easy tool-free assembly
- Shiny metal bezel



## Specifications

- Rated load: 3 A at 240 VAC
- Enclosure rating: IP65
- Rated durability service life:
  - Mechanical: 300,000 operations
  - Electrical: 500,000 operations

Non-Lighted		Model
Non-lighted selector switch		A22RS

Lighted		Model
Lighted selector switch		A22RW

## 22 mm Dia. Keyed Non-Lighted Selector Switches

- Design in extra security with keyed selector switches; only authorized operators are allowed to change settings using the key
- 2- and 3-position switches with manual or automatic reset to meet panel building needs
- Short mounting depth, less than 46.8 mm below panel
- “Snap-in” switch unit for quick and easy tool-free assembly
- Shiny metal bezel



## Specifications

- Rated load: 3 A at 240 VAC
- Enclosure rating: IP65
- Rated durability service life:
  - Mechanical: 300,000 operations
  - Electrical: 500,000 operations

Keyed		Model
Keyed selector switch		A22RK

## 22 mm Dia. Pilot Lights

- Pilot lights indicate status of machinery and processes on control panels
- Bright LED light source is easy to read under most lighting conditions
- Easy mounting and removal of socket unit
- Short mounting depth, less than 40.5 mm below panel



## Specifications

- Current consumption:  
20 mA @ 12 V AC/DC  $\pm 5\%$   
20 mA @ 24 V AC/DC  $\pm 5\%$
- Enclosure rating: IP65

Pilot lights		Model
Round flat pilot light		M22R

## 22 mm Dia. Lighted and Non-Lighted Pushbutton Switches



- Wide range of options to match most panel building needs
- IP65 rated for oil resistance
- Lighting: Non-lighted (A22) and lighted (A22L)
- Short mounting depth, less than 54.7 mm below panel (momentary)
- “Snap-in” switch unit for quick and easy, tool-free assembly
- RoHS compliant



## Specifications

- Rated load (SPDT, DPDT):
  - 10 A at 110 VAC, 10 A at 220 VAC (NO & NC)
  - 10 A at 24 VDC
  - Microload types: 50 mA @ 24 VDC; 1 mA @ 5 VDC min. applicable load
- Total travel force: 29.4 N max.
- Rated durability service life:
  - Mechanical: 5,000,000 operations min.
  - Electrical: 500,000 operations min.
- Approvals:
  - UL: UL508, File No. E41515
  - cUL: CSA C22 No. 14
  - TÜV: EN60947-5-1:2004
  - CCC: GB14048.5

Non-Lighted		Model
Round flat		A22-F
Round projection		A22-T
Round full guard		A22-G
Round half guard		A22-H
Square projection		A22-C
Square Guard		A22-D

Non-Lighted		Model
Round mushroom head 30 mm dia.		A22-S
Round mushroom head 40 mm dia.		A22-M

Lighted		Model
Lighted round projection		A22L-T
Lighted round full guard		A22L-G
Lighted round half guard		A22L-H
Lighted square projection		A22L-C
Lighted square guard		A22L-D

## 22 mm Dia. Lighted and Non-Lighted Emergency Stop Switches

Use these e-stop switches as part of a Safety Category 4 system

- Direct opening mechanism opens the circuit when the contact welds
- Safety lock mechanism prevents operating errors
- Easily mount and remove switch blocks using a lever
- Mount three switch units in series to improve wiring efficiency
- Finger protection mechanism on switch unit provided as a standard feature
- Install using either round or forked crimp terminals
- Oil-resistant to IP65



## Specifications

- Rated load (SPDT, DPDT):
  - 10 A at 110 VAC, 10 A at 220 VAC (NO & NC)
  - 10 A at 24 VDC
  - Microload types: 50 mA @ 24 VDC; 10 mA @ 5 VDC min applicable load
- Total travel force: 44.1 N max
- Rated durability service life:
  - Mechanical: 300,000 operations min.
  - Electrical: 300,000 operations min.
- Approvals:
  - UL: UL508, File No. E41515
  - cUL: CSA C22 No. 14
  - TÜV: EN60947-5-5/A1:2005
  - CCC: GB14048.5

Push-pull		Model
Round medium 40 mm dia. Push-pull		A22E-MP

Push-lock turn-reset		Model
Round small 30 mm dia. Push-lock turn-reset		A22E-S
Round medium 40 mm dia. Push-lock turn-reset		A22E-M
Round large 60 mm dia. Push-lock turn-reset		A22E-L
Lighted round large 40 mm dia. Push-lock turn-reset		A22EL-M

## 22 mm Dia. Lighted and Non-Lighted Selector Switches

- Knob-style selector switches provide users a reliable way to start or choose between machine operations
- 2- and 3-position switches with manual or automatic reset to meet panel building needs
- IP65-rated for oil resistance
- Lighting: Non-lighted (A22S) and lighted (A22W)
- New “ultra-bright” LED used in all lighted models
- Short mounting depth, less than 54.7 mm below panel



- “Snap-in” switch unit for quick and easy tool-free assembly
- RoHS compliant

## Specifications

- Rated load (SPDT, DPDT):
  - 10 A at 110 VAC, 10 A at 220 VAC (NO & NC)
  - 10 A at 24 VDC
  - Microload types: 50 mA @ 24 VDC; 1 mA @ 5 VDC min. applicable load
- Rated durability service life:
  - Mechanical: 5,000,000 operations min.
  - Electrical: 500,000 operations min.
- Approvals:
  - UL: UL508, File No. E41515
  - cUL: CSA C22 No. 14
  - TÜV: EN60947-5-1:2004
  - CCC: GB1404.85

Non-Lighted		Model
Non-lighted selector switch		A22S

Non-Lighted		Model
Lighted selector switch		A22W

## 22 mm Dia. Keyed Selector Switches

- Design in extra security with keyed selector switches; only authorized operators are allowed to change settings using the key
- 2- and 3-position switches with manual or automatic reset to meet panel building needs
- IP65-rated for oil resistance
- Short mounting depth, less than 54.7 mm below panel
- “Snap-in” switch unit for quick and easy tool-free assembly
- RoHS compliant



## Specifications

- Rated load (SPDT, DPDT):
  - 10 A at 110 VAC, 10 A at 220 VAC (NO & NC)
  - 10 A at 24 VDC
  - Microload types: 50 mA @ 24 VDC; 1 mA @ 5 VDC min. applicable load
- Rated durability service life:
  - Mechanical: 5,000,000 operations min.
  - Electrical: 500,000 operations min.
- Approvals:
  - UL: UL508, File No. E41515
  - cUL: CSA C22 No. 14
  - TÜV: EN60947-5-1:2004
  - CCC: GB14048.5

Pilot lights		Model
Keyed selector switch		A22K

## 22 mm Dia. Pilot Lights

- Pilot lights indicate status of machinery and processes on control panels
- Bright LED light source is easy to read under most lighting conditions
- Easy mounting and removal of socket unit
- Oil-resistant, IP65 rated
- Short mounting depth, less than 54.7 mm below panel
- RoHS compliant



## Specifications

- Current consumption:
  - 8 mA @ 6 VAC/VDC  $\pm 5\%$
  - 8 mA @ 12 VAC/VDC  $\pm 5\%$
  - 8 mA @ 24 VAC/VDC  $\pm 5\%$
- Approvals:
  - UL: UL508, File No. E41515
  - cUL: CSA C22 No. 14
  - CCC: GB14098-5

Pilot lights		Model
Square projection pilot light		M22-C

Pilot lights		Model
Round flat pilot light		M22-F



# A16/A165 Series Pushbutton Switches

Quick Link

P632

## 16 mm Dia. Lighted and Non-Lighted Pushbutton Switches



- Wide range of options to match most panel building needs
- Protection: IP65 oil-resistant models (A165) and standard IP40 models (A16)
- Lighting: Non-lighted (A16 and A165) and lighted (A16L and A165L)
- New “ultra-bright” LED used in all lighted models
- Short mounting depth, less than 28.5 mm below panel









- “Snap-in” switch unit for quick and easy tool-free assembly
- RoHS compliant

## Specifications

- Rated load (SPDT, DPDT):
  - 5 A at 125 VAC, 3 A at 250 VAC (NO & NC)
  - 3 A at 30 VDC
- Operating force:
  - SPDT 2.45N/DPDT:4.41N(IP40); SPDT:2.94N/DPDT4.91 N (IP65)
- Rated durability service life:
  - Mechanical: Momentary operation: 2,000,000 operations min.; Alternating operation: 200,000 operations min.
  - Electrical: 100,000 operations min.
- Approvals:
  - UL: UL508, File No. E41515
  - cUL: CSA C22 No. 14
  - TÜV: EN60947-5-1:2004
  - CCC: GB14048.5

Round		Model
Lit and unlit round projection		A16-T, A16L-T, A165-T, A165L-T
Lighted round projection, 110 VAC transformer		A16L-T-T1, A165L-T-T1
Lighted round projection, 220 VAC transformer		A16L-T-T2, A165L-T-T2

Square		Model
Lit and unlit square 2-way guard		A16-A, A16L-A, A165-A, A165L-A
Lighted square 2-way guard, 110 VAC transformer		A16L-A-T1, A165L-A-T1
Lighted square 2-way guard, 220 VAC transformer		A16L-A-T2, A165L-A-T2

Rectangular		Model
Lit and unlit rectangular 2-way guard		A16-J, A16L-J, A165-J, A165L-J
Lighted rectangular 2-way guard 110 VAC transformer		A16L-J-T1, A165L-J-T1
Lighted rectangular 2-way guard, 220 VAC transformer		A16L-J-T2, A165L-J-T2

## 16 mm Dia. Lighted and Non-Lighted Emergency Stop Switches



Use these e-stop switches as part of a Safety Category 4 system

- Direct opening mechanism to open contacts in emergencies, such as when they are welded
- Conforms to EN60418
- Includes a safety lock to prevent misuse
- Features separate construction that allows the switch to be separated for easier wiring and one-piece-like construction that allows easier handling
- Models available with 3 contacts built into a single block (A165E-U)



## Specifications

- Rated load (SPST-NC, DPST-NC):
  - 5 A at 125 VAC, 3 A at 250 VAC (NO & NC)
  - 3 A at 30 VDC
- Operating force:
  - SPDT/DPDT: 14.7 N
- Rated durability service life:
  - Mechanical: 100,000 operations min.
  - Electrical: 100,000 operations min.
- Approvals:
  - UL: UL508, File No. E41515
  - cUL: CSA C22 No. 14

Push-lock turn-reset		Model
Lighted round 30 mm dia. Push-lock turn-reset		A165E-LS
Round 30 mm dia. Push-lock turn-reset		A165E-S
Round 40 mm dia. Push-lock turn-reset		A165E-M

## 16 mm Dia. Lighted and Non-Lighted Selector Switches

- Knob-style selector switches provide users a reliable way to start or choose between machine operations
- 2- and 3-position switches with manual or automatic reset to meet panel building needs
- IP65-rated for oil resistance
- Lighting: Non-lighted (A165S) and lighted (A165W)
- New “ultra-bright” LED used in all lighted models
- Short mounting depth, less than 28.5 mm below panel
- “Snap-in” switch unit for quick and easy tool-free assembly





- RoHS compliant
- Use optional legend plates to identify the selections

## Specifications

- Rated load (SPDT, DPDT):
  - 5 A at 125 VAC, 3 A at 250 VAC (NO & NC)
  - 3 A at 30 VDC
- Operating force:
  - SPDT/DPDT: 0.1 Nm
- Rated durability service life:
  - Mechanical: 250,000 operations min.
  - Electrical: 100,000 operations min.
- Approvals:
  - UL: UL508, File No. E41515
  - cUL: CSA C22 No. 14
  - TÜV: EN60947-5-1:2004
  - CCC: GB14048.5

Non-lighted		Model
Square base selector switch		A165S-A
Rectangular base selector switch		A165S-J
Round base selector switch		A165S-T

Lighted		Model
Lighted square base selector switch		A165W-A
Lighted rectangular base selector switch		A165W-J
Lighted round base selector switch		A165W-T



## 16 mm Dia. Keyed Selector Switches

- Design in extra security with keyed selector switches; only authorized operators are allowed to change settings using the key
- 2- and 3-position switches with manual or automatic reset to meet panel building needs
- IP65-rated for oil resistance
- Short mounting depth, less than 28.5 mm below panel
- “Snap-in” switch unit for quick and easy tool-free assembly
- RoHS compliant
- Use optional legend plates to identify the selections



## Specifications

- Rated load (SPDT, DPDT):
  - 5 A at 125 VAC, 3 A at 250 VAC (NO & NC)
  - 3 A at 30 VDC
- Operating force:
  - SPDT/DPDT: 0.1 Nm
- Rated durability service life:
  - Mechanical: 250,000 operations min.
  - Electrical: 100,000 operations min.
- Approvals:
  - UL: UL508, File No. E41515
  - cUL: CSA C22 No. 14
  - TÜV: EN60947-5-1:2004
  - CCC: GB14048.5

Keyed switches		Model
Square base keyed selector switch		A165K-A
Rectangular base keyed selector switch		A165K-J
Round base keyed selector switch		A165K-T





## 16 mm Dia. Pilot Lights

- Pilot lights indicate status of machinery and processes on control panels
- Bright LED light source is easy to read under most lighting conditions
- Easy mounting and removal of socket unit
- Standard IP40 and oil-resistant IP65 models
- Short mounting depth, less than 28.5 mm below panel
- RoHS compliant
- Use optional legend plates to identify indicators



## Specifications

- Current consumption:
  - 8 mA @ 5 VDC  $\pm 5\%$
  - 8 mA @ 12 VAC/VDC  $\pm 5\%$
  - 8 mA @ 24 VAC/VDC  $\pm 5\%$
  - 8 mA @ 110 VAC/VDC
  - 8 mA @ 220 VAC/VDC
- Approvals:
  - UL: UL508, File No. E76675
  - cUL: CSA C22 No. 14

Keyed switches		Model
Square pilot light		M16-A, M165-A
Rectangular pilot light		M16-J, M165-J
Round pilot light		M16-T, M165-T

## 16 mm Dia. Panel-Mounted Buzzers



- Four models offer eight different types of sounds, plus two modes with high-sound output
- Intermittent or continuous sound selected by jumper setting
- Jumper storage provided at bottom of unit
- Complements the A16 range of Pushbuttons, Selector Switches and Key Switches
- RoHS compliant
- LEDs incorporated on high-sound model indicators



## Specifications:

Current consumption:

- Standard sound types:
  - DC: 7 mA max.
  - AC: 20 mA max.
- High-sound (includes LED) types:
  - DC: 50 mA max.
  - AC: 100 mA max.

Buzzers		Model
Standard sound buzzer		M2BJ-B
High volume sound buzzer		M2BJ-BH

# Pushbuttons & Indicators

---

## Contents

<b>Selection Guide</b>		R-ii
<b>Limit Switches</b>		
<b>WL</b>	Robust single-pole/double break switches	R-1
<b>D4A-N</b>	Heavy-duty SPDT and DPDT switches, plug-in construction	R-2
<b>D4C</b>	Sealed, compact, slim pre-wired limit switch	R-3
<b>D4CC</b>	Sealed, compact, slim limit switch with connector	R-4
<b>ZE/ZV/ ZV2</b>	High-capacity switches, 3 mounting styles	R-5
<b>D4MC</b>	Compact enclosed limit switch	R-6
<b>D4E-N</b>	Slim and compact enclosed limit switch with a long life	R-6
<b>SHL</b>	Enclosed limit switch with coil spring action	R-7
<b>VB</b>	Multiple plunger limit switch	R-8
<b>D5B</b>	Tactile switches detect objects from multiple directions	R-8
<b>Basic Switches</b>		
<b>Z</b>	High precision basic switch	R-9
<b>A</b>	High capacity basic switch	R-10
<b>X</b>	Direct Current basic switch	R-11
<b>TZ</b>	High temperature basic switch	R-12
<b>DZ</b>	Basic switch with two independent circuits	R-13

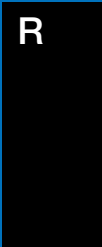



## DOWNSIZE WITHOUT COMPROMISE

### D4C – Compact, flat, high-performing switches





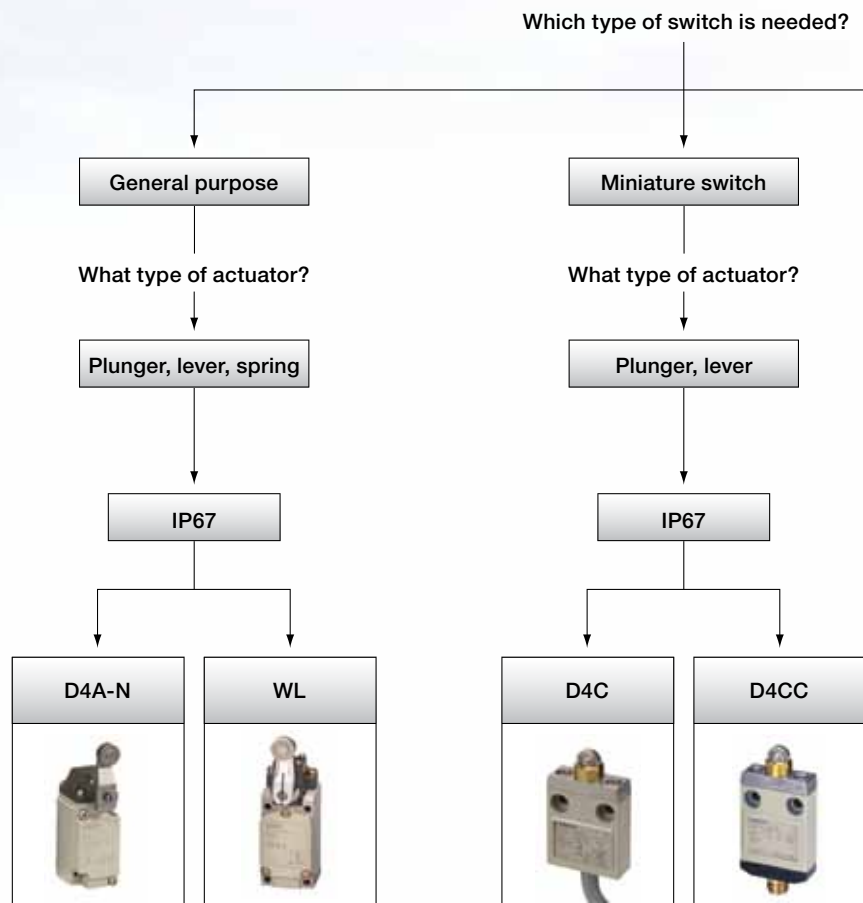

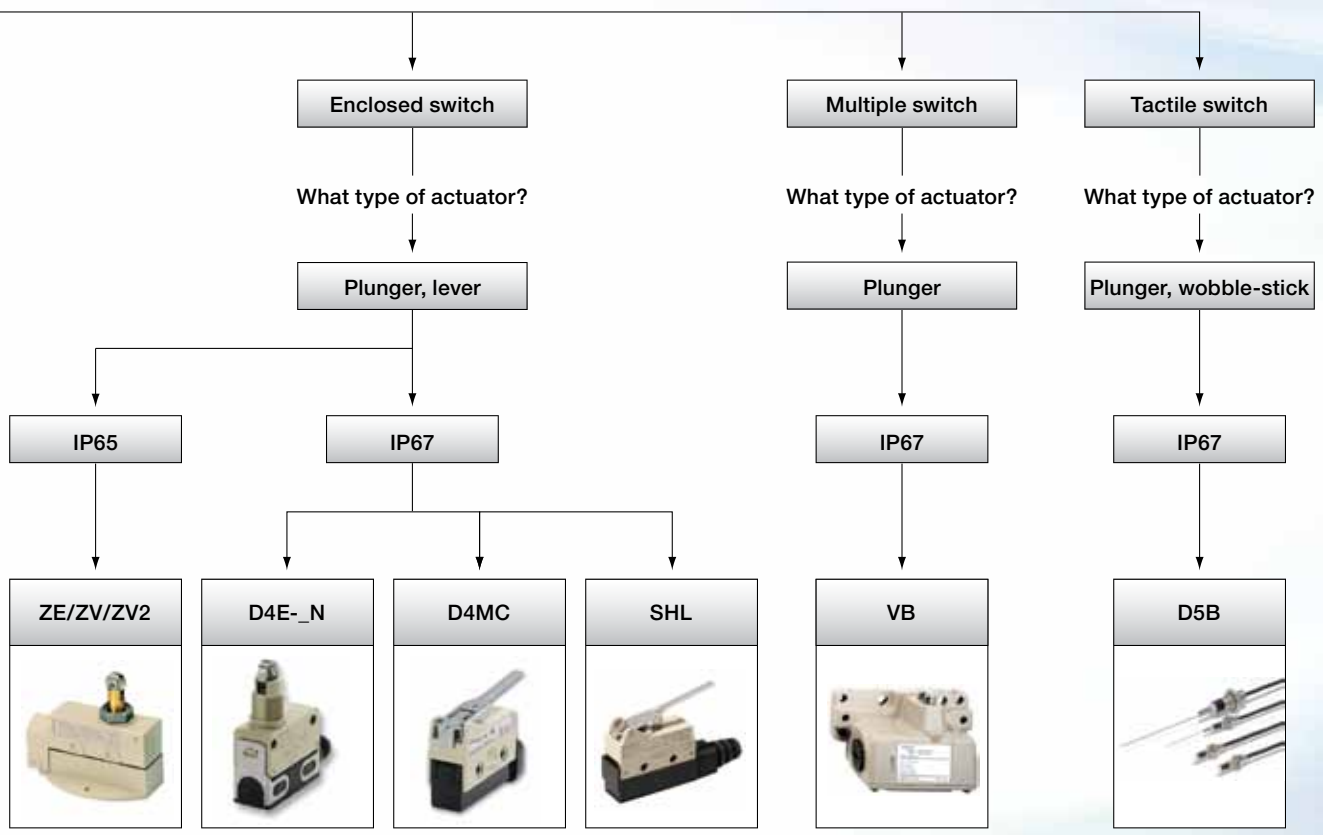





























With only a width of 16 mm, these compact and flat switches let you meet the demand for down-sizing without compromising on specifications. The reliable SPDT contact inside can switch up to 5 A/250 VAC resistive load. A full range of actuators is available to meet all your mechanical requirements.

- Slim, compact body sizes
- Wide range of actuators
- Strong metal housing, triple sealed with IP67 rating
- Pre-wired and quick-to-service connector models









# Selection Table

Type		Two circuit limit switch	Heavy duty limit switch	Enclosed switch, pre-wired	Enclosed switch, connector	High-capacity switch	
							
Selection criteria	Model	WL	D4A-N	D4C	D4CC	ZE/ZV/ZV2	
	Degree of protection	IEC	IP67	IP67	IP67	IP67	IP65
	Contact type	SPDT	■	■	■	■	■
		DPDT	–	■	–	–	–
SPST-NC		–	–	–	–	–	
Features	Switch ratings (Resistive load)	<ul style="list-style-type: none"> <li>• 10 A, 500 VAC</li> <li>• 6 A, 30 VDC</li> <li>• 0.8 A, 125 VDC</li> <li>• 0.4 A, 250 VDC</li> </ul>	<ul style="list-style-type: none"> <li>• 10 A, 480 VAC</li> <li>• 10 A, 14 VDC</li> <li>• 6 A, 30 VDC</li> <li>• 0.8 A, 125 VDC</li> </ul>	<ul style="list-style-type: none"> <li>• 5 A, 250 VAC</li> <li>• 4 A, 30 VDC</li> <li>• 0.4 A, 125 VDC</li> <li>• 0.2 A, 250 VDC</li> </ul>	<ul style="list-style-type: none"> <li>• 1 A, 125 VAC</li> <li>• 1 A, 30 VDC</li> </ul>	<ul style="list-style-type: none"> <li>• 15 A, 250 VAC</li> <li>• 10 A, 480 VAC</li> <li>• 15 A, 30 VDC</li> <li>• 0.5 A, 125 VDC</li> <li>• 0.25 A, 250 VDC</li> </ul>	
	Microload type	■	–	■	–	–	
Actuators	Operation indicator	■	■	■	■	–	
	Adjustable rod lever 	■	■	–	–	–	
	Adjustable roller lever 	■	■	–	–	–	
	Bevel plunger 	■	–	■	■	–	
	Center roller lever 	■	–	■	■	–	
	Coil spring 	■	■	–	–	–	
	Cross roller plunger 	■	–	■	■	■	
	Fork lever lock 	■	■	–	–	–	
	Hinge lever 	■	–	–	–	–	
	Hinge roller lever 	■	–	–	–	–	
	Horizontal roller plunger 	■	■	–	–	–	
	Horizontal ball plunger 	■	■	–	–	–	
	One-way action hinge roller lever 	–	–	–	–	■	
	Panel mount plunger 	–	–	–	–	–	
	Panel mount pin plunger 	–	–	■	■	–	
	Panel mount roller plunger 	–	–	■	■	–	
	Panel mount cross roller plunger 	–	–	–	–	–	
	Pin plunger 	■	–	■	■	–	
	Plastic rod 	■	–	■	■	–	
	Roller lever 	■	■	■	■	■	
	Roller plunger 	■	■	■	■	■	
	Sealed cross roller plunger 	■	–	■	■	■	
	Sealed plunger 	■	–	■	■	■	
	Sealed roller plunger 	■	–	■	■	■	
	Short hinge lever 	–	–	–	–	–	
	Short hinge roller lever 	–	–	–	–	–	
	Side plunger 	■	■	–	–	–	
	Side roller plunger 	■	■	–	–	–	
	Top ball plunger 	■	■	–	–	–	
	Top plunger 	■	■	–	–	–	
	Hemispherical ball 	–	–	–	–	–	
	Cone plunger 	–	–	–	–	–	
	Wire plunger 	–	–	–	–	–	

■ Standard    □ Available    – No/not available

# Limit Switches

Type		Small sealed switch	Enclosed switch	Coil spring action switch	Multiple plunger switch	Tactile switch	
							
Selection criteria	Model	D4E-_N	D4MC	SHL	VB	D5B	
	Degree of protection	IEC IP67	IP67	IP67	IP67	IP67	
	Contact type	SPDT	■	■	■	■	—
		DPDT	—	—	—	■ (Up to 6PDT)	—
SPST-NC		—	—	—	—	■	
Switch ratings (Resistive load)		<ul style="list-style-type: none"> <li>• 5 A, 250 VAC</li> <li>• 5 A, 30 VDC</li> <li>• 0.5 A, 125 VDC</li> <li>• 0.25A, 250 VDC</li> </ul>	<ul style="list-style-type: none"> <li>• 10 A, 250 VAC</li> <li>• 3 A, 480 VAC</li> <li>• 10 A, 14 VDC</li> <li>• 6 A, 30 VDC</li> <li>• 0.5 A, 125 VDC</li> <li>• 0.25 A, 250 VDC</li> </ul>	<ul style="list-style-type: none"> <li>• 10 A, 250 VAC</li> <li>• 2 A, 480 VAC</li> <li>• 10 A, 14 VDC</li> <li>• 0.4 A, 125 VDC</li> <li>• 0.2 A, 250 VDC</li> </ul>	<ul style="list-style-type: none"> <li>• 10 A, 250 VAC</li> <li>• 0.6 A, 125 VDC</li> <li>• 0.3 A, 250 VDC</li> </ul>	<ul style="list-style-type: none"> <li>• 1 mA, 5 VDC</li> <li>• 30 mA, 30 VDC</li> </ul>	
Features	Microload type	■	—	■	■	■	
	Operation indicator	■	—	■	—	—	
Actuators	Adjustable rod lever	—	—	—	—	—	
	Adjustable roller lever	—	—	—	—	—	
	Bevel plunger	—	—	—	■	—	
	Center roller lever	—	—	—	—	—	
	Coil spring	—	—	—	—	—	
	Cross roller plunger	■	—	—	—	—	
	Fork lever lock	—	—	—	—	—	
	Hinge lever	—	■	■	—	—	
	Hinge roller lever	■	■	■	—	—	
	Horizontal roller plunger	■	—	—	—	—	
	Horizontal ball plunger	—	—	—	—	—	
	One-way action hinge roller lever	■	—	■	—	—	
	Panel mount plunger	■	■	■	—	—	
	Panel mount pin plunger	—	—	—	—	—	
	Panel mount roller plunger	■	■	■	—	—	
	Panel mount cross roller plunger	■	■	■	—	—	
	Pin plunger	—	—	—	—	—	
	Plastic rod	—	—	—	—	—	
	Roller lever	■	■	■	—	—	
	Roller plunger	■	—	—	■	—	
	Sealed cross roller plunger	■	—	—	—	—	
	Sealed plunger	■	—	—	—	—	
	Sealed roller plunger	■	—	—	—	—	
	Short hinge lever	—	■	■	—	—	
	Short hinge roller lever	—	■	■	—	—	
	Side plunger	—	—	—	—	—	
	Side roller plunger	—	—	—	—	—	
	Top ball plunger	—	—	—	—	—	
	Top plunger	—	—	—	—	—	
	Hemispherical ball	—	—	—	—	■	
	Cone plunger	—	—	—	—	■	
	Wire plunger	—	—	—	—	■	

■ Standard    □ Available    — No/not available



## GLOBAL STANDARD BASIC SWITCHES

Wide range offering the most standard basic switches

High precision and wide variety of styles meet wide range of applications.

- Long life, high-accuracy and high quality
- A large switching capacity of 15A with high repeat accuracy
- Micro load models available
- Molded terminal-type models available

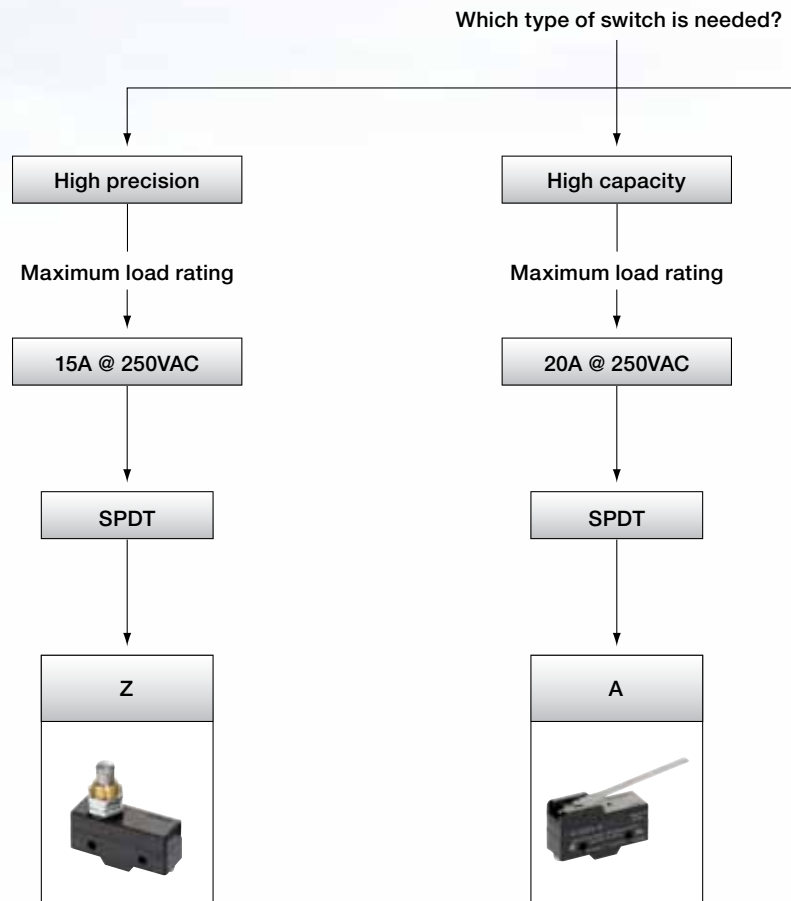

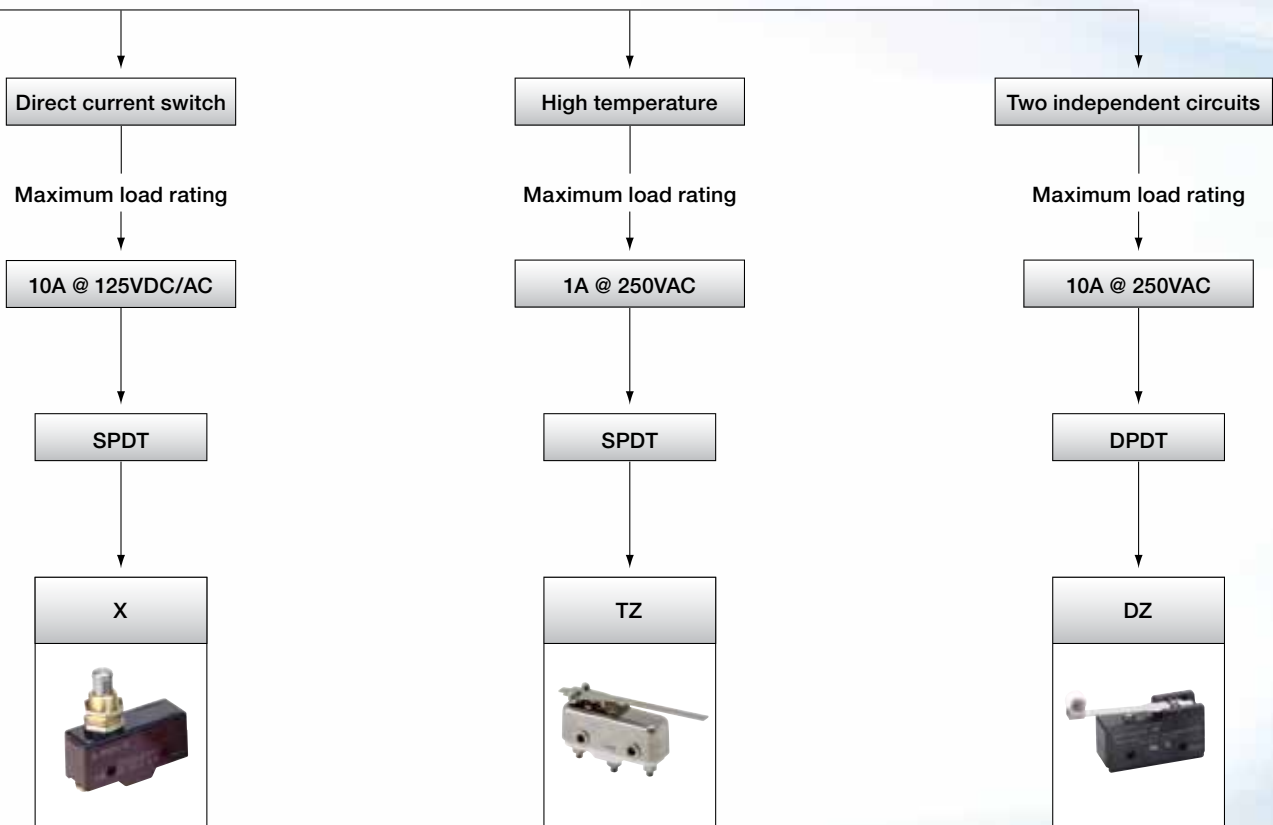

# Selection Table

Type		High precision switch	High capacity switch	Direct Current switch	High-temperature switch	Two independent circuits	
							
Specifications	Model	Z-15G	A-20G	X-10G	TZ-1G	DZ-10G	
	Contact type	SPDT	■	■	■	■	—
		DPDT	—	—	—	—	■
Switch ratings (Resistive load)		<ul style="list-style-type: none"> <li>• 15A @ 250VAC</li> <li>• 6A @ 30VDC</li> <li>• 0.5A @ 125VDC</li> </ul>	<ul style="list-style-type: none"> <li>• 20A @ 250VAC</li> <li>• 6A @ 30VDC</li> <li>• 0.5A @ 125VDC</li> </ul>	<ul style="list-style-type: none"> <li>• 10A @ 125VDC/AC</li> <li>• 3A @ 250VDC/AC</li> </ul>	<ul style="list-style-type: none"> <li>• 1A @ 250VAC</li> <li>• 1A @ 30VDC</li> </ul>	<ul style="list-style-type: none"> <li>• 10A @ 250VAC</li> <li>• 0.5A @ 125VDC</li> </ul>	
Service Life	Mechanical (cycles)	• 20 million	• 1 million	• 1 million	• 100,000	• 1 million	
	Electrical (cycles)	• 500,000	• 500,000	• 100,000	• 50,000	• 500,000	
Actuators	Pin plunger	■	■	■	■	■	
	Slim spring plunger	□	—	□	—	—	
	Short spring plunger	□	□	□	—	—	
	Panel mount plunger	■	■	■	—	—	
	Panel mount roller plunger	■	■	■	—	—	
	Panel mount cross roller plunger	□	□	□	—	—	
	Leaf spring lever	□	—	□	—	—	
	Roller leaf spring lever	□	—	—	—	—	
	Short hinge lever	□	□	□	—	—	
	Hinge lever	■	■	■	■	■	
	Low-force hinge lever	□	—	□	—	—	
	Low-force wire hinge lever	□	—	—	—	—	
	Short hinge roller lever	■	□	■	■	■	
	Short hinge cross roller lever	□	—	—	—	—	
	Hinge roller lever	□	■	□	■	■	
	Hinge cross roller lever	□	—	—	—	—	
	One-way short hinge roller lever	□	—	—	—	—	
Reverse hinge lever	□	—	□	—	—		
Reverse short hinge roller lever	□	—	□	—	—		
Reverse hinge roller lever	□	—	□	—	—		

■ Standard    □ Available    — No/not available

## Robust Single-Pole/Double Break Switches with Built-In Actuators

- Rugged die-cast aluminum housing with high mechanical strength
- Rated IP67 with waterproof, oil-tight and dust-proof construction
- Easy to install and maintain
- Wide range of actuators:
  - Roller levers: Short, medium, long; flush mounting; flange mounting
  - Adjustable levers: Roller lever, rod lever
  - Fork roller levers
  - Plungers: Plain top, top roller, top ball, plain side, side roller, side ball
  - Wobble levers: Steel wire, nylon rod, coil spring
- Wide variety of standard, high-precision and overtravel models
- LED or neon lamp status indicator models available



## Specifications

- Load rating: 10 A max. at 125 VAC, NEMA A600
- Contact configuration: SPDT double break
- Mechanical life: 15 million operations
- High temperature, low temperature, corrosion proof, hermetic, anti-coolant, spatter resistant types available
- Micro-load and “Long-Life” types available
- Class 1 protection against electric shock
- Connection: 1/2-14 NPT conduit entrance, terminal screw connections
- Enclosure rating: IP67; NEMA 3, 4, and 13

Type	Basic	High sensitivity overtravel	90-degree	High-precision overtravel
Action				
Features	<ul style="list-style-type: none"> <li>•Used with roller levers</li> </ul>	<ul style="list-style-type: none"> <li>•Operation is highly sensitive with only 10° pretravel</li> <li>•Overtravel is large, making setting the dog easier</li> <li>•Mounting is compatible with basic models</li> </ul>	<ul style="list-style-type: none"> <li>•Overtravel is large, making setting the dog easier</li> <li>•Mounting is compatible with basic models</li> </ul>	<ul style="list-style-type: none"> <li>•Repeat accuracy is twice that of basic models</li> <li>•Operation is highly sensitive with only 5° pretravel</li> <li>•Ideal for positioning, e.g., with machine tools</li> </ul>
One-way operation	Possible	Not possible	Not possible	Not possible
Head mounting	Any of 4 directions	Any of 4 directions	Any of 4 directions	Any of 4 directions



## Heavy-Duty SPDT and DPDT Switches with Plug-In Construction

- Oil-tight, watertight construction with double seal on the head, a complete gasket cover
- Plug-in construction reduces downtime for maintenance
- Convenient front mounting simplifies installation
- User-selectable operating direction for side rotary switches—CW, CCW, or both
- Position and lock the operating head at any of four 90° positions
- Wide operating temperature range: -40° to 100° C (side rotary)
- Side rotary switches accept a wide selection of levers
- DPDT, double-break models available for sequential operation and center neutral switching



## Specifications

- Load rating: SPDT double break: 10 A max. at 125 VAC, NEMA A600
  - DPDT double break: 5 A max. at 125 VAC, NEMA B600
- Mechanical life:
  - SPDT double break: 50 million operations
  - DPDT double break: 30 million operations
- Connection: 1/2-14 NPT conduit entrance, terminal screw connections
- Enclosure rating: IP67; UL NEMA 3, 4, 4X, 6P, 12 and 13
- Class I protection against electrical shock
- Wide range of actuators:
  - Roller lever: Standard, high-sensitivity, low torque, maintained, sequential operation, center neutral operation
  - Adjustable lever: Side plunger, top plunger
  - Wobble lever: Spring wire, plastic rod, cat whisker, coil spring

## Sealed, Compact, Slim Pre-Wired Limit Switch

- Rugged die-cast aluminum housing
- Rated IP67; triple-sealed construction
- Designed for easy gang mounting
- Standard cable offers high flexibility, outstanding oil and extreme temperature resistance
- Wide range of actuators:
  - Plunger: Pin, roller, cross roller, bevel
  - Sealed plunger: Pin, roller, cross roller
  - Panel mount plunger: Pin, roller, cross roller
  - Roller lever: Standard, center mount
  - Plastic rod
- Gang mount up to 6 switches



## Specifications

- Load rating: SPDT: 5 A max. at 250 VAC, NEMA B300
- Mechanical life: 10 million operations
- Connection: Pre-wired with 3 or 5 cable
- Enclosure rating: IP67; UL NEMA 3, 4 and 13
- Micro load versions available
- Weather-resistant models available

## Sealed, Compact, Slim Limit Switch with Connector

- Center roller lever models enable ganged mounting of up to 6 switches
- M12 4-pin connector reduces installation and maintenance time
- Rated IP67; triple-sealed construction for plungers provides oil-tight and water-tight protection
- AC and DC switching models
- Wide range of actuators:
  - Plunger: Pin, roller, cross roller, bevel
  - Sealed plunger: Pin, roller, cross roller
  - Panel mount plunger: pin, roller, cross roller
  - Roller lever: Low operating force, center mounted
  - Plastic rod
- Micro-Change® connector cordsets available separately



## Specifications

- Load rating: SPDT, 1 A max. at 125 VAC, NEMA D150 or 1 A max. at 30 VDC
- Mechanical life: 10 million operations
- Connection: M12 single keyway 4-pin connector
- Enclosure rating: IP67; UL NEMA 3, 4 and 13

## High-Capacity Switches

- Large 15-amp, 125 VAC switching capacity and long service life
- Wide range of actuators:
  - Plunger: Pin, roller, cross roller
  - Roller arm lever: Standard and sealed
  - Sealed plunger: Pin, roller, cross roller
- Rugged die-cast aluminum housing
- Sealed switches rated IP65 (ZE-N)
- Three mounting styles available:
  - Side mounting (ZE)
  - Diagonal side mounting (ZV2) is ideal for gang mounting several switches
  - Flanged base mounting (ZV)



## Specifications

- Load rating: SPDT, 15 A max. at 125 VAC, NEMA B300 or 1 A max. at 30 VDC
- Mechanical life: 10 million operations
- Connection: Screw terminals on internal switch face forward when the cover is opened
- Enclosure rating: IP65 (ZE-N); IP60 (ZE-Q)
- Micro load version available

## Compact Enclosed Limit Switch

- Suitable for applications demanding higher mechanical strength, dustproof and drip-proof properties
- Rated IP67; gasket diaphragm seal provides high environmental resistance
- High-precision and long life (10,000,000 mechanical operations)
- Wide range of actuators:
  - Panel mount plunger, roller plunger, cross roller plunger
  - Short and standard hinge lever
  - Standard, short and one-way action short hinge roller lever
- Screw terminals or pre-wired with 1 m cable



## Specifications

- Control output: SPDT (form C), rated 10 A max. at 125 VAC (inductive load)
- NEMA A300 rated
- Dimensions: 44.8 H x 21.7 W x 50 D mm (switch body with boot)

## Slim and Compact Enclosed Limit Switch with a Long Life

- Ideal for gang mounting
- Rated IP67; NEMA 3, 4 and 13
- Long service life (10,000,000 mechanical operations)
- Wide range of actuators:
  - Plunger, roller plunger, cross roller plunger
  - Sealed plunger, roller plunger, cross roller plunger
  - Standard and one-way action roller lever
- Screw terminals, connector or pre-wired with 1 m cable models
- Micro-load types available



## Specifications

- Control output: SPDT (form C), rated 5 A max. at 125 VAC (inductive load)
- NEMA A300 rated
- Dimensions: 32.9 H x 18 W x 43 D mm (switch body)

## Enclosed Limit Switch with Coil Spring Action

- Coil spring mechanism extends life of the switch
- Rated IP67; rigid zinc die-cast alloy housing
- Long service life (10,000,000 mechanical operations)
- Wide range of actuators:
  - Plunger panel mount plunger, roller plunger, cross roller plunger
  - Standard and short hinge lever
  - Standard and short hinge roller lever
  - One-way action standard and short hinge roller lever
- Screw terminals or pre-wired with cable models
- Molded terminal and indicator models available



## Specifications

- Control output: SPDT (form C), rated 10 A max. at 125 VAC (inductive load)
- Microload types rated @ 0.1 A
- UL & NEMA A300 rated
- Dimensions: 32.9 H x 17.5 W x 45.6 D mm (switch body)

## Multiple Plunger Limit Switch

- Multiple plunger switches are ideal for machine tools and sequential control
- Robust solution offers 2 to 6 switches in one enclosure
- Easy to install and service; switch box has an oil drain
- Rated IP67; rugged die-cast aluminum housing
- Ground terminal models have EN/IEC approval (CE marking)
- Long service life (5,000,000 mechanical operations)
- Roller plunger or bevel plunger actuators
- G1/2 conduit entrance; screw terminals



## Specifications

- Control output: SPDT (form C), rated 10 A max. at 125 VAC (resistive load)
- Microload types rated @ 0.1 A

- Dimensions: 68 H x 85 W x 58 D mm (2 switch model)
- 106 D mm (6 switch model)

# D5B Limit Switches

## Tactile Switches Detect Objects from Multiple Directions

- Detects object contact and operates even with a slight force
- Gold-plated contacts provide high contact reliability
- Switches micro current/voltage loads
- Long service life (10 million mechanical operations)
- Rated IP67 for resistance to dust, fine particles and water or oil splash
- Three sizes (M10, M8, and M5) to match total travel and operating force requirements
- Three actuator types: hemispheric, cone-shaped, and wobble-stick type
- Pre-wired with 1, 3 or 5 m cable



## Specifications

- Control output: Normally closed; 1 mA at 5 VDC to 30 mA max. at 30 VDC (resistive load)
- Dimensions: M5 x 24.5 L mm (hemispheric); 27 L mm (cone-shaped); 64.1 L mm (wobble stick)

- M8 x 28 L mm (hemispheric); 32.5 L mm (cone-shaped); 92.8 L mm (wobble stick)
- M10 x 33.3 L mm (hemispheric); 39.3 L mm (cone-shaped)
- 111.1 L mm (wobble stick)

# Z Basic Switches

## General-Purpose Limit Switches

Quick Link  
L862

### Best-selling Basic Switch Boasting High Precision and Wide Variety

- Long life with high-accuracy and high quality
- A large switching capacity of 15A with high repeat accuracy
- A wide range of variations in contact form available: basic, split-contact, and maintained-contact
- Micro load models available
- Molded terminal-type models incorporate a finger protection safety terminal cover



### Specifications

- Switch rating: 15 A, 250 VAC
- Contact form: SPDT
- Ambient operating temperature: -25°C to +80°C (with no icing)
- Ambient operating humidity: 35%RH to 85%RH
- Electrical operating frequency: 20 operations/minute maximum
- Electrical service life: 500,000 operations minimum

Actuator	Dimensions H x W x D mm	Rating	Contact form	Mounting hole size	Terminal type	Model
Pin plunger	30 X 49.2 X 17.45	15 A, 250 VAC 10 A, 500 VAC 0.5 A, 125 VDC 0.25 A, 250 VDC	SPDT	4.2 mm	Screw terminal Size : M4	Z-15G-B
					Screw terminal Size : #6-32NC	Z-15G-B7-K
Panel mount plunger	48.3 X 49.2 X 17.45				Screw terminal Size : M4	Z-15GQ-B
Panel mount roller plunger	62.3 X 49.2 X 17.45					Z-15GQ22-B
Hinge lever	38 X 49.2 X 17.45					Z-15GW-B
Short hinge roller lever	42.5 X 49.2 X 17.45					Z-15GW22-B

R



# A Basic Switches

## General-Purpose Basic Switches



### High-capacity Switch Handles 20 A Loads with Large Inrush Currents

- Long life with high-accuracy and high quality
- Directly switches loads such as motors, halogen lamps and solenoids
- Same shape as Omron snap action switch model Z except pin plunger position, yet endures inrush currents as large as 75 A



### Specifications

- Switch Rating: 20 A, 250 VAC
- Contact form: SPDT
- Ambient operating temperature: -25°C to +80°C (with no icing)
- Ambient operating humidity: 35%RH to 85%RH
- Electrical operating frequency: 20 operations/minute maximum
- Electrical service life: 500,000 operations minimum

Actuator	Dimensions H x W x D mm	Rating	Contact form	Mounting hole size	Terminal type	Model
Pin plunger	30 X 49.2 X 17.45	20 A, 250 VAC 15 A, 500 VAC 0.5 A, 125 VDC 0.25 A, 250 VDC	SPDT	4.2 mm	Screw terminal Size : M4	A-20G-B
				3.56 mm	Screw terminal Size : #6-32NC	A-20G-B7-K
Panel mount plunger	48.3 X 49.2 X 17.45			4.2 mm	Screw terminal Size : M4	A-20GQ-B
Panel mount roller plunger	62.3 X 49.2 X 17.45					A-20GQ22-B
Hinge lever	49 X 49.2 X 17.45					A-20GV-B
Hinge roller lever	57 X 49.2 X 17.45					A-20GV2-B

# X Basic Switches

## General-Purpose Basic Switches

Quick Link

L864

### Direct Current Switch with Built-in Magnetic Blowout

- Can be used for either load rating of DC or AC for wide variety of applications
- Incorporates a small permanent magnet in the contact mechanism to deflect the arc to effectively extinguish it
- Ideal for switching DC circuits
- Wide variety of actuators for a wide scope of applications
- Same shape and mounting procedures as Omron's Model Z snap action switches.



### Specifications

- Switch Rating: 10 A, 125 VAC
- Contact form: SPDT
- Ambient operating temperature: -25°C to +80°C (with no icing)
- Ambient operating humidity: 35%RH to 85%RH
- Electrical operating frequency: 20 operations/minute maximum
- Electrical service life: 100,000 operations minimum

Actuator	Dimensions H x W x D mm	Rating	Contact form	Mounting hole size	Terminal type	Model
Pin plunger	30 X 49.2 X 17.45	10 A, 125 VDC/AC 3 A, 250 VDC/AC	SPDT	4.2	Screw terminal Size : M4	X-10G-B
Panel mount roller plunger	54 X 49.2 X 17.45					X-10GQ-B
Hinge lever	65 X 49.2 X 17.45					X-10GQ22-B
Short hinge roller lever	49 X 49.2 X 17.45					X-10GW-B
Hinge roller lever	52 X 49.2 X 17.45					X-10GW22-B

R

### High-temperature Basic Switch for Extreme Applications

- Stable operation at an ambient temperature of 400°C
- Carefully chosen materials ensure high contact reliability at high ambient temperature:
  - Ceramic insulator
  - Cobalt-alloy spring
  - Special alloy contact



### Specifications

- Switch Rating: 1 A, 250 VAC
- Contact form: SPDT
- Ambient operating temperature: -65°C to +400°C (with no icing)
- Ambient operating humidity: 35%RH to 85%RH
- Electrical operating frequency: 20 operations/minute maximum
- Electrical service life: 50,000 operations minimum

Actuator	Dimensions H x W x D mm	Rating	Contact form	Mounting hole size	Terminal type	Model
Pin plunger	25.5 X 49.2 X 17.45	1 A, 250 VAC 1 A, 30 VDC 0.4 A, 125 VDC	SPDT	3.56 mm	Screw terminal Size : M3.5	TZ-1G
Short hinge roller lever	54.5 X 49.2 X 17.45					TZ-1GV
Hinge roller lever	47.9 X 49.2 X 17.45					TZ-1GV22
Hinge lever	49 X 49.2 X 17.45					TZ-1GV2

# DZ Basic Switches

## General-Purpose Basic Switches



### DPDT Basic Switch for Two Independent Circuit Control

- Compact DPDT contacts for size restricted applications
- Incorporates two completely independent built-in switches
- Ideal for switching the circuits operating on two different voltages, and for controlling two independent circuits
- Interchangeable with Omron Z Basic Switches, as both switches are identical in mounting hole dimensions, mounting pitch and pin plunger position



### Specifications

- Switch Rating: 10 A, 250 VAC
- Contact form: DPDT
- Ambient operating temperature: -25°C to +80°C (with no icing)
- Ambient operating humidity: 35%RH to 85%RH
- Electrical operating frequency: 20 operations/minute maximum
- Electrical service life: 500,000 operations minimum

Actuator	Dimensions H x W x D mm	Rating	Contact form	Mounting hole size	Terminal type	Model
Pin plunger	25.5 X 49.2 X 17.45	10 A, 250 VAC	DPDT	4.2 mm	Screw terminal Size : M3	DZ-10G-1B
Hinge roller lever	41.6 X 49.2 X 17.45	10 A, 30 VDC				DZ-10GV2-1B
Hinge lever	54.5 X 49.2 X 17.45	0.5 A, 125 VDC				DZ-10GW-1B
Short hinge roller lever	47.9 X 49.2 X 17.45	0.25 A, 250 VDC				DZ-10GW22-1B

R

# Limit and Basic Switches

---

## Contents

<b>Selection Guide</b>		S-ii
<b>Digital Timers</b>		
<b>H5CX-N</b>	Digital multi-function timers, 1/16 DIN	S-1
<b>H3CA</b>	Digital-set timer with LCD bar graph display, 1/16 DIN	S-2
<b>Analog Timers</b>		
<b>H3CR</b>	Analog-set multi-function timers, 1/16 DIN	S-3
<b>H3YN</b>	Compact, socket mount, analog-set relay timers with multiple operating modes	S-4
<b>H3JA</b>	Economical, compact, plug-in timer, 36 x 36 mm	S-4
<b>H3DK</b>	Slim 22.5 mm track-mount analog-set timers	S-5
<b>H3DS</b>	Slim 17.5 mm track-mount analog-set timers	S-6
<b>Time Switches</b>		
<b>H5S</b>	Weekly and yearly timers with AM/PM display	S-7
<b>H5L</b>	Digital weekly time switch with large display	S-8
<b>H5F</b>	Digital daily time control with simple operations	S-8

## WHEN TIMING ACCURACY MATTERS!

### H5CX-N – The most complete digital timer

The H5CX-N series offers multiple functions and timing ranges for precise timing control, as well as real twin-timing and memory function. These and other added-value features ensure that the H5CX-N covers almost every possible user requirement in timers.



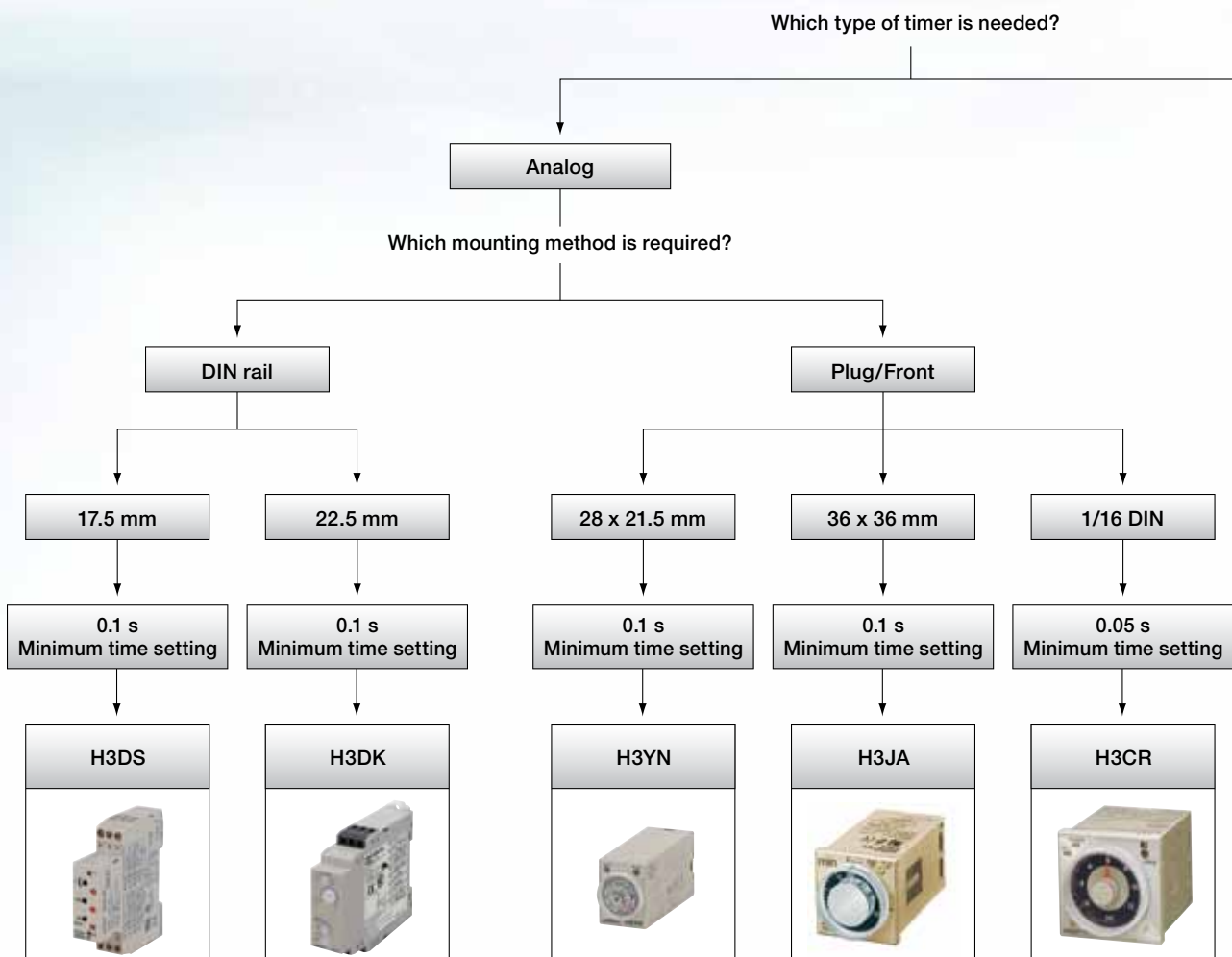

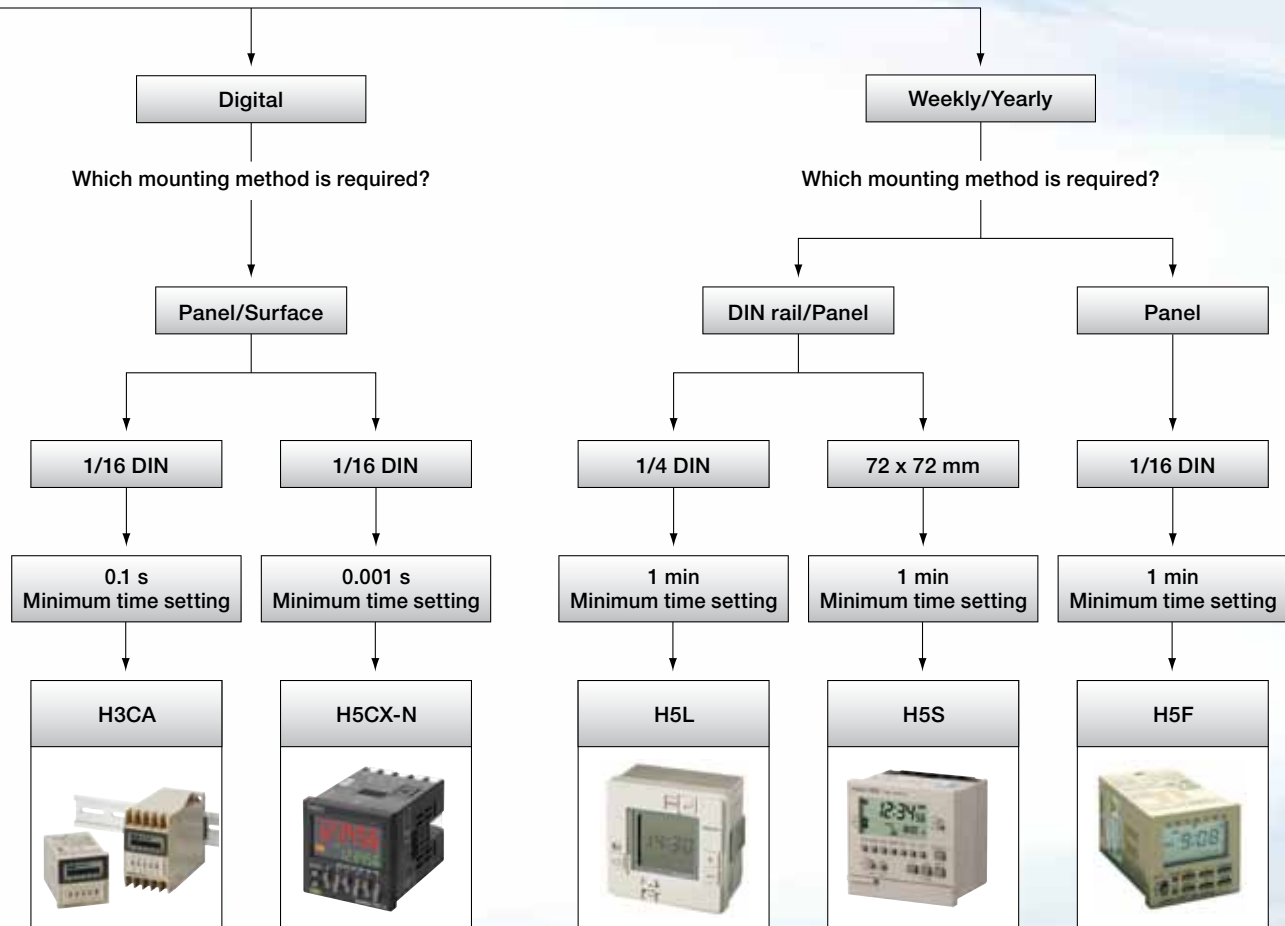
- 15 different time functions
- Three color display value: Red, orange or green
- Models with instantaneous contact outputs
- 0.001 s to 9999 h, 10 ranges









# Selection Table





Category		Analog Solid State Timer				
						
Selection criteria	Model	H3DS-M	H3DS-S	H3DS-A	H3DS-F	
	Mounting	DIN-rail				
	Width	17.5 mm				
	Type	Multi-functional		ON-delay (fixed)	Twin timer	
Contact configuration	Time limit	■	■	■	■	
	Instantaneous	—	—	—	—	
	Programmable contacts	—	—	—	—	
	14 pins	—	—	—	—	
	11 pins	—	—	—	—	
	8 pins	—	—	—	—	
	Screw terminals	■	■	■	■	
Inputs	Screw-less clamp terminals	□	□	□	□	
	Screw-less clamp sockets	—	—	—	—	
	Voltage input	□	□	□	—	
Outputs	Transistor	—	—	—	—	
	Relay	■	■	■	■	
	SCR	—	—	—	—	
	Relay output type	SPDT	■	■	■	■
		SPST-NO	—	—	—	—
		DPDT	—	—	—	—
4PDT		—	—	—	—	
Features	Time range	0.1 s to 120 h	1 s to 120 h	2 s to 120 h	0.1 s to 12 h	
	Number of sub ranges	7	7	7	6	
	Supply voltage	24 to 230 VAC, or 24 to 48 VDC	24 to 230 VAC, or 24 to 48 VDC	24 to 230 VAC, or 24 to 48 VDC	24 to 230 VAC, or 24 to 48 VDC	
	Number of operating modes	8	4	1	2	
Functions	ON-delay	■	■	—	—	
	Flicker OFF start	■	—	—	■	
	Flicker ON start	■	■	—	■	
	Signal ON-/OFF-delay	■	—	—	—	
	Signal OFF-delay	■	—	—	—	
	Interval (signal or power start)	■	■	—	—	
	One-shot output (ON-delay)	■	■	—	—	
	ON-delay (fixed)	—	—	■	—	
	Independent ON/OFF time setting	—	—	—	—	
Star-delta	—	—	—	—		
Re-remarks	Transistor	—	—	—	—	

■ Standard    □ Available    — No/not available





Category		Analog Solid State Timer				
						
Selection criteria	Model	H3DK-M	H3DK-S	H3DK-F	H3DK-H	
	Mounting	DIN-rail				
	Width	22.5 mm				
	Type	Multi-functional		Twin timer	Power OFF-delay	
Contact configuration	Time limit	■	■	■	■	
	Instantaneous	■	■	—	■	
	Programmable contacts	■	■	—	—	
	14 pins	—	—	—	—	
	11 pins	—	—	—	—	
	8 pins	—	—	—	—	
	Screw terminals	■	■	■	■	
	Screw-less clamp terminals	—	—	—	—	
Screw-less clamp sockets	—	—	—	—		
Inputs	Voltage input	■	—	—	—	
Outputs	Transistor	—	—	—	—	
	Relay	■	■	■	■	
	SCR	—	—	—	—	
	Relay output type	SPDT	■	■	■	■
		SPST-NO	—	—	—	—
		DPDT	□	■	—	—
4PDT		—	—	—	—	
Features	Time range	Total time range	0.1 s to 1200 h	0.1 s to 1200 h	0.1 s to 1200 h	0.1 to 12 s 1.0 to 120 s
		Number of sub ranges	8	8	8	2 (model dependent)
	Supply voltage	24 to 240 VAC/DC, or 12 VDC	24 to 240 VAC/DC, or 12 VDC	24 to 240 VAC/DC, or 12 VDC	100 to 120 VAC, 200 to 240 VAC, or 24 to 48 VAC/DC	
	Number of operating modes	8	4	2	1	
Functions	ON-delay	■	■	—	—	
	Flicker OFF start	■	—	■	—	
	Flicker ON start	■	■	■	—	
	Signal ON-/OFF-delay	■	—	—	—	
	Signal OFF-delay	■	—	—	■	
	Interval (signal or power start)	■	■	—	—	
	One-shot output (ON-delay)	■	■	—	—	
	ON-delay (fixed)	—	—	—	—	
	Independent ON/OFF time setting	—	—	—	—	
	Star-delta	—	—	—	—	
Re-remarks	Transistor	—	—	—	—	

■ Standard □ Available — No/not available

# Selection Table

Category		Analog Solid State Timer					
							
Selection criteria	Model	H3CR-A	H3CR-F	H3CR-H	H3YN	H3JA	
	Mounting	Socket/on panel					
	Width	1/16 DIN	1/16 DIN	1/16 DIN	21.5 x 28 mm	36 x 36 mm	
Contact configuration	Type	Multi-functional	Twin timer	Power OFF-delay	Miniature	Miniature	
	Time limit	■	■	■	■	■	
	Instantaneous	■	—	■	—	—	
	Programmable contacts	—	—	—	—	—	
	14 pins	—	—	—	■	—	
	11 pins	□	■	■	—	—	
	8 pins	□	■	■	■	■	
	Screw terminals	—	—	—	—	—	
	Screw-less clamp terminals	—	—	—	—	—	
Screw-less clamp sockets	—	—	—	□	—		
In-puts	Voltage input	□	—	—	—	—	
	Transistor	□	—	—	—	—	
Outputs	Relay	□	■	■	■	■	
	SCR	—	—	—	—	—	
	Relay output type	SPDT	□	—	□	—	■
		SPST-NO	—	—	—	—	—
		DPDT	□	■	□	■	■
		4PDT	—	—	—	■	—
Features	Time range	Total time range	0.05 s to 300 h, 0.1 s to 600 h (model dependent)	0.05 s to 30 h or 1.2 s to 300 h (model dependent)	0.05 s to 12 s, 0.05 to 12 min	0.1 s to 10 h (model dependent)	0.1 s to 3 h
		Number of sub ranges	9	14	4	2	1 range per model, 12 models
	Supply voltage	<ul style="list-style-type: none"> <li>• 100 to 240 VAC</li> <li>• 100 to 125 VDC</li> <li>• 24 to 48 VAC</li> <li>• 12 to 48 VDC</li> </ul>	<ul style="list-style-type: none"> <li>• 100 to 240 VAC</li> <li>• 12 VDC</li> <li>• 24 VAC/DC</li> <li>48 to 125 VDC</li> </ul>	<ul style="list-style-type: none"> <li>• 100 to 120 VAC</li> <li>• 200 to 240 VAC</li> <li>• 48 VDC</li> <li>• 100 to 125 VDC</li> </ul>	<ul style="list-style-type: none"> <li>• 24, 100 to 120, 200 to 230 VAC</li> <li>• 12, 24, 48, 100 to 110, 125 VDC</li> </ul>	<ul style="list-style-type: none"> <li>• 100-120 VAC</li> <li>• 200-240 VAC</li> <li>• 24 VAC</li> <li>• 12 VDC</li> <li>• 24 VDC</li> </ul>	
	No. of operating modes	6 (model dependent)	1	1	4	1	
Functions	ON-delay	□	—	—	■	■	
	Flicker OFF start	□	■	—	■	—	
	Flicker ON start	□	■	—	■	—	
	Signal ON-/OFF-delay	□	—	—	—	—	
	Signal OFF-delay	□	—	■	—	—	
	Interval (signal or power start)	□	—	—	■	—	
	One-shot output (ON-delay)	□	—	—	—	—	
	ON-delay (fixed)	—	—	—	—	—	
	Independent ON/OFF time setting	—	—	—	—	—	
	Star-delta	—	—	—	—	—	
Re-remarks	Transistor	□	—	—	—	—	

■ Standard    □ Available    — No/not available

Category		Digital Timer		Weekly Timer			
							
Selection criteria	Model	H5CX-N	H3CA	H5S	H5L	H5F	
	Mounting	Socket/on panel		DIN rail/panel			
	Width	1/16 DIN	1/16 DIN; 75 x 45 mm	72 x 72 mm	1/4 DIN	1/16 DIN	
	Type	Multi-functional	Multi-functional with LCD bar graph display	Digital weekly and yearly timer	Digital weekly timer with large display	Digital daily timer	
Contact configuration	Time limit	■	■	—	—	—	
	Instantaneous	■	■	—	—	—	
	Programmable contacts	■	—	■	■	■	
	14 pins	—	—	—	—	—	
	11 pins	■	■	—	—	—	
	8 pins	■	■	—	—	—	
	Screw terminals	□	□ H3CA-FA	■	■	■	
	Screw-less clamp terminals	—	—	—	—	—	
	Screw-less clamp sockets	—	—	—	—	—	
In-puts	Voltage input	—	—	—	—	—	
	Transistor	□	—	—	—	—	
Outputs	Relay	□	■	■	■	■	
	SCR	—	—	—	—	—	
	Relay output type	SPDT	□	■	—	—	—
		SPST-NO	—	—	2 @ 15 A weekly or yearly, 4 @ 3 A yearly	2 @ 15 A	1 @ 15 A
		DPDT	—	■	—	—	—
		4PDT	—	—	—	—	—
Features	Time range	Total time range	0.001 s to 9999 h configurable	0.1 s to 9990 h	0.00 to 23.59 h	0.00 to 23.59 h	0.00 to 23.59 h
		Number of sub ranges	10	7	3	1	1
	Supply voltage	• 100 to 240 VAC • 24 VAC • 12 to 24 VDC	• 24 to 240 VAC • 12 to 240 VDC • see datasheet for H3CA-8	• 100 to 240 VAC • 24 VDC	• 100 to 240 VAC	• 100 to 240 VAC	
	No. of operating modes	15	8	—	—	—	
Functions	ON-delay	■	■	—	—	—	
	Flicker OFF start	■	■	—	—	—	
	Flicker ON start	■	■	—	—	—	
	Signal ON-/OFF-delay	■	■	—	—	—	
	Signal OFF-delay	■	■	—	—	—	
	Interval (signal or power start)	■	■	—	—	—	
	One-shot output (ON-delay)	■	■	—	—	—	
	ON-delay (fixed)	■	—	—	—	—	
	Independent ON/OFF time setting	■	—	■	■	■	
Star-delta	—	—	—	—	—		
Re-marks	Transistor	■	—	—	—	—	

■ Standard □ Available — No/not available

# Timers

---

## Space-Saving 1/16 DIN Timer with All-in-one Functionality

Easy-to-set timing and security functions satisfy multiple design needs with a single part, reducing your stock. High accuracy setting and operation in all modes assures reliable performance.

- Short body: Only 59 mm depth for 24 VAC/ VDC models, 78 mm depth for 100-240 VAC models
- Waterproof/dust proof front (UL 508 Type 4X and IP66)
- Isolated inputs and power eliminates unwanted circuit paths
- Built-in output cycle counter supports predictive maintenance
- Green and Orange display shows change in output status



Type	Time specifications	Operating modes	Connection type	Inputs	Output type	Supply voltage	Model
H5CX-A series 4-digit models	0.001 to 9.999 s 0.01 to 99.99 s 0.1 to 999.9 s 1 to 9999 s 1 s to 99 min 59 s 0.1 to 999.9 min 1 to 9999 min 1 min to 99 h 59 min 0.1 to 999.9 h 1 to 9999 h	Timer Mode A: Signal ON Delay I A-1: Signal ON Delay II A-2: Power ON Delay I A-3: Power ON Delay II b: Repeat cycle 1 b-1: Repeat cycle 2 d: Signal OFF Delay E: Interval F: Cumulative Z: ON/OFF-duty-adjustable flicker S: Stopwatch  Twin Timer Mode t-off: Flicker OFF Start 1 t-on: Flicker ON Start 1 t-off-1: Flicker OFF Start 2 t-on-1: Flicker ON Start 2	Screw terminals	Signal, Reset, Gate (NPN/PNP input)	Contact output (time-limit SPDT)	100 to 240 VAC	H5CX-A-N
							12 to 24 VDC/ 24 VAC
			11-pin socket		100 to 240 VAC	H5CX-A11-N	
			11-pin socket	Signal, Reset (NPN input)	12 to 24 VDC/ 24 VAC	H5CX-A11D-N	
H5CX-L series 4-digit models		Twin Timer Mode t-off: Flicker OFF Start 1 t-on: Flicker ON Start 1 t-off-1: Flicker OFF Start 2 t-on-1: Flicker ON Start 2  Timer Mode A-2: Power ON Delay I b: Repeat cycle 1 E: Interval Z: ON/OFF-duty-adjustable flicker  Twin Timer Mode t-off: Flicker OFF Start 1 t-on: Flicker ON Start 1	8-pin socket	None	Contact output (time-limit SPDT + instantaneous SPDT) Models with instantaneous contact outputs	100 to 240 VAC	H5CX-L8-N
							12 to 24 VDC/ 24 VAC
					100 to 240 VAC	H5CX-L8E-N	
					12 to 24 VDC/ 24 VAC	H5CX-L8ED-N	
H5CX-B series 6-digit model	0.01 to 9999.99 s 1 s to 99h 59 min 59 s 0.1 to 99999.9 min 0.1 to 99999.9 h	A: Signal ON Delay I F-1: Cumulative	Screw terminals	Signal, Reset, Gate (NPN/PNP input)	Transistor output (DPST)	12 to 24 VDC	H5CX-BWSD-N

## 1/16 DIN, Digital-Set Timer with LCD Bar Graph Display

- 8 field selectable operation modes or ON-delay only model
- Time remaining LCD bar graph and LCD output indicator
- Easy to install, fits 8- or 11- pin sockets
- Universal AC/DC Supply voltage timer available
- Selectable no-voltage start, reset, gate and check inputs expand capabilities
- Time limit or instantaneous output, select SPDT or DPDT models (3 A @ 250 VAC)
- Panel mounting adapters, sockets and accessories available



## Specifications

- Timing functions: Multi-mode: ON-delay, Repeat cycle, Signal Interval/OFF-delay, Signal-OFF delay (I & II), Interval, Cycle and Signal ON-delay/OFF-delay, ON-delay only
- Timing ranges: 7 ranges: 0.1 seconds to 9990 hours
- Repeat accuracy:  $\pm 0.3\%$  of range,  $\pm 0.05$  second
- Control output: 10 mA to 3 A at 250 VAC

## Solid-State Timers with 8 Selectable Functions

Dimensions H x W x D mm	Supply voltage	Output type	Output rating	Inputs	Input rating	Connection type	Model
48 x 48 x 89	24 to 240 VAC, 50/60 Hz,	Relay	SPDT, 3 A at 250 VAC	Start, Reset, Gate	No-voltage	11-pin socket	H3CA-A
75 x 45 x 101	12 to 240 VDC					Front mounted screw terminals	H3CA-FA

## Solid-State Timers - ON-delay Only

Dimensions H x W x D mm	Supply voltage	Output type	Output rating	Inputs	Input rating	Connection type	Model
48 x 48 x 89	Specify 24 VAC, 100/110/120 VAC, or 200/220/240 VAC, 50/60 Hz	Relay (time limit or instantaneous)	SPDT, 3 A at 250 VAC	Start, Reset, Gate	No-voltage	8-pin socket	H3CA-8H
		Relay					H3CA-8
	Specify 12, 24, 48 or 110 VDC						

## 1/16 DIN Analog-Set Timer

- Use for delay timing, repeatable cycles or duration (interval) timing
- Select 4- or 6-function models to handle most applications
- Repeat cycle models with independent ON and OFF periods available
- Power-OFF delay models available
- 5-amp DPDT relay switches when timing cycle completes
- Short, 80 mm (3.15 inch) panel mounting depth with socket allows space-efficient control panel design



## Ordering Information

### Multi-Mode Timers H3CR-A [Quick Links T323]

Output	Number of pins	Supply voltage	Time range	Operating mode	Model
Relay DPDT	11	100 to 240 VAC/ 100 to 125 VDC	0.05 s to 300 h	ON-delay, repeat OFF start, repeat ON start ON start, signal ON/OFF-delay, signal OFF-delay, interval	H3CR-A 100-240AC/100-125DC
		24 to 48 VAC/ 12 to 48 VDC			H3CR-A 24-48AC/12-48DC
	8	100 to 240 VAC/ 100 to 125 VDC		ON-delay, flicker ON start, interval, one-shot	H3CR-A8 100-240AC/100-125DC
		24 to 48 VAC/12 to 48 VDC			H3CR-A8 24-48AC/12-48DC
		100 to 240 VAC/ 100 to 125 VDC			H3CR-A8E 100-240AC/100-125DC
		24 to 48 VAC/VDC			H3CR-A8E 24-48AC/DC

### Repeat Cycle Timers H3CR-F [Quick Links T336]

Output	Number of pins	Supply voltage	Time range	Operating mode	Model
Relay DPDT	11	100 to 240 VAC	0.05 s to 30 h	Flicker OFF start	H3CR-F 100-240AC
		24 VAC/VDC			H3CR-F 24AC/DC
	8	100 to 240 VAC			H3CR-F8 100-240AC
		24 VAC/VDC			H3CR-F8 24AC/DC

### Power Off Delay Timers [Quick Links T337]

See datasheet.



# H3YN Solid State Timer

Quick Link

T324

## Analog-Set Relay Timers with Multiple Operating Modes

- Space-saving and easy to operate
- Miniature timer offers selectable timing modes
- Seconds/minutes timing range models in stock; minutes/hours models available
- Monitor relay status using independent Power-ON and Time-Up indicators
- Socket-mount timers simplify installation and maintenance
- Sockets, hold-down clips and mounting accessories available separately



### Specifications

- Supply voltage: 100-120 VAC, 200-230 VAC, or 24 VAC, 50/60 Hz; 24 VDC
- Timing functions: ON-delay, Interval and Repeat cycle with OFF-start or ON-start (DIP switch selectable)
- Timing ranges: 4 ranges: 0.1 second to 10 minutes; 0.1 minute to 10 hours
- Repeat accuracy:  $\pm 1\%$  FS max.
- Control output: DPDT, 5 A at 250 VAC (H3YN-2), 4PDT, 5 A at 250 VAC (H3YN-4)

# H3JA Solid State Timer

Quick Link

T327

## Economical, Compact, Plug-in Timer

- ON-delay time limit operation with automatic resetting
- DIN size (36 x 36 mm), fits standard 8-pin socket
- Wide choice of time ranges: 1, 3, 5, 10, 30, 60 seconds/3, 5, 10, 30, 60 minutes/3 hours
- Time-limit 5-amp DPDT contact models stocked; 7-amp SPDT models available
- Dual LEDs indicate power and output status
- Large transparent setting knob
- Surface, flush and DIN track mountable



### Specifications

- Supply voltage: 100-120 VAC, 200-240 VAC, or 24 VAC, 50/60 Hz; 12 VDC or 24 VDC
- Timing functions: ON-delay, time limit; automatic resetting
- Timing ranges: 0.1 to 1 second, 0.3 to 3 seconds, 0.5 to 5 seconds, 1 to 10 seconds, 3 to 30 seconds, 6 to 60 seconds, 0.3 to 3 minutes, 0.5 to 5 minutes,
- Repeat accuracy:  $\pm 2\%$  max.
- Control output: DPDT, 100 mA to 5 A at 125/250 VAC (resistive load)

## DIN 22.5 mm Width Timers, Track-Mount, Analog Set

Space-saving slim track-mount timers easily fit into panel designs. Multi-function models with switch selectable dual time limit and instantaneous outputs satisfy multiple design needs with a single part, reducing your stock.



### Features

- 4- and 8-function models
- All sub-series include models with 12-VDC power supply
- Finger-safe terminal block and captive screws according to EN 50274
- EMC (EN 61812-1) compliance for application in heavy industrial, residential, commercial, or light industrial environments



### Ordering Information

Type	Time specifications	Operating modes	Connection type	Inputs	Output type	Supply voltage	Model	
H3DK-M series 8-mode timer	0.1 to 1.2 s 1 to 12 s 10 to 120 s 1 to 12 min 10 to 120 min 1 to 12 hr 10 to 120 hr 100 to 1,200 hr	Timer Mode A ON Delay B: Repeat cycle OFF start B2: Repeat cycle ON start C: Signal ON/OFF Delay D: Signal OFF Delay E: Interval G: Signal ON/OFF delay J: One-shot output	9 screw terminals	Voltage input	Contact output (DPDT time-limit or SPDT time-limit + instantaneous SPDT), switch selected	24 to 240 VAC/VDC	H3DK-M2	
						12 VDC	H3DK-M2A	
					Contact output (SPDT time-limit)	24 to 240 VAC/VDC	H3DK-M1	
						12 VDC	H3DK-M1A	
						Contact output (DPDT time-limit or SPDT time-limit + instantaneous SPDT), switch selected	24 to 240 VAC/VDC	H3DK-S2
							12 VDC	H3DK-S2A
Contact output (SPDT time-limit)	24 to 240 VAC/VDC	H3DK-S1						
	12 VDC	H3DK-S1A						
H3DK-F Repeat cycle timer		Repeat cycle, ON start, Independent ON and OFF time settings	6 screw terminals	-	Contact output (SPDT time-limit)	24 to 240 VAC/VDC	H3DK-F	
						12 VDC	H3DK-FA	

S

## Ultra-slim 17.5 mm Timers, Track-Mount Analog Set

- Eight operating modes (H3DS-M) and four operating modes (H3DS-S) to cover a wide range of applications
- Offers wide time setting range of 0.10 s to 120 h
- Smart Dial/Selector-Locking Mechanism prevents the dials and selectors on the timer's front panel from being operated without authorization (can only be unlocked and locked with an optional pen-type Lock Key)
- Additional single function models available: Repeat cycle independent ON/OFF, ON-delay, ON-delay timer 2 wire
- Finger protection terminal block prevents shock, meets VDE0106/P100
- High immunity to inverter noise



## Specifications

- Supply voltage: 24 to 230 VAC/24 to 48 VDC
- Timing functions: ON-delay (Signal or Power); Repeat-cycle OFF-start (Signal or Power); Repeat-cycle ON-start (Signal or Power); Signal ON/OFF-delay; Signal OFF-delay; Interval (Signal or Power); Signal ON/OFF-delay; One-shot (Signal or Power)
- Timing ranges: 0.1 to 1.2 s, 1 to 12 s, 0.1 to 1.2 min., 1 to 12 min., 0.1 to 1.2 h, 1 to 12 h, 10 to 120 h
- Repeat accuracy:  $\pm 1\%$  max. of full scale
- Control output: 5 A at 250 VAC/30 VDC (resistive load)

## Weekly and Yearly Timers with AM/PM Display

- Control lighting, HVAC systems and production equipment for energy saving operation
- Independent Day Keys provide easier operation
- Temporary holiday setting function makes it easy to turn OFF output for holidays and non-operating days
- Easy-to-use, prompted programming with test mode for easy program checking
- Automatic or manual operation following power failure
- Field-adjustable ON/OFF, cycle and pulse output
- Battery back-up for memory protection
- 2-circuit models include time counter and total counter functions with alarm indicator
- Compact DIN size 72 x 72 mm
- Protective cover and other accessories available separately



## Ordering Information

Control cycle	Number of outputs	Temperature compensation	Mounting method	Supply voltage	Model
Weekly	2 circuits	N	Flush Mounting	100 to 240 VAC	H5S-WB2
		N		24 VDC	H5S-WB2D
		N	Surface Mounting/Track Mounting	100 to 240 VAC	H5S-WFB2
		N		24 VDC	H5S-WFB2D
Yearly	2 circuits	Y	Flush Mounting	100 to 240 VAC	H5S-YB2-X
		Y		24 VDC	H5S-YB2D-X
		Y	Surface Mounting/Track Mounting	100 to 240 VAC	H5S-YFB2-X
		Y		24 VDC	H5S-YFB2D-X
	4 circuits	Y	Flush Mounting	100 to 240 VAC	H5S-YB4-X
		Y		24 VDC	H5S-YB4D-X
		Y	Surface Mounting/Track Mounting	100 to 240 VAC	H5S-YFB4-X
		Y		24 VDC	H5S-YFB4D-X

# H5L Digital Weekly Time Switch

Quick Link

T334

## 1/4 DIN Size Weekly Timer, Easy Programming and Large Display

- Set programs with just 5 switches
- Twenty-four program steps available
- Two independent 15 A control circuits
- Manual override switch for each output
- 10-year battery backup for memory
- Large, easy-to-read LCD display
- Multiple-day operation
- Designed for track mounting; panel and surface mounting hardware included



## Specifications

- Supply voltage: 100 to 240 VAC
- Timing functions: Weekly timer, 24 hrs x 7 days, ON or OFF programming
- Timing ranges: 00:00 to 23:59 (hours:minutes), 1 minute cycle minimum
- Repeat accuracy:  $\pm 0.01\%$ ,  $\pm 0.05$  s max.
- Control output: 15 A at 250 VAC (resistive load)

# H5F Digital Daily Time Switch

Quick Link

T333

## 1/16 DIN Size Timer with Simple Programming

- Control up to 12 ON/OFF operations per day (24 for pulse output operation) for one independent circuit
- Special holidays can be handled easily with the holiday setting function
- Adjustments for sudden schedule changes can be made easily using output override and automatic return operation
- Operation program can be easily checked with the program check function



## Specifications

- Supply voltage: 100 to 240 VAC
- Timing functions: Daily timer, ON or OFF programming
- Timing ranges: 24 h x 7 days (Operation days can be specified) 1 to 59 s, or 1 to 60 min. Pulse-output operation (Pulse width can be set in units of 1 s from 1 to 59 s and in units of 1 min from 1 to 60 min).
- Repeat accuracy:  $\pm 0.01\%$ ,  $\pm 0.05$  s max.
- Control output: Contact output: SPST-NO, 15 A at 250 VAC, resistive load. 10 A at 24 VDC, resistive load. Minimum applied load: 100 mA at 5 VDC (failure level: P, reference value).

- Enables pulse output operation and summer time setting
- Incorporates finger-safe terminals
- Flush, surface, and DIN track mounting options

## Contents

<b>Selection Guide</b>		T-ii
<b>H7CX-N</b>	Advanced 1/16 DIN size preset counters	T-1
<b>H7EC/ H7ET/ H7ER</b>	Subminiature totalizer, time counter, LCD tachometer	T-2
<b>H7BX</b>	72 x 72 mm multi-function counter with a bright, easy-to-view, negative transmissive LCD	T-3
<b>H7CN</b>	1/16 DIN, single preset counter with four-digit LED Display	T-3

## MULTI-FUNCTIONAL PRESET COUNTER



### H7CX-N – Designed with value-added features

The H7CX-N series offers the ultimate in versatility and intuitive programming.

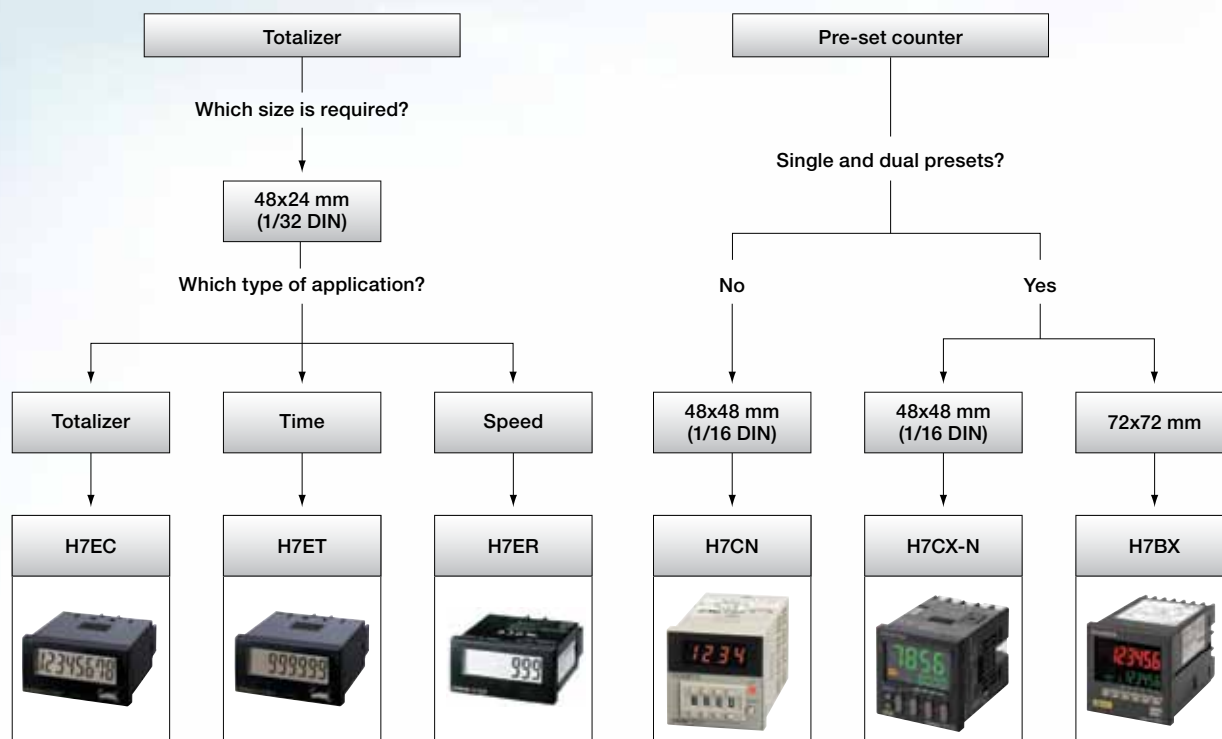
- 7 basic functions in one
- Choose green, orange, or red color for present value
- Twin counter mode
- Character height 12 mm for 4 digit and 10 mm for 6 digit models
- Display 6 digits from -100 K +1 up to 1 M -1



# Selection Table



Category		Self-powered Count Totalizer	Self-powered Time Totalizer	Self-powered Tachometer
				
Selection criteria	Model	H7EC	H7ET	H7ER
	Display	LCD		
	Size	1/32 DIN		
Outputs	Control outputs	–	–	–
	5 stage	–	–	–
	Total	■	–	–
	Time	–	■	–
	Preset	–	–	–
	Batch	–	–	–
	Dual	–	–	–
	Tachometer	–	–	■
Inputs	Control inputs	<ul style="list-style-type: none"> <li>• No-voltage</li> <li>• PNP/NPN</li> <li>• DC-voltage</li> <li>• AC/DC multi-voltage</li> </ul>	<ul style="list-style-type: none"> <li>• No-voltage</li> <li>• PNP/NPN</li> <li>• DC-voltage</li> <li>• AC/DC multi-voltage</li> </ul>	<ul style="list-style-type: none"> <li>• No-voltage</li> <li>• PNP/NPN</li> <li>• DC-voltage</li> </ul>
	Dual operation	–	–	–
Features	Number of digits	8	7	4 or 5
	NPN/PNP switch	–	–	–
	Back-lit	□	□	□
	External reset	■	■	–
	Manual reset	■	■	–
	Number of banks	–	–	–
	Built-in sensor power supply	–	–	–
	IP rating (front face)	IP66/NEMA 4	IP66/NEMA 4	IP66/NEMA 4
Terminals	Screw Terminals	■	■	■
	8-pin socket	–	–	–
	11-pin socket	–	–	–
Supply voltage	100 to 240 VAC	–	–	–
	24 VAC, 12-24 VDC	–	–	–
	24 VDC	□	□	□
	12 to 48 VDC	–	–	–
Functions	Up	■	■	■
	Down	–	–	–
	Up/down	–	–	–
	Reversible	–	–	–
	Speed	20 Hz or switchable 30 Hz / 1 kHz	–	1 or 10 kHz
	Counting range	0 to 99999999	0.0 h to 999999.9 h <--> 0.0 h to 3999 d 23.9 h or 0 s to 999 h 59 min 59 s <--> 0.0 min to 9999 h 59.9 min	1000 s <sup>-1</sup> or 1000 min <sup>-1</sup> ; 1000 s <sup>-1</sup> or 1000 min <sup>-1</sup> <--> 10000 min <sup>-1</sup>
Color	Beige	□	□	□
	Black	■	■	■

■ Standard    □ Available    – No/not available





# Counters

Counter Type		Pre-set Counter	Multi-function	Multi-function
				
Selection criteria	Model	H7CN	H7CX-N	H7BX
	Display	LED	LCD negative transmissive	LCD negative transmissive
	Size	1/16 DIN	1/16 DIN	72 x 72 mm
Outputs	Control outputs	Relay (SPST-NO or SPDT) or solid state open-collector	1 relay (SPDT), transistor	Contact and NPN transistor
	5 stage	–	■	■
	Total	■	■	■
	Time	–	–	■
	Preset	■	■	■
	Batch	–	■	■
	Dual	–	■	■
	Tachometer	–	■	■
Inputs	Control inputs	See datasheet regarding inputs	• No-voltage • PNP/NPN	• No-voltage • PNP/NPN
	Dual operation	–	■	■
Features	Number of digits	PV: 4, SV: 4	PV: 4, SV: 4 or PV: 6, SV: 6	PV: 6, SV: 6
	NPN/PNP switch	–	■	■
	Back-lit	–	■	■
	External reset	■	■	■
	Manual reset	■	■	8 (16- and 32-output models only)
	Memory backup	EEPROM	10 year data storage	10 year data storage
	Built-in sensor power supply	–	–	–
	IP rating (front face)	–	IP66/NEMA 4	IP54
Terminals	Screw Terminals	–	■	■
	8-pin socket	■	–	–
	11-pin socket	■	■	–
Supply voltage	100 to 240 VAC	■	■	■
	24 VAC, 12-24 VDC	–	■	■
	24 VDC	–	–	–
	12 to 48 VDC	■	–	–
Functions	Up	■	■	■
	Down	■	■	■
	Up/down	–	■	■
	Reversible	■	■	–
	Speed	0.01 to 30 Hz or 0.01 to 5 kHz	0.01 to 30 Hz or 0.01 to 5 kHz	0.01 to 30 Hz or 0.01 to 5 kHz
	Counting range	0 to 9999	–99999 to 999999	–99999 to 999999
Color	Beige	■	–	–
	Black	–	■	■

■ Standard    □ Available    – No/not available

## Advanced 1/16 DIN Size Preset Counters

- Space-saving counter solves most counting and positioning applications.
- Small and flexible: Only 59 mm depth (24 VAC/VDC) or 78 mm depth (100-240 VAC)
- Waterproof, dust-proof front panel (UL508 Type 4X and IP66)
- High visibility character height of 12 mm for 4 digit models and 10 mm for 6 digit models
- Built-in Tachometer functions: Protect settings with 5 levels of key access
  - One-input measurement
  - Independent measurement for 2 inputs
  - Differential input for 2 inputs



- Absolute ratio for 2 inputs
- Error ratio between 2 inputs
- Isolated power supply and input circuits prevent unwanted circuit paths
- Built-in output counter supports preventive maintenance
- Switchable display colors show output status changes at a glance

## Ordering Information

Classification	Counting action	Settings	Display digits	Output	Supply voltage	Model
Preset counter	1-stage preset counter Total and preset counter	1-stage	4 digits	Contact output (SPDT)	100 to 240 VAC	H7CX-A114-N
			6 digits		12 to 24 VDC/24 VAC	H7CX-A114D1-N
			4 digits		100 to 240 VAC	H7CX-A11-N
					12 to 24 VDC/24 VAC	H7CX-A11D1-N
			6 digits		100 to 240 VAC	H7CX-A4-N
					12 to 24 VDC/24 VAC	H7CX-A4D-N
			100 to 240 VAC		H7CX-A-N	
12 to 24 VDC/24 VAC	H7CX-AD-N					
Preset counter/ Tachometer	1-stage preset counter 2-stage preset counter Total and preset counter Batch counter Dual counter Twin counter	2-stage	4 digits	Contact output (SPST + SPDT)	100 to 240 VAC	H7CX-A4W-N
			6 digits			
	12 to 24 VDC/24 VAC				H7CX-AWD1-N	
	Contact (SPDT) Transistor (SPST)				100 to 240 VAC	H7CX-AU-N
	12 to 24 VDC/24 VAC		H7CX-AUD1-N			
Tachometer	Tachometer	1-stage (1 input and output)	Contact output (SPDT)	100 to 240 VAC	H7CX-R11-N	
				12 to 24 VDC/24 VAC	H7CX-R11D1-N	
		1-stage (2 inputs and outputs)		100 to 240 VAC	H7CX-R11W-N	
				12 to 24 VDC/24 VAC	H7CX-R11WD1-N	

## Subminiature Totalizer, Time Counter, LCD Tachometer

The self-powered H7E series features a large display with 8.6 mm character height. It includes models with backlight for improved visibility in dimly lit places. The 1/32 DIN size family includes total counters, time counters and tachometers.



- 1/32 DIN size: 24 H x 48 W x 55.5 D mm
- Black or light-grey housing
- Make all basic settings with a DIP switch
- 8 digits (H7EC), 7 digits (H7ET), 5 digits (H7ER), 8.6 mm character height
- Dual input speed: 30 Hz <-> 1 kHz (H7EC)



- Dual time ranges in each model (H7ET)
- Dual revolution display (H7ER)

## Ordering Information

### H7EC Count Totalizer [Quick Link T423]

Count input	Max. counting speed	Display	Model	
			Light grey body	Black body
No-voltage	30 Hz <-> 1 kHz (switchable)	7-segment LCD	H7EC-N	H7EC-N-B
PNP/NPN universal DC voltage input	30 Hz <-> 1 kHz (switchable)	7-segment LCD	H7EC-NV	H7EC-NV-B
		7-segment LCD with backlight	H7EC-NV-H	H7EC-NV-BH
AC/DC multi-voltage input	20 Hz	7-segment LCD	H7EC-NFV	H7EC-NFV-B

### H7ET Time Totalizer [Quick Link T424]

Timer input	Display	Model			
		Time range 999999.9h <-> 3999d23.9h (switchable)		Time range 999h59m59s <-> 9999h59.9m (switchable)	
		Light grey body	Black body	Light grey body	Black body
No-voltage input	7-segment LCD	H7ET-N	H7ET-N-B	H7ET-N1	H7ET-N1-B
PNP/NPN universal DC voltage input	7-segment LCD	H7ET-NV	H7ET-NV-B	H7ET-NV1	H7ET-NV1-B
	7-segment LCD with backlight	H7ET-NV-H	H7ET-NV-BH	H7ET-NV1-H	H7ET-NV1-BH
AC/DC multi-voltage input	7-segment LCD	H7ET-NFV	H7ET-NFV-B	H7ET-NFV1	H7ET-NFV1-B

### H7ER Tachometer [Quick Link T425]

Count input	Display	Model			
		Max. revolutions displayed (applicable encoder resolution)			
		1,000 s-1 (1 pulse/rev.) 1,000 min-1 (60 pulse/rev.)		1,000.0 s-1 (10 pulse/rev.) 1,000.0 min-1 (600 pulse/rev) <-> 10,000 min-1 (60 pulse/rev) (switchable)	
		Light grey body	Black body	Light grey body	Black body
No-voltage input	7-segment LCD	H7ER-N	H7ER-N-B	-	-
PNP/NPN universal DC voltage input	7-segment LCD	H7ER-NV	H7ER-NV-B	H7ER-NV1	H7ER-NV1-B
	7-segment LCD with backlight	H7ER-NV-H	H7ER-NV-BH	H7ER-NV1-H	H7ER-NV1-BH

# H7BX Digital Counters

Quick Link  
T427

## 72 x 72 mm Multi-Function Counter with a Bright, Easy-to-view, Negative Transmissive LCD

- Provides a total and preset counter, batch counter, dual counter, and tachometer
- Large highly visible display with backlit transmissive LCD
- Selectable display color (red/green) enables checking output status at a distance
- Easy operation with a key for each digit
- Perform all basic settings with a DIP switch



### Specifications

- Supply voltage: 100 to 240 VAC, 24 VAC/12 to 24 VDC
- Inputs: Voltage or no-voltage inputs; 12 VDC external power supply
- Ranges: Counting -99,999 to 999,999 (6-digit); tachometer 0 to 999,999 (6 digits)

- Wide range of inputs accepted for NPN/ PNP inputs (multi-inputs) and 2-wire DC sensors
- Degree of protection: IP54 equivalent (front section only)
- Control output: Contact output: 3 A at 250 VDC/30 VDC (resistive load); transistor output: 100 mA max. at 30 VDC max.
- Output functions: One-shot and sustained outputs with up to 12 user selections
- Reset time: 1 ms or 20 ms selectable

# H7CN Digital Counters

Quick Link  
T428

## 1/16 DIN, Single Preset Counter with Four-Digit LED Display

- Simple to set and operate
- Easy-to-read 8 mm-high LED display
- Contact (SPST-NO or SPDT) or solid-state (open-collector) outputs
- Single counting speed per model: 30 cps models stocked; 5 kcps available
- Separate UP, DOWN and REVERSIBLE counting models
- Memory protection circuit available on AC models
- 8-pin or 11-pin round socket models available
- Panel-mount adapter, sockets and accessories available separately



### Specifications

- Supply voltage: 100-240 VAC, 50/60 Hz
- Counting functions: 1-stage (single preset) UP counter
- Counting ranges: 0 to 9,999 (4-digit)
- Output functions: Sustained output until reset

T

# Counters

---

<b>Contents</b>		
<b>Selection Guide</b>		U-ii
<b>Digital Panel Meters</b>		
<b>K3HB-X, -H, -V, -S</b>	Process, Temperature, Weighing and Linear Sensor Indicators	U-1
<b>K3HB-C, -P, -R</b>	Rotary Pulse, Timer Interval and Up-/Down-Counting Pulse Indicators	U-2
<b>K3MA-J, -L, -F</b>	Process, Temperature, Frequency/Rate Meters with Built-in Outputs	U-3
<b>K3GN</b>	1/32 DIN Process Meter with Relay or Transistor Output	U-3
<b>Liquid Level Controls and Detectors</b>		
<b>61F</b>	Conductive level controllers with sensitivity adjustment for automatic water supply and drainage	U-4
<b>K7L-UP-FLK</b>	Pinpoint Liquid Leakage Location by Sensing Distance or by Area	U-5
<b>K7L-AT50</b>	Protect your Process Equipment from Liquid Spills and Leaks	U-6

## LOOKING FOR PERFECT MEASURING & READ-OUT?

### K3HB-V – For perfect weighing

With our K3HB series, we cover a wide range of applications. One of them is the weighing indicator which performs perfect measurement in any weighing application. The instrument can be equipped with a load-cell power supply of 10 V/100 mA. Several option boards for communication, contact output boards or event inputs are also available. On top of these, you can get direct DeviceNet communication.

- High-speed sampling 20 ms
- Equipped with position meter
- Two-color display for easy recognition

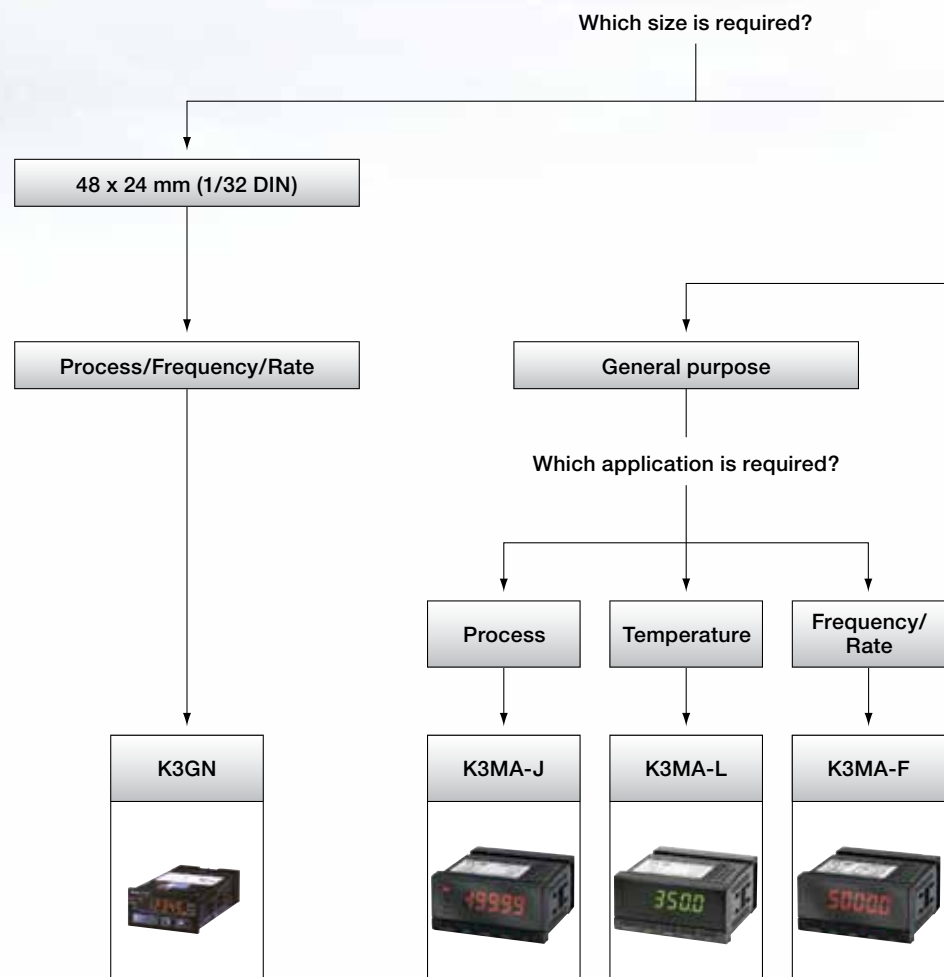

96 x 48 mm (1/8 DIN)



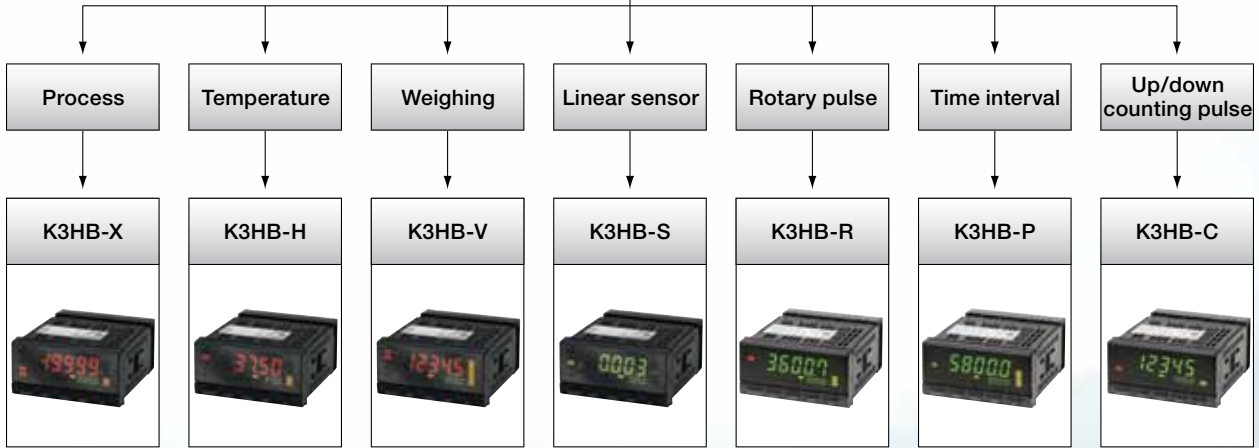

Advanced

Which application is required?









# Selection Table

Category		Multifunctional Digital Panel Indicator	Process Indicator	Temperature Indicator	Frequency/Rate Indicator
Selection Criteria					
	Model	K3GN	K3MA-J	K3MA-L	K3MA-F
	Size	1/32 DIN	1/8 DIN	1/8 DIN	1/8 DIN
Features	Color change display	■	■	■	■
	Number of digits	5	5	4	5
	Leading zero suppression	■	■	■	■
	Forced zero function	■	■	■	■
	Min./max. hold function	■	■	■	■
	Average processing	■	■	■	■
	User selectable inputs	■	■	■	■
	Start-up compensating time	■	–	–	■
	Key protection	■	■	■	■
	Decimal pt. position setting	■	■	■	■
	Accuracy	±0.1% of full scale			
	Input range	0 to 20 mA, 4 to 20 mA or 0 to 5 V, 1 to 5 V, -5 to 5 V, -10 to 10 V or 0 to 30 Hz or 0 to 5 kHz	0 to 20 mA, 4 to 20 mA or 0 to 5 V, 1 to 5 V, -5 to 5 V, -10 to 10 V	Pt100, JPt100 or thermocouple K, J, T, E, L, U, N, R, S, B	0 to 30 Hz or 0 to 5 kHz
	Sample rate	250 ms	250 ms	500 ms	–
	Features	Remote/local processing, parameter initialization, programmable output configuration, process value hold	Teaching, comparative output pattern selection, parameter initialization, programmable output configuration, process value hold	Programmable output configuration, process value hold	Teaching, comparative output pattern selection, programmable output configuration, process value hold
	Sensor power supply	–	–	–	■
	Front protection – IP rating	IP66/NEMA 4	IP66/NEMA 4	IP66/NEMA 4	IP66/NEMA 4
	Supply voltage	24 VDC	24 VAC/VDC or 100 to 240 VAC	24 VAC/VDC or 100 to 240 VAC	24 VAC/VDC or 100 to 240 VAC
Inputs	NPN	■	–	–	■
	PNP	■	–	–	■
	Temperature	–	–	–	–
	Contact	–	–	–	■
	Voltage pulse	–	–	–	■
	Load cell	–	–	–	–
	DC voltage	■	■	–	–
	DC current	■	■	–	–
	AC voltage	–	–	–	–
AC current	–	–	–	–	
Outputs	Relay	■	■	■	■
	NPN	■	–	–	–
	PNP	■	–	–	–
	Linear	–	–	–	–
	BCD	–	–	–	–
	Comms	■	–	–	–



■ Standard    □ Available    – No/not available

# Digital Panel Meters

Category		Process Indicator	Temperature Indicator	Weighing Indicator	Linear Sensor Indicator
Selection Criteria					
	Model	K3HB-X	K3HB-H	K3HB-V	K3HB-S
	Size	1/8 DIN	1/8 DIN	1/8 DIN	1/8 DIN
Features	Color change display	■	■	■	■
	Number of digits	5	5	5	5
	Leading zero suppression	■	■	■	■
	Forced zero function	■	■	■	■
	Min./max. hold function	■	■	■	■
	Average processing	■	■	■	■
	User selectable inputs	■	■	■	■
	Start-up compensating time	–	–	–	–
	Key protection	■	■	■	■
	Decimal pt. position setting	■	■	■	■
	Accuracy	±0.1% of full scale (DC voltage & DC current), ±0.5% of full scale (AC voltage & AC current)	Thermocouple: ±0.3% of full scale, Pt-100: ±0.2% of full scale	±0.1% of full scale	One input: ±0.1% of full scale, two inputs: ±0.2% of full scale
	Input range	0.000 to 10.000 A 0.0000 to 19.999 mA -199.99 to 199.99 mA 4.000 to 20.000 mA 0.0 to 400.0 V 0.0000 to 1.999 V -199.99 to 199.99 V 1.0000 to 5.0000 V	Pt100, thermocouple K, J, T, E, L, U, N, R, S, B, W	0.00 to 199.99 mV, 0.000 to 19.999 mV, 100.00 mV, 199.99 mV	0 to 20 mA, 4 to 20 mA, 0 to 5 V, -5 to 5 V, -10 to 10 V
	Sample rate	20 ms	20 ms	20 ms	0.5 ms
	Features	Scaling, teaching, averaging, output hysteresis, output OFF-delay, output test, bank selection, reset, comparative output	Scaling, teaching, averaging, output hysteresis, output OFF-delay, output test, bank selection, reset, comparative output	Scaling, teaching, averaging, output hysteresis, output OFF-delay, output test, bank selection, reset, comparative output	Scaling, 2-input calculation, teaching, averaging, output hysteresis, output OFF-delay, output test, bank selection, reset, comparative output
Sensor power supply	<input type="checkbox"/>	<input type="checkbox"/>	<input type="checkbox"/>	<input type="checkbox"/>	
Front protection – IP rating	IP66/NEMA 4	IP66/NEMA 4	IP66/NEMA 4	IP66/NEMA 4	
Supply voltage	100 to 240 VAC or 24 VAC/VDC	100 to 240 VAC or 24 VAC/VDC	100 to 240 VAC or 24 VAC/VDC	100 to 240 VAC or 24 VAC/VDC	
Inputs	NPN	<input type="checkbox"/>	<input type="checkbox"/>	<input type="checkbox"/>	<input type="checkbox"/>
	PNP	<input type="checkbox"/>	<input type="checkbox"/>	<input type="checkbox"/>	<input type="checkbox"/>
	Temperature	–	■	–	–
	Contact	–	–	–	–
	Voltage pulse	–	–	–	–
	Load cell	–	–	■	–
	DC voltage	<input type="checkbox"/>	–	–	■
	DC current	<input type="checkbox"/>	–	–	■
	AC voltage	<input type="checkbox"/>	–	–	–
AC current	<input type="checkbox"/>	–	–	–	
Outputs	Relay	<input type="checkbox"/>	<input type="checkbox"/>	<input type="checkbox"/>	<input type="checkbox"/>
	NPN	<input type="checkbox"/>	<input type="checkbox"/>	<input type="checkbox"/>	<input type="checkbox"/>
	PNP	<input type="checkbox"/>	<input type="checkbox"/>	<input type="checkbox"/>	<input type="checkbox"/>
	Linear	<input type="checkbox"/>	<input type="checkbox"/>	<input type="checkbox"/>	<input type="checkbox"/>
	BCD	–	–	–	–
	Comms	<input type="checkbox"/>	<input type="checkbox"/>	<input type="checkbox"/>	<input type="checkbox"/>

■ Standard    □ Available    – No/not available

# Selection Table



Category		Up/Down Counting Pulse Indicator	Time Interval Indicator	Rotary Pulse Indicator
Selection Criteria				
	Model	K3HB-C	K3HB-P	K3HB-R
	Size	1/8 DIN	1/8 DIN	1/8 DIN
Features	Color change display	■	■	■
	Number of digits	5	5	5
	Leading zero suppression	■	■	■
	Forced zero function	■	■	■
	Min./max. hold function	■	■	■
	Average processing	■	■	■
	User selectable inputs	■	■	■
	Start-up compensating time	–	–	■
	Key protection	■	■	■
	Decimal pt. position setting	■	■	■
	Accuracy	–	±0.08% rgd ±1 digit	±0.006% rgd ±1 digit ±0.02% rgd ±1 digit
	Input range	No voltage contact: 30 Hz, voltage pulse: 50 kHz, open collector: 50 kHz	No voltage contact: 30 Hz, voltage pulse: 50 kHz, open collector: 50 kHz	No voltage contact: 30 Hz, voltage pulse: 50 kHz, open collector: 50 kHz
	Sample rate	–	–	–
	Features	Scaling, measurement operation selection, output hysteresis, output OFF-delay, output test, display value selection, display color selection, key protection, bank selection, display refresh period, maximum/minimum hold, reset	Scaling, measurement operation selection, output hysteresis, output OFF-delay, output test, teaching, display value selection, display color selection, key protection, bank selection, display refresh period, maximum/minimum hold, reset	Scaling, measurement operation selection, averaging, previous average value comparison, output hysteresis, output OFF-delay, output test, teaching, display value selection, display color selection, key protection, bank selection, display refresh period, maximum/minimum hold, reset
	Sensor power supply	□	□	□
	Front protection – IP rating	IP66/NEMA 4	IP66/NEMA 4	IP66/NEMA 4
	Supply voltage	100 to 240 VAC or 24 VAC/VDC	100 to 240 VAC or 24 VAC/VDC	100 to 240 VAC or 24 VAC/VDC
Inputs	NPN	■	■	■
	PNP	■	■	■
	Temperature	–	–	–
	Contact	–	–	–
	Voltage pulse	■	■	■
	Load cell	–	–	–
	DC voltage	–	–	–
	DC current	–	–	–
	AC voltage	–	–	–
	AC current	–	–	–
Outputs	Relay	□	□	□
	NPN	□	□	□
	PNP	□	□	□
	Linear	□	□	□
	BCD	□	□	□
	Comms	□	□	□

■ Standard    □ Available    – No/not available

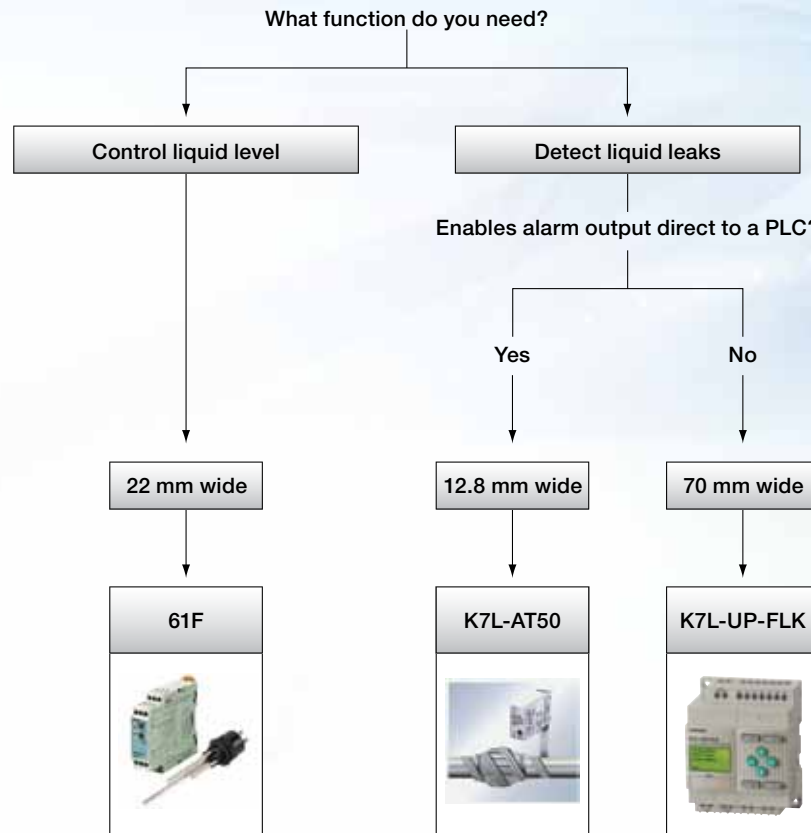
# Liquid Level Controller/Leakage Detectors



# Selection Table

Category	Liquid Level Control	Leakage Detection	Liquid Leakage Position
			
Model	61F	K7L-AT50	K7L-UP-FLK
Function	Floatless level control for liquid supply and drainage operations	Detects liquid spills using a conductive sensing band and socket-mount controller	Pinpoint location of liquid spills over a 600 m span or in areas to determine extent or multiple leaks
Compatible liquids	City and industrial water, sewage	Water, ammonia, and Hydrogen Peroxide	Water, Ammonia, Sulfuric Acid, Phosphoric acid, Caustic soda, and Sodium sulfite
Operating resistance	10 to 100 k $\Omega$ (variable)	0 to 50 M $\Omega$ (variable)	50 k $\Omega$ , 100 k $\Omega$ (selectable)
Inputs	Conductive electrodes: SUS304 or SUS316, 1 m long segments	Sensing band: Polyethylene standard; PTFE fluoro-resin for high temperature and organic solvents, 10 m max. length	Fluoro-resin band; 2, 5, 10 and 30 m length
Supply voltage	100-240 VAC, 24 VAC/VDC	12 to 24 VDC	100-240 VAC
Dimensions H x W x D mm	100 x 22.5 x 100	85.5 x 19.5 x 84 max. in socket	90 x 70 x 59

# K3HB-X, -H, -V, -S

## Digital Panel Indicators

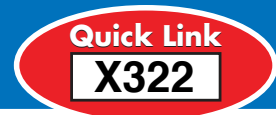

### Process, Temperature, Weighing and Linear Sensor Indicators

These indicators with analog input, feature a color change display for easy monitoring. K3HB series is high-speed, with a sample rate of 50 Hz, and even 2,000 Hz for K3HB-S.



- Optional DeviceNet, RS-232C, RS-485
- 1/8 DIN size, IP66 rated NEMA 4 housing

### Ordering Information

Type of indicator	Input sensor type and range	Model
Process indicator K3HB-X	DC current input, from $\pm 199.99$ mA, to 4.000 to 20.000 mA	K3HB-XAD 100-240VAC
		K3HB-XAD 24VAC/VDC
	DC voltage input, from $\pm 199.99$ V to 1.0000 to 5.0000 V	K3HB-XVD 100-240VAC
		K3HB-XVD 24VAC/VDC
Temperature indicator K3HB-H	Temperature input Pt100, thermocouple K, J, T, E, L, U, N, R, S, B, W	K3HB-HTA 100-240VAC
		K3HB-HTA 24VAC/VDC
Weighing indicator K3HB-V	Load cell input (DC low voltage input), 0.00 to 199.99 mV, 0.000 to 19.999 mV, 100.00 mV, 199.999 mV	K3HB-VLC 100-240 VAC
		K3HB-VLC 24VAC/VDC

### Sensor Power Supply/Output Boards

Slot	Output	Sensor power supply	Communications	Applicable indicator types	Model	
B	Relay	PASS: SPDT	12 VDC $\pm 10\%$ , 80 mA	-	K3HB-X, -H, -S	K33-CPA
	Linear current	DC0(4) - 20 mA		-	K3HB-X, -H, -S	K33-L1A
	Linear voltage	DC0(1) - 5 V, 0 to 10 V		-	K3HB-X, -H, -S	K33-L2A
	Sensor power supply only			-	K3HB-X, -H, -S	K33-A
				RS-232C	K3HB-X, -H, -S	K33-FLK1A
				RS-485	K3HB-X, -H, -S	K33-FLK3A
	Relay	PASS: SPDT	10 VDC $\pm 5\%$ , 100 mA	-	K3HB-V	K33-CPB
	Linear current	DC0(4) - 20 mA		-	K3HB-V	K33-L1B
	Linear voltage	DC0(1) - 5 V, 0 to 10 V		-	K3HB-V	K33-L2B
	Sensor power supply only			-	K3HB-V	K33-B
				RS-232C	K3HB-V	K33-FLK1B
				RS-485	K3HB-V	K33-FLK3B

### Relay/Transistor Output Boards

Slot	Output	Communications	Model
C	Relay	H/L: SPDT each	K34-C1
		HH/H/LL/L: SPST-NO each	K34-C2
	Transistor	NPN open collector: HH/H/PASS/L/LL	K34-T1
		PNP open collector: HH/H/PASS/L/LL	K34-T2
	-	-	DeviceNet

### Event Input Boards

Slot	Output	Number of points	Communications	Model
DT	NPN open collector	5	M3 terminal blocks	K35-1
	PNP open collector	5	M3 terminal blocks	K35-3

## Rotary Pulse, Timer Interval and Up/Down Counting Pulse Indicators

These indicators with analog input feature a clear and easy-to-use color change display. All models are equipped with NEMA 4 IP66 housing. K3HB-R and -C are high-speed, with a color rate up to 50 kHz.



- Position meter indication for easy monitoring
- Optional DeviceNet, RS-232C, RS-485
- Double display with 5 digits in two colors
- 1/8 DIN size housing

## Ordering Information

Type of indicator	Quick link code	Input ranges	Input sensor	Model
Rotary pulse indicator K3HB-R	X328	No voltage contact: 30 Hz max. Voltage pulse: 50 kHz max. Open collector: 50 kHz max.	NPN input/voltage pulse	K3HB-RNB 100-240VAC
				K3HB-RNB 24VAC/VDC
			PNP input	K3HB-RPB 100-240VAC
				K3HB-RPB 24VAC/VDC
Timer interval indicator K3HB-P	X327		NPN	K3HB-PNB 100-240VAC
			PNP	K3HB-PPB 100-240VAC
			PNP	K3HB-PPB 24VAC/VDC
			NPN	K3HB-CNB 100-240VAC
Up/down counting pulse indicator K3HB-C	X326		NPN	K3HB-CNB 24VAC/VDC
			PNP	K3HB-CPB 24VAC/VDC
		PNP	K3HB-CPB 100-240VAC	

## Sensor Power Supply/Output Boards

Slot	Output	Sensor power supply	Communications	Model	
B	Relay	12 VDC $\pm$ 10%, 80 mA	-	K33-CPA	
	Linear current		DC0(4) - 20 mA	-	K33-L1A
	Linear voltage		DC0(1) - 5 V, 0 to 10 V	-	K33-L2A
	-		-	-	K33-A
	-		-	RS-232C	K33-FLK1A
	-		-	RS-485	K33-FLK3A
	-		-		

## Relay/Transistor Output Boards

Slot	Output	Communications	Model	
C	Relay	H/L: SPDT each	-	K34-C1
		HH/H/LL/L: SPST-NO each	-	K34-C2
	Transistor	NPN open collector: HH/H/PASS/L/LL	-	K34-T1
		PNP open collector: HH/H/PASS/L/LL	-	K34-T2
	-	-	DeviceNet	K34-DRT
	BCD + transistor	NPN open collector: HH/H/PASS/L/LL	-	K34-BCD

## Event Input Boards

Slot	Output	Number of points	Communications	Model
D	NPN open collector	5	M3 terminal blocks	K35-1
	NPN open collector	5	M3 terminal blocks	K35-3

# K3MA-J, -L, -F Digital Panel Meters



## Digital Panel Meters Offer Built-in Outputs, 1/8 DIN Size

The K3MA series comes with a process meter, a frequency/rate meter and a temperature meter of either 100 to 240 VAC or 24 VAC/VDC. All are equipped with the same quality display and have the same short mounting depth of 80 mm.



- 1/8 DIN size housing: 97 L x 96 W x 48 H mm
- Highly visible, 2-color negative transmissive backlit LCD display
- 14.2 mm high characters
- 5 digits (-19,999 to 99,999), K3MA-L: 4 digits
- Front-panel NEMA 4 IP66

### Ordering Information [Quick Links -J = X324, -L = X329, and -F = X323]

Indicator	Supply voltage	Input type and ranges	Output	Model
Process meter	100 to 240 VAC	DC voltage: 0 to 5 V, 1 to 5 V, -5 to 5 V, -10 to 10 V	2 relay contact outputs (SPST-NO)	K3MA-J-A2 100-240VAC
	24 VAC/VDC		2 relay contact outputs (SPST-NO)	K3MA-J-A2 24VAC/VDC
Temperature meter	100 to 240 VAC	Platinum-resistance thermometer: Pt100, JPt100	1 relay contact output (SPDT)	K3MA-L-C 100-240VAC
	24 VAC/VDC		1 relay contact output (SPDT)	K3MA-L-C 24VAC/VDC
Frequency/rate meter	100 to 240 VAC	Rotary pulse - No voltage: 0.05 to 30.00 Hz	2 relay contact outputs (SPST-NO)	K3MA-F-A2 100-240VAC
	24 VAC/VDC		2 relay contact outputs (SPST-NO)	K3MA-F-A2 24VAC/VDC

# K3GN Digital Panel Meters



## Compact and Intelligent Digital Panel Meter, 1/32 DIN Size

The K3GN is able to cover a wide variety of applications with its three main functions: process meter, RPM processor/tachometer and digital data display for PC/PLC. Configuration is easy and the design is advanced and compact.



- Process indicator DC voltage/current
- RPM process/tachometer
- Digital data display for PC/PLC
- Very compact 1/32 DIN housing: 24 H x 48 W x 83 D mm
- 5-digit display with programmable display color, in red or green
- Front panel NEMA 4/IP66

### Ordering Information

Input type	Supply voltage	Output	Model	
			No communications	RS-485
DC voltage/current, NPN	24 VDC	Dual relays (SPST-NO)	K3GN-NDC 24 DC	K3GN-NDC-FLK 24 DC
DC voltage/current, PNP		Dual relays (SPST-NO)	K3GN-PDC 24 DC	K3GN-PDC-FLK 24 DC





## Ultra-Slim 22 mm Single or Two-Point Level Controller

- Reliable, floatless level control for automatic water supply and drainage in industrial facilities and equipment
- Adjustable sensitivity for conductive liquids ranging from distilled water, city water, well water, industrial water, sea water and sewage, with specific resistance from 10 to 100 kΩ impedance
- Delay timer to prevent relay contact chatter from waves
- System components consist of a controller, electrodes and electrode mounting accessories



- DIN-rail or screw-mount options
- Dimensions: 90 H x 22.5 W x 100 D mm

## Floatless, Conductive Level Controller

Features	Input voltage	Output	Model
3-electrode system for water supply or drainage control; order electrodes, holders and socket separately Adjustable operating resistance sensitivity	24 VAC/VDC	One SPDT-NC, 6 A at 250 VAC/30 VDC	61F-D21T-V1 24VAC/DC
	100 to 240 VAC		61F-D21T-V1 100-240VAC

## Electrodes, Connecting, and Lock Nuts

Applicable liquids	Material	Component	Indication mark	Inscription	Model
Purified city water, industrial water, sewage	SUS304	Electrode (1 m long)	1 line	---	F03-01 SUS304
		Connecting nut	---		F03-02 SUS304
		Locking nut			F03-03 SUS304
Purified city water, industrial water, sewage, dilute alkaline solution	SUS316	Electrode (1 m long)	2 lines	6 316	F03-01 SUS316
		Connecting nut	---		F03-02 SUS316
		Locking nut			F03-03 SUS316

## Electrode Holders and Separators

Application	Mounting	Insulator Material	Max. temperature	Number of electrodes	Model
For city water and other general use Easy-to-replace separate version for maintenance.	Flange	Phenol resin	70°C	3	PS-3S
	When mounting space is limited Special 3-pole holder of small size and light weight			Screw	3, 300 mm
		3, 1000 mm	PS-31-1000 MM		
Use for sewage, sea water, etc., having a low specific resistance	Flange	Ceramics	150°C (without water drips or vapor on the electrode holder surface)	1	BF-1
For resistance to high pressure Use in tanks with high temperature or pressure	Screw	PTFE	250°C (without water drips or vapor on the electrode holder surface)	1	BS-1
Electrode separators				1	F03-14 1P
				3	F03-14 3P

# K7L-UP-FLK

## Liquid Leakage Position Sensor



### Pinpoint Liquid Leakage Location by Sensing Distance or by Area

This sensor minimizes downtime of critical equipment due to liquid leakage while protecting important facilities from damage. The K7L-UP-FLK accurately identifies the leakage location up to 1,968 Ft. (600 m) away to take prompt maintenance measures; it even displays a second location to help determine the extent of an expanding spill.



- Highly visible, 2-color backlit LCD display
- 2 relay outputs (NO/NC) and 4 to 20-mA outputs
- Supports RS-485 communications (CompoWay/F and Modbus) for easy connection to a PLC or touch panel
- Chemical resistant sensing cable made of fluorocarbon resin is safe for clean room use
- Convenient track-mount design: 90 H x 70 W x 56 D mm
- Front-panel IP20

### Ordering Information

Description	Specification	Model
Liquid Leakage Sensor Amplifier	Includes controller (K7L-UP-FLK), connecting cable (F03-21UP-CC) and terminator (F03-20UP-TC); order sensing cable separately; 100-240 VAC	K7L-UP-FLK-P
Sensing Cables	2 m length	F03-16UP-C-2M
	5 m length	F03-16UP-C-5M
	10 m length	F03-16UP-C-10M
	30 m length	F03-16UP-C-30M
Junction Cable	Extends cable sensing distance; 2.05 m length	F03-21UP-JC
Area Separator	Enables accurate identification of the detection area where a leak occurred even when the leak occurs near an area boundary; 120 mm length	F03-20UP-AS
Cable Stickers	Fastens cable to surfaces; 30 stickers per bag	F03-25

### Typical Applications

Semiconductor factory recovers production quickly after a DI water or harsh chemical leak	Computer center humidity control reduces leakage from air conditioning to maintain optimal environment	Pharmaceutical factory prevents underground soil contamination and damage outside from leaks
		

## Protect your Process Equipment from Liquid Spills and Leaks

- Detects liquid leaks by monitoring the resistance between conductive sensing bands
- Four selectable sensing ranges for liquids with impedance high as 50 MΩ
- Ideal for all grades of water, ammonia (NH<sub>3</sub>), hydrogen peroxide (H<sub>2</sub>O<sub>2</sub>), hydrochloric acid (HCl), phosphoric acid (H<sub>3</sub>PO<sub>4</sub>), fluorine (F) and isopropyl alcohol (IPA)
- Track-mount sockets and plug-in sensor amplifier simplify installation and maintenance



## Liquid Leakage Sensor

Description	Input signal	Output signal	Dimensions (mm)	Supply voltage	Model
Liquid Leakage Sensor Amplifier	0 to 50 MΩ impedance	NPN open collector, 100 mA at 30 VDC	28.8 H x 12.8 W x 46 D	24 VDC	K7L-AT50

## Sensing Bands

Description	Specification and appearance	Model
Sensing band, 1 m length	Sheath: polyethylene; Core: 316 stainless steel; 8 W x 1.7 H mm	F03-16PE-1M
Sensing band, 2 m length		F03-16PE-2M
Sensing band, 5 m length		F03-16PE-5M
Sensing band, 10 m length		F03-16PE-10M
Sensing band, 25 m length		F03-16PE-25M
Sensing band, 50 m length		F03-16PE-50M
Adhesive backed sensing band mounting bracket; 30 per pack	Material: Polyethylene; 13 L x 32 W x 3 H mm	F03-26PES
Screw mount sensing band bracket with two M3.5 dia. hole; 30 per pack	Material: Polyethylene; 13 L x 32 W x 3 H mm	F03-26PEN
Terminal block; 10 per pack	17 H x 29.1 W x 25 D mm Connects Sensing Band to Wiring Cable for sensor amplifier	F03-20
Socket with finger-protection	85.5 H x 16 W x 61 D mm Mounts sensor amplifier to DIN rail	P2RF-08-E
Socket	71.5 H x 19.5 W x 54 D mm Mounts sensor amplifier to DIN rail	P2RF-08

## Contents

<b>Selection Guide</b>		V-ii
<b>Single-Phase</b>		
<b>S8VS</b>	DIN Rail Mount with Smart Display	V-1
<b>S8VE</b>	Track Mount Industrial	V-2
<b>S8VM</b>	DC Source with Unique Undervoltage Alarm	V-3
<b>S8JX</b>	Cost-Effective with Multiple Mounting Options	V-4
<b>Three-Phase</b>		
<b>S8VT-F</b>	Compact 3-Phase Input DC Source with Unique Undervoltage Alarm	V-5

## RELIABLE DC POWER FOR YOUR PANEL

Keep critical equipment operational with Omron Smart Display Power Supplies

S8VS - Power Supplies (60-480 W models) have preventive maintenance alarm output. S8VS-A 60-480 W Power Supplies are equipped with a Smart Display screen that allows maintenance staff to see remaining service life. That allows maintenance crews to replace models before end of life, minimizing equipment down time.

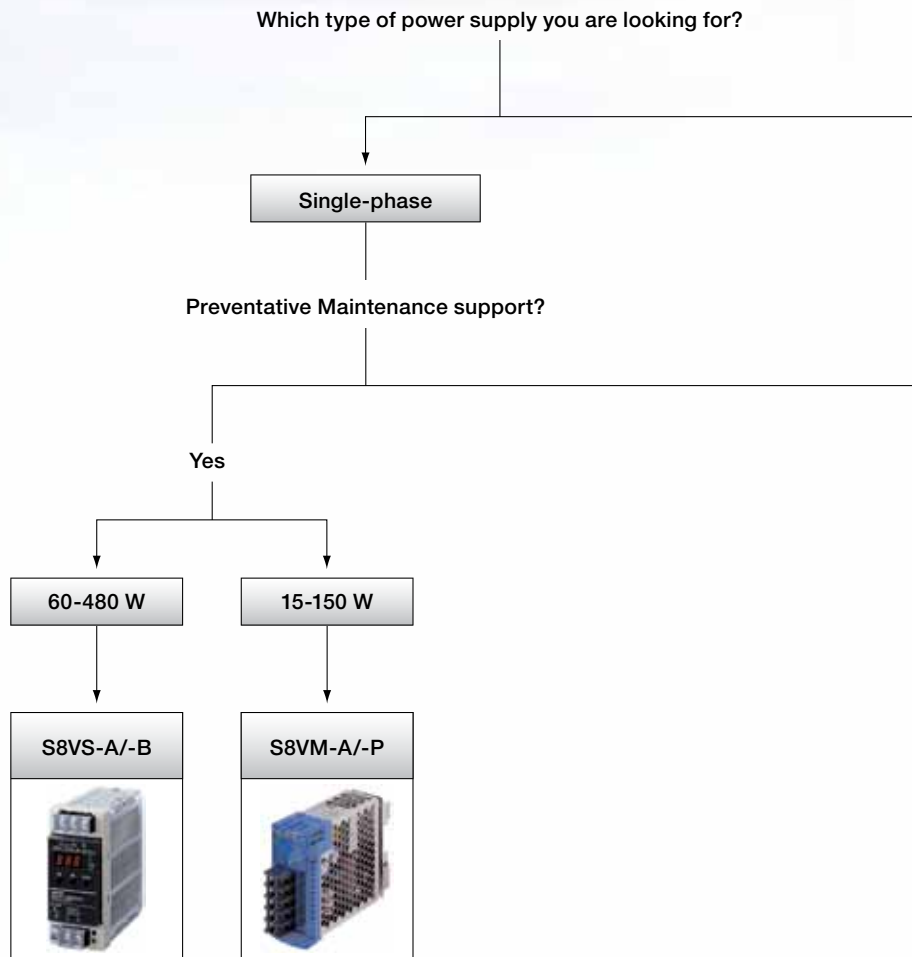

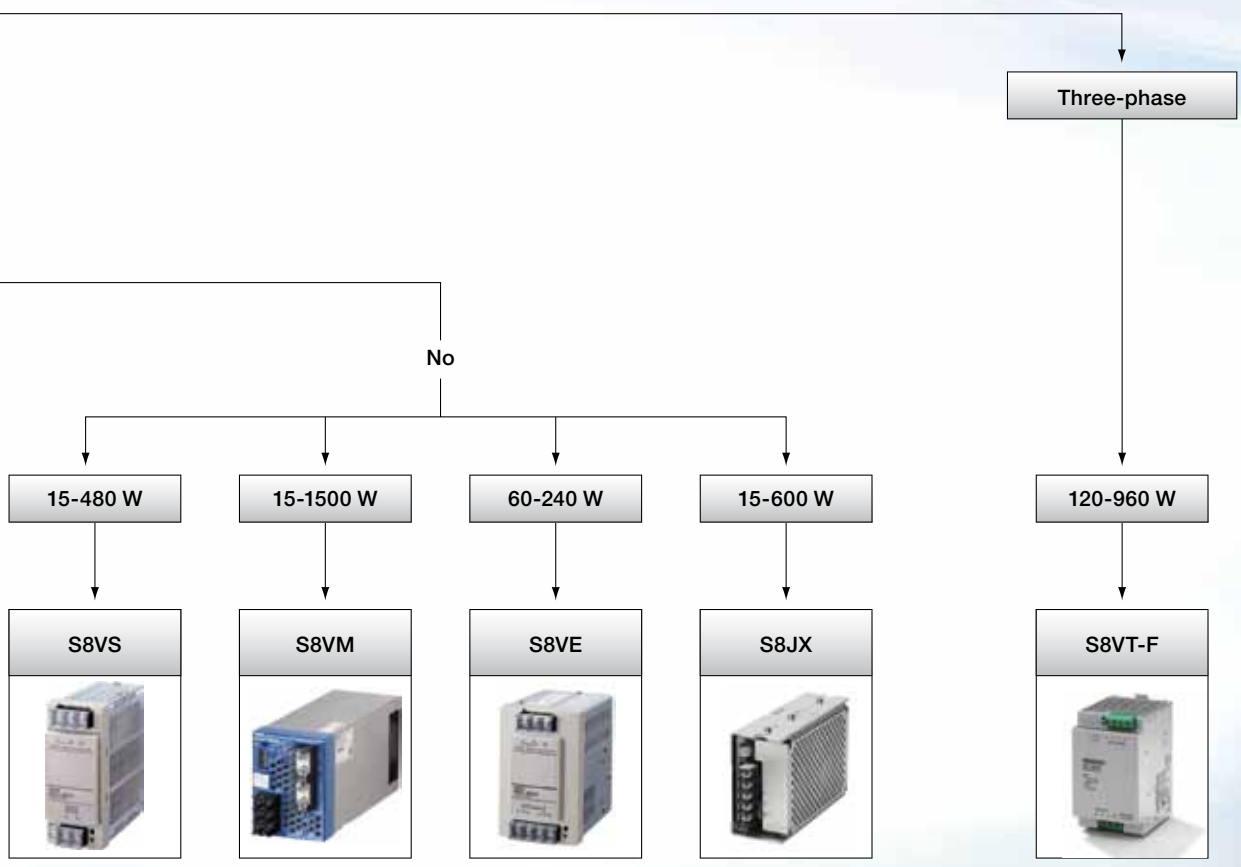

# Selection Table

Category		Compact Power Supplies				Slim Power Supplies		
								
Selection Criteria	Model	S8VS			S8VE	S8VM		
	Phases	Single-phase						
	Rated voltage	100 to 240 VAC						
Power	Voltage	5 V	12 V	24 V	24 V	5 V	12 V	24 V
	3 W	–	–	–	–	–	–	–
	7.5 W	–	–	–	–	–	–	–
	10 W	–	–	–	–	–	–	–
	15 W	2.0 A	1.2 A	0.65 A	–	3.0 A	1.3 A	0.65 A
	25 W	–	–	–	–	–	–	–
	30 W	4.0 A	2.5 A	1.3 A	–	6.0 A	2.5 A	1.3 A
	35 W	–	–	–	–	–	–	–
	50 W	–	–	–	–	–	4.3 A	2.2 A
	60 W	–	–	1.3 A	–	–	–	–
	90 W	–	–	7.5 A	2.5 A	–	–	–
	100 W	–	–	–	3.75 A	20.0 A	8.5 A	4.5 A
	120 W	–	–	5 A	5 A	–	–	–
	150 W	–	–	–	–	27.0 A	12.5 A	6.5 A
	180 W	–	–	7.5 A	7.5 A	–	–	–
	240 W	–	–	10 A	10 A	–	–	–
	300 W	–	–	–	–	–	27 A	14 A
	480 W	–	–	20 A	–	–	–	–
	600 W	–	–	–	–	–	53 A	27 A
	960 W	–	–	–	–	–	–	–
1500 W	–	–	–	–	–	–	70 A	
Functions	SEMI F47-0200 (200 VAC input)	■	■	■	–	■	■	■
	DC back-up	–	–	–	–	–	–	–
	Capacitor back-up	–	–	□	–	–	–	–
	Undervoltage alarm	–	–	■	–	–	–	■
	Oversvoltage protection	–	–	■	■	–	■	■
	Overload protection	–	–	■	■	–	■	■
	DIN-rail mounting	■	■	■	■	–	■	■
	Screw mounting (with bracket)	–	–	–	–	–	■	■
	EMI Class B	–	–	–	–	–	■	■
	UL Class 2	■	■	■ 60 W only	–	–	–	–
	Parallel operation	–	–	–	–	–	–	–
	Series operation	–	–	■	■	–	■	■
	Service life display/output	–	–	□ 60-480 W	–	–	–	–
Load run-time display/output	–	–	□ 60-480 W	–	–	–	–	

■ Standard    □ Available    – No/not available



Category		Slim Power Supplies					
Selection Criteria	Model	S8JX				S8VT-F	
	Phases	Single-phase				Three-phase	
	Rated voltage	100 to 240 VAC				340 to 576 VAC	
Power	Voltage	5 V	12 V	15 V	24 V	24 V	
	3 W	–	–	–	–	–	
	7.5 W	–	–	–	–	–	
	10 W	–	–	–	–	–	
	15 W	3 A	1.3 A	1 A	0.65 A	–	
	25 W	–	–	–	–	–	
	30 W	–	–	–	–	–	
	35 W	7 A	3 A	2.4 A	1.5 A	–	
	50 W	10 A	4.2 A	–	2.1 A	–	
	60 W	–	–	–	–	–	
	90 W	–	–	–	–	–	
	100 W	20 A	8.5 A	–	4.5 A	–	
	120 W	–	–	–	–	5 A	
	150 W	30 A	13 A	–	6.5 A	–	
	180 W	–	–	–	–	–	
	240 W	–	–	–	–	10 A	
	300 W	–	–	–	14 A	–	
	480 W	–	–	–	–	20 A	
	600 W	–	–	–	27 A	–	
	960 W	–	–	–	–	40 A	
	1500 W	–	–	–	–	–	
Functions	SEMI F47-0200 (200 VAC input)	■	■	■	■	–	
	DC back-up	–	–	–	–	–	
	Capacitor back-up	–	–	–	–	–	
	Undervoltage alarm	–	–	–	–	–	
	Overvoltage protection	■	■	■	■	■	
	Overload protection	■	■	■	■	■	
	DIN-rail mounting	■	■	■	■	■	
	Screw mounting (with bracket)	■	■	■	■	□ 960 W only	
	EMI Class B	–	–	–	–	■	
	UL Class 2	–	–	–	–	■	
	Parallel operation	–	–	–	–	■	
	Series operation	■	■	■	■	■	
	Service life display/output	–	–	–	–	–	
Load run-time display/output	–	–	–	–	–		

■ Standard    □ Available    – No/not available



# Power Supplies

---

## Small Sized, DIN Rail Mount Power Supplies with Smart Display

Models with Smart Display for diagnostics and output monitoring show output voltage, output current, and peak hold current.

- Ultra-compact size with wide power range of 15 - 480 W saves panel space
- Unique LED displays and alarm output (60-480 W models) shorten troubleshooting and support preventive maintenance
  - Power supply service life monitor ("A" type)
  - Run-time for connected load monitor ("B" type)
- RoHS compliant
- Power Factor Correction function standard
- Meets international safety standards: UL, cUL, UL508 Listed, SEMI F47 and CE



- Class 2 output (90 W models and below)
- 3-year warranty on all models
- Alarm outputs (90 - 480 W LED models) available: 1 undervoltage outputs, 1 for lifetime or run-time

## Ordering Information

Input voltage	Power rating	Output voltage	Output current	Dimensions H x W x D mm	Model
100 to 240 VAC, 50/60 Hz	15 W	5 VDC	2.0 A	85 x 22.5 x 96.4	S8VS-01505
		12 VDC	1.2 A		S8VS-01512
		24 VDC	0.65 A		S8VS-01524
	30 W	5 VDC	4.0 A		S8VS-03005
		12 VDC	2.5 A		S8VS-03012
		24 VDC	1.3 A		S8VS-03024
	60 W	24 VDC	2.5 A	95 x 40 x 108.3	S8VS-06024
					S8VS-06024A
					S8VS-06024B
	90 W	24 VDC	3.75 A	115 x 50 x 121.3	S8VS-09024
					S8VS-09024S
					S8VS-09024A
					S8VS-09024B
	120 W	24 VDC	5 A	115 x 50 x 121.3	S8VS-12024
					S8VS-12024A
					S8VS-12024B
	180 W	24 VDC	7.5 A	115 x 75 x 125.3	S8VS-18024
					S8VS-18024A
					S8VS-18024B
	240 W	24 VDC	10 A	115 x 100 x 125.3	S8VS-24024
					S8VS-24024A
S8VS-24024B					
480 W	24 VDC	20 A	115 x 150 x 127.2	S8VS-48024	
				S8VS-48024A	
				S8VS-48024B	

## Compact, Track Mount Industrial Power Supplies

- Wide range of power ratings: 60/90/120/180/240-W models
- All models convert 100 to 240 VAC to 24 VDC
- Compact size saves panel space and fits shorter ducts
- Easy to install screwless terminal block models available
- Complies with SEMI F47-0200 (200 VAC input)



## Ordering Information

Input voltage	Power rating	Output voltage	Output current	Connection type	Dimensions H x W x D mm	Model
100 to 240 VAC, 50/60 Hz	60 W	24 VDC	2.5 A	Screw terminal block	95 x 40 x 108.3	S8VE-06024
				Screwless terminal block	95 x 40 x 107.3	S8VE-06024-F
	90 W		3.75 A	Screw terminal block	115 x 50 x 121.2	S8VE-09024
				Screwless terminal block	115 x 50 x 120.3	S8VE-09024-F
	120 W		5 A	Screw terminal block	115 x 50 x 121.2	S8VE-12024
				Screwless terminal block	115 x 50 x 120.3	S8VE-12024-F
	180 W		7.5 A	Screw terminal block	115 x 75 x 125.3	S8VE-18024
				Screwless terminal block	115 x 75 x 124.3	S8VE-18024-F
	240 W		10 A	Screw terminal block	115 x 100 x 125.2	S8VE-24024
				Screwless terminal block	115 x 100 x 124.3	S8VE-24024-F

## Reliable DC Source with Unique Undervoltage Alarm

- Slim DIN-rail mounting units help downsize machine panels
- Overvoltage protection (standard) of 105% to 160% rated load current
- Undervoltage alarm option signals an error and helps identify the source
- Terminal block protects fingers against electric shock
- Enclosed and open frame models available
- RoHS compliant
- Class 1, Div 2 rated for hazardous areas



- Power Factor Correction function standard
- Meets international safety standards: UL 508, 60950-1, 1604 (Class I/Division 2); CSA C22.2 No. 14, No. 60950-1, No. 213 (Class I/Division 2); EN50178, EN60950-1

## Ordering Information

Input voltage	Power rating	Output voltage	Output current	Undervoltage alarm	Efficiency	Dimensions H x W x D mm	Model
100 to 240 VAC, 50/60 Hz	15 W	24 VDC	0.65 A	Yes	80% min.	84.5 x 33.5 x 84.5	S8VM-01524AD
	30 W		1.3 A	Yes	81% min.	84.5 x 33.5 x 99.5	S8VM-03024AD
	50 W		2.2 A	Yes	80% min.	84.5 x 33.5 x 124.5	S8VM-05024AD
	100 W		4.5 A	Yes	82% min.	84.5 x 35 x 164.5	S8VM-10024AD
	150 W		6.5 A	Yes	83% min.	84.5 x 44 x 164.5	S8VM-15024AD
	15 W	5 VDC	3.0 A	N/A	75% min.	84.5 x 33.5 x 84.5	S8VM-01505CD
			1.3 A	N/A	78% min.		S8VM-01512CD
			0.65 A	N/A	80% min.		S8VM-01524CD
	30 W	5 VDC	6.0 A	N/A	75% min.	84.5 x 33.5 x 99.5	S8VM-03005CD
			2.5 A	N/A	79% min.		S8VM-03012CD
			1.3 A	N/A	81% min.		S8VM-03024CD
	50 W	5 VDC	10.0 A	N/A	80% min.	84.5 x 33.5 x 124.5	S8VM-05005CD
			4.3 A	N/A	79% min.		S8VM-05012CD
			2.2 A	N/A	80% min.		S8VM-05024CD
	100 W	5 VDC	20.0 A	N/A	81% min.	84.5 x 35 x 164.5	S8VM-10005CD
8.5 A			N/A	81% min.	S8VM-10012CD		
4.5 A			N/A	82% min.	S8VM-10024CD		
150 W	5 VDC	27.0 A	N/A	81% min.	84.5 x 44 x 164.5	S8VM-15005CD	
		12.5 A	N/A	81% min.		S8VM-15012CD	
		6.5 A	N/A	83% min.		S8VM-15024CD	
300 W		14 A; Peak current: 16.5 A (200 VAC)	N/A	81% min.	83.5 x 62.5 x 188	S8VM-30024C	
600 W		27 A; Peak current: 31 A (200 VAC)	N/A	81% min.	83.8 x 101.8 x 192	S8VM-60024C	
1500 W		65 A (100 VAC), 70 A (200 VAC); Peak current: 105 A (200 VAC)	N/A	82% min.	82 x 126.5 x 327	S8VM-15224C	

Note: Optional mounting brackets available.

## Cost-Effective Power Supplies with Multiple Mounting Options

- Wide power range of 15 - 600 W and voltages (5, 12, 15, 24, 48 VDC)
- Universal input voltage
- Multiple mounting options
- Series operation: connect up to 2
- Parallel operation on 300 and 600 W
- Built-in overload and overvoltage protection
- Approvals: UL, cUL, UL508 Listed, CE, SEMI F47, VDE
- Adjustable voltage output (-10% to 15%)



- Two-year warranty
- 48 W output available

## Ordering Information Power Supplies

Power rating	Output voltage	Output current	Dimensions H x W x D mm	Part numbers			
				Open frame		Covered frame	
				Front* mount	DIN-rail mount	Front* mount	DIN-rail mount
15 W	5 V	3 A	96 x 39.5 x 114.5	S8JX-G01505	S8JX-G01505D	S8JX-G01505C	S8JX-G01505CD
	12 V	1.3 A		S8JX-G01512	S8JX-G01512D	S8JX-G01512C	S8JX-G01512CD
	15 V	1 A		S8JX-G01515	S8JX-G01515D	S8JX-G01515C	S8JX-G01515CD
	25 V	0.65 A		S8JX-G01524	S8JX-G01524D	S8JX-G01524C	S8JX-G01524CD
35 W	5 V	7 A	96 x 39.5 x 114.5	S8JX-G03505	S8JX-G03505D	S8JX-G03505C	S8JX-G03505CD
	12 V	3 A		S8JX-G03512	S8JX-G03512D	S8JX-G03512C	S8JX-G03512CD
	15 V	2.4 A		S8JX-G03515	S8JX-G03515D	S8JX-G03515C	S8JX-G03515CD
	24 V	1.5 A		S8JX-G03524	S8JX-G03524D	S8JX-G03524C	S8JX-G03524CD
50 W	5 V	10 A	97 x 40 x 124.5	S8JX-G05005	S8JX-G05005D	S8JX-G05005C	S8JX-G05005CD
	12 V	4.2 A		S8JX-G05012	S8JX-G05012D	S8JX-G05012C	S8JX-G05012CD
	24 V	2.1 A		S8JX-G05024	S8JX-G05024D	S8JX-G05024C	S8JX-G05024CD
100 W	5 V	10 A	97 x 50 x 174.5	S8JX-G10005	S8JX-G10005D	S8JX-G10005C	S8JX-G10005CD
	12 V	8.5 A		S8JX-G10012	S8JX-G10012D	S8JX-G10012C	S8JX-G10012CD
	24 V	4.5 A		S8JX-G10024	S8JX-G10024D	S8JX-G10024C	S8JX-G10024CD
150 W	24 V	6.5 A	97 x 50 x 174.5	S8JX-G15024	S8JX-G15024D	S8JX-G15024C	S8JX-G15024CD
300 W	24 V	14 A	96 x 110 x 204.8	-	-	S8JX-G30024C	S8JX-G30024CD
600 W	24 V	27 A	92 x 150 x 184.2	-	-	S8JX-G60024C	-

\* Front mount models can also be side- or bottom-mounted. Front mounting bracket included. See datasheet for other optional mounting bracket details.

## Optional Mounting Brackets

Description	Part number
Mounting Bracket A (bottom mounting for 50 W models)	S82Y-JX05B
Mounting Bracket B (bottom mounting for 100 W: 24 V models)	S82Y-JX10B
Mounting Bracket C (bottom mounting for 100 W: 5 V and 12 V models and 150 W models)	S82Y-JX15B
Mounting Bracket D (front mounting for 100 W: 5 V and 12 V models and 150 W models)	S82Y-JX15F

## Compact 3-Phase Input Power Supply

Natural cooling 3-phase power supply provides greater reliability and eliminates ventilation fan as a potential source of failure.

- 3-phase input 340-576 VAC
- 5, 10, 20 and 40A models; 24 VDC output
- High stability, low ripple and noise level. Conforms to EN61000-3-2
- Efficiency: 86% to 91% (varies per model)
- Compact design and convection air cooled (no fans)
- Overload and overvoltage protection included
- Parallel and series operation possible
- RoHS compliant



## Ordering Information

Input voltage	Power rating	Output voltage	Output current	Model
340 to 576 VAC 3-phase	120 W	24 V	5 A	S8VT-F12024E
	240 W		10 A	S8VT-F24024E
	480 W		20 A	S8VT-F48024E
	960 W		40 A	S8VT-F96024E

# Power Supplies

---

Family	Section-Page	Family	Section-Page	Family	Section-Page
3G3JX	E-7	E2EQ	H-34	E4PA	M-2
3G3MX2	E-6	E2E-U DC 2-Wire	H-12	E5AN/E5EN	G-7
3G3RX	E-5	E2EV	H-37	E5AN-H/E5EN-H	G-8
61F	U-4	E2EY	H-38	E5AN-HT/E5EN-HT	G-9
A	R-10	E2EZ	H-38	E5AR/E5ER	G-17
A16	Q-10	E2F	H-30	E5C2	G-12
A165	Q-10	E2FM	H-31	E5CC	G-1
A165E	Q-11	E2FQ	H-35	E5CN	G-2
A165E	Q-11	E2K-C	H-28	E5CN-H	G-5
A165K	Q-13	E2K-F	H-29	E5CN-HT	G-6
A165L	Q-10	E2K-L	H-29	E5CN-L	G-3
A165S	Q-12	E2KQ-X	H-35	E5CN-U	G-4
A165W	Q-12	E2K-X	H-27	E5CSV	G-11
A16L	Q-10	E2Q5	H-26	E5GN	G-10
A22	Q-5	E2S	H-26	E5ZN	G-16
A22E	Q-6	E32 - Area Monitoring	J-10	E6A2-C	F-14
A22EL	Q-6	E32 - Chemical Resistant	J-5	E6B2-C	F-15
A22K	Q-8	E32 - Heat Resistant	J-6	E6C3-A	F-11
A22L	Q-5	E32 - Longer Distance	J-4	E6C3-C	F-16
A22R	Q-1	E32 - Miniature	J-3	E6CP-A	F-12
A22RK	Q-3	E32 - Precision Detection	J-9	E6D-C	F-17
A22RL	Q-1	E32 - Robot Application	J-8	E6F-A	F-13
A22RS	Q-2	E32 - Special Application	J-11	E6F-C	F-17
A22RW	Q-2	E32 - Square Shape	J-2	EE-SA701/EE-SA801	K-16
A22S	Q-7	E32 - Standard Cylindrical	J-1	EE-SPW311/EE-SPW411	K-12
A22W	Q-7	E32 - Vacuum Resistant	J-7	EE-SPW321/EE-SPW421	K-13
Accurax G5 Servo Drives	E-1	E39-L	I-23	EE-SPX301/EE-SPX401	K-7
Accurax G5 Servo Motors	E-3	E39-R	I-23	EE-SPX303N/EE-SPX403N	K-9
C200HW-MC402-E	F-6	E3C-LDA	L-11	EE-SPX613	K-14
CJ1W-MCH72/-MC472	F-3	E3F2	I-12	EE-SPX74□/EE-SPX84□	K-6
CJ1W-NC□□3	F-8	E3F2-□41	I-14	EE-SPX-W2A	K-8
CJ1W-NC□81/-NC□82	F-4	E3F2-□-S	I-13	EE-SPY301/EE-SPY302/EE-SPY401/	
CJ1W-NC271/-NC471/-NCF71	F-5	E3FR	I-11	EE-SPY402	K-7
CJ2-Series	A-10	E3FZ	I-11	EE-SPY31□/EE-SPY41□	K-10
CJ-Series I/O Units for NJ	A-6	E3G	I-15	EE-SPY801/EE-SPY802	K-17
CP1E	A-26	E3G-M	I-17	EE-SPZ-A	K-15
CP1H	A-24	E3JK	I-16	EE-SX47□/EE-SX67□	K-3
CP1L	A-25	E3JM	I-17	EE-SX77□/EE-SX87□	K-2
CPM2C	A-30	E3K	I-20	EE-SX91□	K-1
CP-Series Expansion Units	A-28	E3S-A	I-20	EE-SX97□	K-5
CRT1	C-5	E3S-C	I-22	EE-SY671/EE-SY672	K-11
CS1-Series	A-18	E3S-CL	I-15	EJ1	G-14
CS1/C200HW-MC402-E	F-6	E3S-LS3	I-18	ERT1	C-6
CS1W-MC421/-MC221	F-7	E3T	I-19	F3UV	I-21
CS1W-NC□□3/C200HW-NC□□	F-9	E3X-DAC-S	J-17	FJ	N-10
CX-One/CX-One Lite Software	D-2	E3X-DAH-S	J-17	FL Lighting & Accessories	N-13
D4A-N	R-2	E3X-DA-S	J-14	FQ	N-1
D4C	R-3	E3X-DA-SE-S	J-12	FQ-M	N-2
D4CC	R-4	E3X-CIF11	J-18	FZ/FJ Accessories	N-9
D4E-N	R-6	E3X-CRT	J-18	FZ/FJ Cameras	N-8
D4MC	R-6	E3X-DRT21	J-18	FZ4	N-6
D5B	R-8	E3X-DRT21S Ver3	J-18	FZ-LE/3Z4S-LE Lenses	N-14
DRT2 In-Panel	C-2	E3X-ECT	J-18	FZM1	N-12
DRT2 On-machine	C-4	E3X-HD	J-16	G2RS-S	P-2
DZ	R-13	E3X-MDA	J-15	G2RV	P-1
E2A DC 2-Wire	H-14	E3X-NA	J-13	G3MC	P-12
E2A DC 3-Wire	H-13	E3X-NA_F	J-15	G3NA	P-16
E2A DC 3-Wire Long-Barrel	H-21	E3X-SD	J-13	G3NE	P-17
E2A3 DC 3-Wire	H-16	E3Z	I-1	G3PA	P-19
E2AU DC-3 Wire	H-23	E3Z-B	I-7	G3PE	P-18
E2C-EDA	H-36, L-10	E3Z-G	I-7	G3PH	P-20
E2CY	H-37	E3Z-K	I-10	G3R	P-15
E2E AC 2-Wire	H-9	E3Z-L	I-8	G3RV	P-14
E2E DC 2-Wire	H-1	E3Z-L Laser	I-2	G3TB	P-13
E2E DC 3-Wire	H-5	E3Z-LS	I-9	G3ZA	G-15
E2E Miniature DC 3-Wire	H-11	E3ZM	I-3	G7J	P-8
E2E2 AC 2-Wire	H-20	E3ZM-B	I-6	G7L	P-9
E2E2 DC 2-Wire	H-17	E3ZM-C	I-4	G7TC/G70A/G70D	C-12
E2E2 DC 3-Wire	H-18	E3ZM-V	I-5	G7Z	P-11
E2EC	H-24	E4A-3K	M-1	GRT	C-1
E2EH	H-33	E4B	M-1	G-Series Servo Motors	E-4
E2EM DC 2-Wire	H-15	E4C	M-2	GX	C-7
		E4C-UDA	M-3	GX-JC	A-8



## Model Number Index

Family	Section-Page	Family	Section-Page
H3CA	S-2	SHL	R-7
H3CR	S-3	SmartStep 2 Servo Drives	E-2
H3DK	S-5	Sysmac NJ-Series	A-1
H3DS	S-6	Sysmac Studio Software	A-7, D-1
H3JA	S-4	TCS1400	O-5
H3YN	S-4	TCS1490	O-5
H5CX-N	S-1	TJ1-MC04/-MC16	F-2
H5F	S-8	TJ2-MC04/-MC64	F-2
H5L	S-8	TL-W	H-25
H5S	S-7	TZ	R-12
H7BX	T-3	V400-F	O-7
H7CN	T-3	V400-H	O-6
H7CX-N	T-1	V400-R	O-8
H7EC	T-2	V640	O-11
H7ER	T-2	V680 Series	O-9
H7ET	T-2	V680-HAM42-DRT	O-10
H8PS	F-10	V680-HAM91/-HAM81	O-10
HS1/HS2D	O-4	V750	O-12
K3GN	U-3	VB	R-8
K3HB-C	U-2	WE70	C-9
K3HB-H	U-1	WL	R-1
K3HB-P	U-2	X	R-11
K3HB-R	U-2	XS2F-M12	H-39
K3HB-S	U-1	XS3F-M8	H-41
K3HB-V	U-1	XS5	A-9
K3HB-X	U-1	XS6	A-9
K3MA-F	U-3	XW2	C-10
K3MA-J	U-3	Z	R-9
K3MA-L	U-3	ZE	R-5
K7L-AT50	U-6	ZEN	A-31
K7L-UP-FLK	U-5	ZFV-C	N-3
K8AB-AS	P-21	ZFX	N-4
K8AB-P	P-22	ZG2	L-1
K8AB-TH	G-13	ZS-HL	L-3
K8AB-V	P-23	ZS-L	L-2
LY	P-4	ZV	R-5
M16	Q-14	ZV2	R-5
M165	Q-14	ZX1	L-5
M22	Q-9	ZX2	L-6
M22R	Q-4	ZX-E	L-8
M2BJ	Q-15	ZX-GT	L-7
MGN	P-10	ZX-L-N	L-4
MJN	P-7	ZX-T	L-9
MKS	P-5		
MKS-X	P-6		
MobileHawk	O-4		
MS Quadrus™ Family	O-3		
MS-3	O-1		
MX2	E-6		
MY	P-3		
NB	B-4		
NJ3, NJ5	A-5, F-1		
NS	B-1		
NSA	B-8		
NSJ	B-2		
NSR	B-9		
NT11	B-6		
NT2S	B-7		
NV3/NV4	B-5		
QX830	O-1		
QX870	O-2		
R7D□-B SmartStep 2	E-2		
R88D-KN□□□-ECT Accurax G5	E-1		
R88D-KN□□□-ML2 Accurax G5	E-1		
R88D-KT□ Accurax G5	E-1		
R88M-G□	E-4		
R88M-K□□□	E-3		
S8JX	V-4		
S8VE	V-2		
S8VM	V-3		
S8VS	V-1		
S8VT-F	V-5		
SCADA Software	D-4		

## NEMA Ratings

NEMA (National Electrical Manufacturers Association) ratings ensure protection against the following environmental conditions.

Environmental Conditions	Type of Enclosure													
	1	2	3	3R	3S	4	4X	5	6	6P	11	12	12K	13
Accidental contact with the enclosed equipment	X	X	X	X	X	X	X	X	X	X	X	X	X	X
Falling dirt	X	X	--	--	--	X	X	X	X	X	X	X	X	X
Falling liquids, light splashing	--	X	--	--	--	X	X	--	X	X	X	X	X	X
Dust, lint, fibers and flyings (non-combustible, non-ignitable)	--	--	--	--	--	X	X	X	X	X	--	X	X	X
Windblown dust	--	--	X	--	X	X	X	--	X	X	--	--	--	--
Hosedown and splashing water	--	--	--	--	--	X	X	--	X	X	--	--	--	--
Oil and coolant seepage	--	--	--	--	--	--	--	--	--	--	--	X	X	X
Oil or coolant spraying and splashing	--	--	--	--	--	--	--	--	--	--	--	--	--	X
Corrosive agents	--	--	--	--	--	--	X	--	--	X	X	--	--	--
Occasional temporary submersion	--	--	--	--	--	--	--	--	X	X	--	--	--	--
Occasional prolonged submersion	--	--	--	--	--	--	--	--	--	X	--	--	--	--

## IP Ratings

The IEC (International Electrotechnical Commission) defines degrees of protection provided by electrical enclosures with respect to personnel, equipment within the enclosure and ingress of water. The degree of protection is expressed by the letters "IP" followed by two numerals (Example: IP67). See the table below for an explanation of the numerals.

The following information is drawn from publication IEC 60529 of 2004 and 529 of 1989.

By contrast to NEMA, "IP" ratings do not apply to protection against the risk of explosion or conditions such as humidity, corrosive gases, fungi or vermin. Also, different parts of a piece of equipment can have different degrees of protection and still comply with the standards. An example would be the opening in the base of an enclosure.

1st characteristic numeral		2nd characteristic numeral	
Protection against contact and penetration of solid bodies.		Protection against the penetration of liquids.	
0	Not protected	0	Not protected
1	Protection against solid objects greater than 50 mm	1	Protection against dripping water
2	Protection against solid objects greater than 12 mm	2	Protection against dripping water when tilted up to 15°
3	Protection against solid objects greater than 2.5 mm	3	Protection against spraying water
4	Protection against solid objects greater than 1 mm	4	Protection against splashing water
5	Dust protected	5	Protection against water jets
6	Dust tight	6	Protection against heavy seas
--		7	Protection against the effects of immersion
--		8	Protection against submersion
--		9K	Protection against steam jet cleaning

## WORKING FOR THE BENEFIT OF SOCIETY

Our approach to product development and business is guided by core values based on serving the needs of society. This is reflected in the Omron corporate motto...

**“At work for a better life, a better world for all.”**

Conceived by Omron’s founder Kazuma Tateisi, these words reflect his pioneering idea that a company should fulfill its responsibility to society rather than solely focusing on productivity, efficiency, sales and profits. Our unending commitment to identifying social needs is embedded in Omron’s corporate DNA, along with a challenge-oriented spirit capable of responding to those needs.

The Omron Foundation in the Americas funds charitable donations for disaster relief and recovery efforts, and matches individual employee donations to social support, education, and cultural enrichment organizations. Each year on May 10, Omron employees around the world actively participate in charitable activities to honor the core values established by the company’s founder. Throughout the year, Omron offers team and individual opportunities at partner charitable organizations to underscore the need for social responsibility as a corporate priority.



### ENVIRONMENTAL PROTECTION

Providing environmentally safe products to the world.

Omron’s social responsibility also takes the form of decisions and actions that help preserve and restore the environment. Far in advance of directives banning the use of harmful chemicals in making electronics (RoHS), Omron adopted an ECO policy that works to eliminate these and other pollutants. The policy also mandates significant reductions in power consumption to conserve energy and natural resources for future generations.



***When you choose an automation supplier,  
choose Omron Automation and Safety—  
the one that works for the benefit of society.***

## OMRON AUTOMATION AND SAFETY • THE AMERICAS HEADQUARTERS

Schaumburg, IL USA • 847.843.7900 • 800.556.6766 • www.omron247.com

### OMRON CANADA, INC. • HEAD OFFICE

Toronto, ON, Canada • 416.286.6465 • 866.986.6766 • www.omron247.com

### OMRON ELECTRONICS DE MEXICO • HEAD OFFICE

México DF • 52.55.59.01.43.00 • 001.800.556.6766 • mela@omron.com

### OMRON ELECTRONICS DE MEXICO • SALES OFFICE

Apodaca, N.L. • 52.81.11.56.99.20 • 001.800.556.6766 • mela@omron.com

### OMRON ELETRÔNICA DO BRASIL LTDA • HEAD OFFICE

São Paulo, SP, Brasil • 55.11.2101.6300 • www.omron.com.br

### OMRON ARGENTINA • SALES OFFICE

Cono Sur • 54.11.4783.5300

### OMRON CHILE • SALES OFFICE

Santiago • 56.9.9917.3920

### OTHER OMRON LATIN AMERICA SALES

54.11.4783.5300

## OMRON EUROPE B.V. • Wegalaan 67-69, NL-2132 JD, Hoofddorp, The Netherlands.

+31 (0) 23 568 13 00 • www.industrial.omron.eu

### *Authorized Distributor:*

#### **Automation Control Systems**

- Machine Automation Controllers (MAC) • Programmable Controllers (PLC)
- Operator interfaces (HMI) • Distributed I/O • Software

#### **Drives & Motion Controls**

- Servo & AC Drives • Motion Controllers & Encoders

#### **Temperature & Process Controllers**

- Single and Multi-loop Controllers

#### **Sensors & Vision**

- Proximity Sensors • Photoelectric Sensors • Fiber-Optic Sensors
- Amplified Photomicrosensors • Measurement Sensors
- Ultrasonic Sensors • Vision Sensors

#### **Industrial Components**

- RFID/Code Readers • Relays • Pushbuttons & Indicators
- Limit and Basic Switches • Timers • Counters • Metering Devices
- Power Supplies

#### **Safety**

- Laser Scanners • Safety Mats • Edges and Bumpers • Programmable Safety Controllers • Light Curtains • Safety Relays • Safety Interlock Switches

# Mouser Electronics

Authorized Distributor

Click to View Pricing, Inventory, Delivery & Lifecycle Information:

[Omron:](#)

[C200H-CN229-EU](#)