

# RJ45 Single Port 10GBase-T Magnetic Module

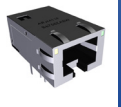

ARJM11F - B6755ZAEWCB

28.5 x 17.6 x 12.0 mm  
RoHS/RoHS II Compliant  
MSL = 1

## Features

- Single Port - 5 channel RJ45 with Magnetics
- Supports speed up to 10 Gbps
- Operating temperature range up to 0°C to +70°C
- Different Gold plating options
- Compatible with major IC's for Ethernet applications
- High performance magnetics for EMI suppression and common mode noise rejection
- 1CT:1CT TX and RX Transformers

## Applications

- Fast and gigabit Ethernet
- Hubs, Servers, Switches, Routers, Access points
- IP cameras, surveillance, and phone
- Industrial computers and robotics
- Networking and communications
- Broadcast video
- Set top box
- Test and Measurement

## Electrical Specifications

Parameters	Minimum	Typical	Maximum	Units	Notes
Inductance	150			μH	100 kHz, 0.1V with 0 mA DC Bias
Leakage Inductance			0.4	μH	100 kHz, 0.1V
DC Resistance			1.0	Ω	
Hi-pot	2250			VDC	60 s
Insertion Loss			3.0	dB	0.1-1 MHz
			2.0		1-400 MHz
Return Loss	22			dB	1-100 MHz
	$22-20.75\log(f^*/100)$				100-500 MHz
Crosstalk	28			dB	1-100 MHz
	19				100-500 MHz
CMR	30			dB	1-100 MHz
	26				100-500 MHz
DCR	30			dB	1-250MHz
	22				250-500 MHz

\*f represents the test frequency specified in MHz

# RJ45 Single Port 10GBase-T Magnetic Module

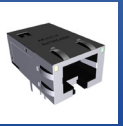

ARJM11F - B6755ZAEWCB

28.5 x 17.6 x 12.0 mm  
RoHS/RoHS II Compliant  
MSL = 1

## Material Specifications

Parameter	Specification	
Housing	Material	Glass Filled PA46, Black
	Flammability Rating	UL94V-0 (RoHS)
Contact	Material	Phosphor Bronze, 50-100 u" (min)
	Plating (1)	Nickel
	Plating (2)	50 u" Gold*
Shield	Material	Copper Alloy, 0.2mm
Jack Cavity	In conformance with the FCC Rules and Regulations Part 68 Subpart F	
Turns Ratio	1 CT : 1 CT ( $\pm 2\%$ )	

\*For alternative Gold plating thickness, please contact ABRACON.

## Environmental Specifications

Parameters	Specification
RoHS	RoHS Compliant
MSL	1
Operating Temperature	0 °C to +70 °C
Storage Temperature	-40 °C to +85 °C

# RJ45 Single Port 10GBase-T Magnetic Module

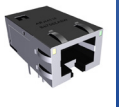

ARJM11F - B6755ZAEWCB

28.5 x 17.6 x 12.0 mm  
RoHS/RoHS II Compliant  
MSL = 1

## Mechanical Dimensions

W Shield, W EMI Fingers, Tab Down

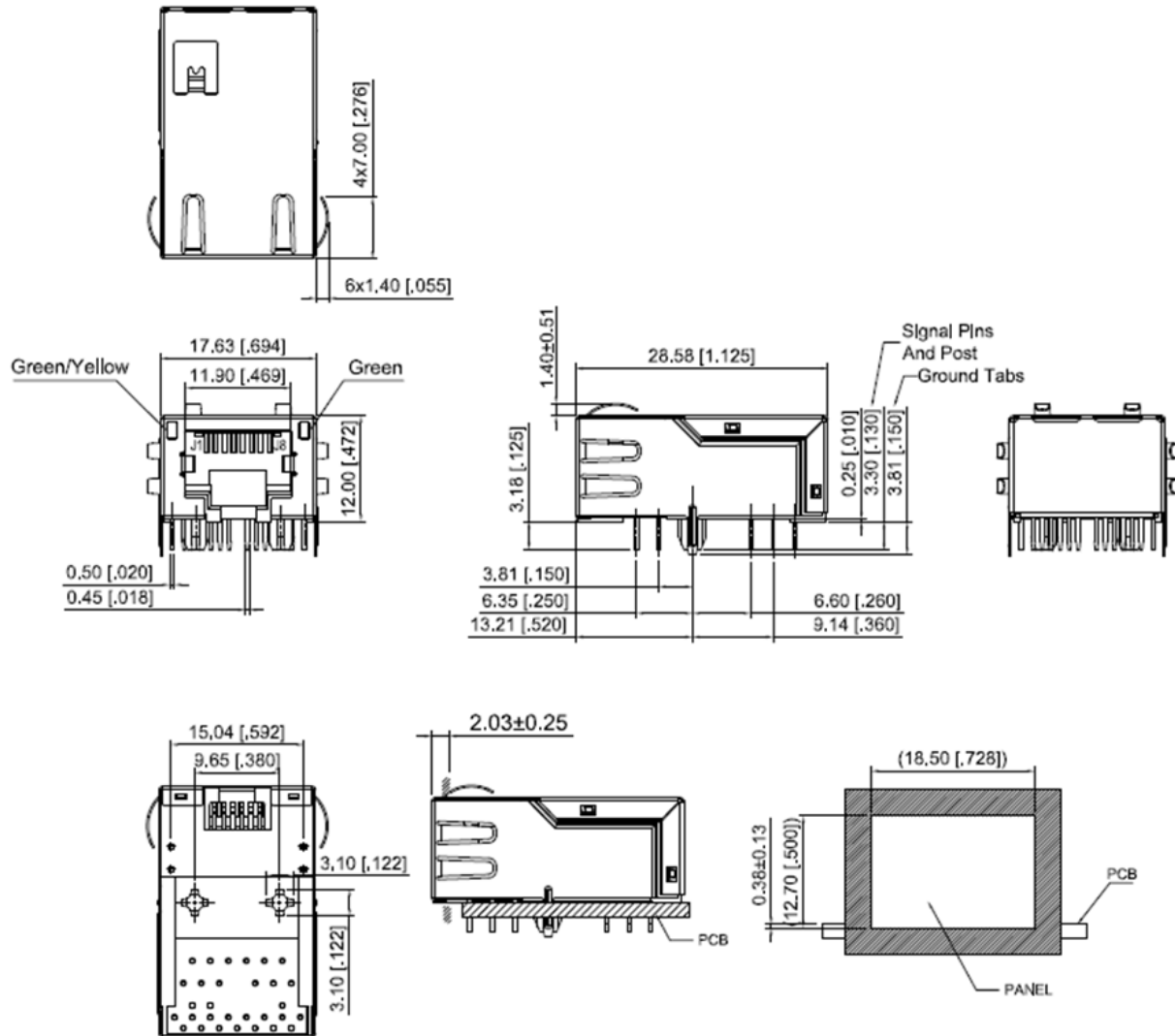

Dimensions: mm[inch]  
(Unless otherwise specified, all tolerances are ±0.25[0.010])

# RJ45 Single Port 10GBase-T Magnetic Module

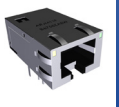

ARJM11F - B6755ZAEWCB

28.5 x 17.6 x 12.0 mm  
RoHS/RoHS II Compliant  
MSL = 1

## Mechanical Dimensions

### Pin Layout

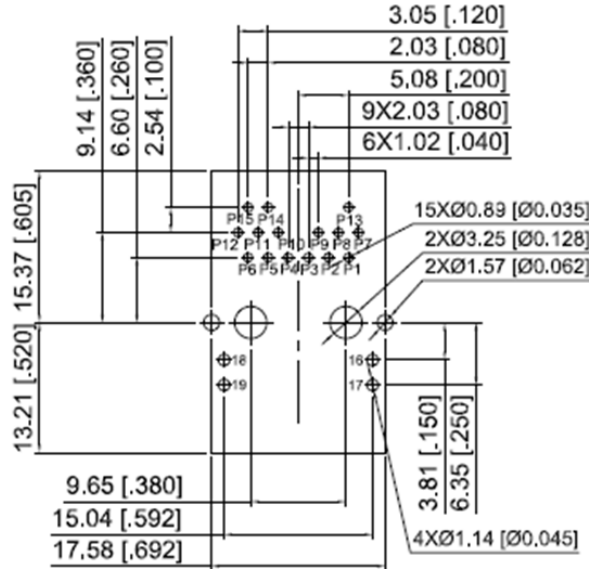

Dimensions: mm[inch]  
(Unless otherwise specified, all tolerances are  $\pm 0.05$ [0.002])

## Schematic

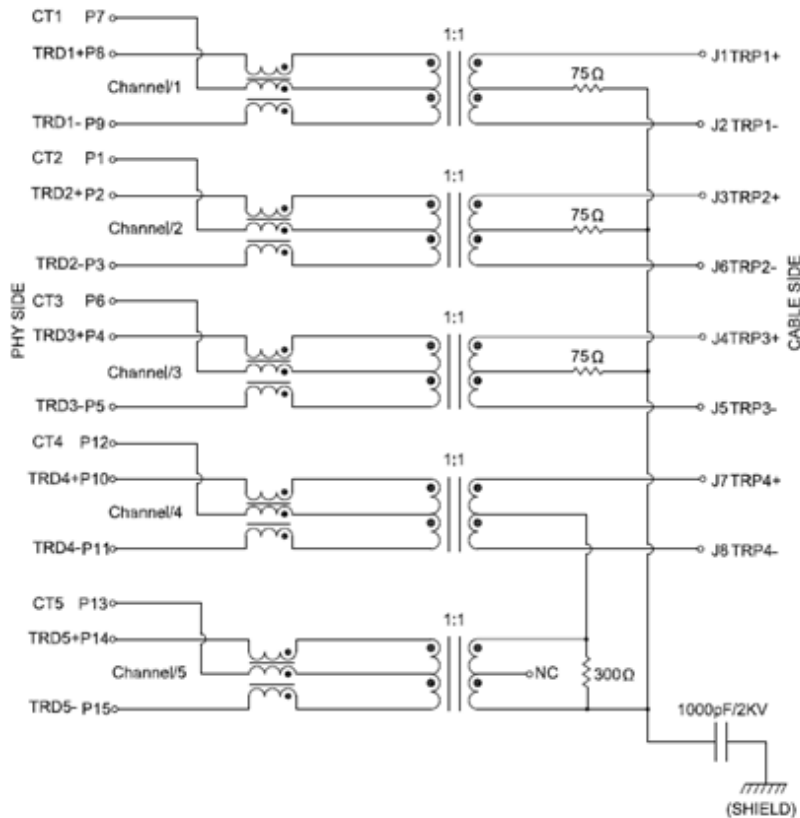

# RJ45 Single Port 10GBase-T Magnetic Module



ARJM11F - B6755ZAEWCB

28.5 x 17.6 x 12.0 mm  
RoHS/RoHS II Compliant  
MSL = 1

## LED Specification. @ 20mA Forward Current

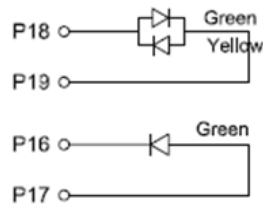

LED Color	Wavelength	Forward Voltage	
		Typ.	Max.
Green	565 nm	2.2 V	2.4 V
Yellow	590 nm	2.1 V	2.5 V

\*For alternative LED colors, please contact ABRACON.

## Wave Soldering Profile

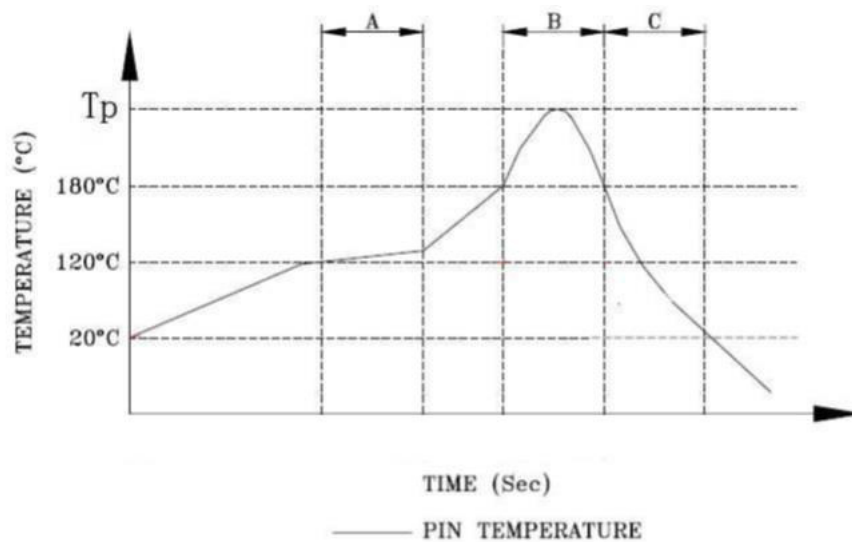

A. Preheating B. Soldering C. Gradual Cooling

Peak Temperature (Tp) = 265 °C ± 5 °C (max)

Peak Time (tp) = 10 s (max)

# RJ45 Single Port 10GBase-T Magnetic Module

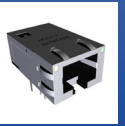

ARJM11F - B6755ZAEWCB

28.5 x 17.6 x 12.0 mm  
RoHS/RoHS II Compliant  
MSL = 1

## Packaging

---

Pieces per Carton: 650

Bulk/Tray per Carton: 50

Pieces per Bulk/Tray: 8 Kg

Dimension of the Carton: 370 x 250 x 275 mm

**ATTENTION:** Abracon LLC's products are COTS – Commercial-Off-The-Shelf products; suitable for Commercial, Industrial and, where designated, Automotive Applications. Abracon's products are not specifically designed for Military, Aviation, Aerospace, Life-dependent Medical applications or any application requiring high reliability where component failure could result in loss of life and/or property. For applications requiring high reliability and/or presenting an extreme operating environment, written consent and authorization from Abracon LLC is required. Please contact Abracon LLC for more information.



5101 Hidden Creek Ln Spicewood TX 78669  
Phone: 512-371-6159 | Fax: 512-351-8858  
For terms and conditions of sales, please visit:  
[www.abracon.com](http://www.abracon.com)

REVISED: 10.30.2019

ABRACON IS  
ISO9001-2015  
CERTIFIED

# Mouser Electronics

Authorized Distributor

Click to View Pricing, Inventory, Delivery & Lifecycle Information:

[ABRACON:](#)

[ARJM11F-B6755ZAEWCB](#)