













DESCRIPTION: B SIZE CIRCULAR // FEMALE CABLE MOLDED // BAYONET

SPECIFICATIONS:

MATERIALS:
 HOUSING: PA66, UL94 V-0, BLACK
 CONTACTS: GOLD FLASH PLATED BRASS
 NUT: PA66, UL94 V-0, BLACK
 ORING: SILICONE

ELECTRICAL:
 RATED CURRENT: SEE TABLE TO LEFT
 RATED VOLTAGE: 250V
 INSULATION RESISTANCE: 100 MOhms MIN.
 CONTACT RESISTANCE: 10 mOhms MAX.

ENVIRONMENT:
 OPERATING TEMPERATURE: -40°C TO +105°C
 WATER PROOF: IP67

POSITIONS AVAILABLE				
NorComp Part Number	POSITIONS		MAX AMPERAGE	MAX WIRE AWG
868-02A-203R001	2A		10A	18AWG
868-03A-203R001	3A		10A	18AWG
868-04A-203R001	4A		10A	18AWG
868-02B-203R001	2B		5A	24AWG
868-03B-203R001	3B		5A	24AWG
868-04B-203R001	4B		5A	24AWG
868-005-203R001	5		5A	24AWG
868-006-203R001	6		5A	24AWG
868-007-203R001	7		5A	24AWG
868-008-203R001	8		5A	24AWG
868-010-203R001	10		2A	26AWG
868-012-203R001	12		2A	26AWG

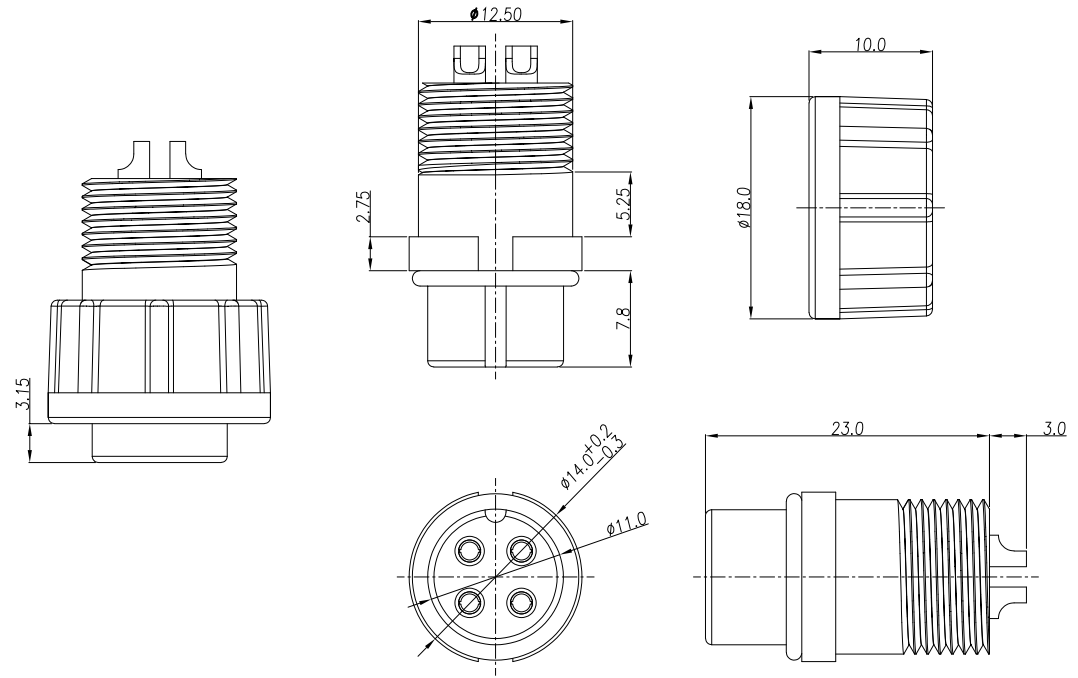

RoHS COMPLIANT



THESE DRAWINGS AND SPECIFICATIONS ARE THE PROPERTY OF NorComp AND SHALL NOT BE REPRODUCED, COPIED OR USED AS THE BASIS FOR THE MANUFACTURE OR SALE OF APPARATUS WITHOUT WRITTEN PERMISSION.

DRAWN: J. KADEL
 DATE: 06/17/2024

UNITS = mm

DO NOT SCALE FROM DRAWING



SCALE: NTS	SHEET 1 OF 1	REV 0
DWG NO. 868-YYY-203R001		

Mouser Electronics

Authorized Distributor

Click to View Pricing, Inventory, Delivery & Lifecycle Information:

[NorComp:](#)

[868-04A-203R001](#) [868-007-203R001](#) [868-010-203R001](#) [868-03B-203R001](#) [868-04B-203R001](#) [868-03A-203R001](#)
[868-008-203R001](#) [868-02A-203R001](#) [868-012-203R001](#) [868-005-203R001](#) [868-02B-203R001](#) [868-006-203R001](#)