

SPECIFICATIONS:

ELECTRICAL:

INSULATOR RESISTANCE: 5 GΩ MIN.
 WORKING VOLTAGE: 250V
 OPERATING TEMPERATURE: -55°C TO +125°C
 POWER CONTACT RESISTANCE: 1.0 mΩ MAX.
 POWER CONTACT AMPERAGE: SEE P/N KEY

MECHANICAL:

CONTACT INSERTION FORCE: 4.5 Kg MAX.
 CONTACT SEPARATION FORCE: 0.3 Kg MIN.

MATERIALS:

CONTACTS: COPPER ALLOY, GOLD FLASH
 INSULATOR: PBT UL94V-0 RATED
 230°C PROCESS TEMP.
 SHELL: NICKEL PLATED STEEL
 BRACKET: NICKEL PLATED STEEL
 BOARD LOCK: NICKEL PLATED BRASS
 SEAL: F08 FLEXIBLE ADHESIVE

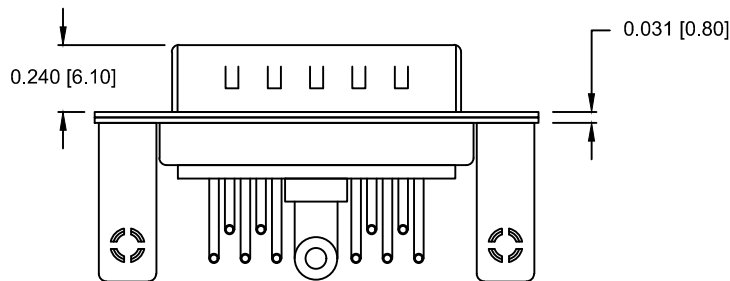
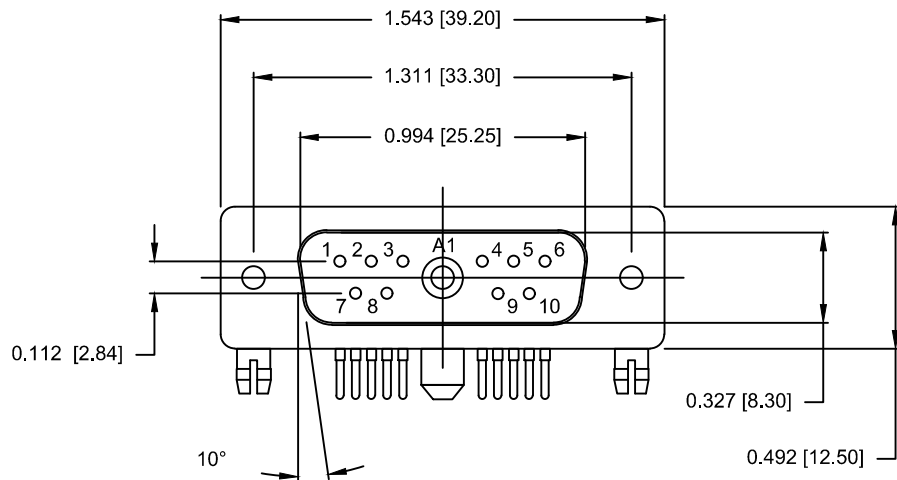

SEE SHEET 2
 FOR CONTACT & BRACKET DIMENSION DETAILS

MEETS IP67 STANDARDS

(SEE PAGE 3 FOR SEALING DETAILS)

684S11W1103LYYY

00 = 40 AMP POWER // NO BRACKET // STANDARD PCB TAILS
 46 = 40 AMP POWER // #4-40 BRACKET // STANDARD PCB TAILS
 62 = 40 AMP POWER // #4-40 BRACKET // 2.22mm PCB TAILS

1 = GOLD FLASH

RoHS COMPLIANT

UNITS = inches [mm]

DO NOT SCALE FROM DRAWING



THESE DRAWINGS AND SPECIFICATIONS ARE THE PROPERTY OF NorComp AND SHALL NOT BE REPRODUCED, COPIED OR USED AS THE BASIS FOR THE MANUFACTURE OR SALE OF APPARATUS WITHOUT WRITTEN PERMISSION.

DRAWN:
 M. SIGMON

DATE:
 06/11/2013

NorComp

SCALE:
 NTS

SHEET 1 OF 3

REV 2

DWG NO.

684S11W1103L461

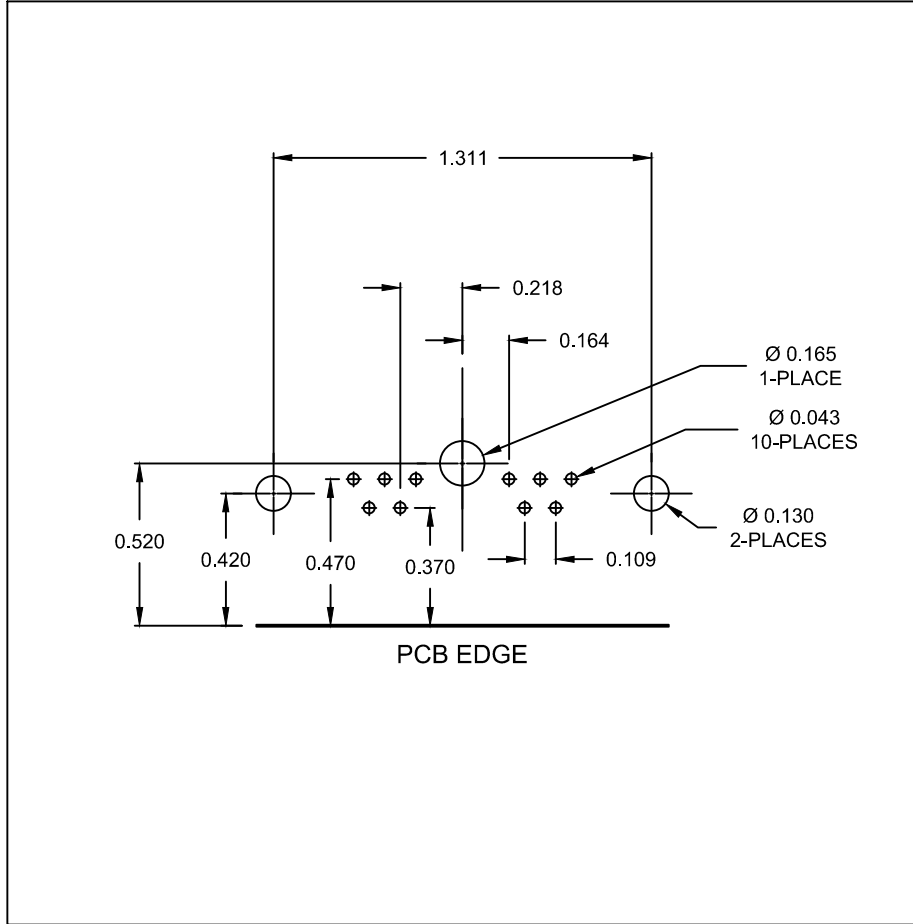

RIGHT ANGLE BRACKET

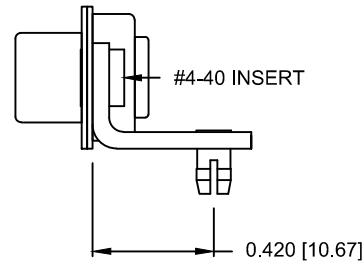

DIMENSIONS(in/mm)		
OPTION	S	P
46	0.146	0.185
	3.70	4.70
62	0.087	0.087
	2.22	2.22

SIGNAL CONTACTS

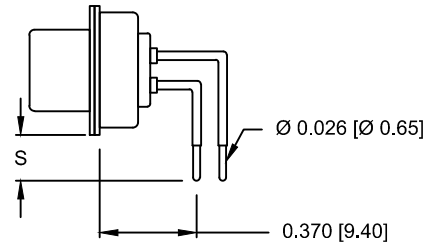

POWER CONTACTS

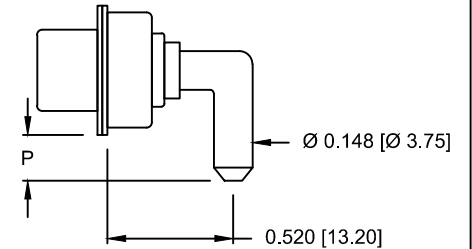

RoHS COMPLIANT

UNITS = inches [mm]

DO NOT SCALE FROM DRAWING



THESE DRAWINGS AND SPECIFICATIONS ARE THE PROPERTY OF NorComp AND SHALL NOT BE REPRODUCED, COPIED OR USED AS THE BASIS FOR THE MANUFACTURE OR SALE OF APPARATUS WITHOUT WRITTEN PERMISSION.

DRAWN:
M. SIGMON

DATE:
06/11/2013

NorComp

SCALE:
NTS

SHEET 2 OF 3

REV 2

DWG NO.

684S11W1103L461

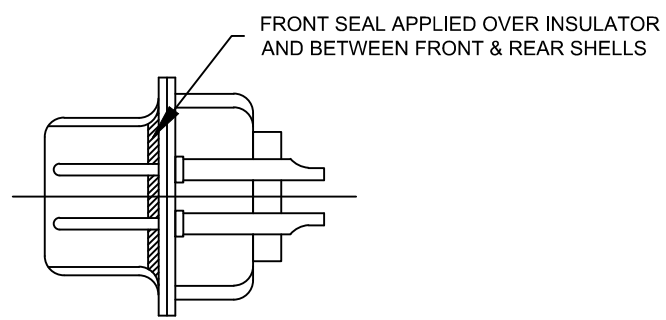
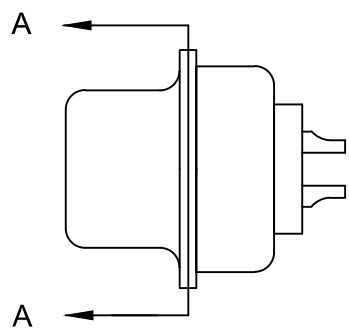

DETAIL A-A
SHOWN FOR REFERENCE ONLY

RoHS COMPLIANT

UNITS = inches [mm] DO NOT SCALE FROM DRAWING

	THESE DRAWINGS AND SPECIFICATIONS ARE THE PROPERTY OF NorComp AND SHALL NOT BE REPRODUCED, COPIED OR USED AS THE BASIS FOR THE MANUFACTURE OR SALE OF APPARATUS WITHOUT WRITTEN PERMISSION.	DRAWN: M. SIGMON
		DATE: 06/11/2013

NorComp

SCALE: NTS	SHEET 3 OF 3	REV 2
DWG NO. 684S11W1103L461		

Mouser Electronics

Authorized Distributor

Click to View Pricing, Inventory, Delivery & Lifecycle Information:

[NorComp:](#)

[684S11W1103L461](#)