

DESCRIPTION: POWER / SIGNAL - VERTICAL BOARD - FEMALE

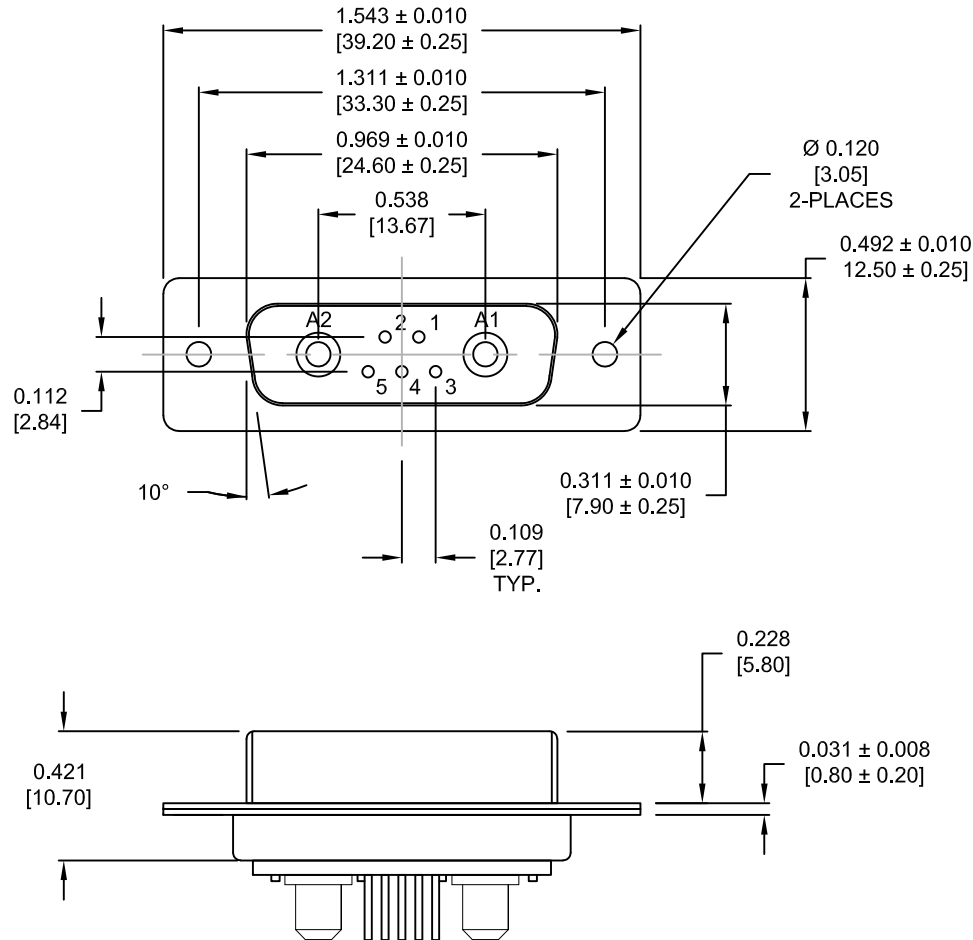

**SPECIFICATIONS:**

**ELECTRICAL:**

INSULATOR RESISTANCE: 5 G OHMS Min.  
 DIELECTRIC WITHSTANDING: 1,000VAC r.m.s.  
 OPERATING TEMPERATURE: -55° C ~ +125° C  
 POWER CONTACT RESISTANCE: 1.0 mOHMS Max.  
 SIGNAL CONTACT RESISTANCE: 10 mOHMS Max.  
 POWER PINS: 40 AMPS  
 SIGNAL PINS: 5 AMPS

**MECHANICAL:**

CONTACT INSERTION FORCE: 4.5 Kg Max.  
 CONTACT SEPARATOR FORCE: 0.3Kg Min.

**MATERIALS:**

CONTACTS: COPPER ALLOY  
 INSULATOR: PBT UL94V-0 RATED, BLK  
 230°C PROCESS TEMP.  
 SHELL: STEEL  
 SEAL: F04 FLEXIBLE ADHESIVE

**FINISH:**

SHELL: NICKEL  
 CONTACTS: FULL GOLD FLASH

**681S7W2203LYYY**

0 = 40 AMP  
 0 = NO HARDWARE  
 4 = 0.237" BOARDLOCK PCB SIDE  
 1 = GOLD FLASH

**MEETS IP67 STANDARDS**

(SEE PAGE 2 FOR SEALING DETAILS)

**RoHS COMPLIANT**

UNITS = INCHES [MM] **DO NOT SCALE FROM DRAWING**



THESE DRAWINGS AND SPECIFICATIONS ARE THE PROPERTY OF NorComp AND SHALL NOT BE REPRODUCED, COPIED OR USED AS THE BASIS FOR THE MANUFACTURE OR SALE OF APPARATUS WITHOUT WRITTEN PERMISSION.

DRAWN: P. JENKINS  
 DATE: 07/19/2011

**NorComp**

SCALE: NTS	SHEET 1	OF 3	REV 2
<b>681S7W2203LYYY</b>			

DESCRIPTION: 681 SERIES CONTACTS

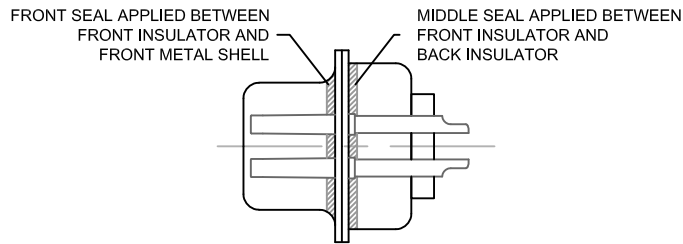
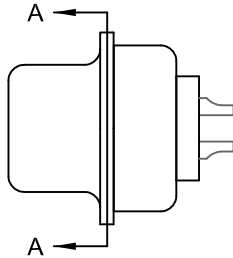

DETAIL A-A  
SHOWN FOR REFERENCE ONLY

NOTE: SIGNAL AND POWER CONTACTS  
COME PRE-LOADED INTO INSULATORS

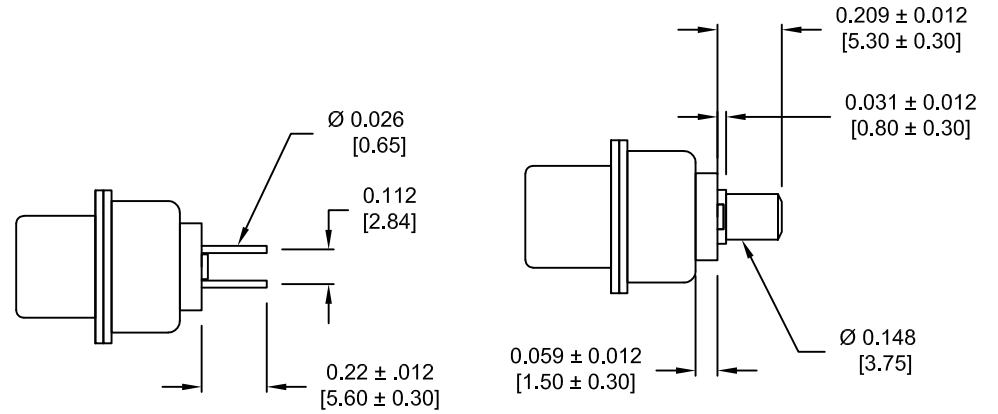

SIGNAL CONTACTS

POWER CONTACTS

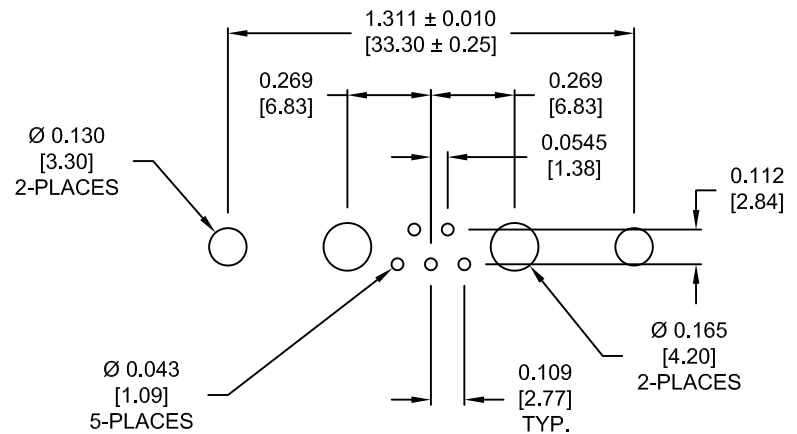

RECOMMENDED PCB LAYOUT  
(TOLERANCE  $\pm 0.002$  [0.05])

RoHS COMPLIANT

UNITS = INCHES [MM] DO NOT SCALE FROM DRAWING



THESE DRAWINGS AND SPECIFICATIONS ARE THE PROPERTY OF NorComp AND SHALL NOT BE REPRODUCED, COPIED OR USED AS THE BASIS FOR THE MANUFACTURE OR SALE OF APPARATUS WITHOUT WRITTEN PERMISSION.

DRAWN:  
P. JENKINS  
DATE:  
07/19/2011

NorComp

SCALE: NTS	SHEET 2	OF 3	REV 2
681S7W2203LYYY			

DESCRIPTION: CLINCH NUT HARDWARE

ALL CLINCH-NUTS ARE 4-40 INTERNAL THREADS

TOLERANCE:  
ALL DIMENSIONS ARE  $\pm 0.010$

0 ..... NO HARDWARE

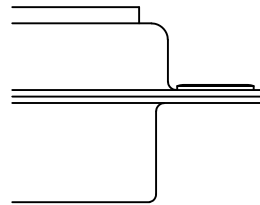

4 ..... 0.237" PCB SIDE

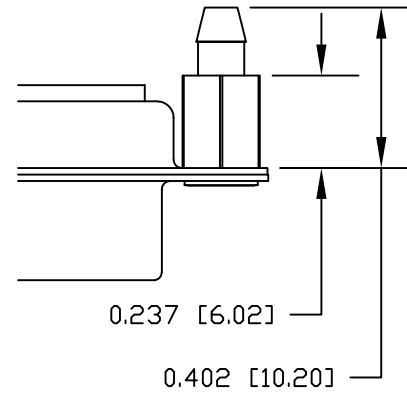

RoHS COMPLIANT

UNITS = INCHES [MM] DO NOT SCALE FROM DRAWING



THESE DRAWINGS AND SPECIFICATIONS ARE THE PROPERTY OF NorComp AND SHALL NOT BE REPRODUCED, COPIED OR USED AS THE BASIS FOR THE MANUFACTURE OR SALE OF APPARATUS WITHOUT WRITTEN PERMISSION.

DRAWN:  
P. JENKINS

DATE:  
07/19/2011

NorComp

SCALE:  
NTS

SHEET OF  
3 3

REV  
2

681S7W2203LYYY

# Mouser Electronics

Authorized Distributor

Click to View Pricing, Inventory, Delivery & Lifecycle Information:

[NorComp:](#)

[681S7W2203L001](#)