

Switching Regulator IC for Buck Converter

Current Mode Control w/ 40V/8A MOSFET

■ GENERAL DESCRIPTION

The **NJW4158** is a current mode controlled buck converter with **40V/8A MOSFET** that operates wide input range from 6V to 35V. The **NJW4158** can realize a buck converter with minimal external components that it includes compensation circuit.

The **NJW4158** is able to stable startup by soft start function. Also, it has over current protection and thermal shutdown circuit.

It is suitable for supplying power to an Office Automation Equipment, Industrial Instrument, Amusement, Wireless Base Station Applications and so on.

■ PACKAGE OUTLINE

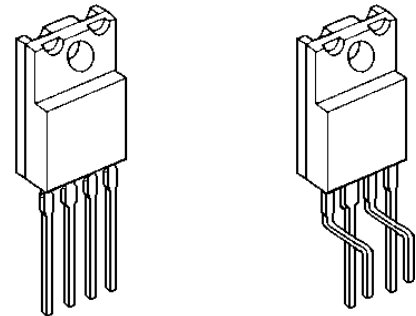

1 2 3 4

NJW4158F

NJW4158FL

PIN CONFIGURATION

1. V⁺
2. SW
3. GND
4. IN-

■ FEATURES

- Current Mode Control
- Wide Input Range: 6V to 40V
- Switching Current 10.5A min.
- PWM Control
- Built-in Compensation Circuit
- Oscillating Frequency: 150kHz typ.
- Soft Start Function 10ms typ.
- UVLO (Under Voltage Lockout)
- Over Current Protection
- Thermal Shutdown Function
- Package Outline TO-220F-4pin

■ BLOCK DIAGRAM

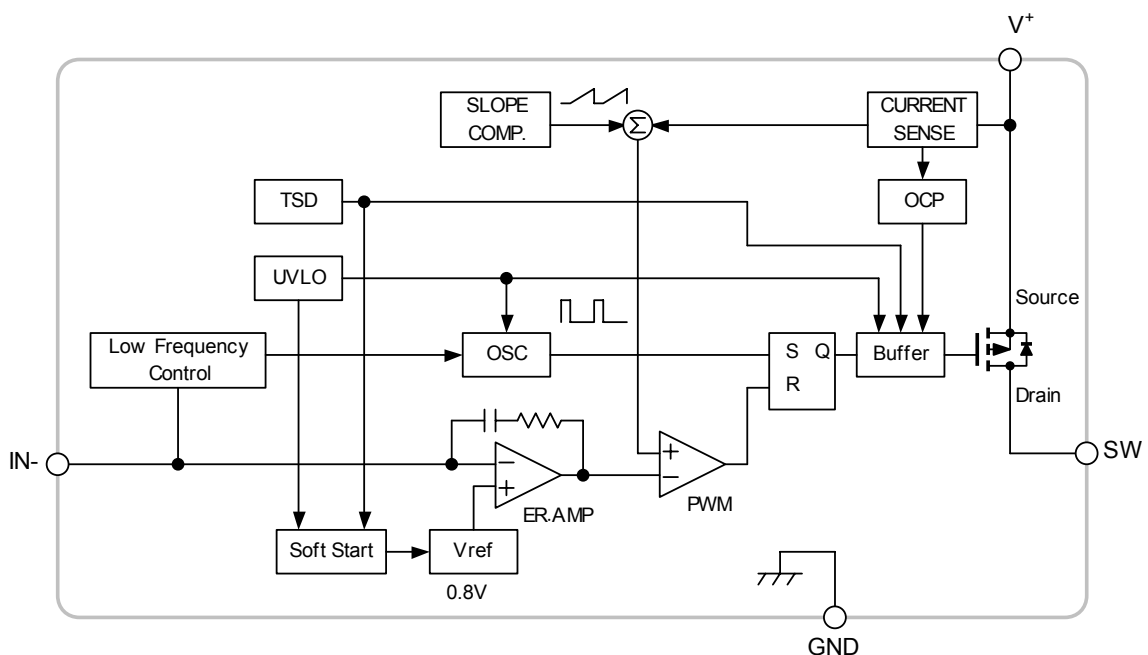

■ ABSOLUTE MAXIMUM RATINGS

(Ta=25°C)

PARAMETER	SYMBOL	MAXIMUM RATINGS	UNIT
Supply Voltage	V ⁺	+45	V
Drain – Source pin Voltage	V _{DSS}	-50	V
IN- pin Voltage	V _{IN-}	-0.3 to +6	V
Power Dissipation	P _D	2.1 (Device itself)	W
Junction Temperature Range	T _j	-40 to +150	°C
Operating Temperature Range	T _{opr}	-40 to +85	°C
Storage Temperature Range	T _{stg}	-40 to +150	°C

■ RECOMMENDED OPERATING CONDITIONS

PARAMETER	SYMBOL	MIN.	TYP.	MAX.	UNIT
Supply Voltage	V ⁺	6	12	40	V
IN- pin Voltage	V _{IN-}	0	-	5.5	V

■ THERMAL CHARACTERISTICS

PARAMETER	SYMBOL	THERMAL RESISTANCE	UNIT
Junction-to-Ambient Temperature	θ _{ja}	59.5	°C/W
Junction-to-Case	ψ _{jt}	7.5	°C/W

■ POWER DISSIPATION vs. AMBIENT TEMPERATURE

Power Dissipation vs. Ambient Temperature

(T_j = ~150°C)

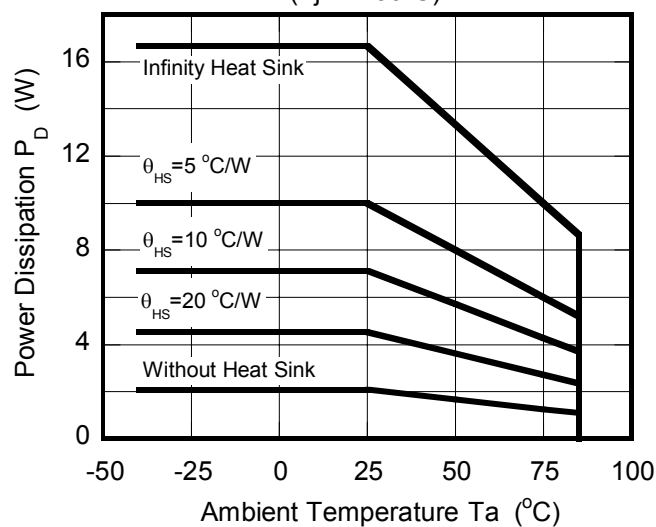

■ ELECTRICAL CHARACTERISTICS

(Unless otherwise noted, $V^+=12V$, $T_a=25^\circ C$)

PARAMETER	SYMBOL	TEST CONDITION	MIN.	TYP.	MAX.	UNIT
Under Voltage Lockout Block						
ON Threshold Voltage	V_{T_ON}	$V^+=L \rightarrow H$	5.2	5.4	5.6	V
OFF Threshold Voltage	V_{T_OFF}	$V^+=H \rightarrow L$	4.4	4.6	4.8	V
Hysteresis Voltage	V_{HYS}		400	800	–	mV
Soft Start Block						
Soft Start Time	T_{SS}	$V_B=0.75V$	5	10	20	ms
Oscillator Block						
Oscillation Frequency	f_{OSC}	$V_{IN}=0.7V$	135	150	165	kHz
Oscillation Frequency (Low Frequency Control)	f_{OSC_LOW}	$V_{IN}=0.4V$	–	50	–	kHz
Oscillation Frequency deviation (Supply voltage)	f_{DV}	$V^+=6V$ to $40V$	–	1	–	%
Oscillation Frequency deviation (Temperature)	f_{DT}	$T_a=-40^\circ C$ to $+85^\circ C$	–	5	–	%
Error Amplifier Block						
Reference Voltage	V_B		-1.0%	0.8	+1.0%	V
Input Bias Current	I_B		-0.1	–	+0.1	μA
PWM Compare Block						
Maximum Duty Cycle	M_{AXDUTY}	$V_{IN}=0.7V$	85	90	–	%
Minimum ON Time	$T_{ON\ min}$		–	660	850	ns
Over Current Protection						
Cool Down Time	t_{COOL}		–	24	–	ms
Output Block						
Output ON Resistance	R_{ON}	$I_{SW}=8A$	–	55	80	$m\Omega$
Switching Current Limit	I_{LIM}		10.5	12.5	15	A
Switching Current Limit 2	I_{LIM2}	$V^+=30V$	10.5	12.5	15	A
Switching Leak Current	I_{LEAK}	$V^+=45V, V_{SW}=0V$	–	–	20	μA
General Characteristics						
Quiescent Current	I_{DD}	$R_L=no\ load, V_{IN}=0.7V$	–	7	9.5	mA

NJW4158

MARK SPECIFICATION

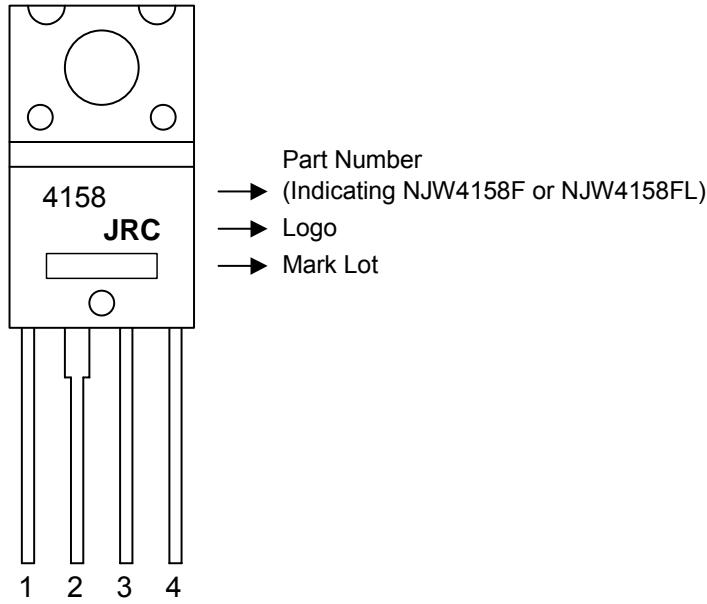

TYPICAL APPLICATIONS

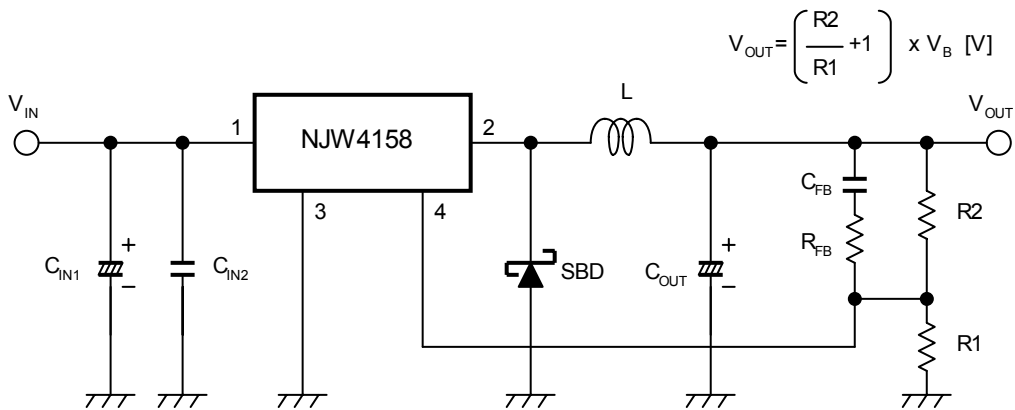

*When large current flows, V_{IN} line may be unstable. Therefore, you should put C_{IN} on near IC as much as possible.

■ TYPICAL CHARACTERISTICS

Oscillation Frequency vs. Supply Voltage
($V_{IN}=0.7V$, $T_a=25^\circ C$)

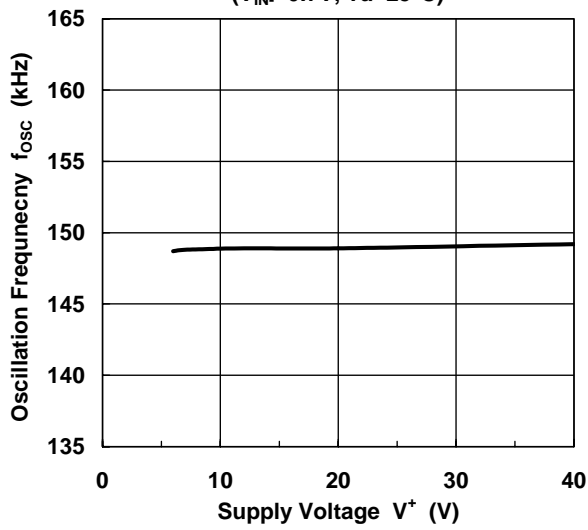

Reference Voltage vs. Supply Voltage
($T_a=25^\circ C$)

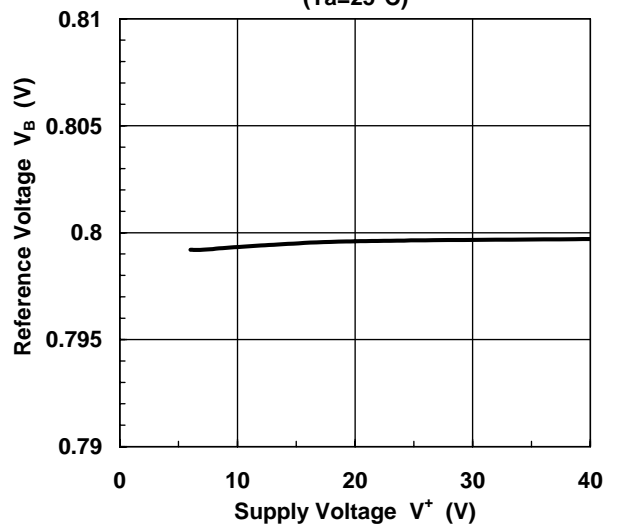

Quiescent Current vs. Supply Voltage
($R_L=no\ load$, $V_{IN}=0.7V$, $T_a=25^\circ C$)

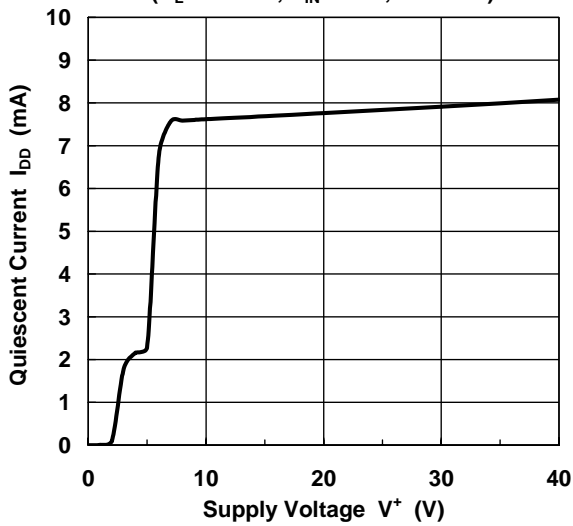

■ TYPICAL CHARACTERISTICS

Oscillation Frequency vs. Temperature
($V^+=12V$, $V_{IN}=0.7V$)

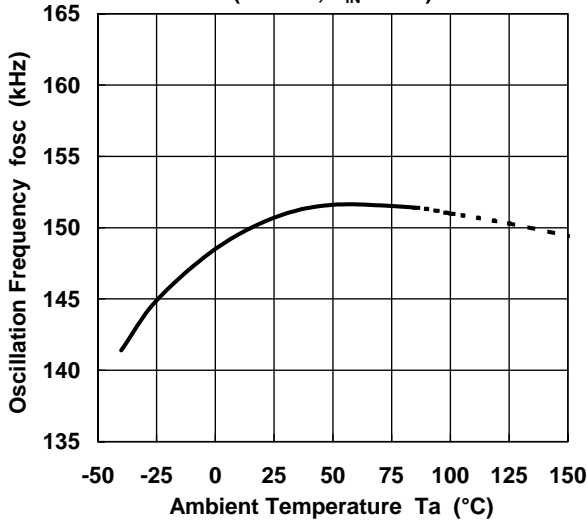

Reference Voltage vs. Temperature
($V^+=12V$)

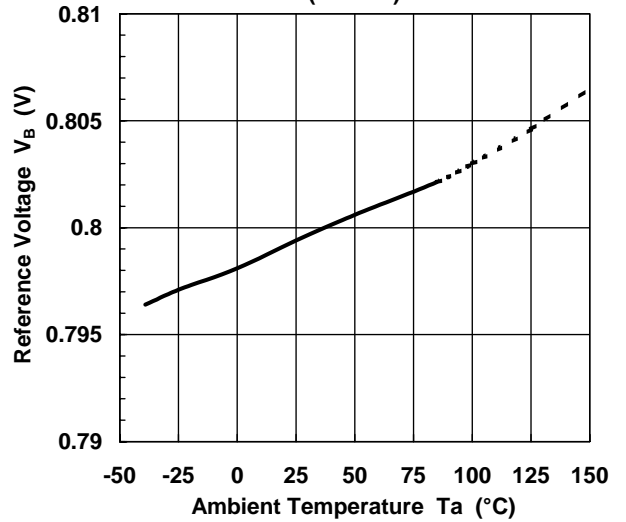

Switching Current Limit vs. Temperature
($V^+=12V$)

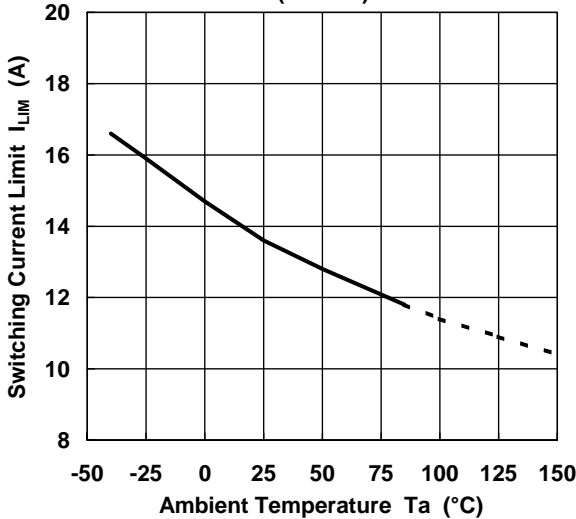

Switching Current Limit 2 vs. Temperature
($V^+=30V$)

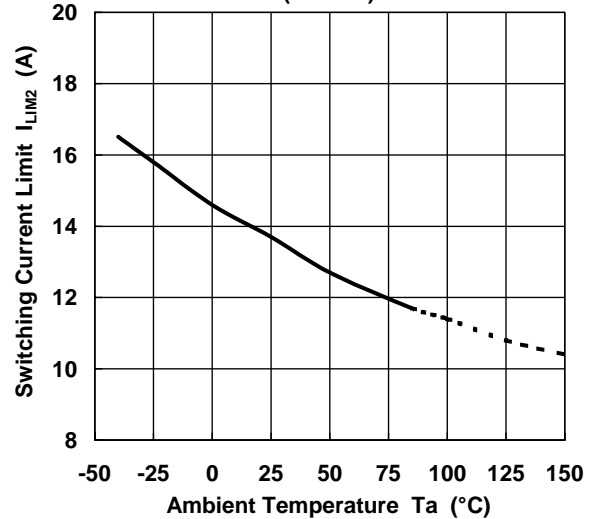

Output ON Resistance vs. Temperature
($I_{SW}=8A$)

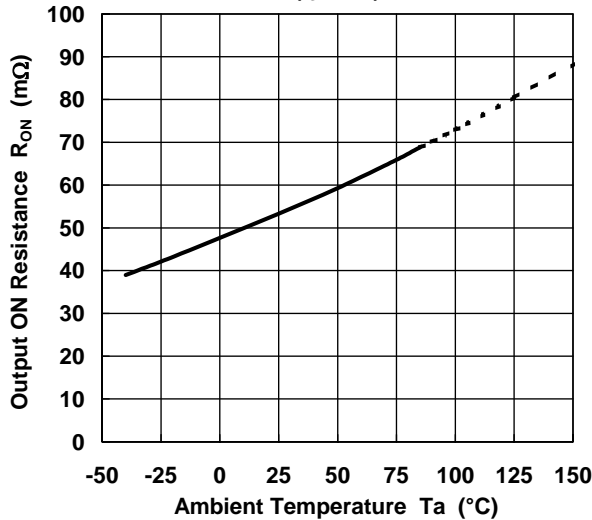

Switching Leak Current vs. Temperature
($V^+=45V$, $V_{SW}=0V$)

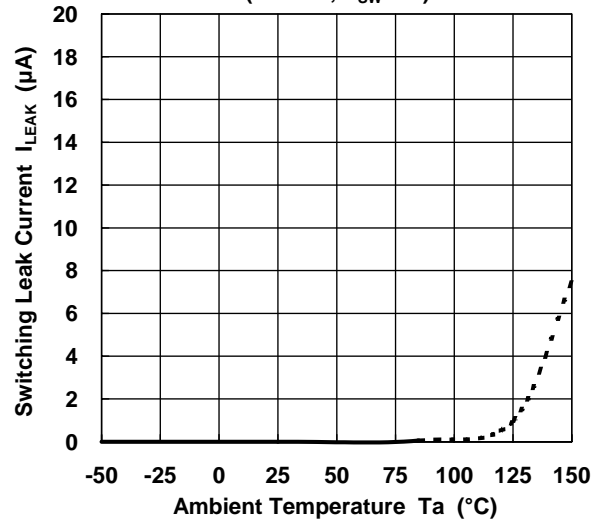

■ TYPICAL CHARACTERISTICS

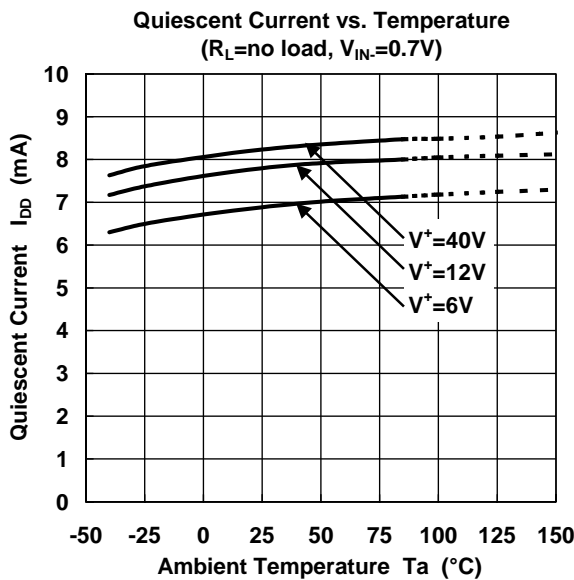
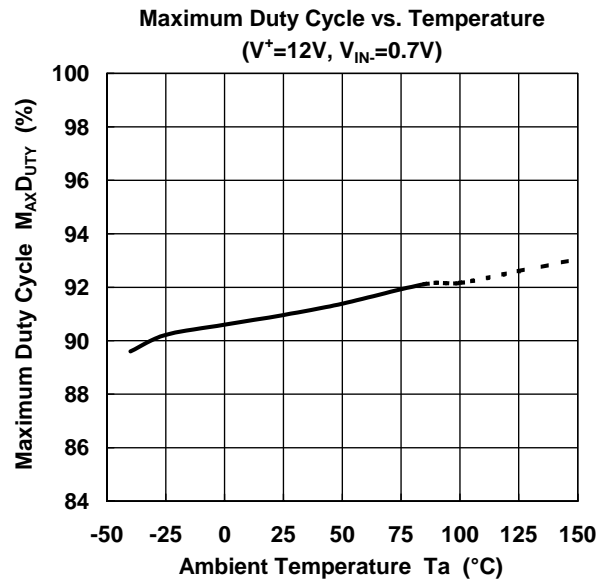
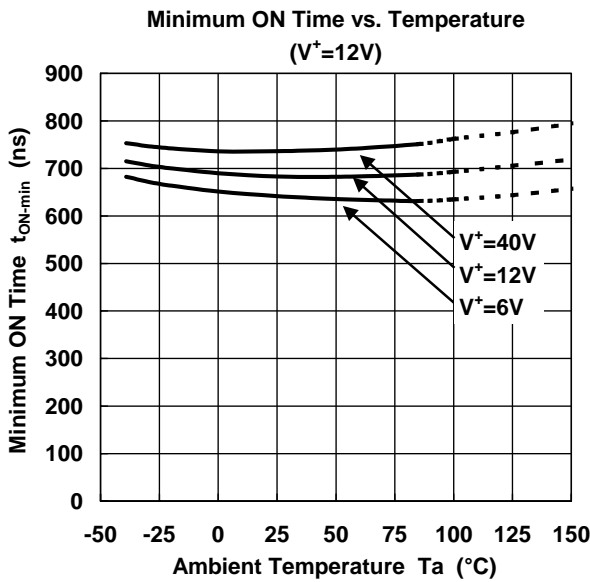
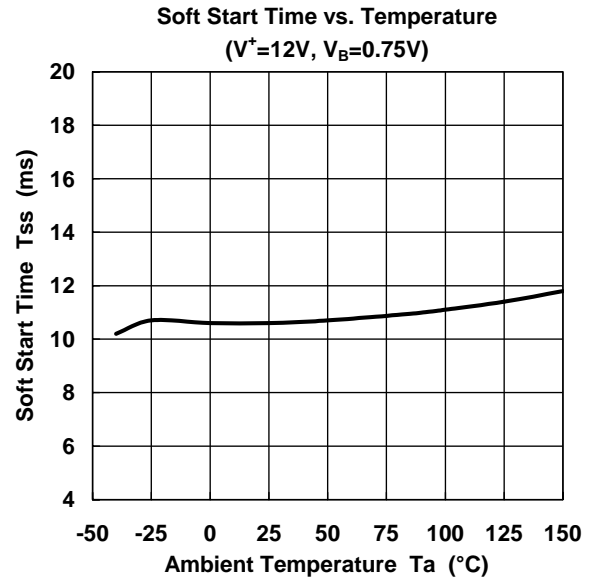
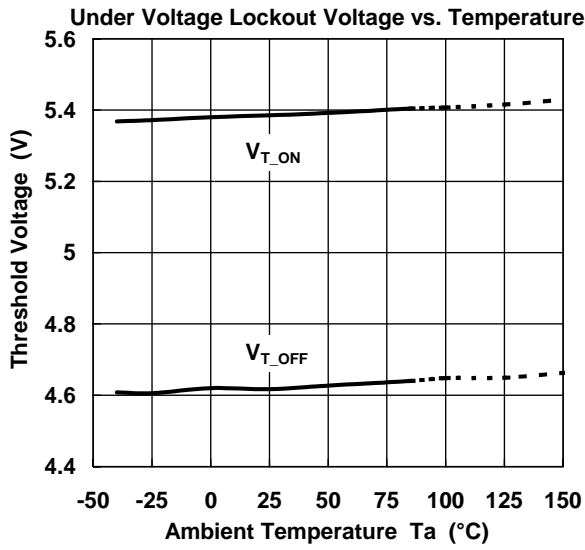

MEMO

[CAUTION]

The specifications on this databook are only given for information, without any guarantee as regards either mistakes or omissions. The application circuits in this databook are described only to show representative usages of the product and not intended for the guarantee or permission of any right including the industrial rights.

Mouser Electronics

Authorized Distributor

Click to View Pricing, Inventory, Delivery & Lifecycle Information:

[Nisshinbo Micro Devices:](#)

[NJW4158F](#)