

9V/ μ s High-Speed, Rail-to-rail I/O CMOS Operational Amplifier

FEATURES ($V^+=5V$, $V^-=0V$, $T_a=25^\circ C$)

•High Slew Rate	9V/ μ s
•Wide Bandwidth	5MHz
•Low Input Bias Current	1pA
•Rail-to-Rail Input and Output	
•Output Voltage	
$R_L=10k\Omega$	10mV from rail
$R_L=600\Omega$	70mV from rail
•Short Circuit Output Current	110mA
•Equivalent Input Noise Voltage	20nV/ \sqrt{Hz}
•Input Offset Voltage	5mV max.
•Low Input Offset Voltage Drift	2 μ V/ $^\circ C$ typ.
•Supply Voltage	2.7V to 5.5V
•Operating Temperature Range	-40 to 125 $^\circ C$
•RF-Noise Immunity	
•Unity-Gain Stable	
•Package	
NJU7046	SOT-23-5, SC-88A
NJU7047	SOP8 JEDEC 150 mil MSOP8(TVSP8)* DFN8-U1(ESON8-U1)
NJU7048	SOP14, SSOP14

*meet JEDEC MO-187-DA / thin type

APPLICATIONS

- High speed sensor Amplifiers
- Current sensor amplifiers
- Photodiode amplifiers
- ADC front ends
- Battery-powered instruments

DESCRIPTION

The NJU7046/NJU7047/NJU7048 are rail to rail input and output single supply operational amplifier featuring high speed and low input bias current.

9V/ μ s slew rate, 5MHz gain bandwidth, 1pA input bias current and -40 to 125 $^\circ C$ operating temperature range, make these amplifiers useful in wide variety of applications such as filters, integrators, current sensing, photodiode amplifiers and industrial applications.

The rail-to-rail input and output enables designers to buffers of input and output for ADC, DAC, ASIC and other wide output swing devices.

The NJU7046/NJU7047/NJU7048 operates in single supply 2.7V to 5.5V, and input common-mode voltage range includes the supply rails. Output voltage typically swings to within 70mV of the supply rails with 600 Ω load, and 110mA short-circuit current drive capability.

The NJU7046/NJU7047/NJU7048 are high RF-immunity to reduce malfunctions caused by RF noises from mobile phones and others.

The NJU7046 is available in 5-pin SC-88A and SOT-23 package. NJU7047 is available in 8-pin SOP: JEDEC 150 mil, MSOP(TVSP): meet JEDEC MO-187-DA / thin and DFN that is thin and 2mm square small package. NJU7048 is available in 14-pin SOP and SSOP package.

RELATED PRODUCTS

Features	Single	Dual	Quad
0.8V/ μ s, 2.1MHz, 260 μ A/ch Rail-to-rail Output	NJU7056	NJU7057	NJU7058
35V/ μ s, 34MHz, Rail-to-rail I/O (High slew rate type)	NJU77701		

PIN CONFIGURATION

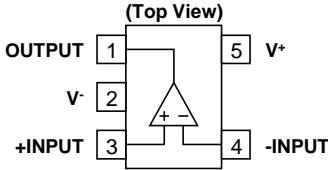
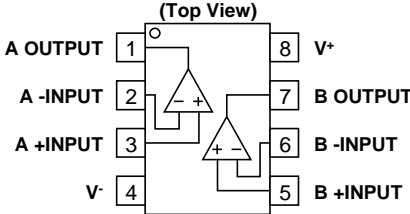
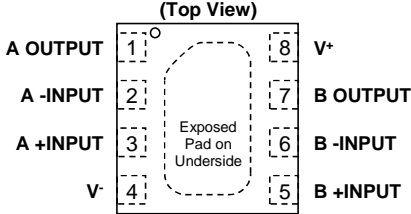
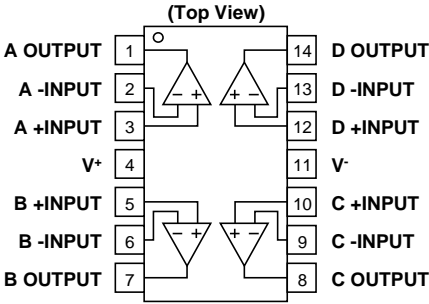
Pin Function			
Package	SC-88A	SOT-23-5	
Product Name	NJU7046F3	NJU7046F	
Pin Function			 <p>Connect to exposed pad to V⁻</p>
Package	SOP8 JEDEC 150 mil.	MSOP8(TVSP8)	DFN8-U1(ESON8-U1)
Product Name	NJU7047E	NJU7047RB1	NJU7047KU1
Pin Function			
Package	SOP14	SSOP14	
Product Name	NJU7048G	NJU7048V	

■ ABSOLUTE MAXIMUM RATINGS (Ta=25°C, unless otherwise noted.)

PARAMETER	SYMBOL	RATING	UNIT
Supply Voltage	V ⁺	7	V
Input Voltage ⁽¹⁾	V _{IN}	V ⁻ - 0.3 to V ⁺ + 0.3	V
Differential Input Voltage ⁽²⁾	V _{ID}	±7 ⁽³⁾	V
Input Current ⁽⁴⁾	I _{IN}	2	mA
Power Dissipation ⁽⁵⁾	P _D	(2-layer / 4-layer) ⁽⁶⁾	
SOT-23-5		480 / 640	mW
SC-88A		360 / 480	
SOP8 JEDEC 150 mil.		620 / 870	
MSOP8(TVSP8)		510 / 670	
DFN8-U1(ESON8-U1)		450 ⁽⁷⁾ / 1200 ⁽⁷⁾	
SOP14		1000 / 1500	
SSOP14	500 / 690		
Operating Temperature Range	T _{opr}	-40 to +125	°C
Storage Temperature Range	T _{stg}	-55 to +150	°C

(1) The absolute maximum input voltage is limited at 7V.

(2) Differential voltage is the voltage difference between +INPUT and -INPUT.

(3) For supply voltage less than 7V, the absolute maximum rating is equal to the supply voltage.

(4) Input voltages outside the supply voltage will be clamped by ESD protection diodes. If the input voltage exceeds the supply voltage, the input current must be limited 2 mA or less by using a restriction resistance.

(5) Power dissipation is the power that can be consumed by the IC at Ta=25°C, and is the typical measured value based on JEDEC condition. When using the IC over Ta=25°C subtract the value [mW/°C]=P_D/(T_{stg}(MAX)-25) per temperature.

(6) 2-layer: EIA/JEDEC STANDARD Test board (76.2x114.3x1.6mm, 2layers, FR-4) mounting

4-layer: EIA/JEDEC STANDARD Test board (76.2x114.3x1.6mm, 4layers, FR-4) mounting

(7) 2-layer: Mounted on glass epoxy board. (101.5x114.5x1.6mm: based on EIA/JEDEC standard, 2Layers FR-4, with Exposed Pad)

4-layer: Mounted on glass epoxy board. (101.5x114.5x1.6mm: based on EIA/JEDEC standard, 4Layers FR-4, with Exposed Pad)

*For 4Layers: Applying 99.5x99.5mm inner Cu area and a thermal via hole to a board based on JEDEC standard JESD51-5)

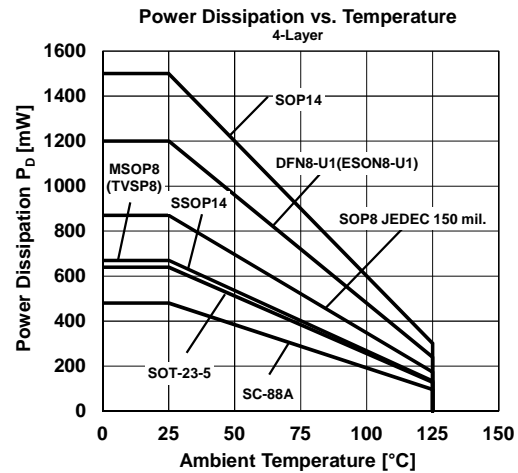
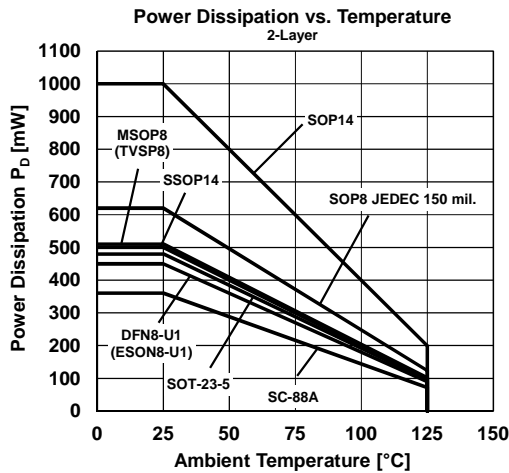

■ RECOMMENDED OPERATING CONDITION (Ta=25°C)

PARAMETER	CONDITION	MIN.	TYP.	MAX.	UNIT
Supply Voltage		2.7	-	5.5	V

■ ELECTRICAL CHARACTERISTICS ($V^+=5V$, $V^-=0V$, $T_a=25^\circ C$, unless otherwise noted.)

PARAMETER	SYMBOL	TEST CONDITION	MIN.	TYP.	MAX.	UNIT
DC CHARACTERISTICS						
Supply Current(All Amplifiers)	I_{SUPPLY}	No Signal	-	1.4	2.2	mA
NJU7046						
NJU7047						
NJU7048						
Input Offset Voltage	V_{IO}	$V_{ICM}=0V, 2.5V, 5V$	-	0.9	5	mV
Input Offset Voltage Drift	$\Delta V_{IO}/\Delta T$		-	2	-	$\mu V/^\circ C$
Input Bias Current	I_B		-	1	-	pA
Input Offset Current	I_{IO}		-	1	-	pA
Open-Loop Voltage Gain	A_V	$V_{out}=1.5$ to $3.5V$, $R_L=10k\Omega$ to $2.5V$	90	110	-	dB
Common-Mode Rejection Ratio	CMR	$V_{ICM}=0V$ to $5V$	60	80	-	dB
Supply Voltage Rejection Ratio	SVR	$V^+=2.7V$ to $5.5V$, $V_{ICM}=0V$	65	90	-	dB
Common-Mode Input Voltage Range	V_{ICM}	CMR ≥ 60 dB	0	-	5	V
High-level Output Voltage	V_{OH}	$R_L=10k\Omega$ to $2.5V$	4.95	4.99	-	V
		$R_L=600\Omega$ to $2.5V$	4.88	4.93	-	V
Low-level Output Voltage	V_{OL}	$R_L=10k\Omega$ to $2.5V$	-	0.01	0.05	V
		$R_L=600\Omega$ to $2.5V$	-	0.07	0.12	V
AC CHARACTERISTICS						
Slew Rate	SR	$G_V=0$ dB, $R_L=10k\Omega$, $C_L=20$ pF, $V_{IN}=2V_{PP}$	5	9	-	V/ μs
Gain Bandwidth Product	GBW	$G_V=40$ dB, $R_F=100k\Omega$, $R_L=10k\Omega$, $C_L=20$ pF	-	5	-	MHz
Phase Margin	Φ_M	$G_V=40$ dB, $R_F=100k\Omega$, $R_L=10k\Omega$, $C_L=20$ pF	-	70	-	deg
Gain Margin	G_M	$G_V=40$ dB, $R_F=100k\Omega$, $R_L=10k\Omega$, $C_L=20$ pF	-	16	-	dB
Equivalent Input Noise Voltage	V_{NI}	$f=1$ kHz	-	20	-	nV/ \sqrt{Hz}
Total Harmonic Distortion + Noise	THD+N	$G_V=0$ dB, $R_L=10k\Omega$, $f=1$ kHz, $V_{out}=1V_{PP}$	-	0.01	-	%
Channel Separation	CS	$f=1$ kHz, NJU7047/NJU7048	-	130	-	dB

■ ELECTRICAL CHARACTERISTICS ($V^+=2.7V$, $V^-=0V$, $T_a=25^\circ C$, unless otherwise noted.)

PARAMETER	SYMBOL	TEST CONDITION	MIN.	TYP.	MAX.	UNIT
DC CHARACTERISTICS						
Supply Current(All Amplifiers)	I_{SUPPLY}	No Signal	-	1.2	2	mA
NJU7046			-	2.5	4	mA
NJU7047			-	4.5	7.2	mA
NJU7048						
Input Offset Voltage	V_{IO}	$V_{ICM}=0V, 1.35V, 2.7V$	-	0.9	5	mV
Input Offset Voltage Drift	$\Delta V_{IO}/\Delta T$		-	2	-	$\mu V/^\circ C$
Input Bias Current	I_B		-	1	-	pA
Input Offset Current	I_{IO}		-	1	-	pA
Open-Loop Voltage Gain	A_V	$V_{out}=0.35$ to $2.35V$, $R_L=10k\Omega$ to $1.35V$	90	110	-	dB
Common-Mode Rejection Ratio	CMR	$V_{ICM}=0V$ to $2.7V$	55	75	-	dB
Supply Voltage Rejection Ratio	SVR	$V^+=2.7V$ to $5.5V$, $V_{ICM}=0V$	65	90	-	dB
Common-Mode Input Voltage Range	V_{ICM}	CMR \geq 55dB	0	-	2.7	V
High-level Output Voltage	V_{OH}	$R_L=10k\Omega$ to $1.35V$	2.65	2.69	-	V
		$R_L=600\Omega$ to $1.35V$	2.6	2.64	-	V
Low-level Output Voltage	V_{OL}	$R_L=10k\Omega$ to $1.35V$	-	0.01	0.05	V
		$R_L=600\Omega$ to $1.35V$	-	0.05	0.1	V
AC CHARACTERISTICS						
Slew Rate	SR	$G_V=0dB$, $R_L=10k\Omega$, $C_L=20pF$, $V_{IN}=2V_{PP}$	3.5	7	-	V/ μs
Gain Bandwidth Product	GBW	$G_V=40dB$, $R_F=100k\Omega$, $R_L=10k\Omega$, $C_L=20pF$	-	5	-	MHz
Phase Margin	Φ_M	$G_V=40dB$, $R_F=100k\Omega$, $R_L=10k\Omega$, $C_L=20pF$	-	65	-	deg
Gain Margin	G_M	$G_V=40dB$, $R_F=100k\Omega$, $R_L=10k\Omega$, $C_L=20pF$	-	18	-	dB
Equivalent Input Noise Voltage	V_{NI}	$f=1kHz$	-	20	-	nV/ \sqrt{Hz}
Total Harmonic Distortion + Noise	THD+N	$G_V=0dB$, $R_L=10k\Omega$, $f=1kHz$, $V_{out}=1V_{PP}$	-	0.02	-	%
Channel Separation	CS	$f=1kHz$, NJU7047/NJU7048	-	130	-	dB

■ TYPICAL CHARACTERISTICS

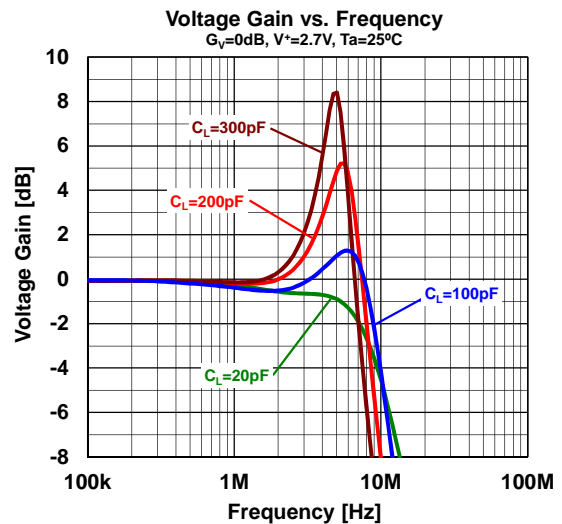
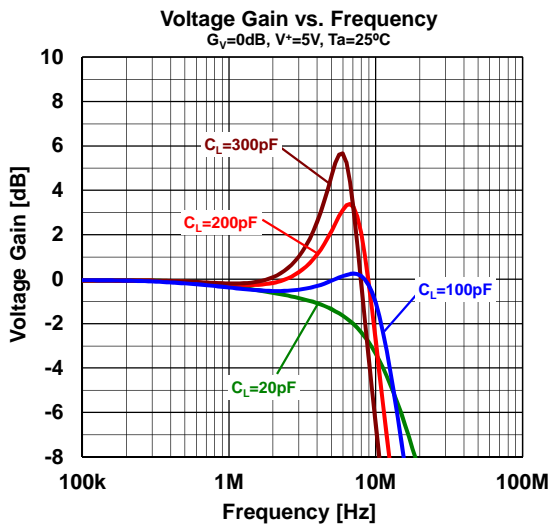
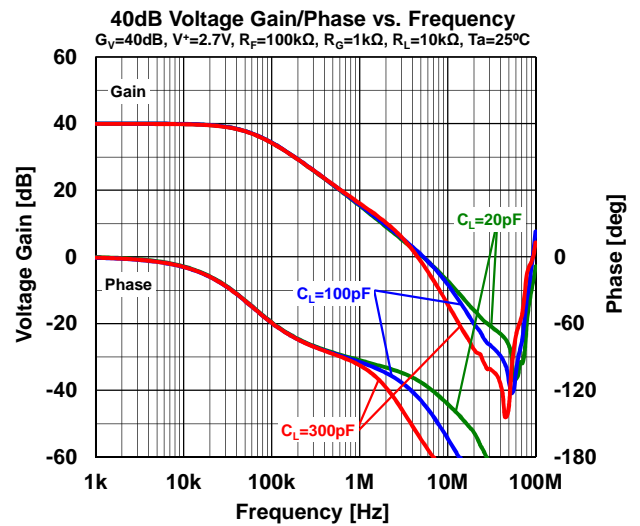
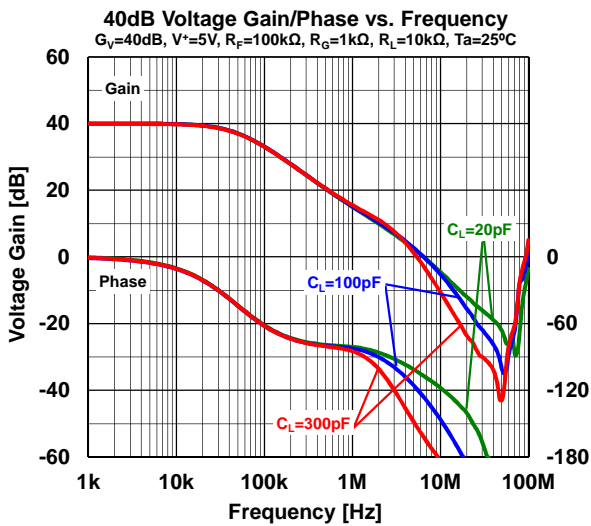
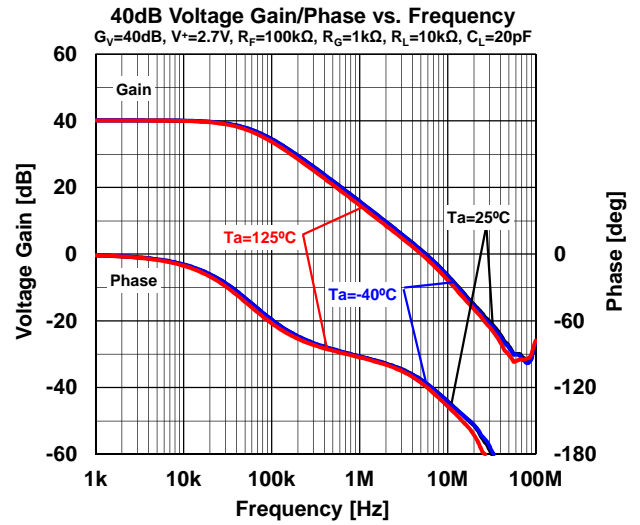
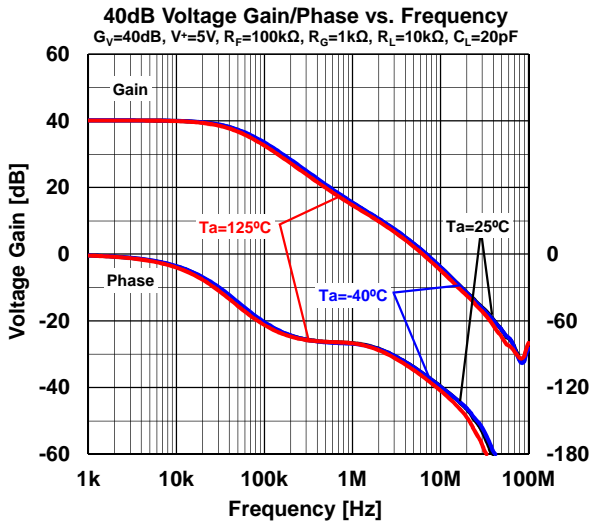

TYPICAL CHARACTERISTICS

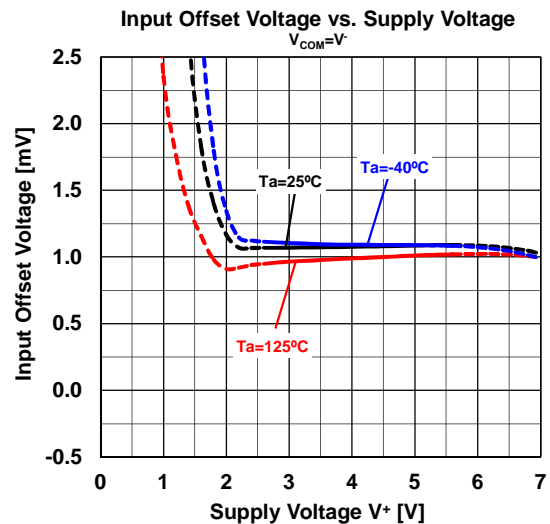
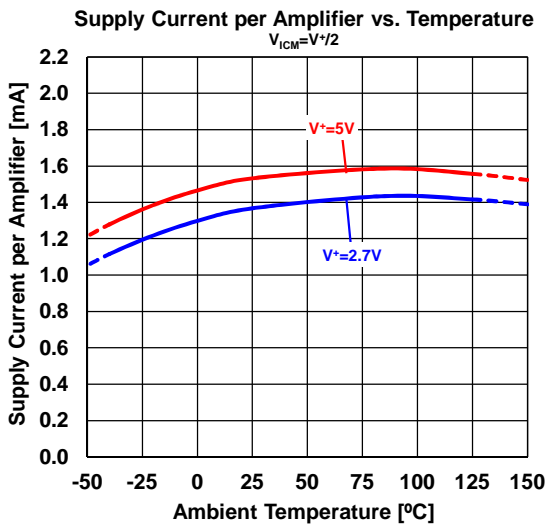
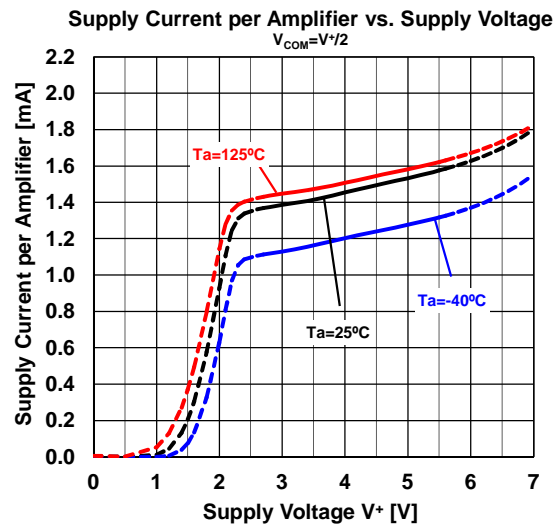
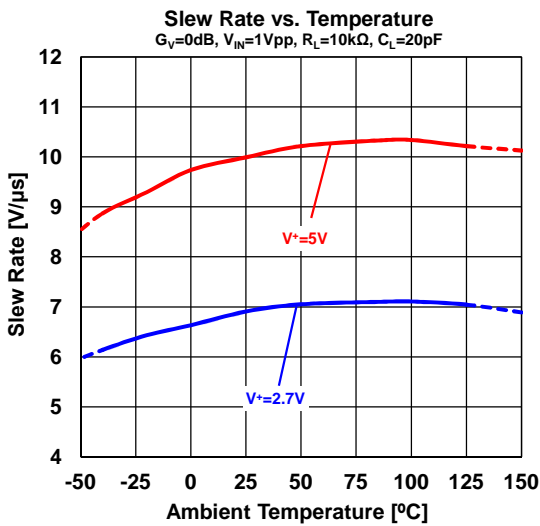
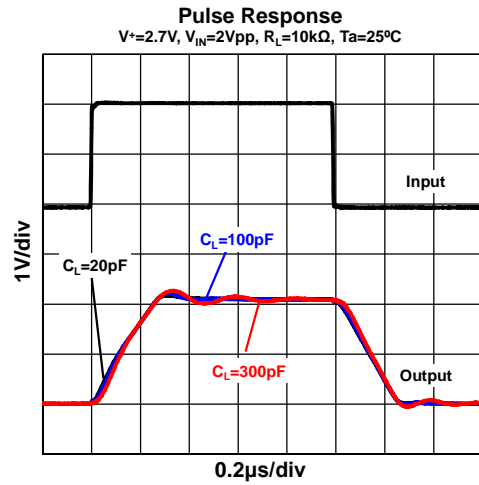
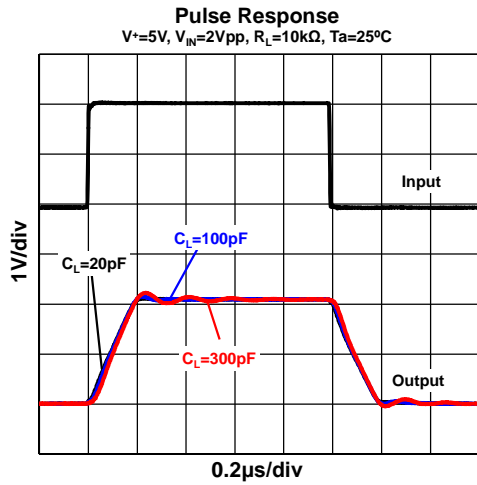

■ TYPICAL CHARACTERISTICS

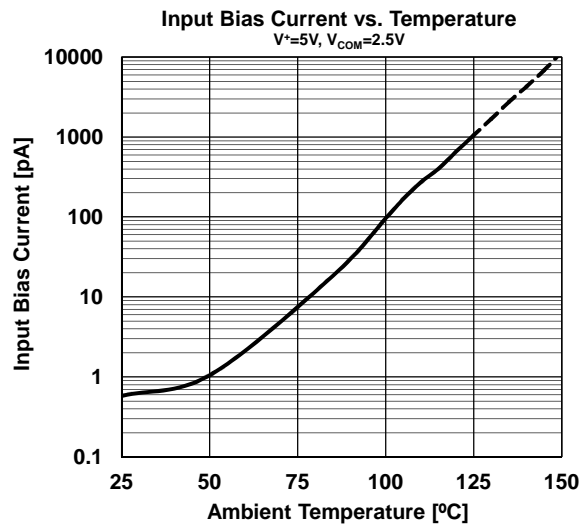
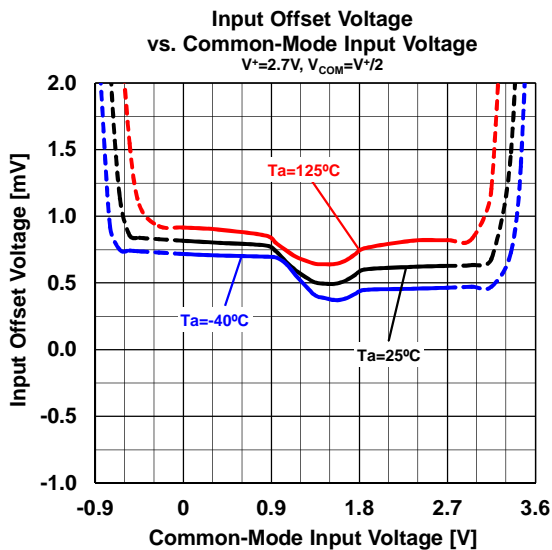
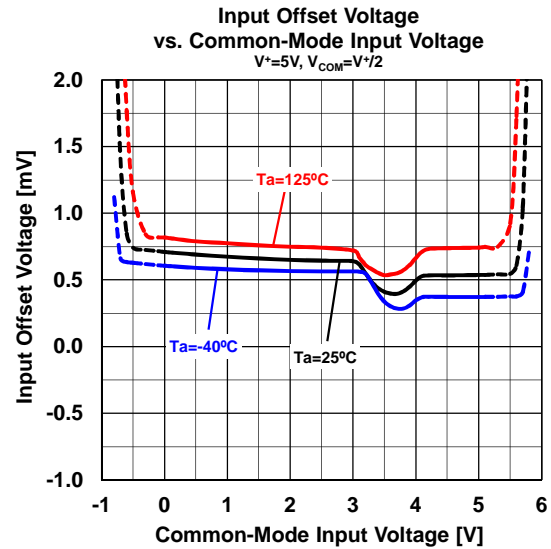
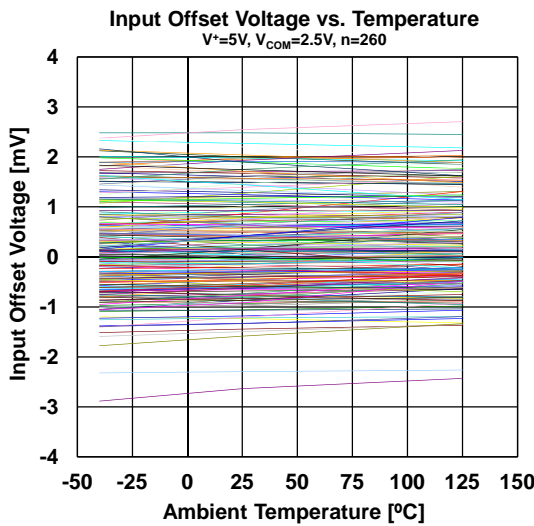
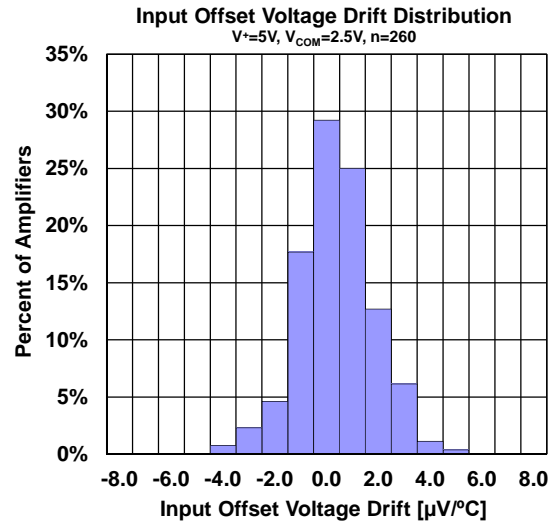
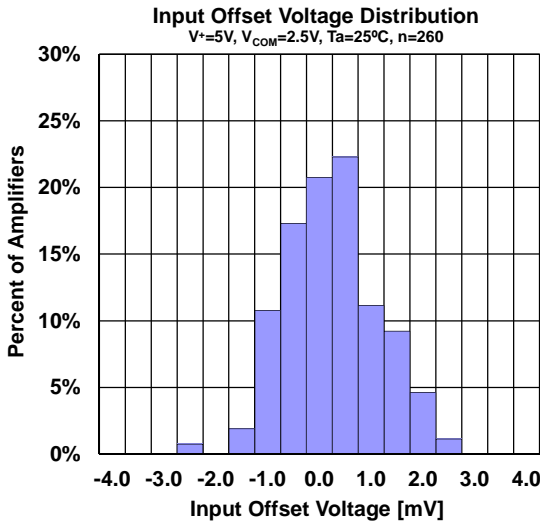

■ TYPICAL CHARACTERISTICS

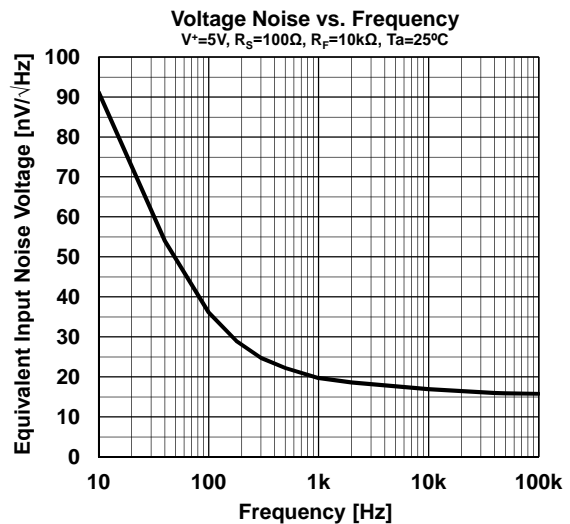
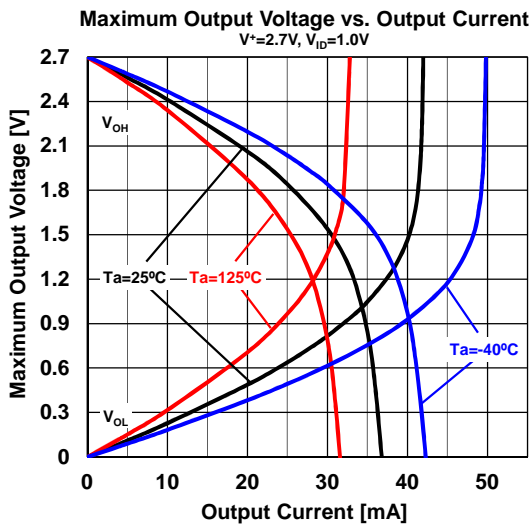
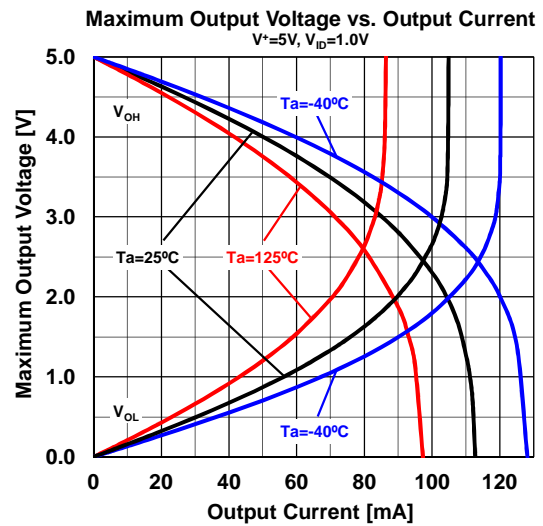
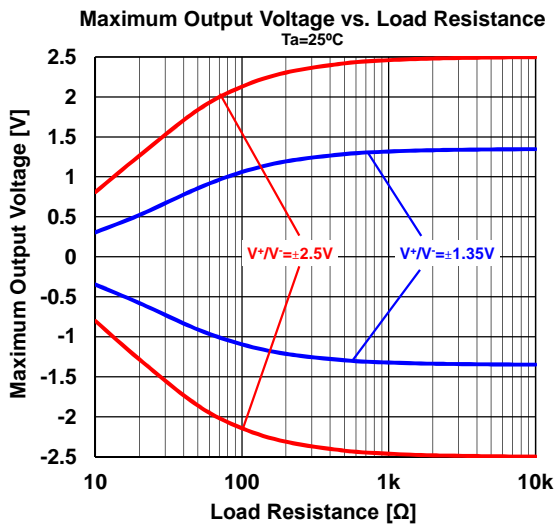
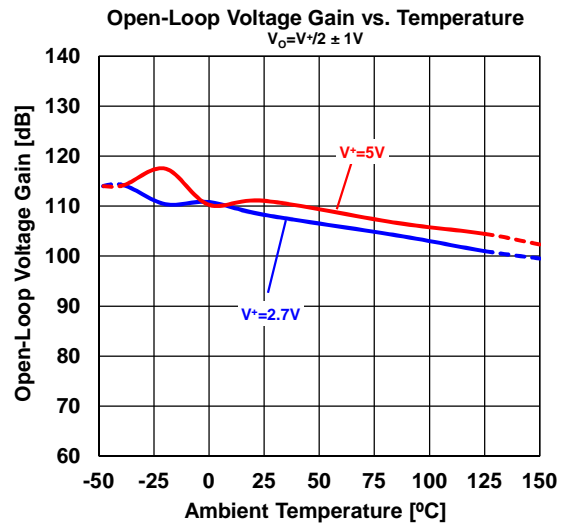
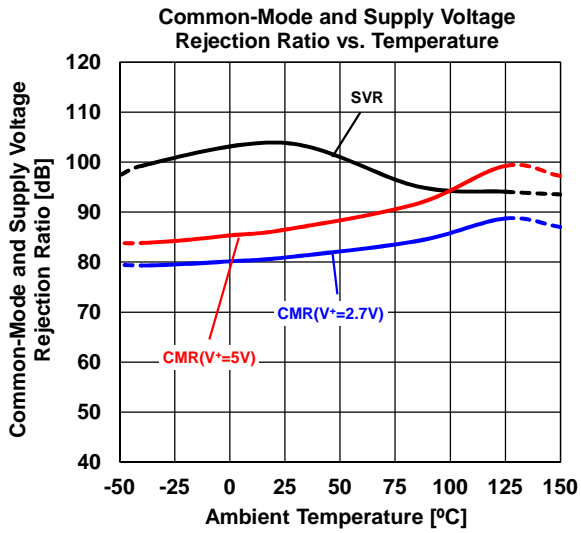

■ TYPICAL CHARACTERISTICS

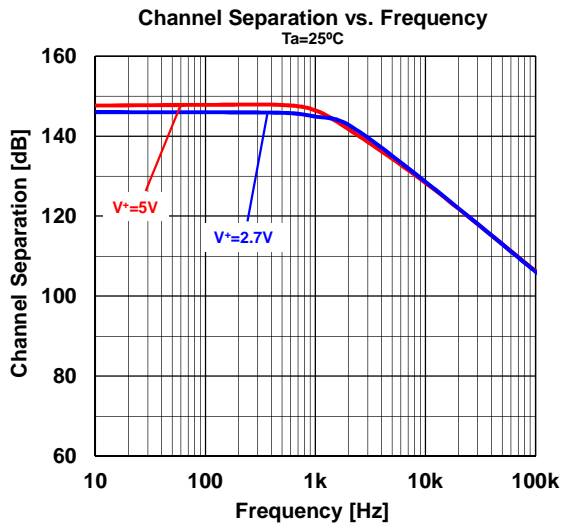

APPLICATION NOTE

Single and Dual Supply Voltage Operation

The NJU7046/NJU7047/NJU7048 works with both single supply and dual supply when the voltage supplied is between V^+ and V^- . These amplifiers operate from single +2.7 to +5.5V supply and dual $\pm 1.35V$ to $\pm 2.75V$ supply.

Common-Mode Input Voltage Range

When the supply voltage does not meet the condition of electrical characteristics, the range of common-mode input voltage is as follows:

$$V_{ICM} (\text{typ.}) = V^- \text{ to } V^+ \quad (T_a = 25^\circ\text{C})$$

Difference of V_{ICM} when Temperature change, refer to typical characteristic graph.

During designing, consider variations in characteristics for use with allowance.

Maximum Output Voltage Range

When the supply voltage does not meet the condition of electrical characteristics, the range of the typ. value of the maximum output voltage is as follows:

$$V_{OM} (\text{typ.}) = V^+ - 10\text{mV} \text{ to } V^- + 10\text{mV} \quad (R_L = 10\text{k}\Omega \text{ to } V^+/2, T_a = 25^\circ\text{C})$$

During designing, consider variations in characteristics and temperature characteristics for use with allowance.

In addition, also note that the output voltage range becomes narrow as shown in typical characteristics graph when an output current increases.

Input Voltage Exceeding the Supply Voltage

Inputs of the NJU7046/NJU7047/NJU7048 are protected by ESD diodes (shown in Figure1) that will conduct if the input voltages exceed the power supplies by more than approximately 300mV.

Momentary voltages greater than 300mV beyond the power supply, inputs can be tolerated if the current is limited to 2mA. Figure2 is easily accomplished with an input resistor. If the input voltage exceeds the supply voltage, the input current must be limited 2mA or less by using a restriction resistance (R_{LIMIT}) as shown in figure2.

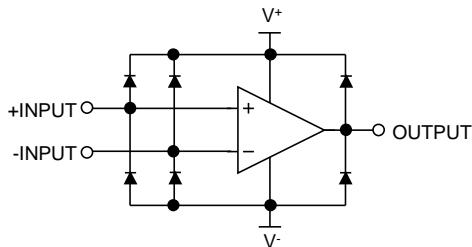

Figure1. Simplified Schematic

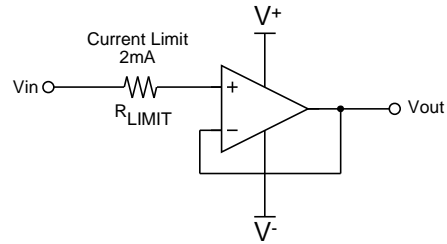

Figure2. Input Current Protection for Voltages exceeding the Supply Voltage.

Capacitive load

The NJU7046/NJU7047/NJU7048 can use at unity gain follower, but the unity gain follower is the most sensitive configuration to capacitive loading. The combination of capacitive load placed directly on the output of an amplifier along with the output impedance of the amplifier creates a phase lag which in turn reduces the phase margin of the amplifier. If phase margin is significantly reduced, the response will cause overshoot and ringing in the step response.

To drive heavy capacitive loads, an isolation resistor, R_{ISO} as shown Figure3, should be used. R_{ISO} improves the feedback loop's phase margin by making the output load resistive at higher frequencies. The larger the value of R_{ISO} , the more stable the output voltage will be. However, larger values of R_{ISO} result in reduced output swing, reduced output current drive and reduced frequency bandwidth.

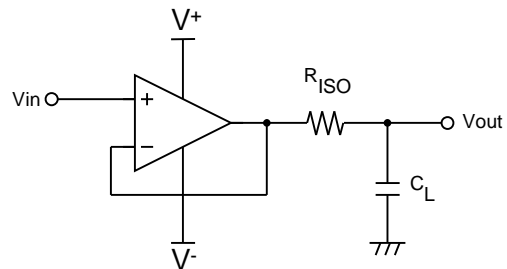
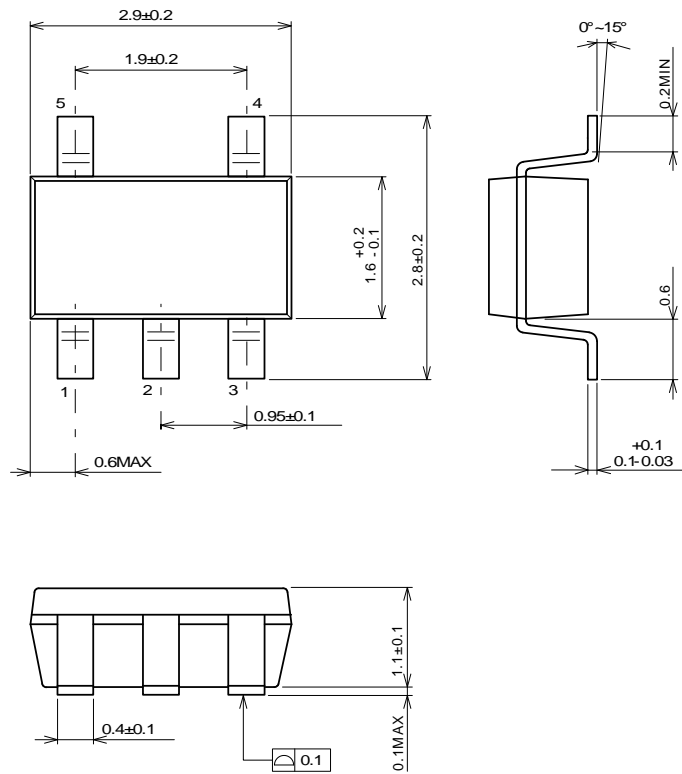

Figure3. Isolating capacitive load

■ PACKAGE DIMENSIONS



Unit: mm

SOT-23-5 Package

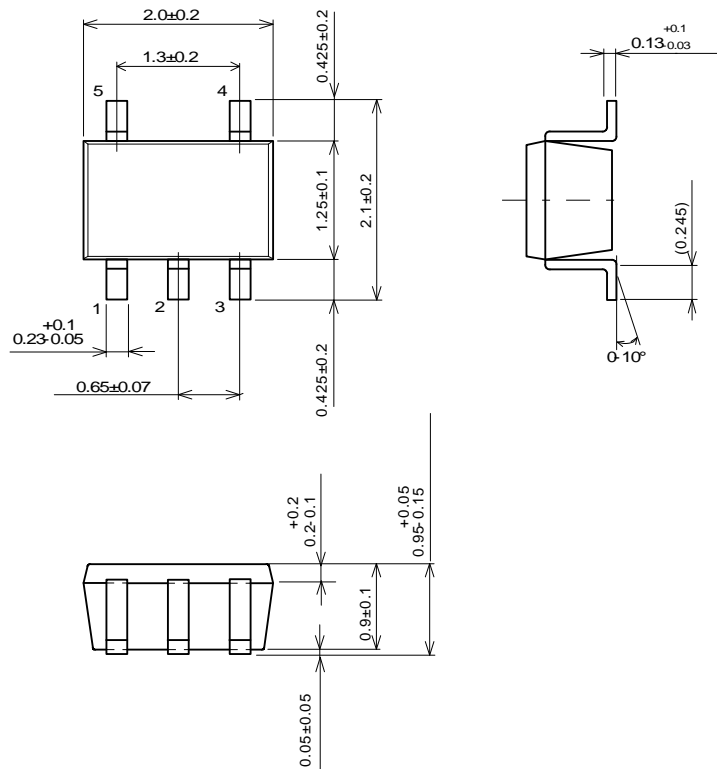

Unit: mm

SC-88A Package

■ PACKAGE DIMENSIONS

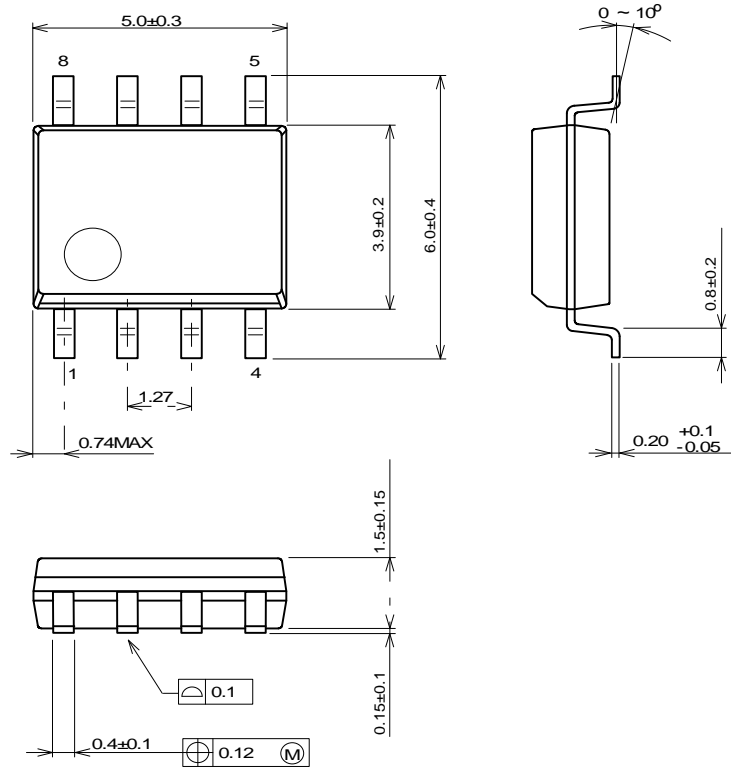

Unit: mm

SOP8 JEDEC 150 mil Package

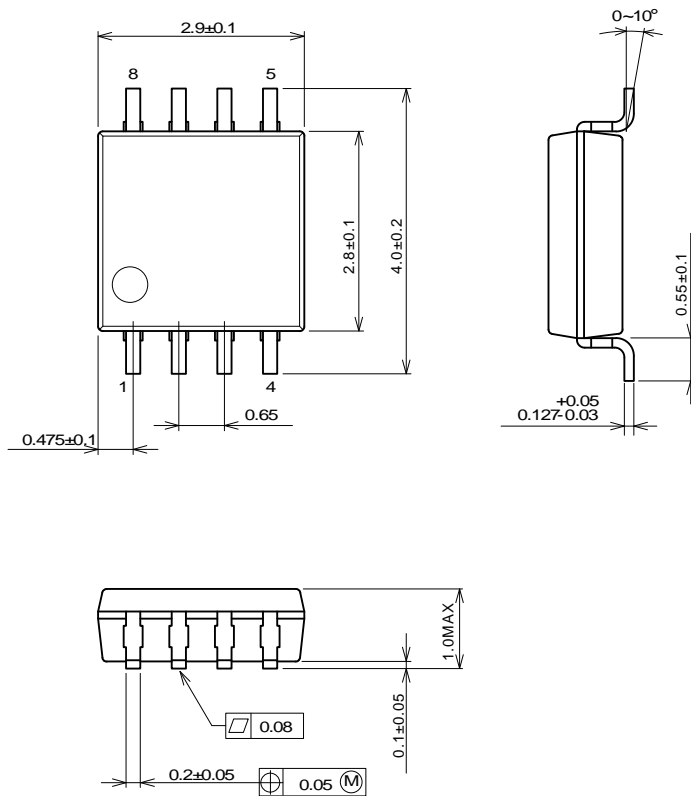

Unit: mm

MSOP8 (TVSP8) meet JEDEC MO-187-DA / thin Package

■ PACKAGE DIMENSIONS

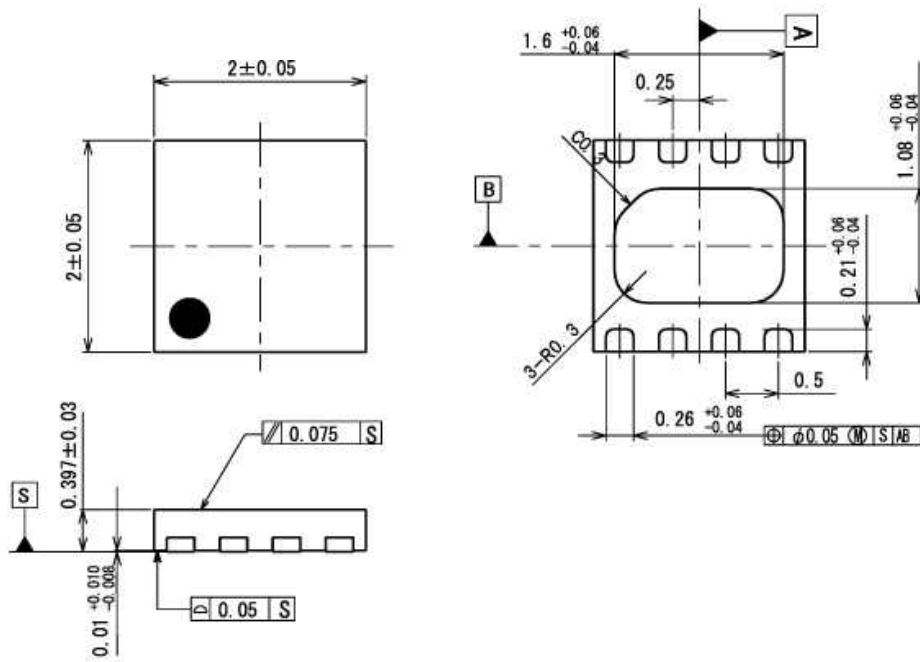

Unit: mm

DFN8-U1(ESON8-U1) Package

■ PACKAGE DIMENSIONS

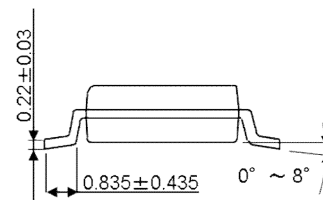
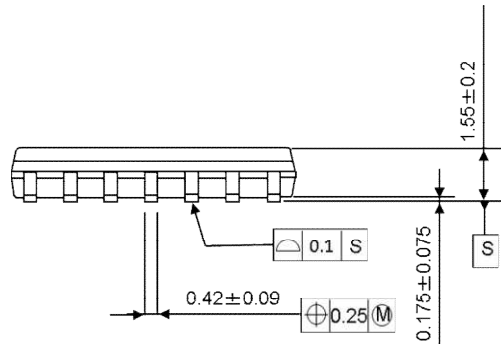
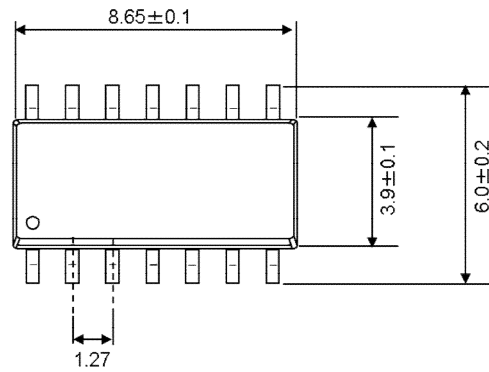

Unit: mm

SOP14 Package

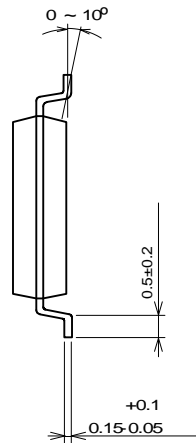
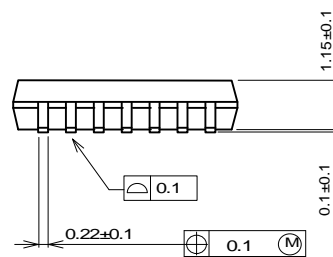
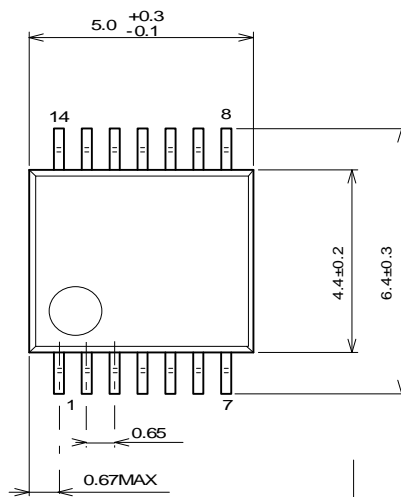

Unit: mm

SSOP14 Package

[CAUTION]
The specifications on this databook are only given for information, without any guarantee as regards either mistakes or omissions. The application circuits in this databook are described only to show representative usages of the product and not intended for the guarantee or permission of any right including the industrial rights.

Mouser Electronics

Authorized Distributor

Click to View Pricing, Inventory, Delivery & Lifecycle Information:

[Nisshinbo Micro Devices:](#)

[NJU7047E-TE1](#)