

NJM2068

■ ABSOLUTE MAXIMUM RATINGS(Ta=25°C)

PARAMETER	SYMBOL	RATING	UNIT
Supply Voltage	V ⁺ /V	±18	V
Differential Input Voltage Range	V _{ID}	±30	V
Common Mode Input Voltage Range	V _{IC}	±15 (Note1)	V
Power Dissipation	P _D	DIP8: 500 DMP8: 300 SSOP8: 250 SIP8: 800	mW
Operating Temperature Range	T _{opr}	-20~+75	°C
Storage Temperature Range	T _{stg}	-40~+125	°C

(Note1) For supply voltage less than ±15V, the absolute maximum input voltage is equal to supply voltage.

■ RECOMMENDED OPERATING VOLTAGE(Ta=25°C)

PARAMETER	SYMBOL	TEST CONDITION	MIN.	TYP.	MAX.	UNIT
Supply Voltage	V ⁺ /V		±4	-	±18	V

■ ELECTRICAL CHARACTERISTICS(V⁺/V=±15V, Ta=25°C, unless otherwise noted.)

PARAMETER	SYMBOL	TEST CONDITION	MIN.	TYP.	MAX.	UNIT
Input Offset Voltage	V _{IO}	R _S ≤10kΩ	-	0.3	3	mV
Input Offset Current	I _{IO}		-	5	200	nA
Input Bias Current	I _B		-	150	1000	nA
Input Resistance	R _{IN}		50	300	-	kΩ
Voltage Gain	A _V	R _L ≥2kΩ, V _O =±10V	90	120	-	dB
Maximum Output Voltage	V _{OM}	R _L ≥2kΩ	±12	±13.5	-	V
Common Mode Input Voltage	V _{ICM}		±12	±13.5	-	V
Common Mode Rejection Ratio	CMR	R _S ≤10kΩ	80	110	-	dB
Supply Voltage Rejection Ratio	SVR	R _S ≤10kΩ	80	120	-	dB
Slew Rate	SR	R _L ≥2kΩ	-	6	-	V/μs
Gain Bandwidth Product1	G _{B1}	f=10kHz	-	27	-	MHz
Gain Bandwidth Product2	G _{B2}	f=100kHz	-	19	-	MHz
Unity Gain Frequency	f _T	A _V =1	-	5.5	-	MHz
Total Harmonic Distortion	THD	A _V =20dB, V _O =5V, R _L =2kΩ, f=1kHz	-	0.001	-	%
Equivalent Input Noise Voltage	V _{NI}	FLAT+JIS A, R _S =300Ω	-	0.44	0.56	μV
Supply Current	I _{CC}		-	5	8	mA

■ ELECTRICAL CHARACTERISTICS (D-Rank type(Note2), V⁺/V=±15V, Ta=25°C, unless otherwise noted.)

PARAMETER	SYMBOL	TEST CONDITION	MIN.	TYP.	MAX.	UNIT
Equivalent Input Noise Voltage	V _{NI}	RIAA, R _S =2.2kΩ	-	-	1.4	μV

(Note2)D-rank type is a Equivalent Input Noise Voltage selected product. It s only DIP, DMP and SIP package.

■ NOTICE

Oscillation might be caused when capacitor type load were connected. It is recommendable to insert series resistor (about 50Ω) at the output for preventing oscillation.

■ TYPICAL CHARACTERISTICS

40dB Gain/Phase vs. Frequency
 $V^+ / V^- = \pm 15V, R_L = 2k\Omega, C_L = 100pF, T_a = 25^\circ C$

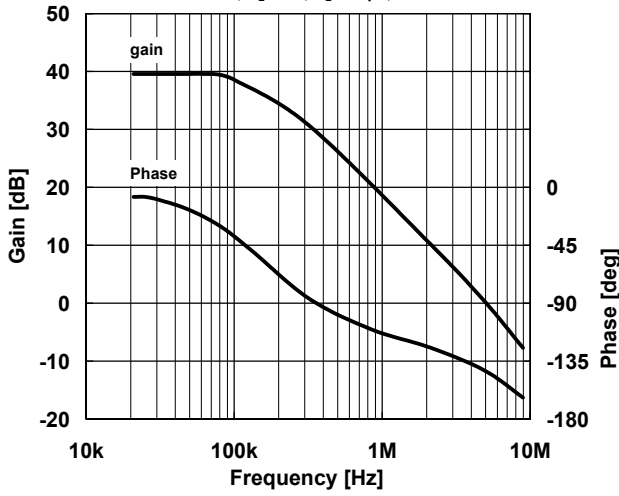

Maximum Output Voltage vs. Frequency
 $V^+ / V^- = \pm 15V, R_L = 2k\Omega, T_a = 25^\circ C$

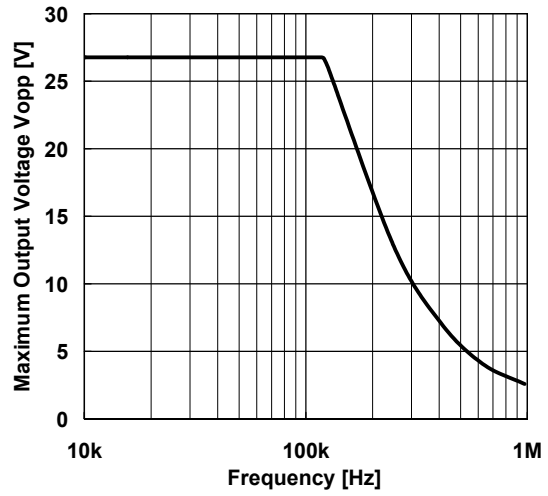

Maximum Output Voltage vs. Output Current
 $V^+ / V^- = \pm 15V, T_a = 25^\circ C$

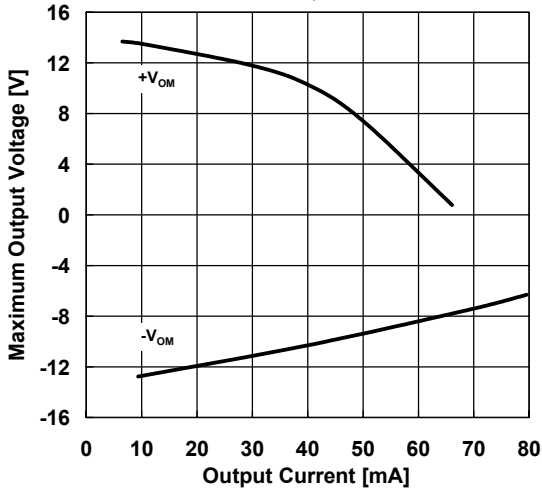

Maximum Output Voltage vs. Load Resistance
 $V^+ / V^- = \pm 15V, T_a = 25^\circ C$

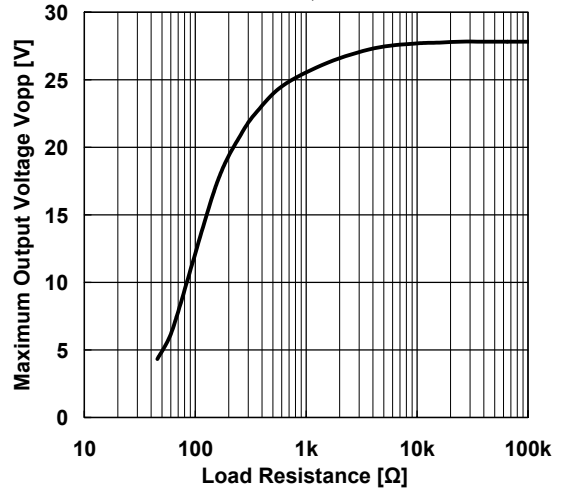

Voltage Noises. Source Resistance
 $V^+ / V^- = \pm 15V, JIS A, T_a = 25^\circ C$

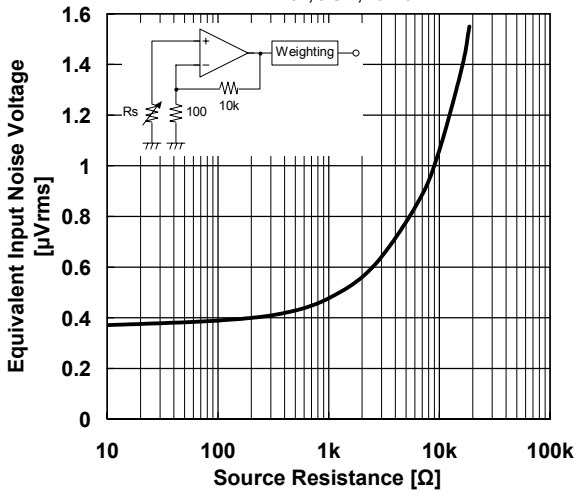

Supply Current vs. Supply Voltage
 No Signal, $R_L = \infty, T_a = 25^\circ C$

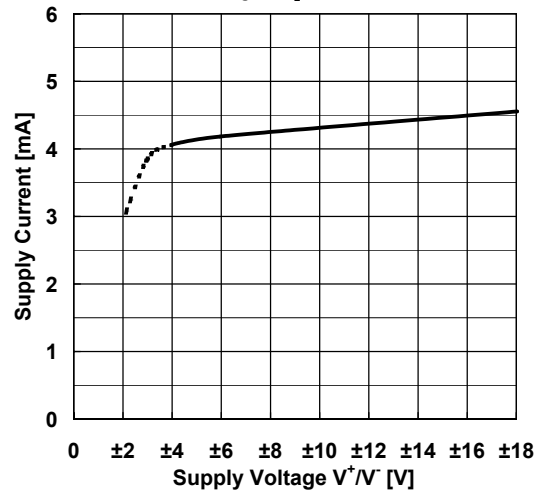

■ TYPICAL CHARACTERISTICS

Supply Current vs. Temperature
 $V^+/V^-=\pm 15V$

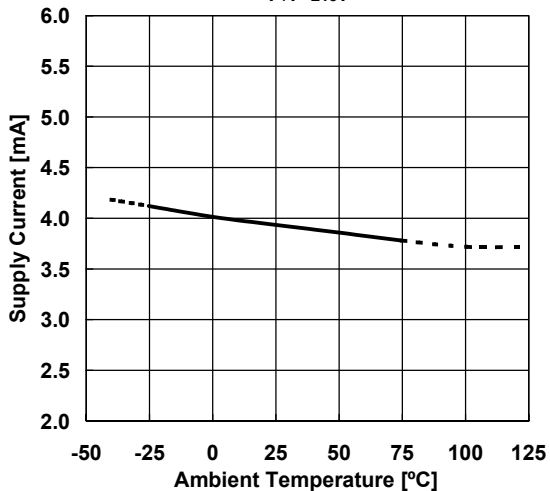

Input Offset Voltage vs. Temperature
 $V^+/V^-=\pm 15V$

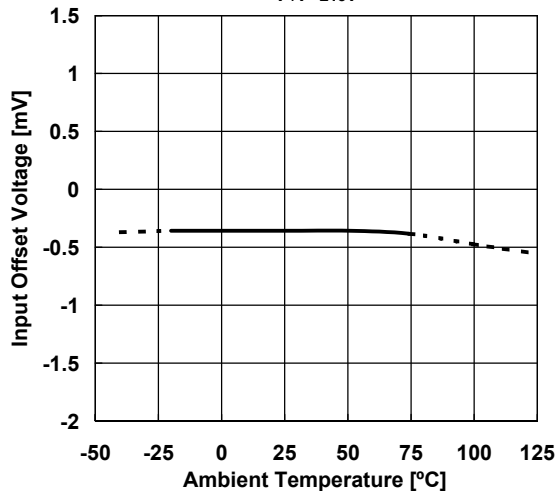

Input Bias Current vs. Temperature
 $V^+/V^-=\pm 15V$

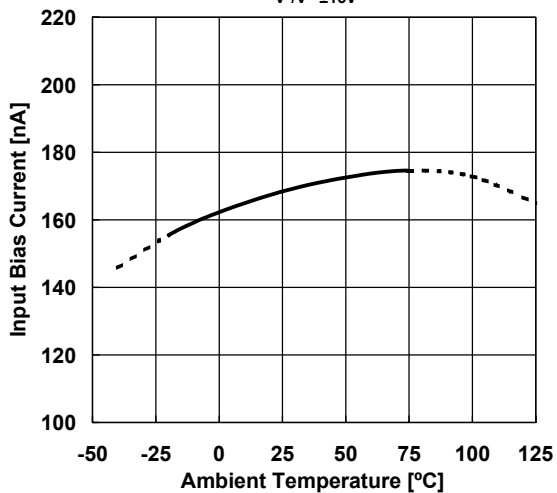

Maximum Output Voltage vs. Temperature
 $V^+/V^-=\pm 15V, R_L=2k\Omega$

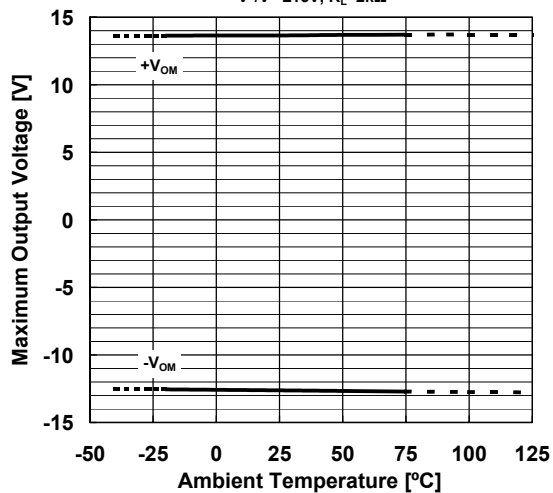

Maximum Output Voltage vs. Supply Voltage
 $T_a=25^\circ C$

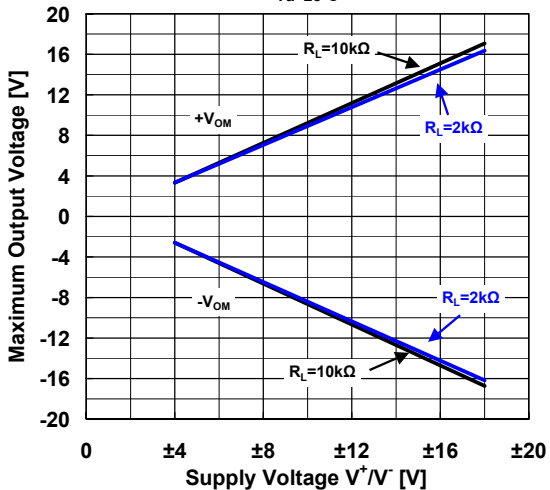

■ TEST CIRCUIT

Noise Voltage (RIAA) measurement circuit

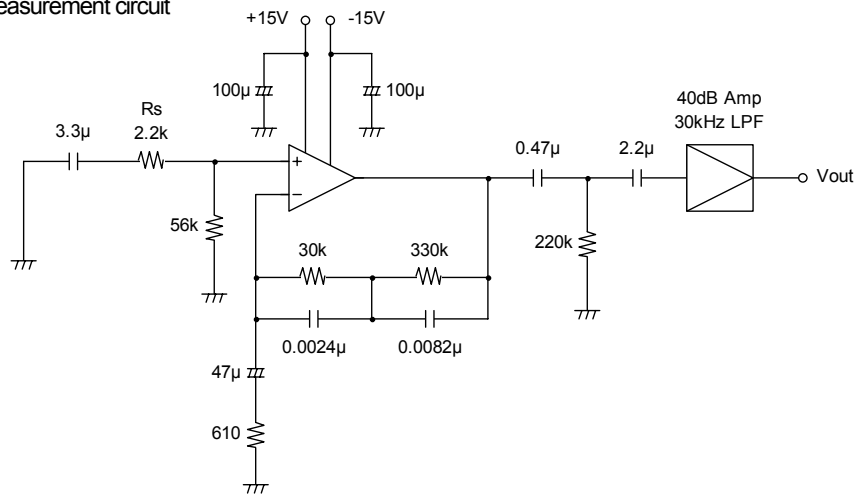

[CAUTION]

The specifications on this databook are only given for information, without any guarantee as regards either mistakes or omissions. The application circuits in this databook are described only to show representative usages of the product and not intended for the guarantee or permission of any right including the industrial rights.

Mouser Electronics

Authorized Distributor

Click to View Pricing, Inventory, Delivery & Lifecycle Information:

[NJR:](#)

[NJM2068D](#) [NJM2068M](#) [NJM2068L](#) [NJM2068E](#) [NJM2068MD](#) [NJM2068DD](#) [NJM2068MD-TE2](#) [NJM2068MD-TE3](#)
[NJM2068MD-TE1](#) [NJM2068V-TE1](#) [NJM2068V-TE2](#) [NJM2068M-TE1](#) [NJM2068M-TE3](#) [NJM2068M-TE2](#) [NJM2068E-TE2](#) [NJM2068E-TE1](#)