

## 3.3V 35A Quarter Brick Converter

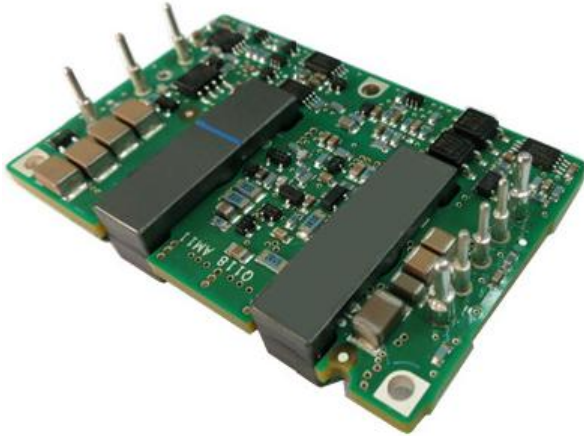

### Features

- High efficiency, 91% (3.3V/35A )
- Excellent thermal performance
- Over-voltage, over-current, short-circuit, and over temperature protection
- Monotonic start-up
- No minimum load required
- Fixed frequency operation
- Basic Insulation
- UL 60950-1 2<sup>nd</sup> recognized†

### Options

- Baseplate
- Auto-restart after fault shutdown
- Negative / Positive enable logic
- Case ground pin
- Various lead lengths

### Part Numbering System

Series Name	Input Voltage	Output Voltage	ON/OFF Logic	Output Current	Pin Feature	Electrical Options	Mechanical Options
QRS	4	033	N	035	N	2	6
QRS	4: 36-75V	Unit: 0.1V 033: 3.3V	P: positive N: negative	Unit: A 035:35A	Regular K: 0.110" N: 0.145" R: 0.180" S: SMT*	0: latch up 1: parallel 2: auto-restart	5: open frame 6: baseplate 8: baseplate with case pin

\*: SMT pins are metal block pins at the same locations as the through-hole pins. The recommended diameter for pad/stencil opening and solder mask opening for these pins is 0.12".

### Absolute Maximum Ratings

Excessive stresses over these absolute maximum ratings can cause permanent damage to the converter. Operation should be limited to the conditions outlined under the Electrical Specification Section.

Parameter	Symbol	Min	Max	Unit
Input Voltage (continuous)	V <sub>i</sub>	-0.5	80	Vdc
Input Voltage (continuous, non-operating)	V <sub>i</sub>	-	100	Vdc
I/O Isolation Voltage		-	1,500	Vdc
Operating Ambient Temperature (See Thermal Consideration section)	T <sub>o</sub>	-40	85*	°C
Storage Temperature	T <sub>stg</sub>	-55	125	°C

\* Derating curves provided in this datasheet end at 85°C ambient temperature. Operation above 85°C ambient temperature is allowed provided the temperatures of the key components or the baseplate do not exceed the limit stated in the Thermal Considerations section.

† UL is a registered trademark of Underwriters Laboratory Inc.



## Electrical Specifications

These specifications are valid over the converter's full range of input voltage, resistive load, and temperature unless noted otherwise.

### Input Specifications

Parameter	Symbol	Min	Typ	Max	Unit
Input Voltage	$V_i$	36	48	75	Vdc
Input Current	$I_{i,max}$	-	-	4	A
Quiescent Input Current (Typical $V_{in}$ )	$I_{i,Qsnt}$	-	70	110	mA
Standby Input Current	$I_{i,stdby}$	-	4	6	mA
Input Reflected-ripple Current, Peak-to-peak (5 Hz to 20 MHz, 12 $\mu$ H source impedance)	-	-	7	-	mA
Input Ripple Rejection (120 Hz)	-	-	60	-	dB
Input Turn-on Voltage Threshold	-	34	35	36	V
Input Turn-off Voltage Threshold	-	29	32	34	V
Input Voltage ON/OFF Hysteresis	-	1	3	4	V

### Output Specifications

Parameter	Symbol	Min	Typ	Max	Unit
Output Voltage Set Point (Typical $V_{in}$ ; $I_o = I_{o,max}$ ; $T_a = 25^\circ\text{C}$ )	-	3.25	3.3	3.35	Vdc
Output Voltage Set Point (over all conditions)	-	3.2	-	3.4	Vdc
Output Regulation:					
Line Regulation (Over full input range, $I_o = 1/2$ of load)	-	-	0.05	0.2	% $V_o$
Load Regulation ( $I_o = I_{o,min}$ to $I_{o,max}$ , typical $V_{in}$ )	-	-	0.05	0.2	% $V_o$
Temperature ( $T_a = -40^\circ\text{C}$ to $85^\circ\text{C}$ )	-	-	15	50	mV
Output Ripple and Noise Voltage RMS	-	-	-	30	mVrms
Peak-to-peak (5 Hz to 20 MHz bandwidth, $V_{in} = 48\text{V}$ )	-	-	-	90	mVp-p
External Load Capacitance	-	-	-	30,000	$\mu\text{F}$
Output Current	$I_o$	0	-	35	A
Output Power	$P_o$	0	-	115.5	W
Startup Delay (from enabling to $V_o$ reaching 10% of set point. Typical $V_{in}$ ; $I_o = I_{o,max}$ , $T_a = 25^\circ\text{C}$ )			3		ms
Startup Time ( $V_o$ from 10% to 90% of output set point. $I_o = I_{o,min}$ , $T_a = 25^\circ\text{C}$ )			4		ms
Output Over Current Protection trip point	$I_{o,cli}$	36	39	45	A
Output Over Voltage trip point		3.8	4.2	4.6	V
Output ripple frequency	-	290	310	330	kHz
Dynamic Response (Typical $V_{in}$ ; $T_a = 25^\circ\text{C}$ ; Load transient 0.1A/ $\mu\text{s}$ )					
Load step from 50% to 75% of full load:					
Peak deviation			4		% $V_o$
Settling time (to 10% band of $V_o$ deviation)			200		$\mu\text{s}$
Load step from 50% to 25% of full load:					
Peak deviation			4		% $V_o$
Settling time (to 10% band of $V_o$ deviation)			200		$\mu\text{s}$



## General Specifications

Parameter	Symbol	Min	Typ	Max	Unit
Remote Enable Logic Low:					
ION/OFF = 1.0mA	VON/OFF	0	-	1.2	V
VON/OFF = 0.0V	ION/OFF	-	-	1.0	mA
Logic High:					
ION/OFF = 0.0μA	VON/OFF	-	-	15	V
Leakage Current	ION/OFF	-	-	50	μA
Output Voltage Trim Range	-	80	-	110	%Vo
Isolation Capacitance	-	-	5600	-	pF
Isolation Resistance	-	10	-	-	MΩ
Calculated MTBF (Telecordia SR-332, 2011, Issue 3), full load, 40°C, 60% upper confidence level, typical Vin			9.6		10 <sup>6</sup> -hour

## Characteristic Curves

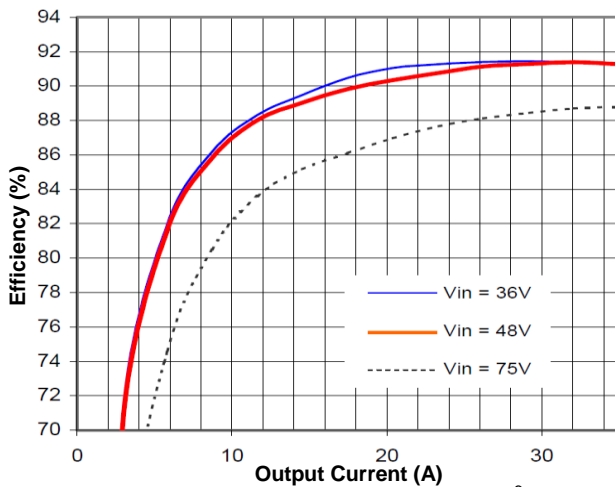

Figure 1. Efficiency vs. Load Current (25°C)

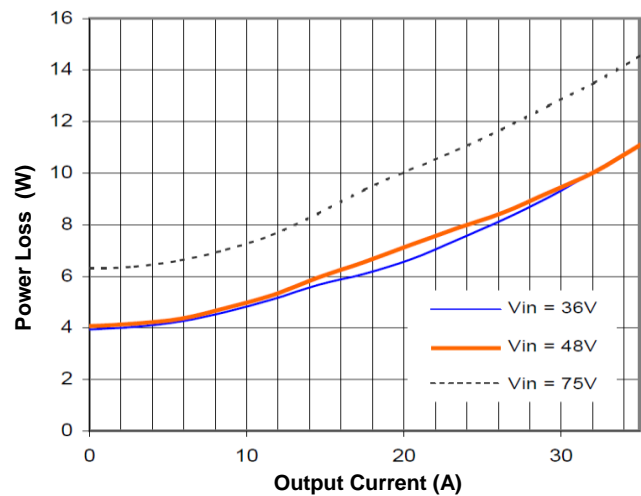

Figure 2. Power Loss vs. Load Current (25°C)

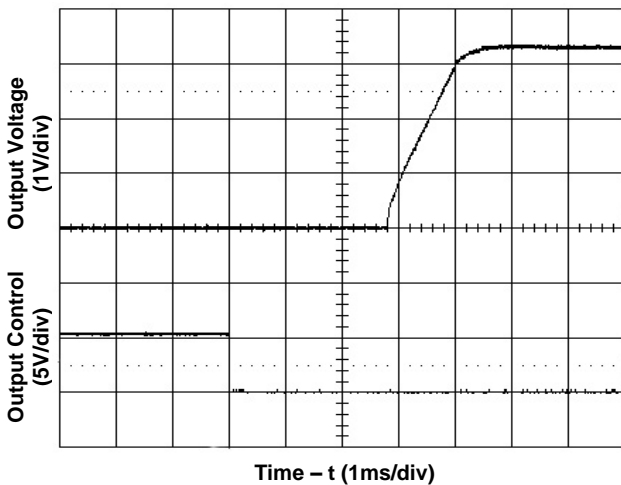

Figure 3. Start-Up from Enable Control  
Input voltage 48V, Output current 35A

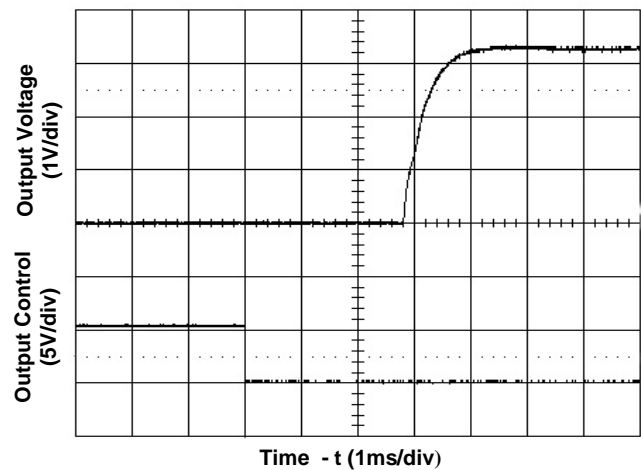

Figure 4. Start-Up from Enable Control  
Input voltage 48V, Output current 0A

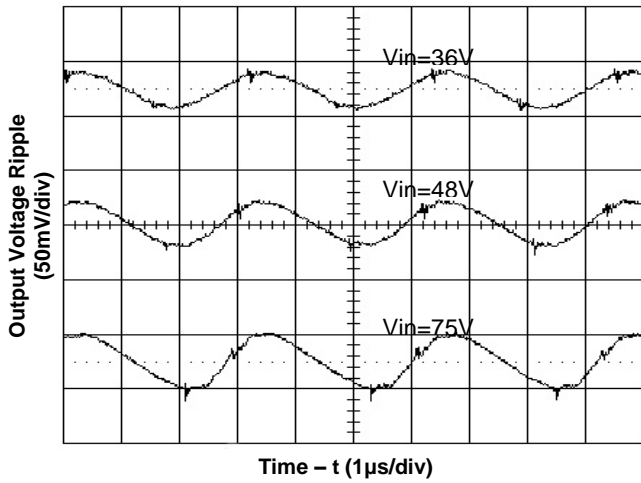

Figure 5. Output Ripple Voltage at Full Load

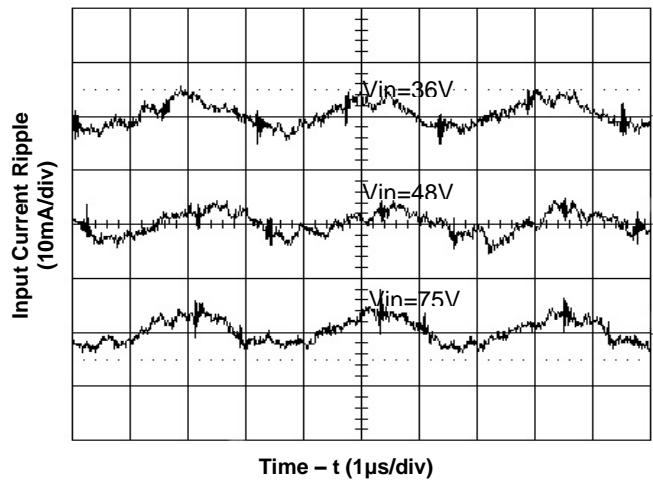

Figure 6. Input Reflected Ripple Current at Full Load

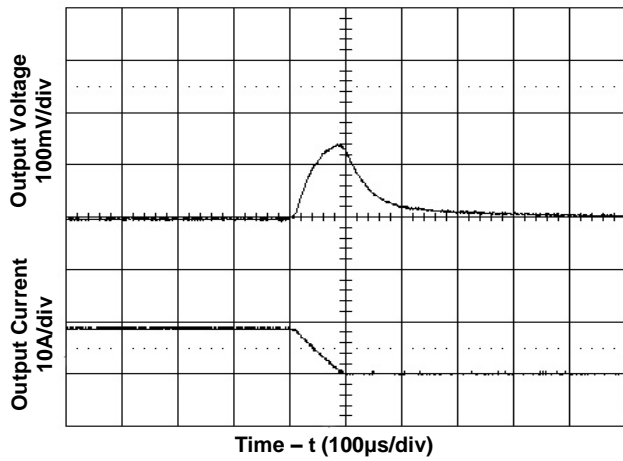

Figure 7. Transient Load Response  
 Top: Output voltage deviation  
 Bottom: Load current step (-25% full load)  
 Test Cond.: Output current at 20A 50% full load, typical  $V_{in}$ , slew rate 0.1A/ $\mu$ s

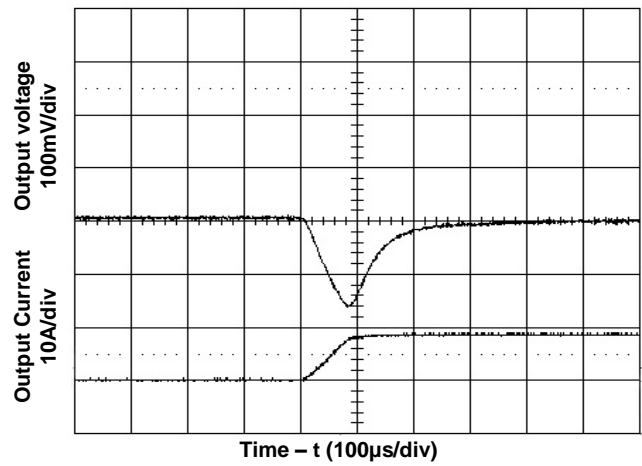

Figure 8. Transient Load Response  
 Top: Output voltage deviation  
 Bottom: Load current step (+25% full load)  
 Test Cond.: Output current at 20A 50% full load, typical  $V_{in}$ , slew rate 0.1A/ $\mu$ s

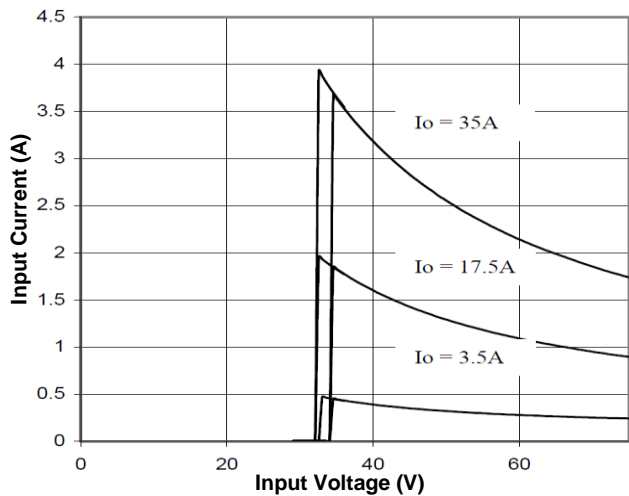

Figure 9. Input Characteristics

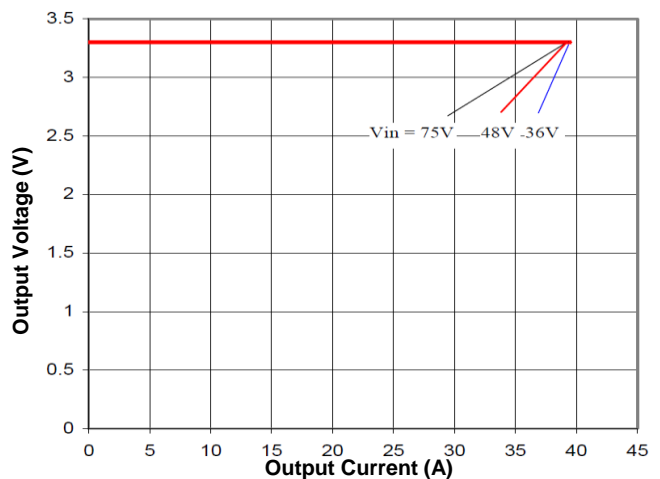
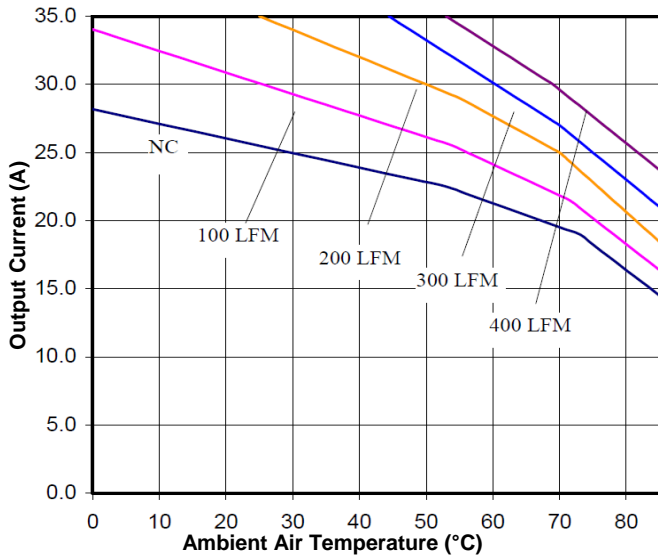
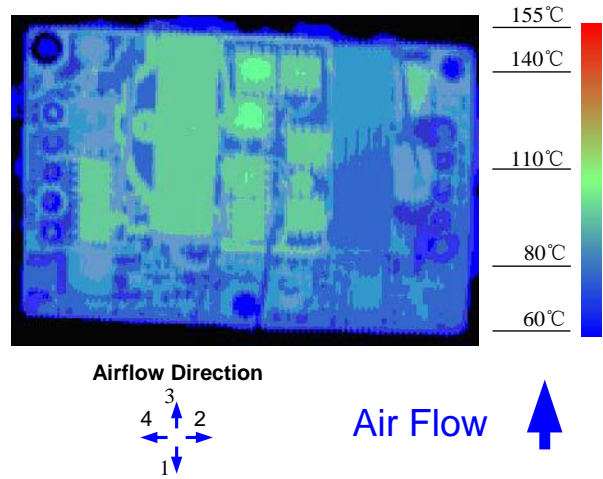

Figure 10. Output Characteristics



**Figure 11.** Current Derating Curve for Airflow Direction 3  
(Ref. Fig. 12 for Airflow Direction; typical Vin, open frame unit using soldering interface)



**Figure 12.** Thermal Image for Airflow Direction 3  
(28A output, 55°C ambient, 200 LFM, typical Vin, open frame unit using soldering interface)

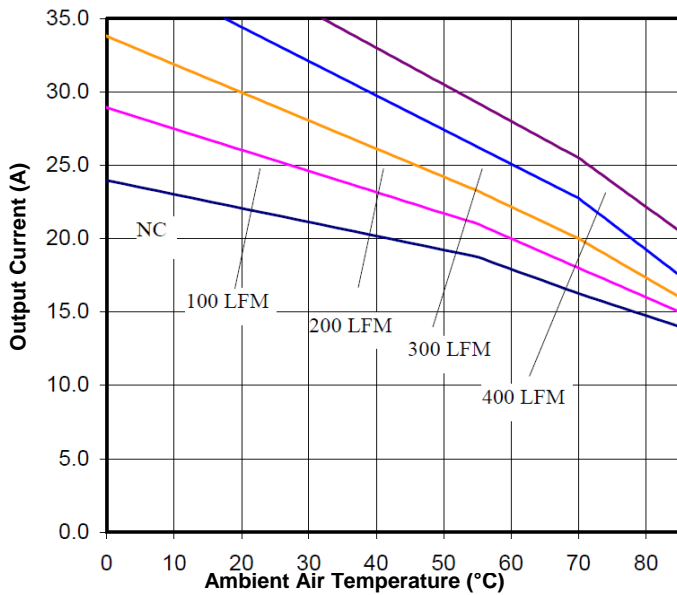

**Figure 13.** Current Derating Curve for Airflow Direction 4  
(Ref. Fig. 14 for Airflow Direction; typical Vin, open frame unit using soldering interface)

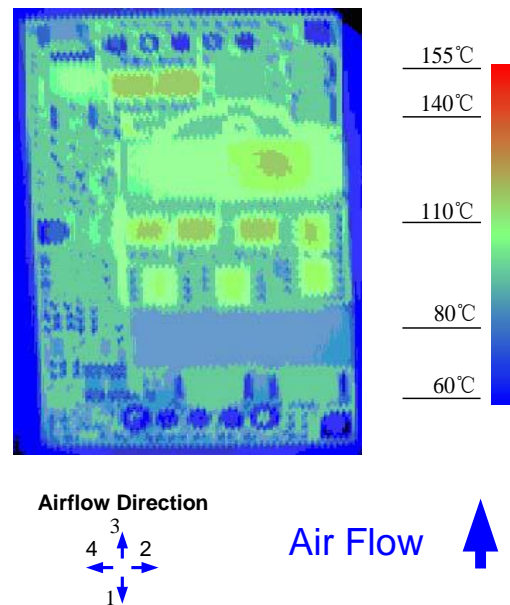

**Figure 14.** Thermal Image for Airflow Direction 4  
(23A output, 55°C ambient, 200 LFM, typical Vin, open frame unit using soldering interface)

## Feature Descriptions

### Remote ON/OFF

The converter can be turned on and off by changing the voltage or resistance between the ON/OFF pin and Vin(-). The QRS4 Series of converters is available with factory selectable positive logic or negative enabling logic.

For the negative control logic, the converter is ON when the ON/OFF pin is at a logic low level and OFF when the ON/OFF pin is at a logic high level. With positive control logic, the converter is ON when the ON/OFF pin is at a logic high level and OFF when the ON/OFF pin is at a logic low level.

With the internal pull-up circuitry, a simple external switch between the ON/OFF pin and Vin(-) can control the converter. A few example circuits for controlling the ON/OFF pin are shown in Figures 15, 16 and 17.

The logic low level is from 0V to 1.2V and the maximum sink current during logic low is 1mA. The external switch must be capable of maintaining a logic-low level while sinking up to this current. The logic high level is from 3.5V to 15V. The converter has an internal pull-up circuit that ensures the ON/OFF pin at a high logic level when the leakage current at ON/OFF pin is no greater than 50μA.

### Remote SENSE

The remote SENSE pins are used to sense voltage at the load point to accurately regulate the load voltage and eliminate the impact of the voltage drop in the power distribution path.

SENSE(+) and SENSE(-) pins should be connected between the points where voltage regulation is desired. The voltage between the SENSE pins and the output pins must not exceed the smaller of 0.5V or 10% of typical output voltage.

$$[V_{out(+)} - V_{out(-)}] - [SENSE(+)- SENSE (-)] < \text{MIN}\{0.5V, 10\%V_o\}$$

When remote sense is not used, the SENSE pins should be connected to their corresponding output pins. If the SENSE pins are left floating, the converter will deliver an output voltage slightly higher than its specified typical output voltage.

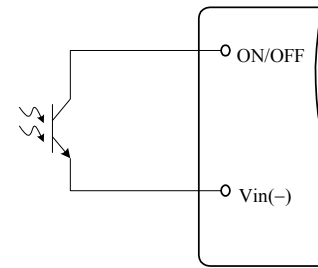

Figure 15. Opto Coupler Enable Circuit

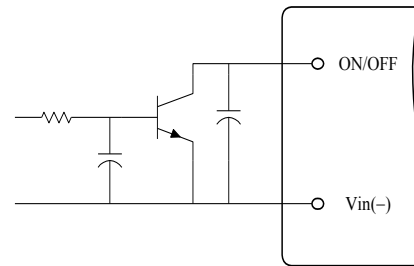

Figure 16. Open Collector Enable Circuit

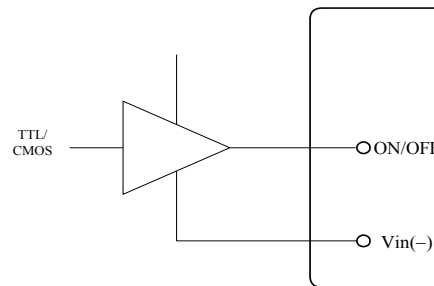

Figure 17. Direct Logic Drive

### Output Voltage Adjustment (Trim)

The trim pin allows the user to adjust the output voltage set point. To increase the output voltage, an external resistor is connected between the TRIM pin and SENSE(+). To decrease the output voltage, an external resistor is connected between the TRIM pin and SENSE(-). The output voltage trim range is 80% to 110% of its specified nominal output voltage. The circuit configuration for trim down operation is shown in Figure 18.

To decrease the output voltage, the value of the external resistor should be

$$R_{down} = \left( \frac{511}{\Delta} - 10.22 \right) (k\Omega)$$



Where

$$\Delta = \left( \frac{|V_{nom} - V_{adj}|}{V_{nom}} \right) \times 100$$

and

$V_{nom}$  = Typical Output Voltage

$V_{adj}$  = Adjusted Output Voltage

The circuit configuration for trim up operation is shown in Figure 19. To increase the output voltage, the value of the resistor should be

$$R_{up} = \left( \frac{5.11V_o(100 + \Delta)}{1.225\Delta} - \frac{511}{\Delta} - 10.22 \right) (k\Omega)$$

Where  $V_o$  = Typical Output Voltage

When using the trim up function, the output power goes up for the same output current. It is important not to exceed the maximum power rating of the converter as given in the Specifications table.

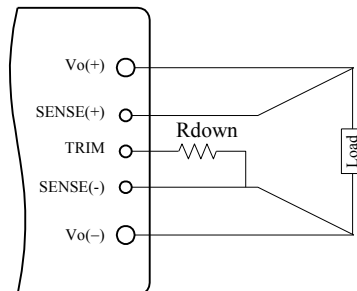

Figure 18. Circuit to Decrease Output Voltage

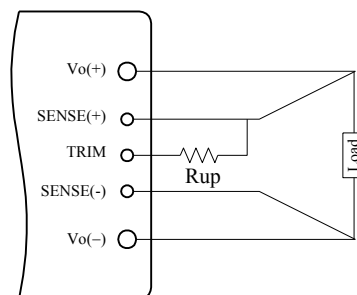

Figure 19. Circuit to Increase Output Voltage

### Active Current Share (Parallel)

Parallel/Case pin is designed for either active current share among modules in parallel or for grounding the baseplate (case).

The active current share feature allows multiple converters to share load current. For the parallel operation of multiple converters, The Parallel pin on each converter should be connected together. It is suggested to have a ground plane on the system board for  $V_{in}(-)$  to reduce the ground noise impact on the current share accuracy. The loop formed by the trace connecting the Parallel pins and the ground trace should be minimized to avoid noise coupling into the current share circuitry. A typical current share scheme for the QRS4 series of converters is shown in Fig. 20.

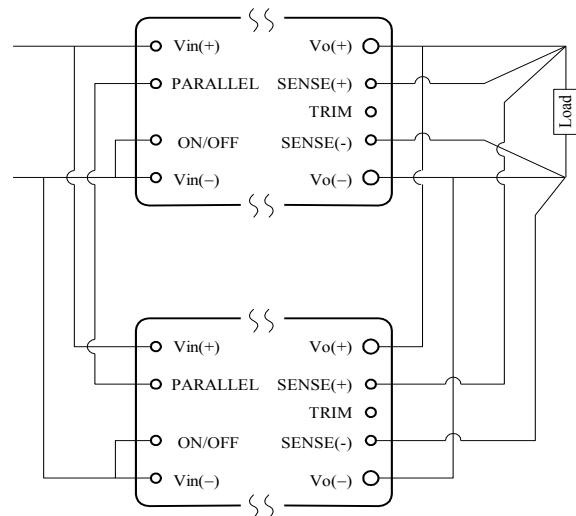

Fig. 20 Circuit Configuration for Active Current Share

### Input Under-Voltage Lockout

This feature prevents the converter from starting until the input voltage reaches the turn-on voltage threshold, and keeps the converter running until the input voltage falls below the turn-off voltage threshold. Both turn-on and turn-off voltage thresholds are defined in the Input Specifications table. The hysteresis prevents oscillations.

### Output Over-Current Protection (OCP)

This converter can be ordered in either latch-off or auto-restart version upon OCP, OVP, and OTP.

With the latch-off version, the converter will latch off when the load current exceeds the limit. The converter can be restarted by toggling the ON/OFF switch or recycling the input voltage.

With the auto-restart version, the converter will operate in a hiccup mode (repeatedly try to restart) until the cause of the over-current condition is cleared.

### Output Over-Voltage Protection (OVP)

With the latch-off version, the converter will latch off when the output voltage exceeds the limit. The converter can be restarted by toggling the ON/OFF switch or recycling the input voltage.

With the auto-restart version, the converter will operate in a hiccup mode (repeatedly try to restart) until the cause of the over-voltage condition is cleared.

### Over Temperature Protection (OTP)

With the latch-off version, the converter will shut down and latch off if an over-temperature condition is detected. The converter has a temperature sensor located at a carefully selected position in the converter circuit board, which represents the thermal condition of key components of the converter. The thermal shutdown circuit is designed to turn the converter off when the temperature at the sensor reaches 120°C. The module can be restarted by toggling the ON/OFF switch or recycling the input voltage.

With the auto-restart version, the converter will resume operation after the converter cools down.

## Design Considerations

As with any DC/DC converter, the stability of the QRS4 converters may be compromised if the source impedance is too high or inductive. It's desirable to keep the input source ac-impedance as low as possible. Although the converters are designed to be stable without adding external input capacitors for typical source impedance, it is recommended to add 100  $\mu$ F low ESR electrolytic capacitors at the input of the converter for each 100W output power, which reduces the potential negative impact of the source impedance on the converter stability. These electrolytic capacitors should have sufficient RMS current rating over the operating temperature range.

The converter is designed to be stable without additional output capacitors. To further reduce the output voltage ripple or improve the transient response, additional output capacitors are often used in applications. When additional output capacitors are used, a combination of ceramic capacitors and tantalum/polymer capacitors shall be used to provide good filtering while assuring the stability of the converter.

## Safety Considerations

The QRS4 Series of converters are designed in accordance with EN 60950 Safety of Information Technology Equipment Including Electrical Equipment. The converters are recognized by UL in both USA and Canada to meet the requirements in UL 60950, Safety of Information Technology Equipment and applicable Canadian Safety Requirement, and ULc 60950. Flammability ratings of the PWB and plastic components in the converter meet 94V-0.

To protect the converter and the system, an input line fuse is highly recommended on the un-grounded input end.

## Thermal Considerations

The QRS4 Series of converters can operate in various thermal environments. Due to the high efficiency and optimal heat distribution, these converters exhibit excellent thermal performance.

The maximum allowable output power of any power converter is usually determined by the electrical design and the maximum operating temperature of its components. The QRS4 Series of converters have been tested comprehensively under various conditions to generate the derating curves with the consideration for long term reliability.

The thermal derating curves are highly influenced by the test conditions. One of the critical variables is the interface method between the converter and the test fixture board. There is no standard method in the industry for the derating tests. Some suppliers use sockets to plug in the converter, while others solder the converter into the fixture board. It should be noticed that these two methods produce significantly



different results for a given converter. When the converter is soldered into the fixture board, the thermal performance of the converter is significantly improved compared to using sockets due to the reduction of the contact loss and the thermal impedance from the pins to the fixture board. Other factors affecting the results include the board spacing, construction (especially copper weight, holes and openings) of the fixture board and the spacing board, temperature measurement method and ambient temperature measurement point. The thermal derating curves in this datasheet are obtained using a PWB fixture board and a PWB spacing board with no opening, a board-to-board spacing of 1", and the converter is soldered to the test board with thermal relieves.

Note that the natural convection condition was measured at 0.05 m/s to 0.15 m/s (10ft./min. to 30 ft./min).

#### Heat Transfer without a Baseplate

With single-board DC/DC converter designs, convection heat transfer is the primary cooling means for converters without a baseplate. Therefore, airflow speed should be checked carefully for the intended operating environment. Increasing the airflow over the converter enhances the heat transfer via convection.

Figure 21 shows a recommended temperature monitoring point for open frame modules. For reliable operation, the temperature at this location should not continuously exceed 120 °C.

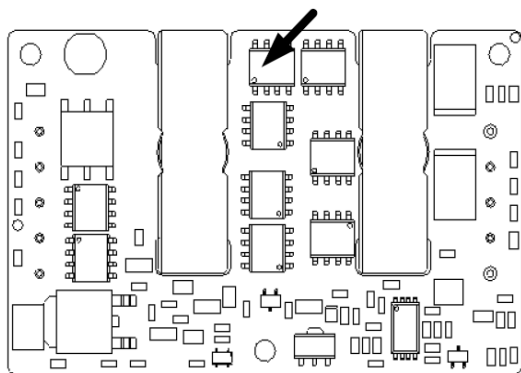

**Figure 21.** Temperature Monitoring Location

#### Heat Transfer with a Baseplate

The QRS4 Series of converters have the options of using a baseplate for enhanced thermal performance.

The typical height of the converter with the baseplate option is 0.50". The use of an additional heatsink or cold-plate can further improve the thermal performance of the converter. With the baseplate option, a standard quarter-brick heatsink can be attached to the converter using M3 screws.

For reliable operation, the baseplate temperature should not continuously exceed 100 °C.

#### EMC Considerations

The EMC performance of the converter is related to the layout and filtering design of the customer board. Careful layout and adequate filtering around the converter are important to confine noise generated by the switching actions in the converter and to optimize system EMC performance.



**Mechanical Information**

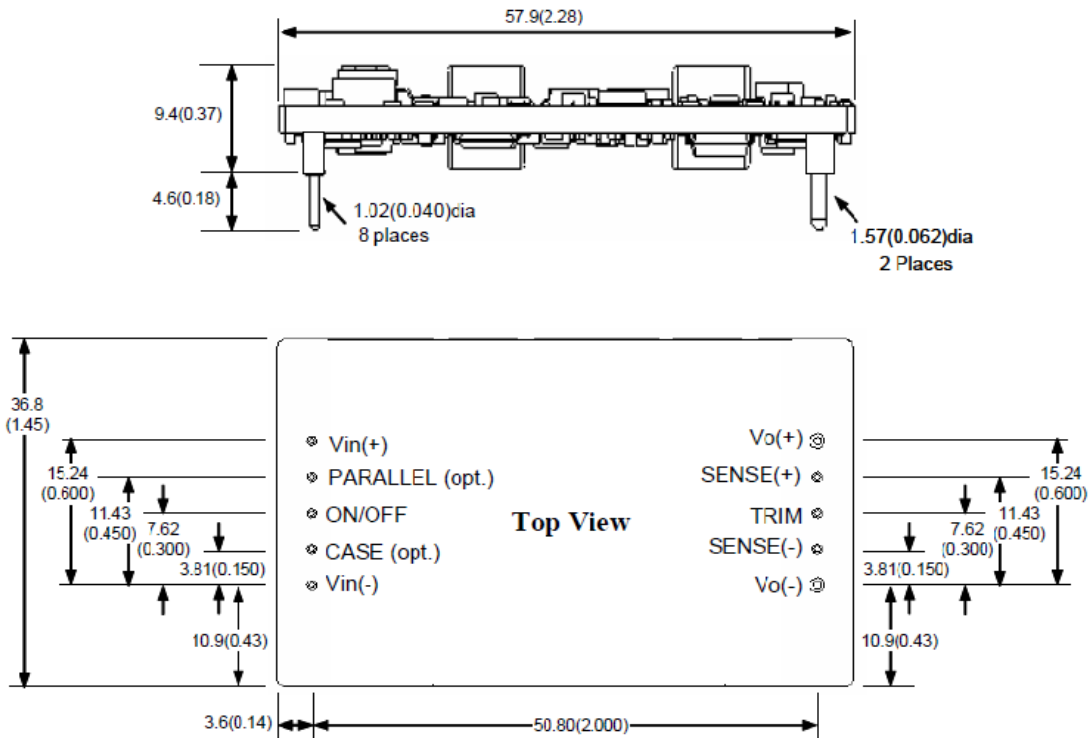
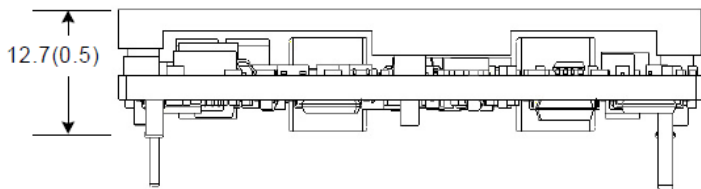

Figure 22. Open frame converter

**Side View**



**Notes**

- 1) All dimensions in mm (inches)  
Tolerances: .x ± .5 (.xx ± 0.02)  
.xx ± .25 (.xxx ± 0.010)
- 2) Regular input and function pins are 1.02mm (0.040") dia. with +/- 0.10mm (0.004") tolerance; the standoff shoulders are 2.00mm (0.078") dia. with +/- 0.15mm (0.006") tolerance.
- 3) Output pins are 1.57 mm (0.062") dia. with +/- 0.10mm (0.004") tolerance; the standoff shoulders are 2.46mm (0.097") dia. with +/- 0.15mm (0.006") tolerance.
- 4) All pins are coated with 90%/10% solder, Gold, or Matte Tin finish with Nickel under plating.
- 5) Weight: 38 g open frame converter
- 6) Workmanship meets or exceeds IPC-A-610 Class II
- 7) Torque applied on screw should not exceed 6in-lb. (0.7 Nm)
- 8) Baseplate flatness tolerance is 0.10mm (0.004") TIR for surface
- 9) If M3 screws are used to attach a heatsink to the baseplate, the screw length from the top surface of baseplate going down should not exceed 3.8 mm (0.15 in) max .

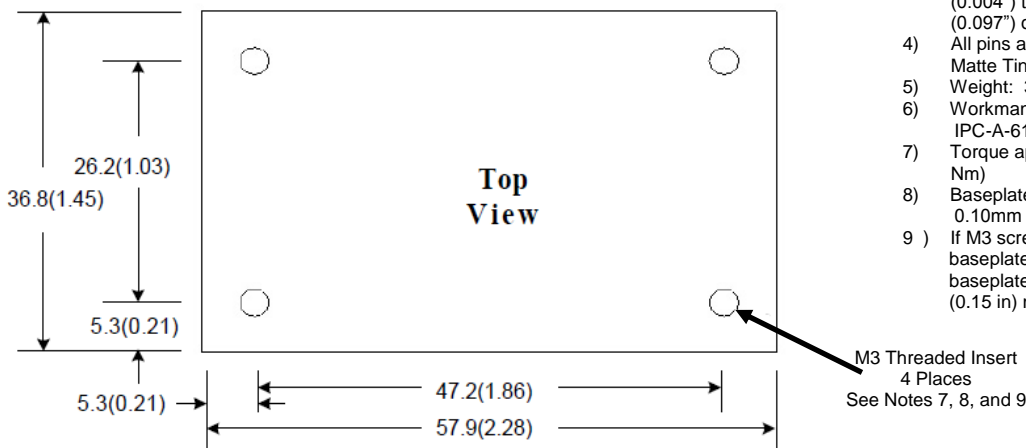

Figure 23. Converter with a baseplate

# Mouser Electronics

Authorized Distributor

Click to View Pricing, Inventory, Delivery & Lifecycle Information:

[NetPower Technologies:](#)

[QRS4033N035R25](#)