

LME49720 Dual High Performance, High Fidelity Audio Operational Amplifier

Check for Samples: [LME49720](#)

FEATURES

- Easily drives 600Ω loads
- Optimized for superior audio signal fidelity
- Output short circuit protection
- PSRR and CMRR exceed 120dB (typ)
- SOIC, DIP, TO-99 metal can packages

APPLICATIONS

- Ultra high quality audio amplification
- High fidelity preamplifiers
- High fidelity multimedia
- State of the art phono pre amps
- High performance professional audio
- High fidelity equalization and crossover networks
- High performance line drivers
- High performance line receivers
- High fidelity active filters

DESCRIPTION

The LME49720 is part of the ultra-low distortion, low noise, high slew rate operational amplifier series optimized and fully specified for high performance, high fidelity applications. Combining advanced leading-edge process technology with state-of-the-art circuit design, the LME49720 audio operational amplifiers deliver superior audio signal amplification for outstanding audio performance. The LME49720 combines extremely low voltage noise density (2.7nV/√Hz) with vanishingly low THD+N (0.00003%) to easily satisfy the most demanding audio applications. To ensure that the most challenging loads are driven without compromise, the LME49720 has a high slew rate of ±20V/μs and an output current capability of ±26mA. Further, dynamic range is maximized by an output stage that drives 2kΩ loads to within 1V of either power supply voltage and to within 1.4V when driving 600Ω loads.

The LME49720's outstanding CMRR (120dB), PSRR (120dB), and V_{OS} (0.1mV) give the amplifier excellent operational amplifier DC performance.

The LME49720 has a wide supply range of ±2.5V to ±17V. Over this supply range the LME49720's input circuitry maintains excellent common-mode and power supply rejection, as well as maintaining its low input bias current. The LME49720 is unity gain stable. This Audio Operational Amplifier achieves outstanding AC performance while driving complex loads with values as high as 100pF.

The LME49720 is available in 8-lead narrow body SOIC, 8-lead Plastic DIP, and 8-lead Metal Can TO-99. Demonstration boards are available for each package.

Table 1. Key Specifications

	VALUE	UNIT
■ Power Supply Voltage Range	±2.5 to ±17	V
■ THD+N ($A_V = 1$, $V_{OUT} = 3V_{RMS}$, $f_{IN} = 1kHz$)		
$R_L = 2k\Omega$	0.00003% (typ)	
$R_L = 600\Omega$	0.00003% (typ)	
■ Input Noise Density	2.7nV/√Hz (typ)	
■ Slew Rate	±20V/μs (typ)	
■ Gain Bandwidth Product	55	MHz (typ)
■ Open Loop Gain ($R_L = 600\Omega$)	140	dB (typ)
■ Input Bias Current	10nA (typ)	
■ Input Offset Voltage	0.1mV (typ)	



Please be aware that an important notice concerning availability, standard warranty, and use in critical applications of Texas Instruments semiconductor products and disclaimers thereto appears at the end of this data sheet.

All trademarks are the property of their respective owners.

Table 1. Key Specifications (continued)

	VALUE	UNIT
■ DC Gain Linearity Error	0.000009%	

Typical Application

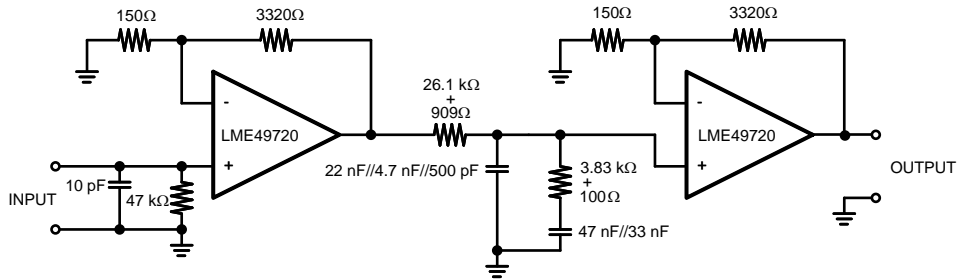

Note: 1% metal film resistors, 5% polypropylene capacitors

Figure 1. Passively Equalized RIAA Phono Preamplifier

Connection Diagram

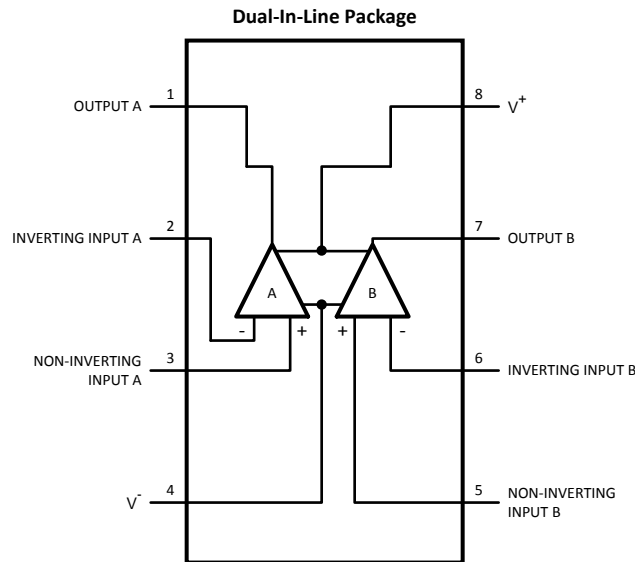
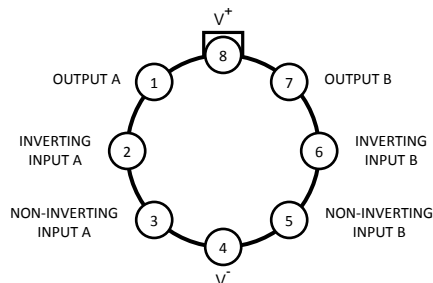

Figure 2. Dual-In-Line Package

Figure 3. Metal Can

These devices have limited built-in ESD protection. The leads should be shorted together or the device placed in conductive foam during storage or handling to prevent electrostatic damage to the MOS gates.

Absolute Maximum Ratings ⁽¹⁾ ⁽²⁾

Power Supply Voltage ($V_S = V^+ - V^-$)	36V
Storage Temperature	-65°C to 150°C
Input Voltage	(V^-) - 0.7V to (V^+) + 0.7V
Output Short Circuit (Note 3)	Continuous
Power Dissipation	Internally Limited
ESD Susceptibility (Note 4)	2000V
ESD Susceptibility (Note 5)	
Pins 1, 4, 7 and 8	200V
Pins 2, 3, 5 and 6	100V
Junction Temperature	150°C
Thermal Resistance	
θ_{JA} (SO)	145°C/W
θ_{JA} (NA)	102°C/W
θ_{JA} (HA)	150°C/W
θ_{JC} (HA)	35°C/W
Temperature Range	
$T_{MIN} \leq T_A \leq T_{MAX}$	-40°C \leq T_A \leq 85°C
Supply Voltage Range	$\pm 2.5V \leq V_S \leq \pm 17V$

(1) *Absolute Maximum Ratings* indicate limits beyond which damage to the device may occur.

(2) *Operating Ratings* indicate conditions for which the device is functional, but do not guarantee specific performance limits. For guaranteed specifications and test conditions, see the Electrical Characteristics. The guaranteed specifications apply only for the test conditions listed. Some performance characteristics may degrade when the device is not operated under the listed test conditions.

Electrical Characteristics for the LME49720 (1) (2)

The following specifications apply for $V_S = \pm 15V$, $R_L = 2k\Omega$, $f_{IN} = 1kHz$, and $T_A = 25^\circ C$, unless otherwise specified.

Symbol	Parameter	Conditions	LME49720		Units (Limits)
			Typical	Limit	
			(3)	(4)	
THD+N	Total Harmonic Distortion + Noise	$A_V = 1$, $V_{OUT} = 3V_{rms}$ $R_L = 2k\Omega$ $R_L = 600\Omega$	0.00003 0.00003	0.00009	% (max)
IMD	Intermodulation Distortion	$A_V = 1$, $V_{OUT} = 3V_{RMS}$ Two-tone, 60Hz & 7kHz 4:1	0.00005		%
GBWP	Gain Bandwidth Product		55	45	MHz (min)
SR	Slew Rate		± 20	± 15	V/ μs (min)
FPBW	Full Power Bandwidth	$V_{OUT} = 1V_{P-P}$, $-3dB$ referenced to output magnitude at $f = 1kHz$	10		MHz
t_s	Settling time	$A_V = -1$, 10V step, $C_L = 100pF$ 0.1% error range	1.2		μs
e_n	Equivalent Input Noise Voltage	$f_{BW} = 20Hz$ to 20kHz	0.34	0.65	μV_{RMS} (max)
	Equivalent Input Noise Density	$f = 1kHz$ $f = 10Hz$	2.7 6.4	4.7	nV/\sqrt{Hz} (max)
i_n	Current Noise Density	$f = 1kHz$ $f = 10Hz$	1.6 3.1		pA/\sqrt{Hz}
V_{OS}	Offset Voltage		± 0.1	± 0.7	mV (max)
$\Delta V_{OS}/\Delta Temp$	Average Input Offset Voltage Drift vs Temperature	$-40^\circ C \leq T_A \leq 85^\circ C$	0.2		$\mu V/^\circ C$
PSRR	Average Input Offset Voltage Shift vs Power Supply Voltage	$\Delta V_S = 20V$ (Note 8)	120	110	dB (min)
ISO _{CH-CH}	Channel-to-Channel Isolation	$f_{IN} = 1kHz$ $f_{IN} = 20kHz$	118 112		dB
I_B	Input Bias Current	$V_{CM} = 0V$	10	72	nA (max)
$\Delta I_{OS}/\Delta Temp$	Input Bias Current Drift vs Temperature	$-40^\circ C \leq T_A \leq 85^\circ C$	0.1		nA/ $^\circ C$
I_{OS}	Input Offset Current	$V_{CM} = 0V$	11	65	nA (max)
V_{IN-CM}	Common-Mode Input Voltage Range		+14.1 -13.9	(V+) - 2.0 (V-) + 2.0	V (min)
CMRR	Common-Mode Rejection	$-10V < V_{cm} < 10V$	120	110	dB (min)
Z_{IN}	Differential Input Impedance		30		k Ω
	Common Mode Input Impedance	$-10V < V_{cm} < 10V$	1000		M Ω
A_{VOL}	Open Loop Voltage Gain	$-10V < V_{out} < 10V$, $R_L = 600\Omega$	140	125	dB (min)
		$-10V < V_{out} < 10V$, $R_L = 2k\Omega$	140		
		$-10V < V_{out} < 10V$, $R_L = 10k\Omega$	140		
V_{OUTMAX}	Maximum Output Voltage Swing	$R_L = 600\Omega$	± 13.6	± 12.5	V (min)
		$R_L = 2k\Omega$	± 14.0		
		$R_L = 10k\Omega$	± 14.1		
I_{OUT}	Output Current	$R_L = 600\Omega$, $V_S = \pm 17V$	± 26	± 23	mA (min)
I_{OUT-CC}	Instantaneous Short Circuit Current		+53 -42		mA

(1) *Absolute Maximum Ratings* indicate limits beyond which damage to the device may occur.

(2) *Operating Ratings* indicate conditions for which the device is functional, but do not guarantee specific performance limits. For guaranteed specifications and test conditions, see the Electrical Characteristics. The guaranteed specifications apply only for the test conditions listed. Some performance characteristics may degrade when the device is not operated under the listed test conditions.

(3) Typical specifications are specified at $+25^\circ C$ and represent the most likely parametric norm.

(4) Tested limits are guaranteed to National's AOQL (Average Outgoing Quality Level).

Electrical Characteristics for the LME49720 ⁽¹⁾ ⁽²⁾ (continued)

The following specifications apply for $V_S = \pm 15V$, $R_L = 2k\Omega$, $f_{IN} = 1kHz$, and $T_A = 25^\circ C$, unless otherwise specified.

Symbol	Parameter	Conditions	LME49720		Units (Limits)
			Typical	Limit	
			(3)	(4)	
R_{OUT}	Output Impedance	$f_{IN} = 10kHz$ Closed-Loop Open-Loop	0.01 13		Ω
C_{LOAD}	Capacitive Load Drive Overshoot	100pF	16		%
I_S	Total Quiescent Current	$I_{OUT} = 0mA$	10	12	mA (max)

Typical Performance Characteristics

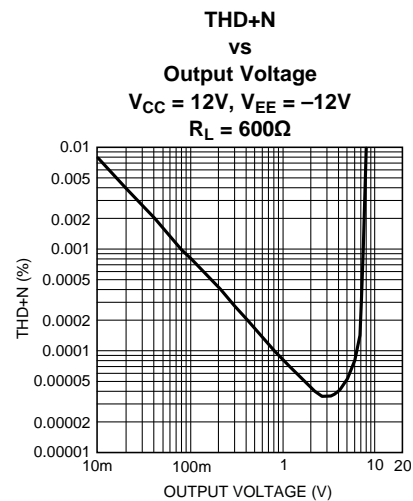
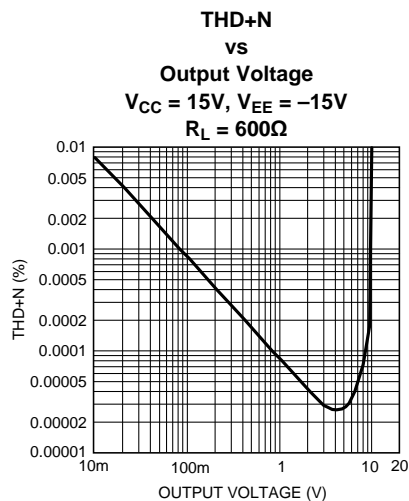
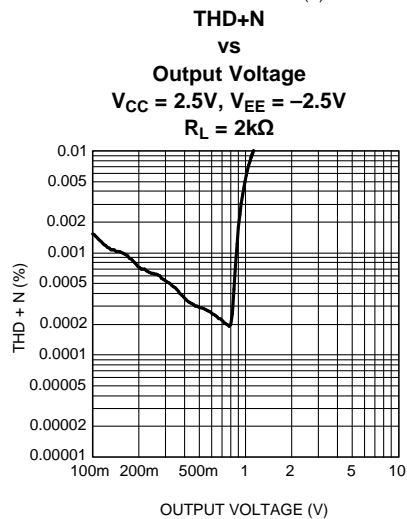
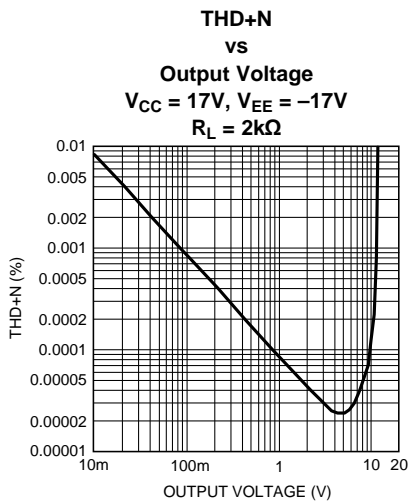
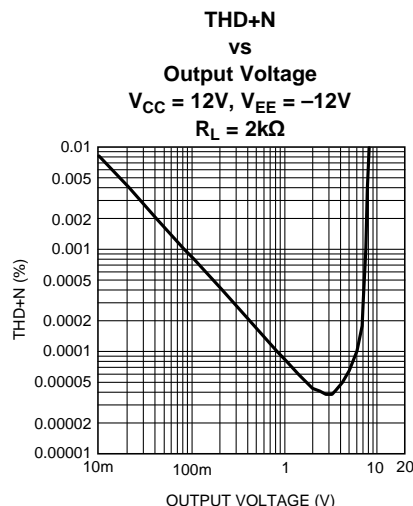
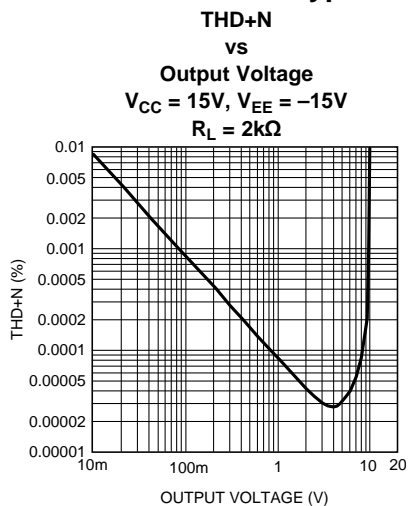

Typical Performance Characteristics (continued)

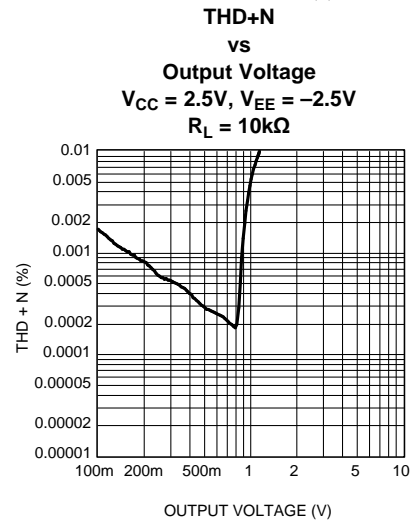
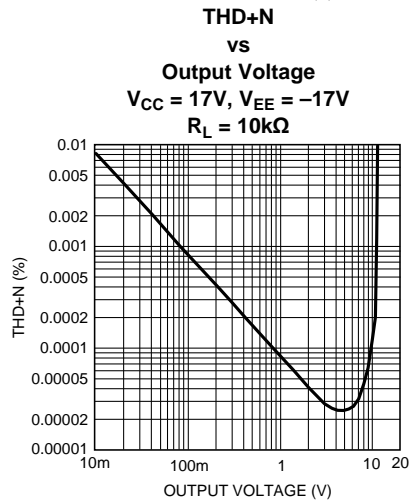
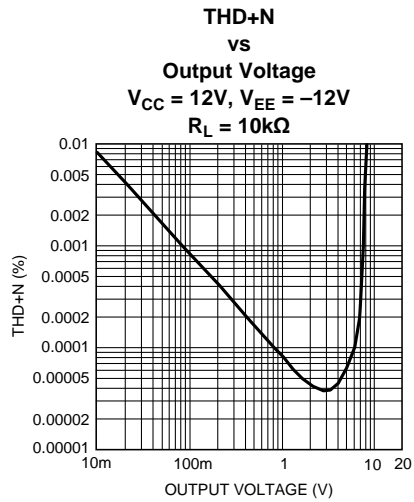
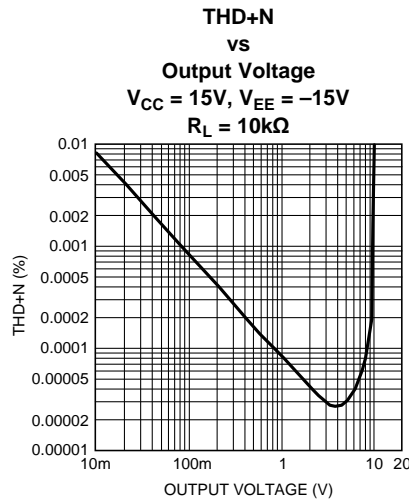
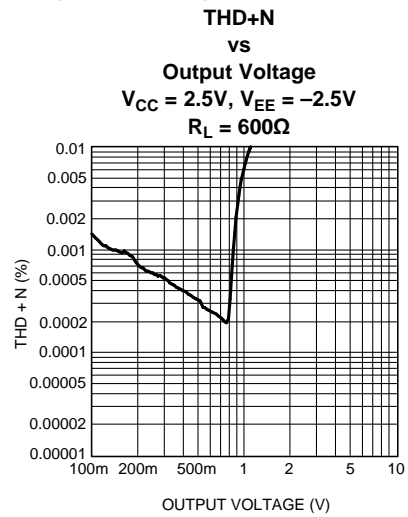
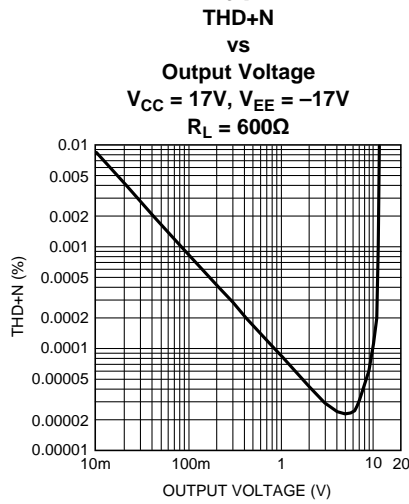

Typical Performance Characteristics (continued)

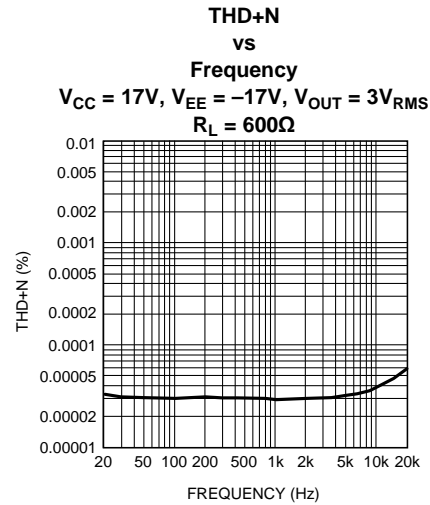
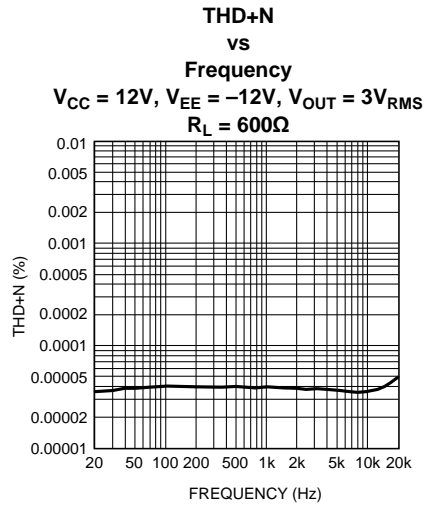
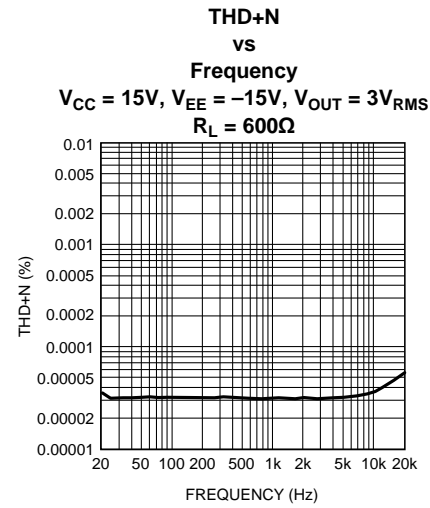
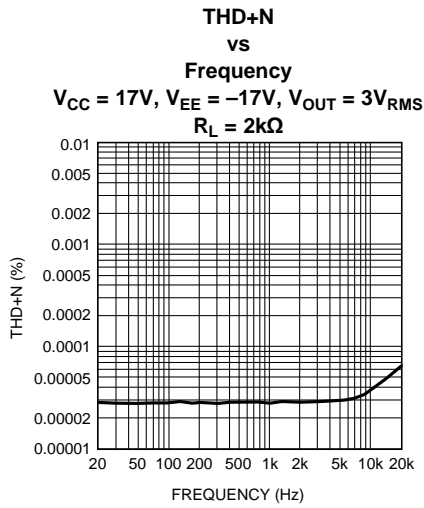
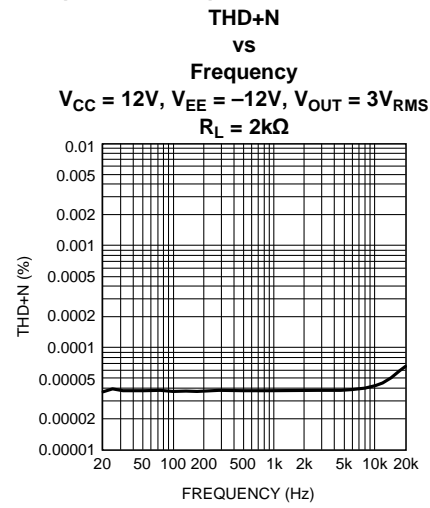
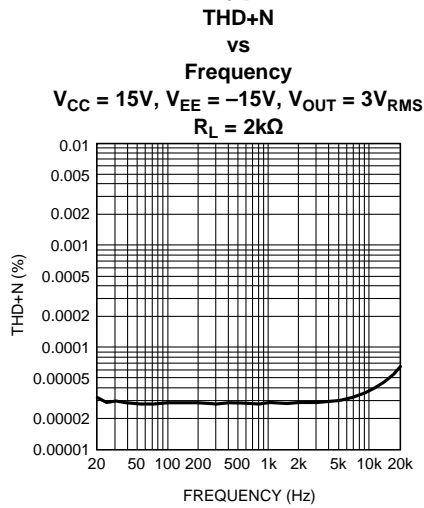

Typical Performance Characteristics (continued)

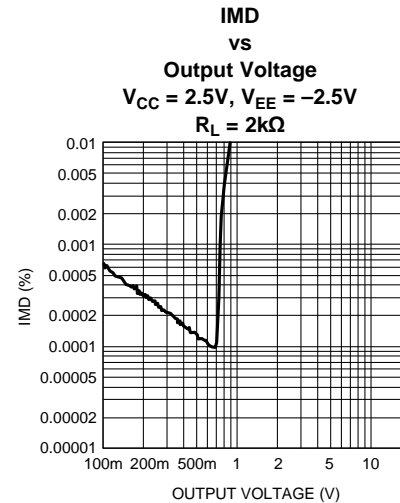
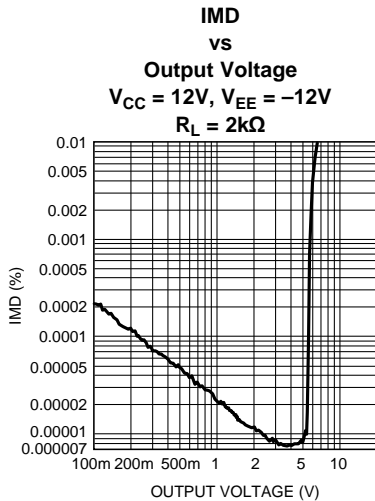
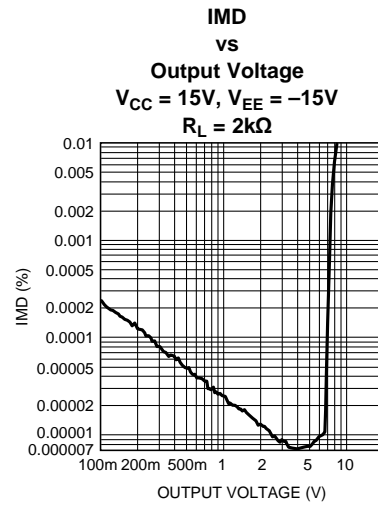
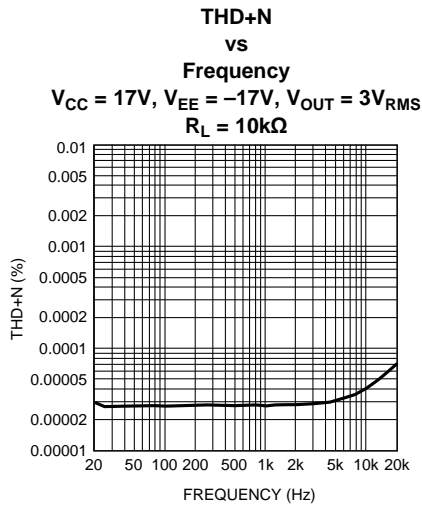
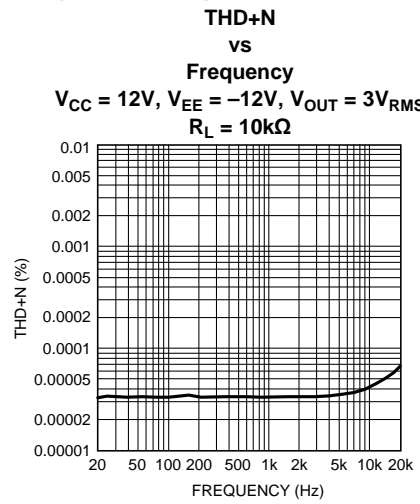
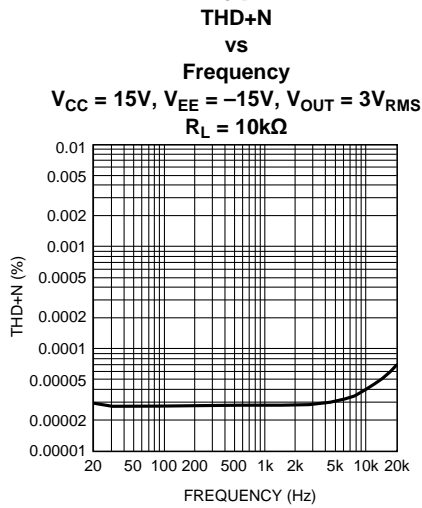

Typical Performance Characteristics (continued)

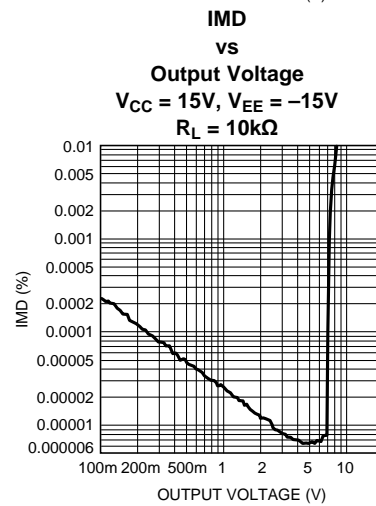
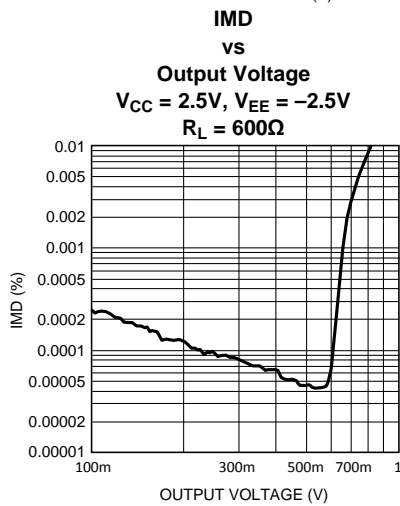
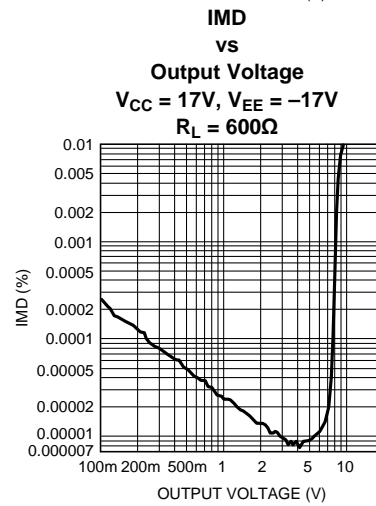
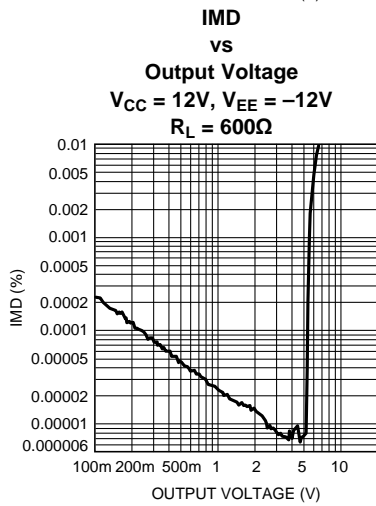
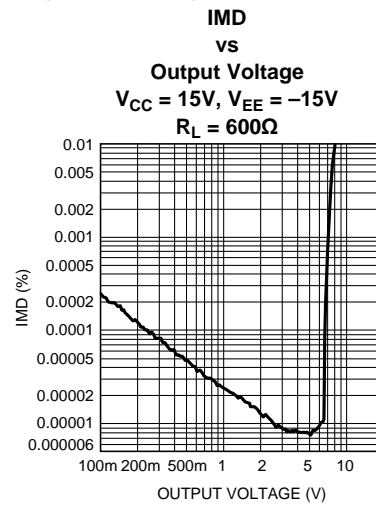
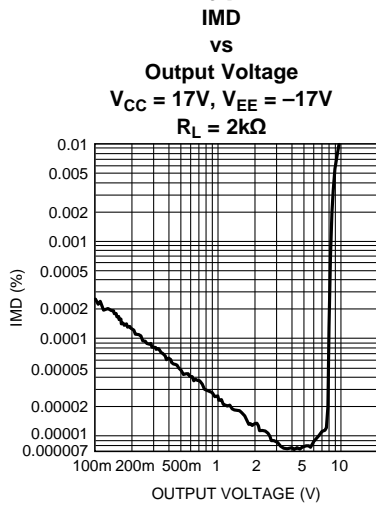

Typical Performance Characteristics (continued)

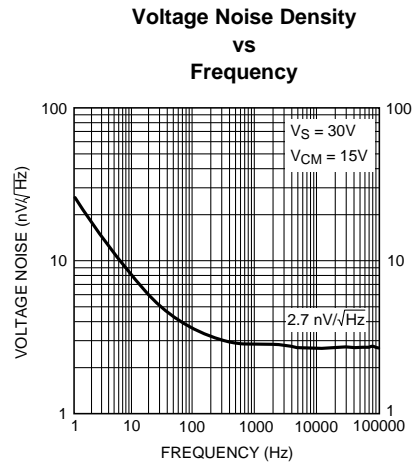
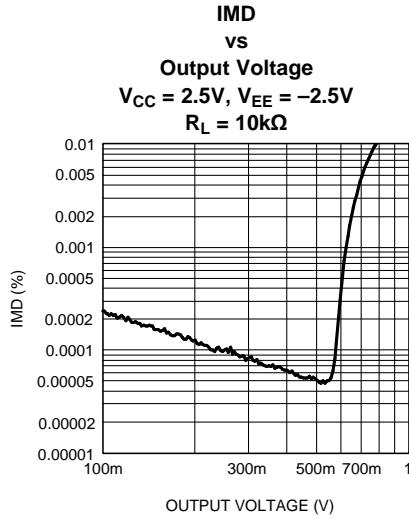
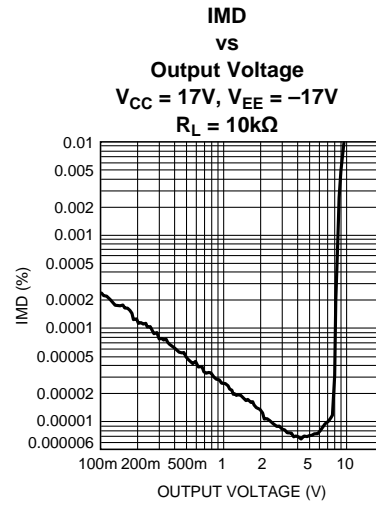
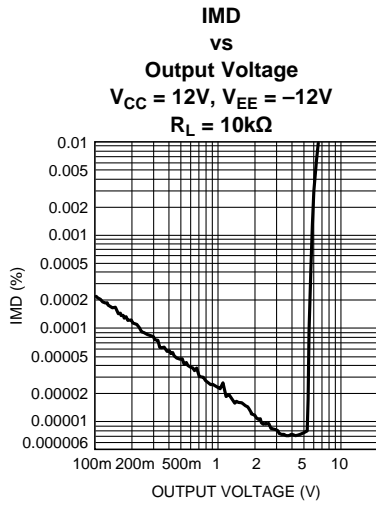

Typical Performance Characteristics (continued)

Current Noise Density vs Frequency

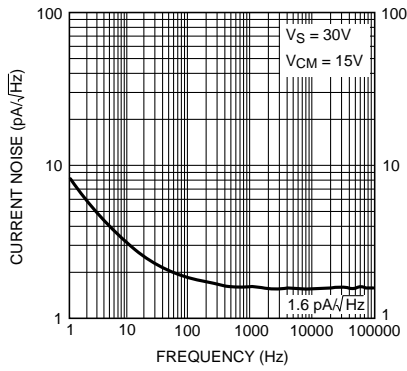

Crosstalk vs Frequency
 $V_{CC} = 15V, V_{EE} = -15V, V_{OUT} = 3V_{RMS}$
 $A_V = 0dB, R_L = 2k\Omega$

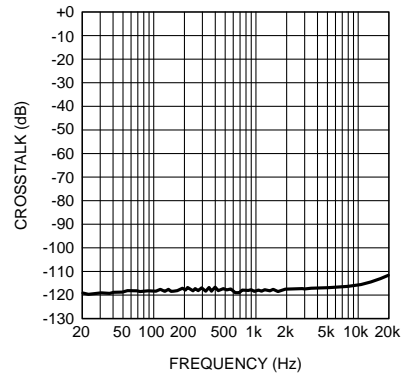

Crosstalk vs Frequency
 $V_{CC} = 15V, V_{EE} = -15V, V_{OUT} = 10V_{RMS}$
 $A_V = 0dB, R_L = 2k\Omega$

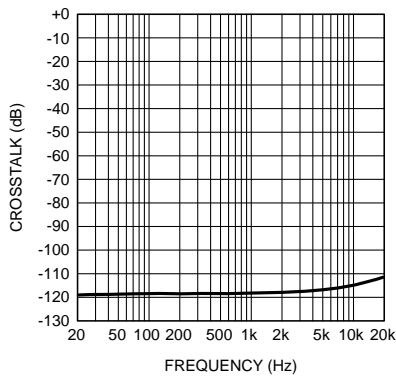

Crosstalk vs Frequency
 $V_{CC} = 12V, V_{EE} = -12V, V_{OUT} = 3V_{RMS}$
 $A_V = 0dB, R_L = 2k\Omega$

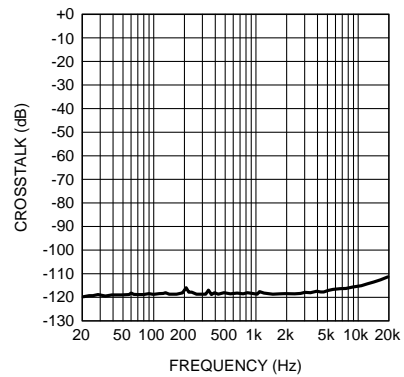

Typical Performance Characteristics (continued)

**Crosstalk
vs
Frequency**
 $V_{CC} = 12V, V_{EE} = -12V, V_{OUT} = 10V_{RMS}$
 $A_V = 0dB, R_L = 2k\Omega$

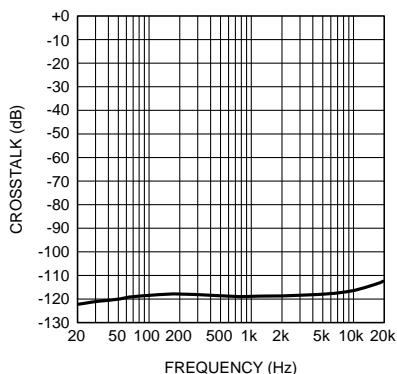

**Crosstalk
vs
Frequency**
 $V_{CC} = 17V, V_{EE} = -17V, V_{OUT} = 3V_{RMS}$
 $A_V = 0dB, R_L = 2k\Omega$

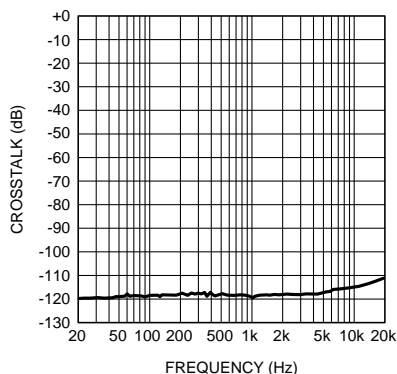

**Crosstalk
vs
Frequency**
 $V_{CC} = 17V, V_{EE} = -17V, V_{OUT} = 10V_{RMS}$
 $A_V = 0dB, R_L = 2k\Omega$

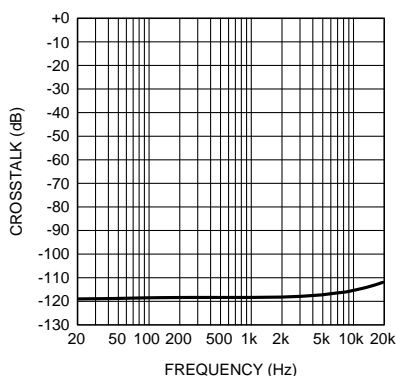

**Crosstalk
vs
Frequency**
 $V_{CC} = 2.5V, V_{EE} = -2.5V, V_{OUT} = 1V_{RMS}$
 $A_V = 0dB, R_L = 2k\Omega$

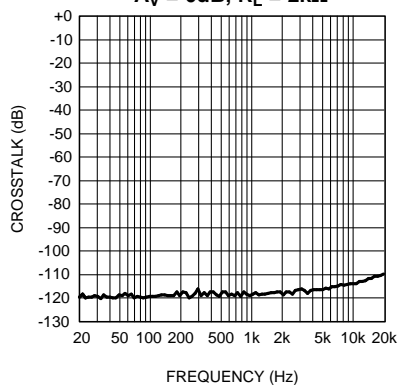

Typical Performance Characteristics (continued)

Crosstalk vs Frequency
 $V_{CC} = 15V, V_{EE} = -15V, V_{OUT} = 3V_{RMS}$
 $A_V = 0dB, R_L = 600\Omega$

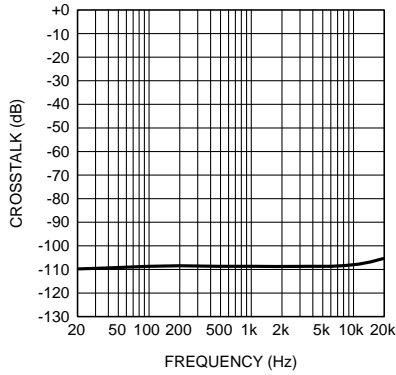

Crosstalk vs Frequency
 $V_{CC} = 15V, V_{EE} = -15V, V_{OUT} = 10V_{RMS}$
 $A_V = 0dB, R_L = 600\Omega$

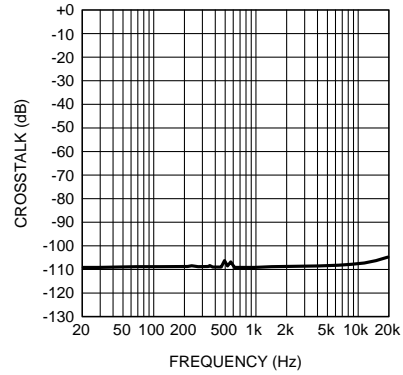

Crosstalk vs Frequency
 $V_{CC} = 12V, V_{EE} = -12V, V_{OUT} = 3V_{RMS}$
 $A_V = 0dB, R_L = 600\Omega$

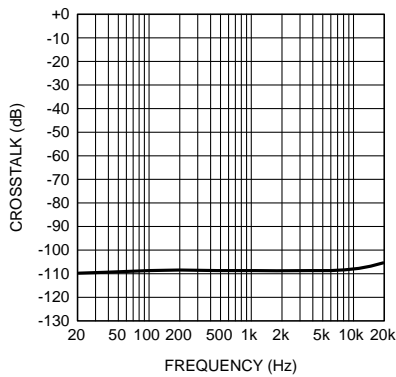

Crosstalk vs Frequency
 $V_{CC} = 12V, V_{EE} = -12V, V_{OUT} = 10V_{RMS}$
 $A_V = 0dB, R_L = 600\Omega$

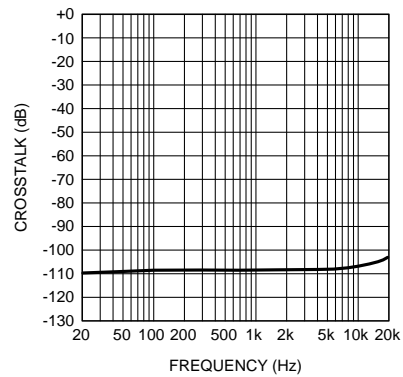

Typical Performance Characteristics (continued)

Crosstalk vs Frequency
 $V_{CC} = 17V, V_{EE} = -17V, V_{OUT} = 3V_{RMS}$
 $A_V = 0dB, R_L = 600\Omega$

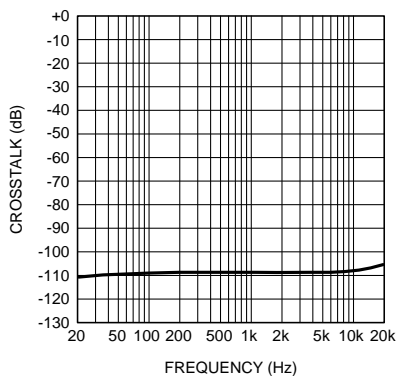

Crosstalk vs Frequency
 $V_{CC} = 17V, V_{EE} = -17V, V_{OUT} = 10V_{RMS}$
 $A_V = 0dB, R_L = 600\Omega$

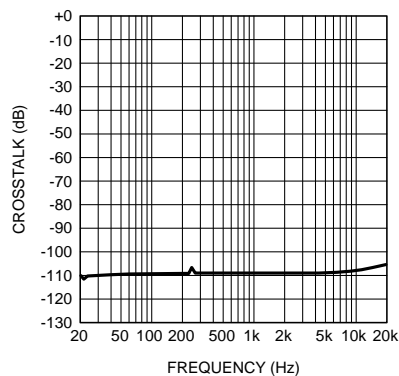

Crosstalk vs Frequency
 $V_{CC} = 2.5V, V_{EE} = -2.5V, V_{OUT} = 1V_{RMS}$
 $A_V = 0dB, R_L = 600\Omega$

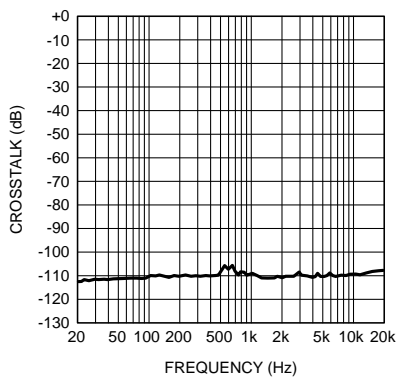

Crosstalk vs Frequency
 $V_{CC} = 15V, V_{EE} = -15V, V_{OUT} = 3V_{RMS}$
 $A_V = 0dB, R_L = 10k\Omega$

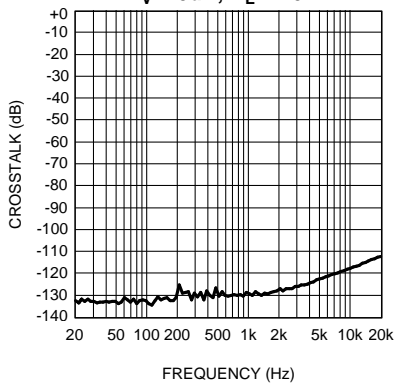

Typical Performance Characteristics (continued)

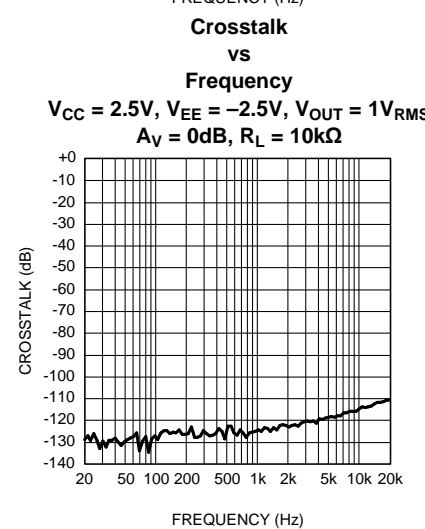
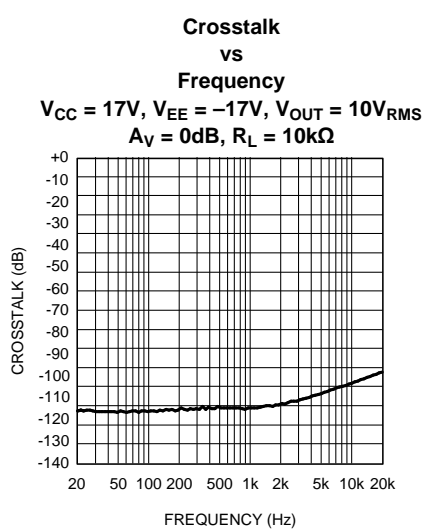
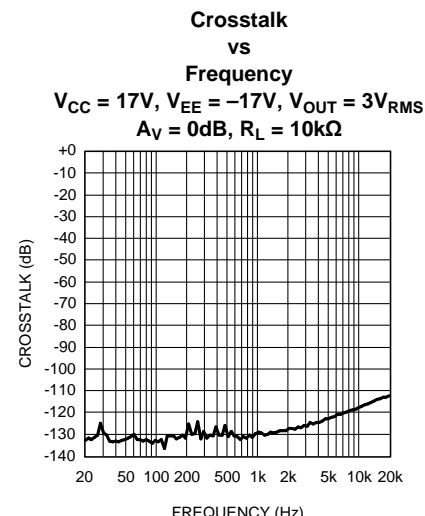
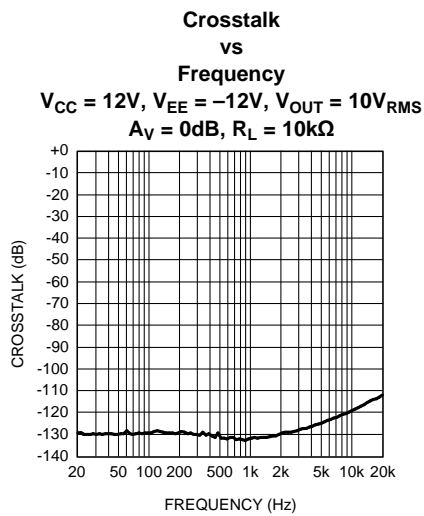
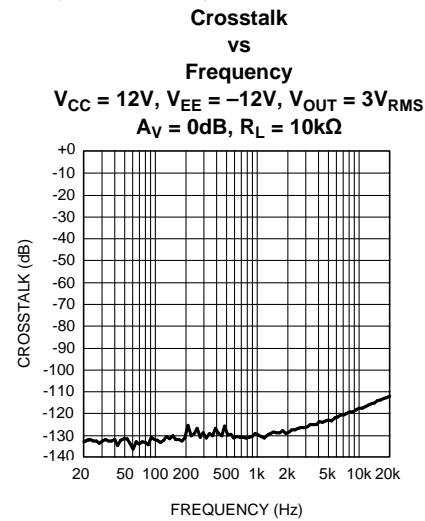
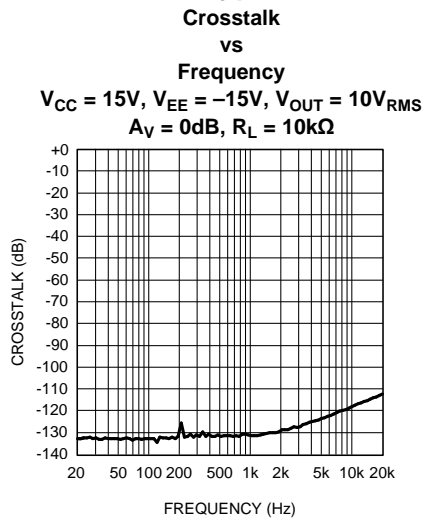

Typical Performance Characteristics (continued)

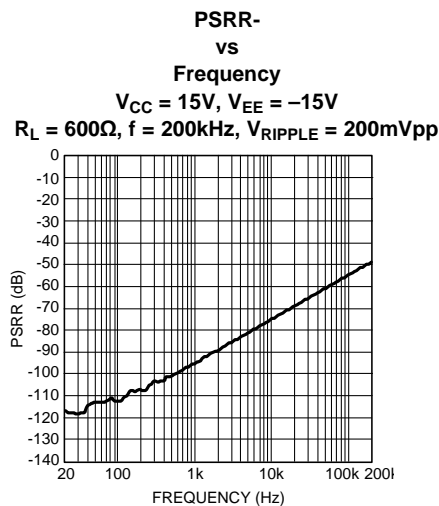
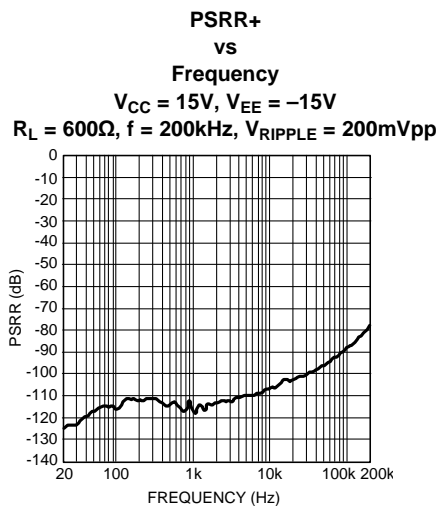
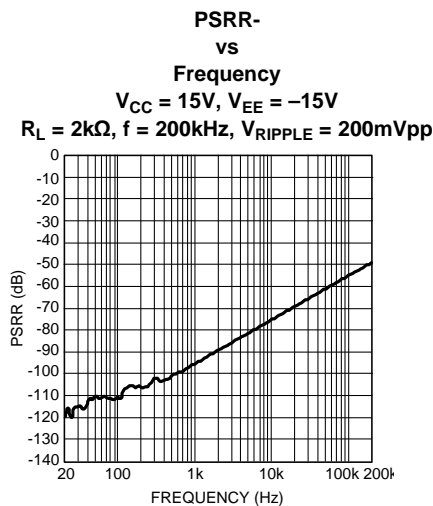
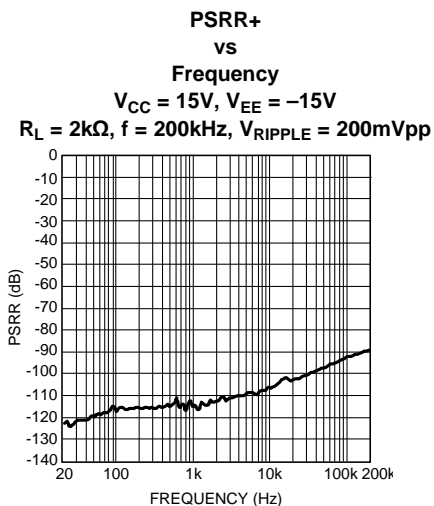
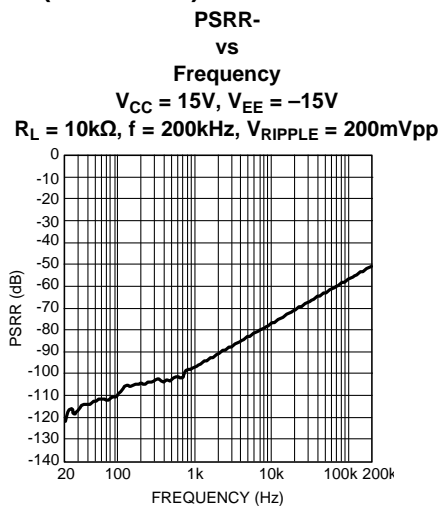
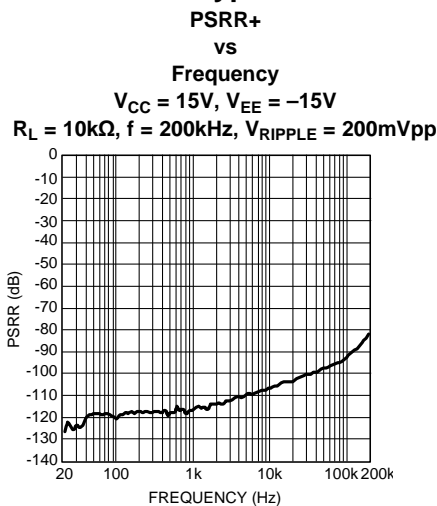

Typical Performance Characteristics (continued)

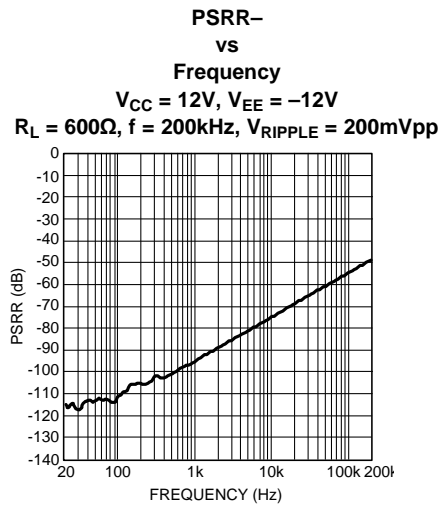
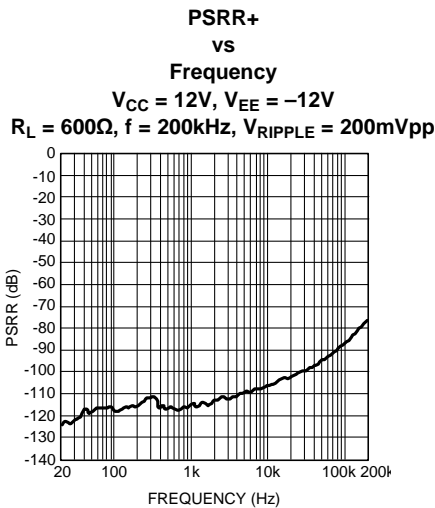
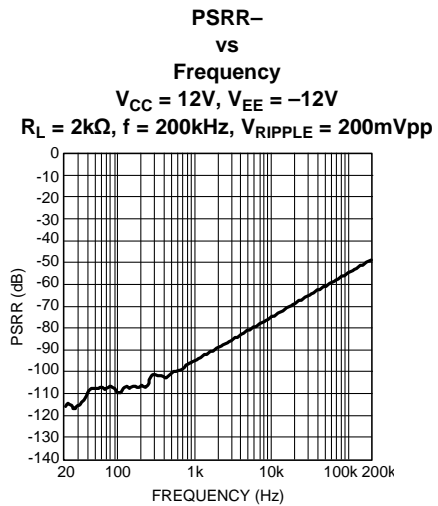
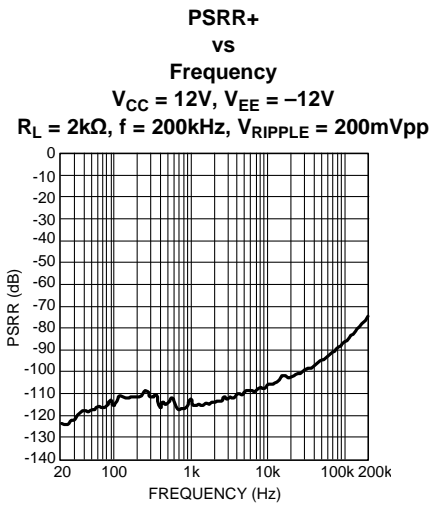
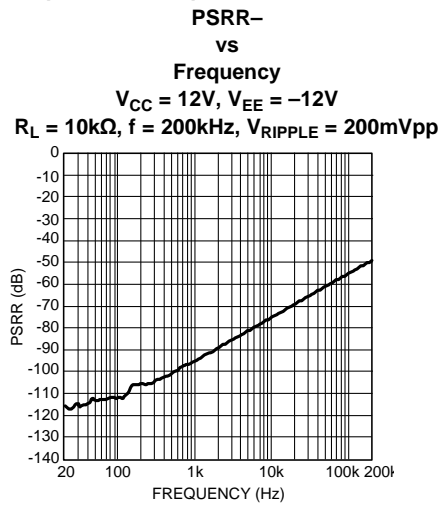
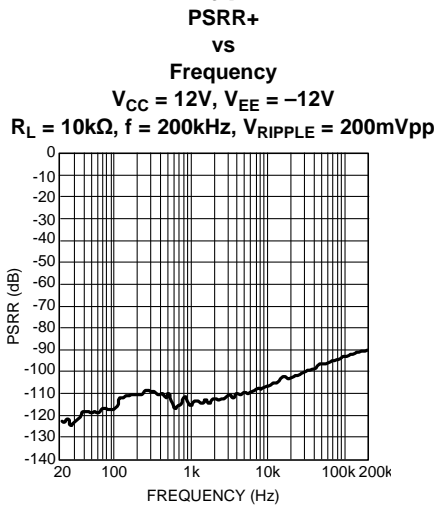

Typical Performance Characteristics (continued)

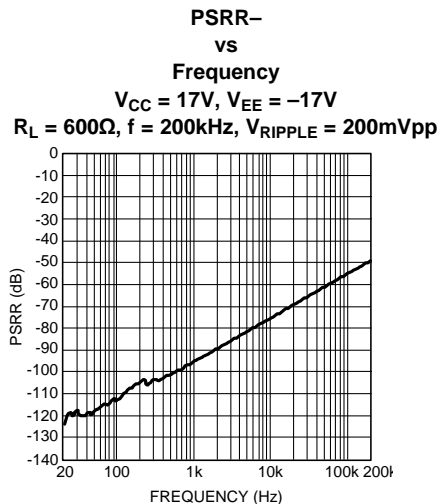
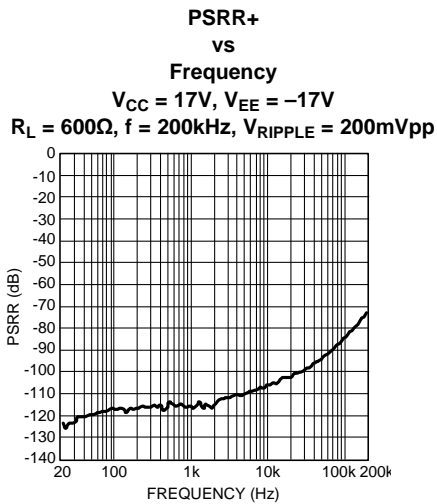
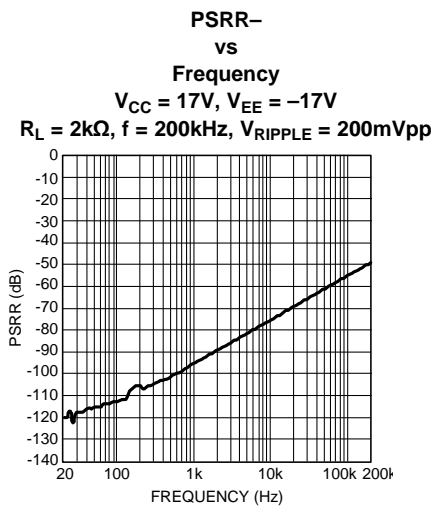
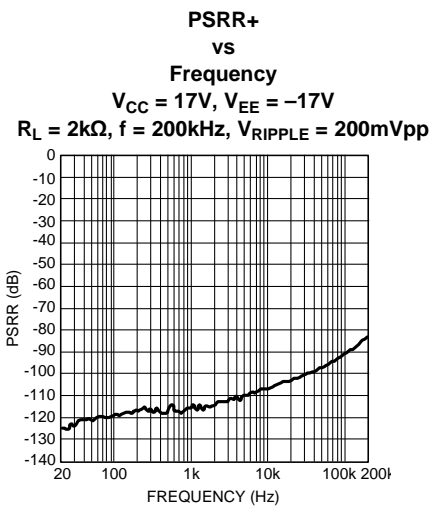
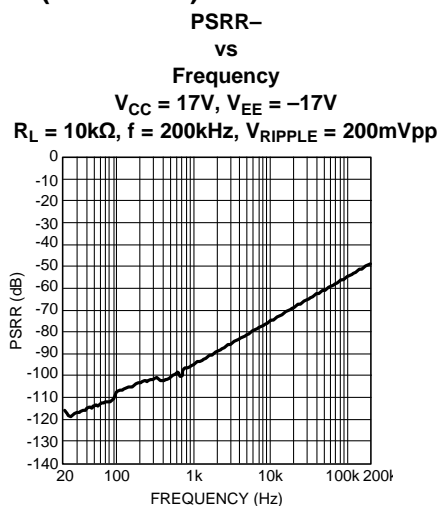
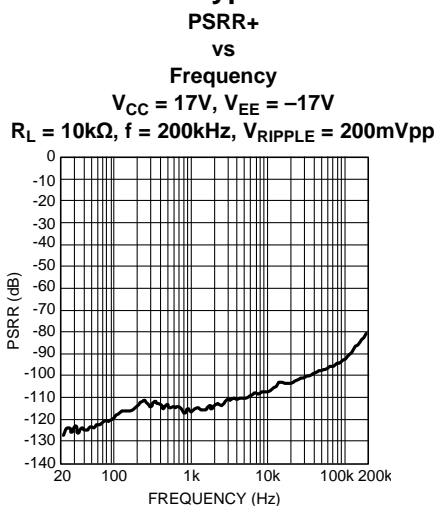

Typical Performance Characteristics (continued)

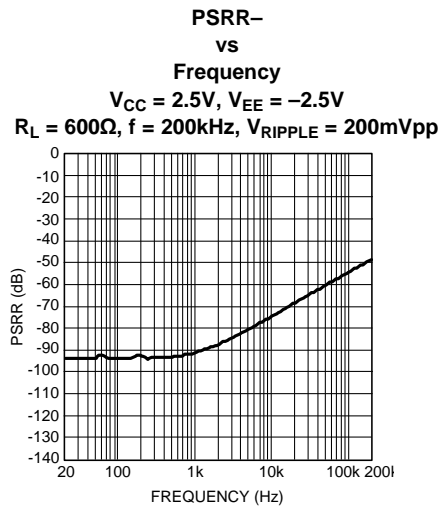
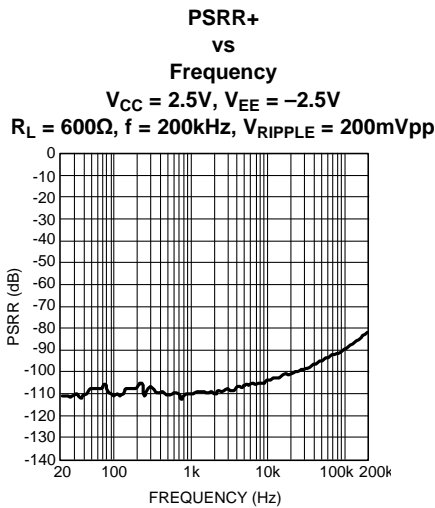
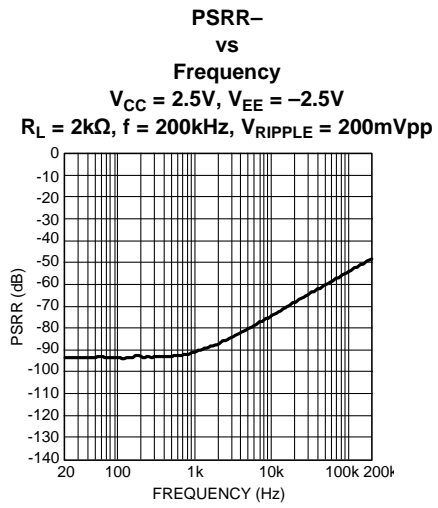
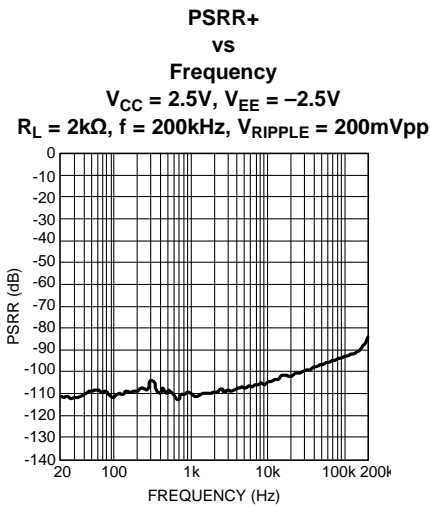
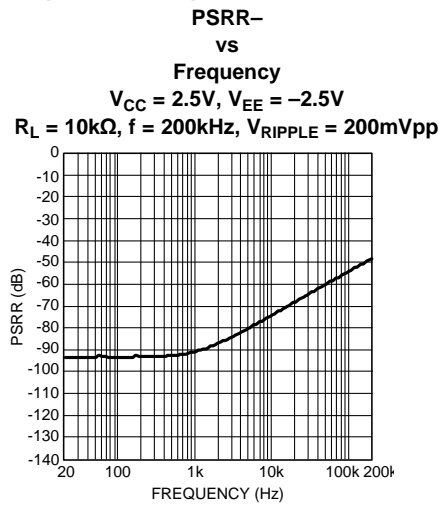
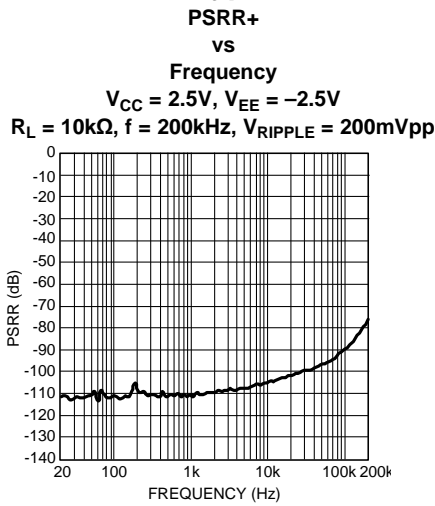

Typical Performance Characteristics (continued)

CMRR
vs
Frequency
 $V_{CC} = 15V, V_{EE} = -15V$
 $R_L = 2k\Omega$

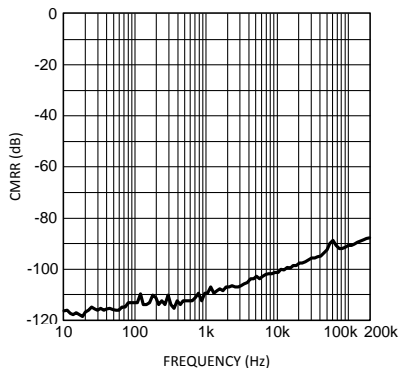

CMRR
vs
Frequency
 $V_{CC} = 12V, V_{EE} = -12V$
 $R_L = 2k\Omega$

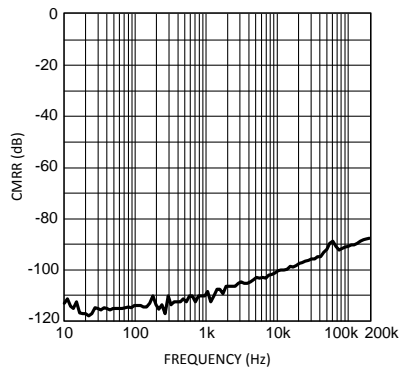

CMRR
vs
Frequency
 $V_{CC} = 17V, V_{EE} = -17V$
 $R_L = 2k\Omega$

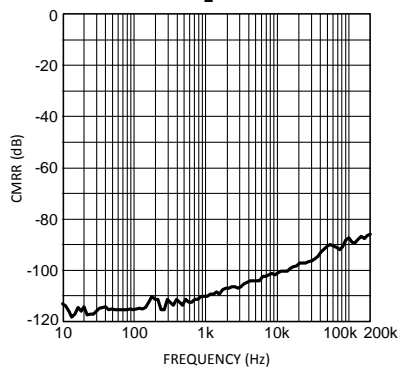

CMRR
vs
Frequency
 $V_{CC} = 2.5V, V_{EE} = -2.5V$
 $R_L = 2k\Omega$

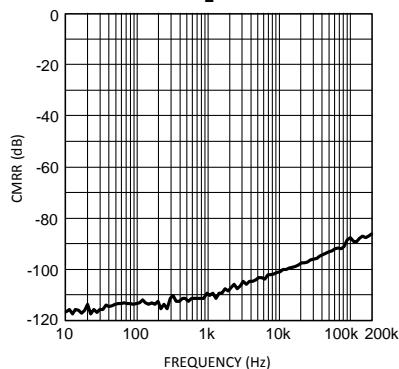

CMRR
vs
Frequency
 $V_{CC} = 15V, V_{EE} = -15V$
 $R_L = 600\Omega$

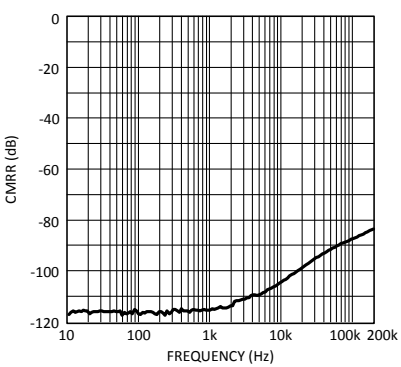

CMRR
vs
Frequency
 $V_{CC} = 12V, V_{EE} = -12V$
 $R_L = 600\Omega$

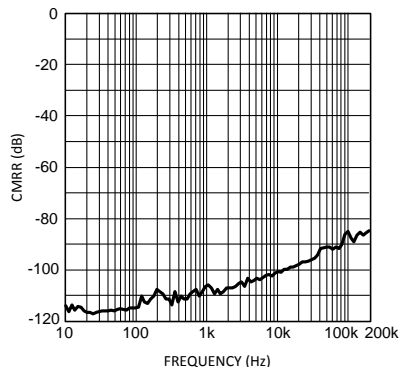

Typical Performance Characteristics (continued)

CMRR
vs
Frequency
 $V_{CC} = 17V, V_{EE} = -17V$
 $R_L = 600\Omega$

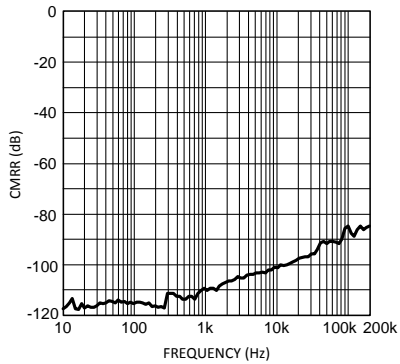

CMRR
vs
Frequency
 $V_{CC} = 2.5V, V_{EE} = -2.5V$
 $R_L = 600\Omega$

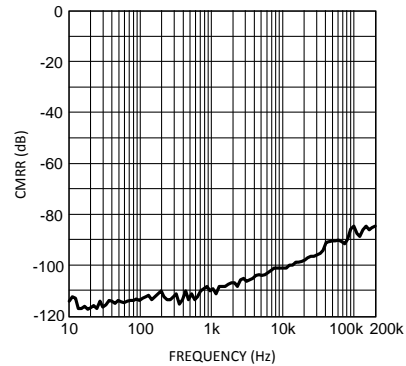

CMRR
vs
Frequency
 $V_{CC} = 15V, V_{EE} = -15V$
 $R_L = 10k\Omega$

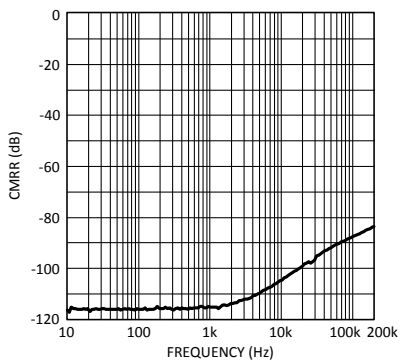

CMRR
vs
Frequency
 $V_{CC} = 12V, V_{EE} = -12V$
 $R_L = 10k\Omega$

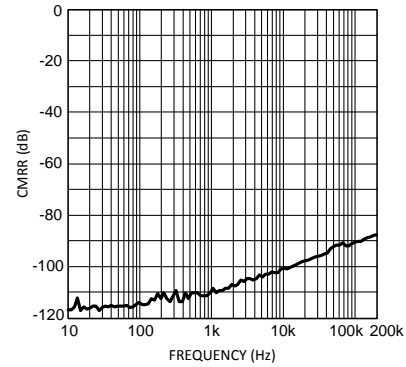

CMRR
vs
Frequency
 $V_{CC} = 17V, V_{EE} = -17V$
 $R_L = 10k\Omega$

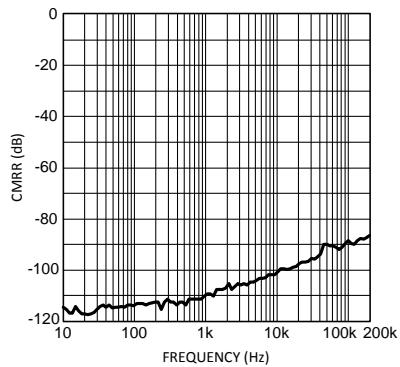

CMRR
vs
Frequency
 $V_{CC} = 2.5V, V_{EE} = -2.5V$
 $R_L = 10k\Omega$

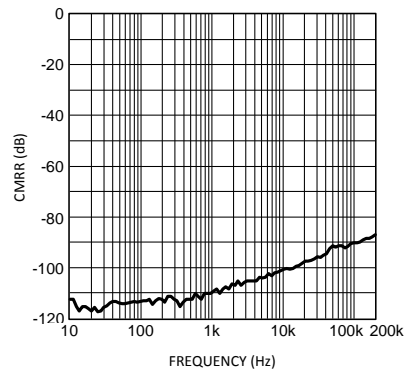

Typical Performance Characteristics (continued)

Output Voltage vs Load Resistance
 $V_{DD} = 15V, V_{EE} = -15V$
 THD+N = 1%

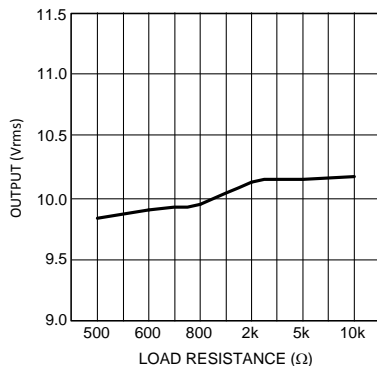

Output Voltage vs Load Resistance
 $V_{DD} = 12V, V_{EE} = -12V$
 THD+N = 1%

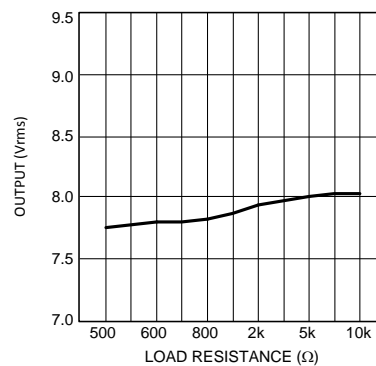

Output Voltage vs Load Resistance
 $V_{DD} = 17V, V_{EE} = -17V$
 THD+N = 1%

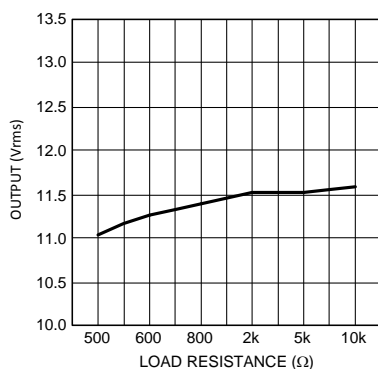

Output Voltage vs Load Resistance
 $V_{DD} = 2.5V, V_{EE} = -2.5V$
 THD+N = 1%

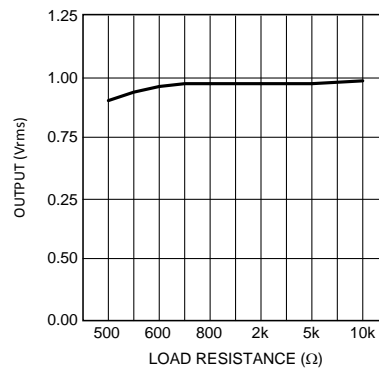

Output Voltage vs Supply Voltage
 $R_L = 2k\Omega, THD+N = 1\%$

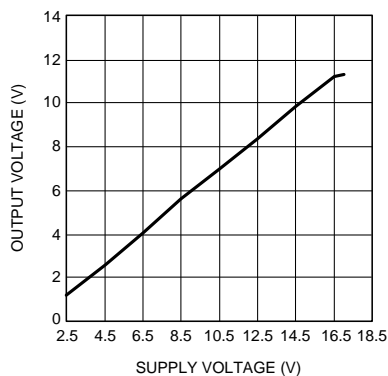

Output Voltage vs Supply Voltage
 $R_L = 600\Omega, THD+N = 1\%$

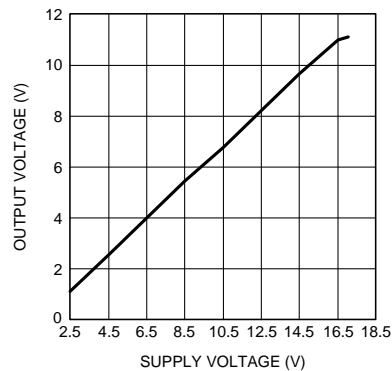

Typical Performance Characteristics (continued)

**Output Voltage
vs
Supply Voltage**
 $R_L = 10k\Omega$, THD+N = 1%

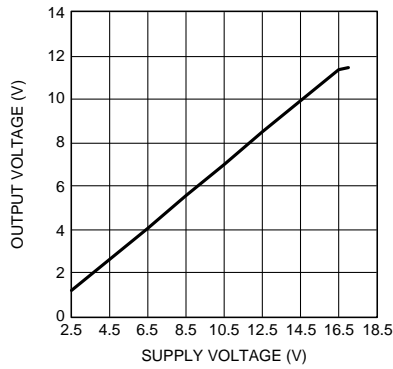

**Supply Current
vs
Supply Voltage**
 $R_L = 2k\Omega$

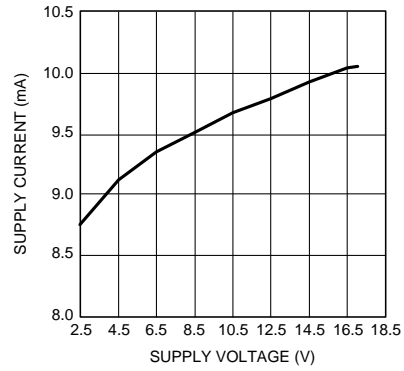

**Supply Current
vs
Supply Voltage**
 $R_L = 600\Omega$

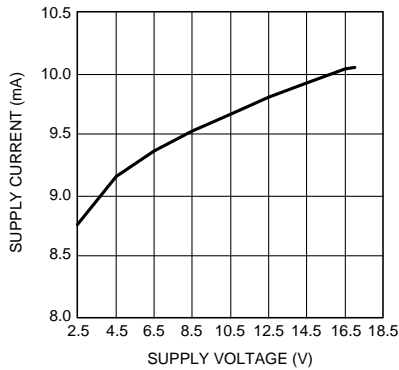

**Supply Current
vs
Supply Voltage**
 $R_L = 10k\Omega$

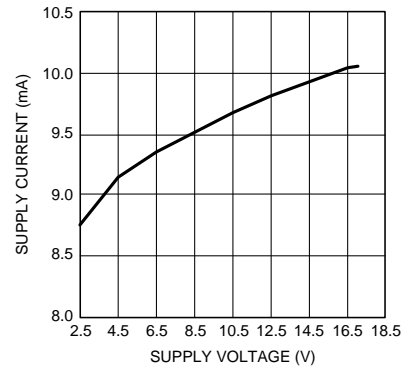

**Full Power Bandwidth
vs
Frequency**

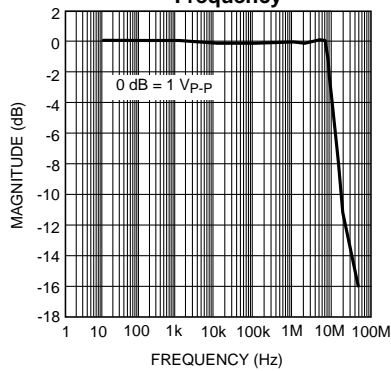

**Gain Phase
vs
Frequency**

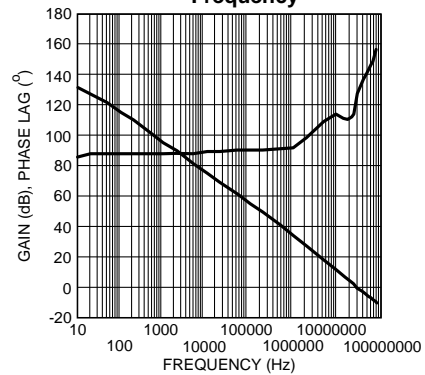

Typical Performance Characteristics (continued)

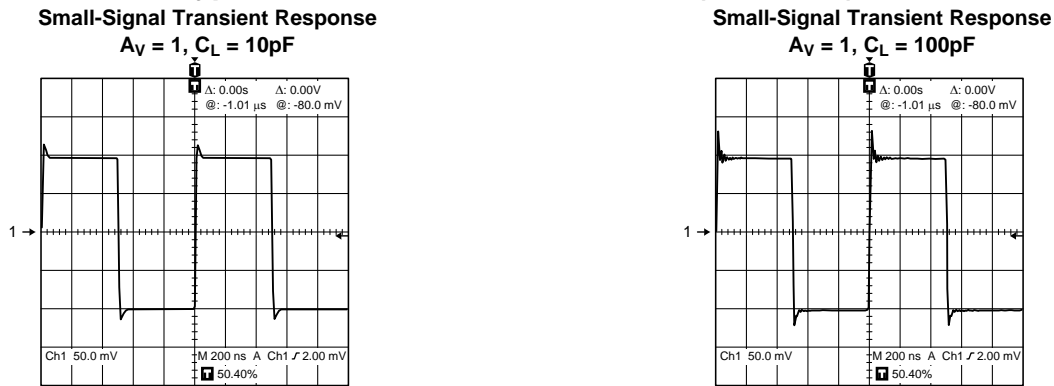

Application Information

DISTORTION MEASUREMENTS

The vanishingly low residual distortion produced by LME49720 is below the capabilities of all commercially available equipment. This makes distortion measurements just slightly more difficult than simply connecting a distortion meter to the amplifier’s inputs and outputs. The solution, however, is quite simple: an additional resistor. Adding this resistor extends the resolution of the distortion measurement equipment.

The LME49720’s low residual distortion is an input referred internal error. As shown in Figure 1, adding the 10Ω resistor connected between the amplifier’s inverting and non-inverting inputs changes the amplifier’s noise gain. The result is that the error signal (distortion) is amplified by a factor of 101. Although the amplifier’s closed-loop gain is unaltered, the feedback available to correct distortion errors is reduced by 101, which means that measurement resolution increases by 101. To ensure minimum effects on distortion measurements, keep the value of R1 low as shown in Figure 1.

This technique is verified by duplicating the measurements with high closed loop gain and/or making the measurements at high frequencies. Doing so produces distortion components that are within the measurement equipment’s capabilities. This datasheet’s THD+N and IMD values were generated using the above described circuit connected to an Audio Precision System Two Cascade.

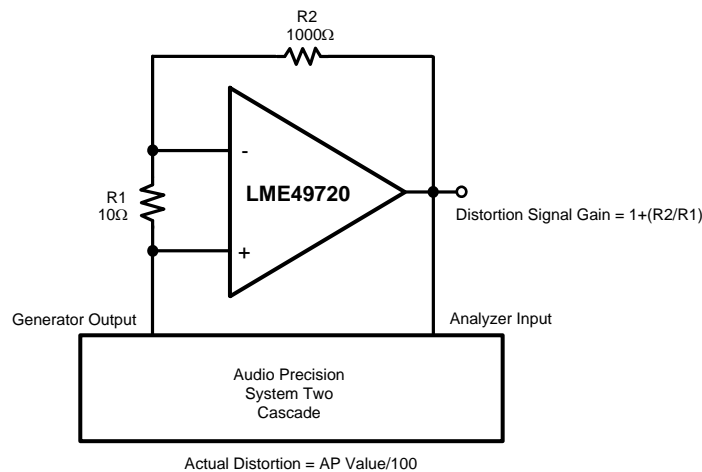
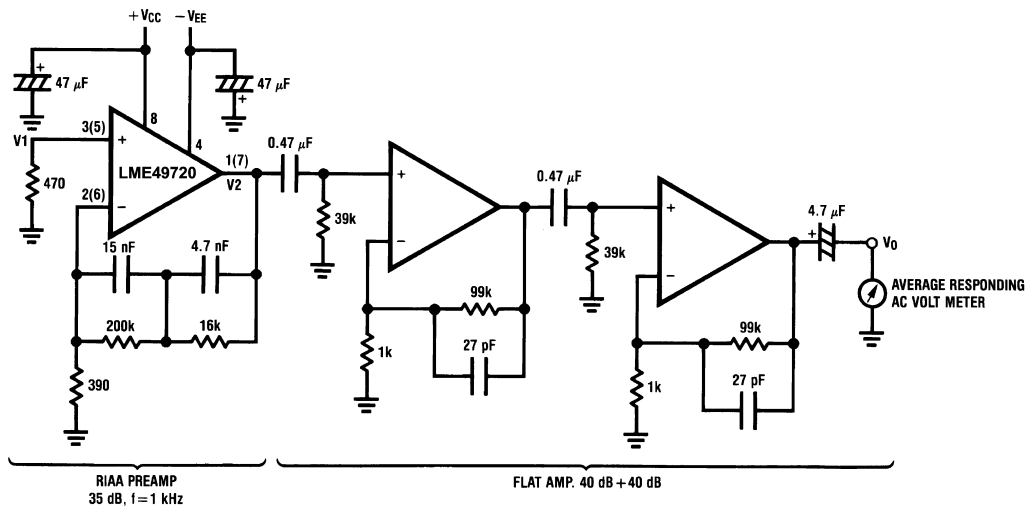

Figure 4. THD+N and IMD Distortion Test Circuit

The LME49720 is a high speed op amp with excellent phase margin and stability. Capacitive loads up to 100pF will cause little change in the phase characteristics of the amplifiers and are therefore allowable.

Capacitive loads greater than 100pF must be isolated from the output. The most straightforward way to do this is to put a resistor in series with the output. This resistor will also prevent excess power dissipation if the output is accidentally shorted.



Complete shielding is required to prevent induced pick up from external sources. Always check with oscilloscope for power line noise.

Figure 5. Noise Measurement Circuit
Total Gain: 115 dB @ $f = 1$ kHz
Input Referred Noise Voltage: $e_n = V_0/560,000$ (V)

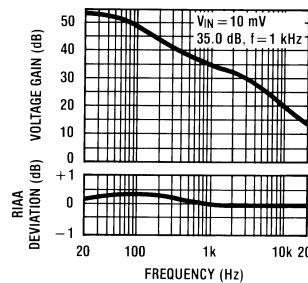

Figure 6. RIAA Preamp Voltage Gain, RIAA Deviation vs Frequency

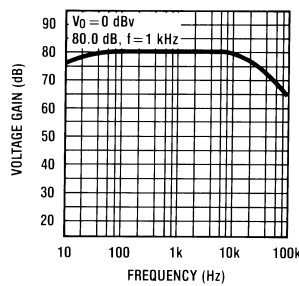
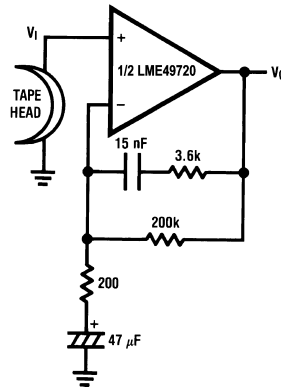

Figure 7. Flat Amp Voltage Gain vs Frequency

TYPICAL APPLICATIONS



$A_V = 34.5$
 $F = 1 \text{ kHz}$
 $E_n = 0.38 \mu\text{V}$
 A Weighted

Figure 8. NAB Preamp

Figure 9.

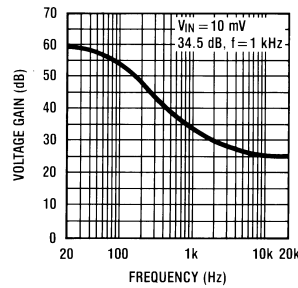
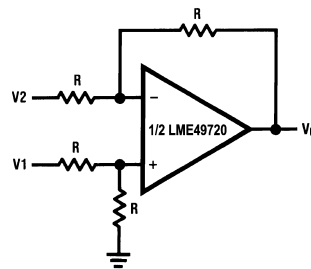
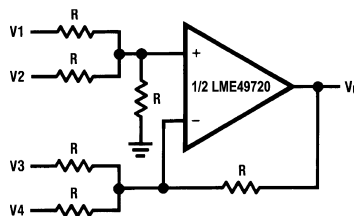

Figure 10. NAB Preamp Voltage Gain vs Frequency



$V_O = V_1 - V_2$

Figure 11. Balanced to Single Ended Converter



$V_O = V_1 + V_2 - V_3 - V_4$

Figure 12. Adder/Subtractor

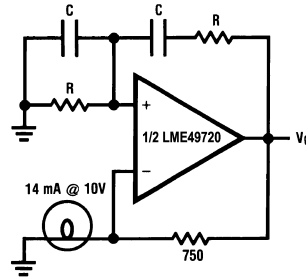

$$f_0 = \frac{1}{2\pi RC}$$

Figure 13. Sine Wave Oscillator

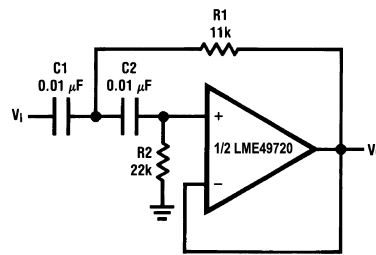

if $C_1 = C_2 = C$

$$R_1 = \frac{\sqrt{2}}{2\omega_0 C}$$

$$R_2 = 2 \cdot R_1$$

Illustration is $f_0 = 1 \text{ kHz}$

Figure 14. Second Order High Pass Filter (Butterworth)

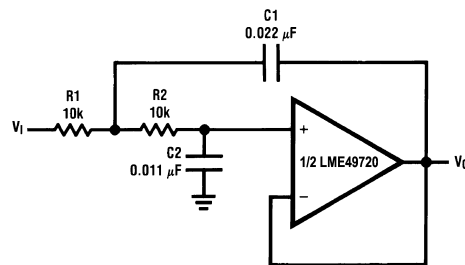

if $R_1 = R_2 = R$

$$C_1 = \frac{\sqrt{2}}{\omega_0 R}$$

$$C_2 = \frac{C_1}{2}$$

Illustration is $f_0 = 1 \text{ kHz}$

Figure 15. Second Order Low Pass Filter (Butterworth)

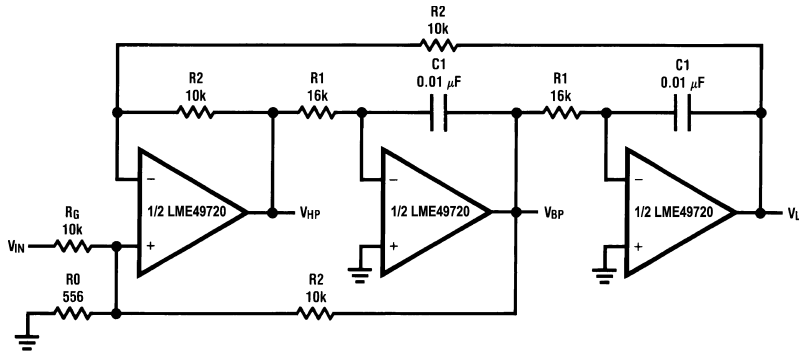

$$f_0 = \frac{1}{2\pi C_1 R_1}, Q = \frac{1}{2} \left(1 + \frac{R_2}{R_0} + \frac{R_2}{R_G} \right), A_{BP} = Q A_{LP} = Q A_{LH} = \frac{R_2}{R_G}$$

Illustration is $f_0 = 1 \text{ kHz}$, $Q = 10$, $A_{BP} = 1$

Figure 16. State Variable Filter

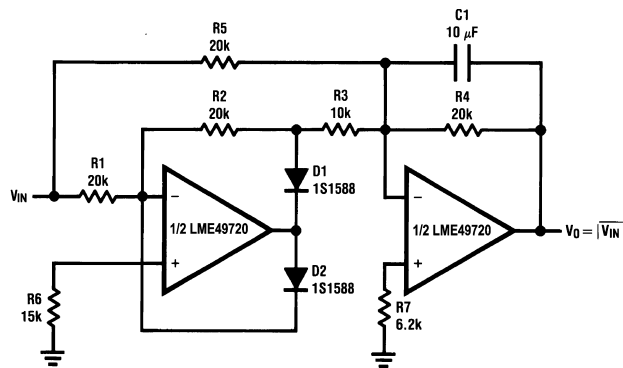

Figure 17. AC/DC Converter

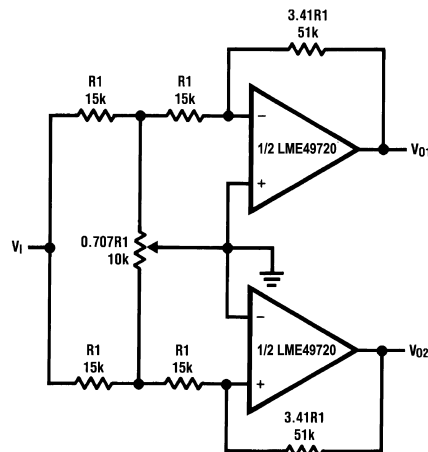

Figure 18. 2 Channel Panning Circuit (Pan Pot)

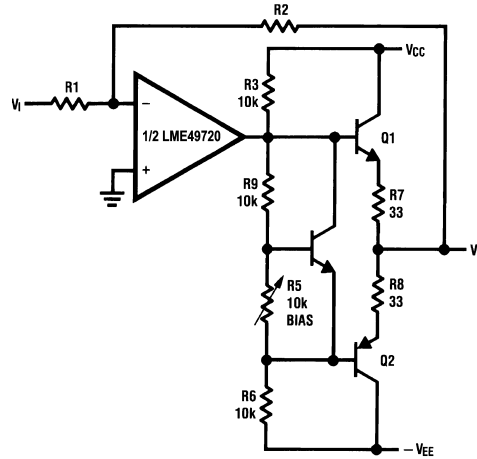
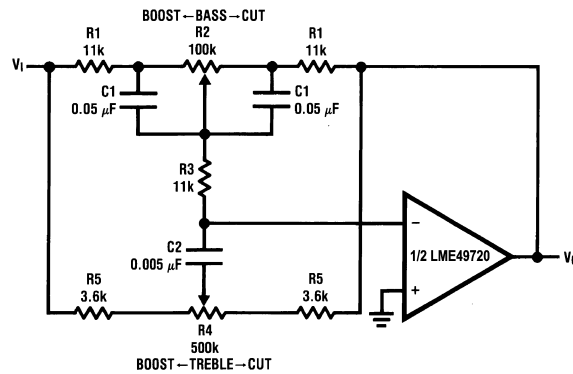

Figure 19. Line Driver



$$f_L = \frac{1}{2\pi R_2 C_1}, f_{LB} = \frac{1}{2\pi R_1 C_1}$$

$$f_H = \frac{1}{2\pi R_5 C_2}, f_{HB} = \frac{1}{2\pi (R_1 + R_5 + 2R_3) C_2}$$

Illustration is:

$$f_L = 32 \text{ Hz}, f_{LB} = 320 \text{ Hz}$$

$$f_H = 11 \text{ kHz}, f_{HB} = 1.1 \text{ kHz}$$

Figure 20. Tone Control

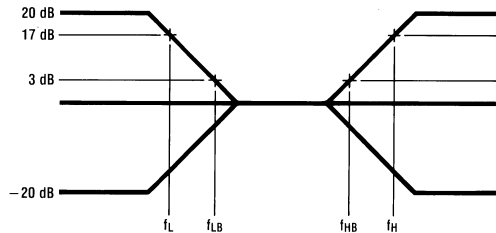
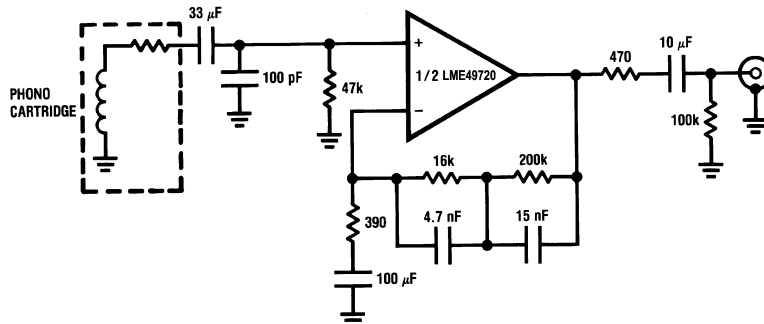
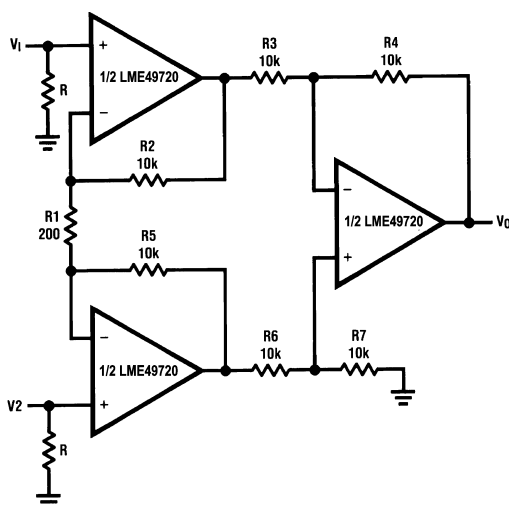

Figure 21. RIAA Preamp



$A_v = 35 \text{ dB}$
 $E_n = 0.33 \mu\text{V}$
 $S/N = 90 \text{ dB}$
 $f = 1 \text{ kHz}$
 A Weighted
 A Weighted, $V_{IN} = 10 \text{ mV}$
 @ $f = 1 \text{ kHz}$

Figure 22. Balanced Input Mic Amp



If $R2 = R5$, $R3 = R6$, $R4 = R7$

$$V_0 = \left(1 + \frac{2R_2}{R_1}\right) \frac{R_4}{R_3} (V_2 - V_1)$$

Illustration is:

$$V_0 = 101(V_2 - V_1)$$

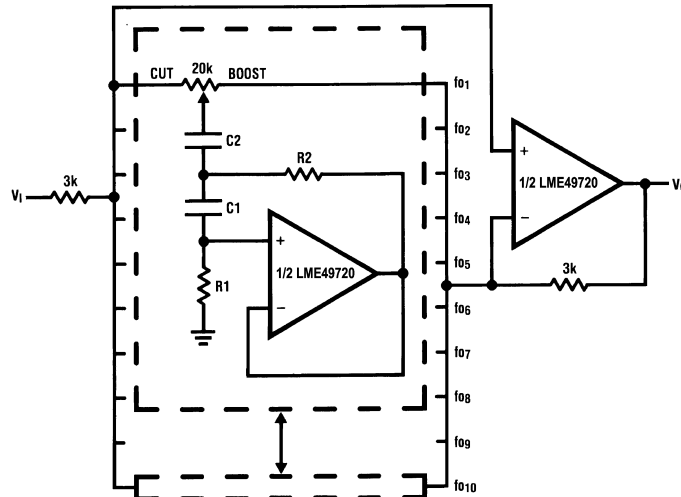

Figure 23. 10 Band Graphic Equalizer

fo (Hz)	C ₁	C ₂	R ₁	R ₂
32	0.12μF	4.7μF	75kΩ	500Ω
64	0.056μF	3.3μF	68kΩ	510Ω
125	0.033μF	1.5μF	62kΩ	510Ω
250	0.015μF	0.82μF	68kΩ	470Ω
500	8200pF	0.39μF	62kΩ	470Ω
1k	3900pF	0.22μF	68kΩ	470Ω
2k	2000pF	0.1μF	68kΩ	470Ω
4k	1100pF	0.056μF	62kΩ	470Ω
8k	510pF	0.022μF	68kΩ	510Ω
16k	330pF	0.012μF	51kΩ	510Ω

Revision History

Rev	Date	Description
1.0	03/30/07	Initial release.
1.1	05/03/07	Put the "general note" under the EC table.
1.2	10/22/07	Replaced all the PSRR curves.

PACKAGING INFORMATION

Orderable Device	Status (1)	Package Type	Package Drawing	Pins	Package Qty	Eco Plan (2)	Lead/Ball Finish	MSL Peak Temp (3)	Samples (Requires Login)
LME49720HA/NOPB	ACTIVE	TO-99	LMC	8	20	Green (RoHS & no Sb/Br)	POST-PLATE	Level-1-NA-UNLIM	
LME49720MA/NOPB	ACTIVE	SOIC	D	8	95	Green (RoHS & no Sb/Br)	CU SN	Level-1-260C-UNLIM	
LME49720MAX/NOPB	ACTIVE	SOIC	D	8	2500	Green (RoHS & no Sb/Br)	CU SN	Level-1-260C-UNLIM	
LME49720NA/NOPB	ACTIVE	PDIP	P	8	40	Green (RoHS & no Sb/Br)	Call TI	Level-1-NA-UNLIM	

(1) The marketing status values are defined as follows:

ACTIVE: Product device recommended for new designs.

LIFEBUY: TI has announced that the device will be discontinued, and a lifetime-buy period is in effect.

NRND: Not recommended for new designs. Device is in production to support existing customers, but TI does not recommend using this part in a new design.

PREVIEW: Device has been announced but is not in production. Samples may or may not be available.

OBSELETE: TI has discontinued the production of the device.

(2) Eco Plan - The planned eco-friendly classification: Pb-Free (RoHS), Pb-Free (RoHS Exempt), or Green (RoHS & no Sb/Br) - please check <http://www.ti.com/productcontent> for the latest availability information and additional product content details.

TBD: The Pb-Free/Green conversion plan has not been defined.

Pb-Free (RoHS): TI's terms "Lead-Free" or "Pb-Free" mean semiconductor products that are compatible with the current RoHS requirements for all 6 substances, including the requirement that lead not exceed 0.1% by weight in homogeneous materials. Where designed to be soldered at high temperatures, TI Pb-Free products are suitable for use in specified lead-free processes.

Pb-Free (RoHS Exempt): This component has a RoHS exemption for either 1) lead-based flip-chip solder bumps used between the die and package, or 2) lead-based die adhesive used between the die and leadframe. The component is otherwise considered Pb-Free (RoHS compatible) as defined above.

Green (RoHS & no Sb/Br): TI defines "Green" to mean Pb-Free (RoHS compatible), and free of Bromine (Br) and Antimony (Sb) based flame retardants (Br or Sb do not exceed 0.1% by weight in homogeneous material)

(3) MSL, Peak Temp. -- The Moisture Sensitivity Level rating according to the JEDEC industry standard classifications, and peak solder temperature.

Important Information and Disclaimer: The information provided on this page represents TI's knowledge and belief as of the date that it is provided. TI bases its knowledge and belief on information provided by third parties, and makes no representation or warranty as to the accuracy of such information. Efforts are underway to better integrate information from third parties. TI has taken and continues to take reasonable steps to provide representative and accurate information but may not have conducted destructive testing or chemical analysis on incoming materials and chemicals. TI and TI suppliers consider certain information to be proprietary, and thus CAS numbers and other limited information may not be available for release.

In no event shall TI's liability arising out of such information exceed the total purchase price of the TI part(s) at issue in this document sold by TI to Customer on an annual basis.

TAPE AND REEL INFORMATION



QUADRANT ASSIGNMENTS FOR PIN 1 ORIENTATION IN TAPE



*All dimensions are nominal

Device	Package Type	Package Drawing	Pins	SPQ	Reel Diameter (mm)	Reel Width W1 (mm)	A0 (mm)	B0 (mm)	K0 (mm)	P1 (mm)	W (mm)	Pin1 Quadrant
LME49720MAX/NOPB	SOIC	D	8	2500	330.0	12.4	6.5	5.4	2.0	8.0	12.0	Q1

TAPE AND REEL BOX DIMENSIONS



*All dimensions are nominal

Device	Package Type	Package Drawing	Pins	SPQ	Length (mm)	Width (mm)	Height (mm)
LME49720MAX/NOPB	SOIC	D	8	2500	349.0	337.0	45.0

LMC (O-MBCY-W8)

METAL CYLINDRICAL PACKAGE



- NOTES:
- A. All linear dimensions are in inches (millimeters).
 - B. This drawing is subject to change without notice.
 - C. Leads in true position within 0.010 (0,25) R @ MMC at seating plane.
 - D. Pin numbers shown for reference only. Numbers may not be marked on package.
 - E. Falls within JEDEC MO-002/TO-99.

P (R-PDIP-T8)

PLASTIC DUAL-IN-LINE PACKAGE



- NOTES:
- A. All linear dimensions are in inches (millimeters).
 - B. This drawing is subject to change without notice.
 - C. Falls within JEDEC MS-001 variation BA.

D (R-PDSO-G8)

PLASTIC SMALL OUTLINE



- NOTES:
- A. All linear dimensions are in inches (millimeters).
 - B. This drawing is subject to change without notice.
 - C. Body length does not include mold flash, protrusions, or gate burrs. Mold flash, protrusions, or gate burrs shall not exceed 0.006 (0,15) each side.
 - D. Body width does not include interlead flash. Interlead flash shall not exceed 0.017 (0,43) each side.
 - E. Reference JEDEC MS-012 variation AA.

IMPORTANT NOTICE

Texas Instruments Incorporated and its subsidiaries (TI) reserve the right to make corrections, enhancements, improvements and other changes to its semiconductor products and services per JESD46, latest issue, and to discontinue any product or service per JESD48, latest issue. Buyers should obtain the latest relevant information before placing orders and should verify that such information is current and complete. All semiconductor products (also referred to herein as "components") are sold subject to TI's terms and conditions of sale supplied at the time of order acknowledgment.

TI warrants performance of its components to the specifications applicable at the time of sale, in accordance with the warranty in TI's terms and conditions of sale of semiconductor products. Testing and other quality control techniques are used to the extent TI deems necessary to support this warranty. Except where mandated by applicable law, testing of all parameters of each component is not necessarily performed.

TI assumes no liability for applications assistance or the design of Buyers' products. Buyers are responsible for their products and applications using TI components. To minimize the risks associated with Buyers' products and applications, Buyers should provide adequate design and operating safeguards.

TI does not warrant or represent that any license, either express or implied, is granted under any patent right, copyright, mask work right, or other intellectual property right relating to any combination, machine, or process in which TI components or services are used. Information published by TI regarding third-party products or services does not constitute a license to use such products or services or a warranty or endorsement thereof. Use of such information may require a license from a third party under the patents or other intellectual property of the third party, or a license from TI under the patents or other intellectual property of TI.

Reproduction of significant portions of TI information in TI data books or data sheets is permissible only if reproduction is without alteration and is accompanied by all associated warranties, conditions, limitations, and notices. TI is not responsible or liable for such altered documentation. Information of third parties may be subject to additional restrictions.

Resale of TI components or services with statements different from or beyond the parameters stated by TI for that component or service voids all express and any implied warranties for the associated TI component or service and is an unfair and deceptive business practice. TI is not responsible or liable for any such statements.

Buyer acknowledges and agrees that it is solely responsible for compliance with all legal, regulatory and safety-related requirements concerning its products, and any use of TI components in its applications, notwithstanding any applications-related information or support that may be provided by TI. Buyer represents and agrees that it has all the necessary expertise to create and implement safeguards which anticipate dangerous consequences of failures, monitor failures and their consequences, lessen the likelihood of failures that might cause harm and take appropriate remedial actions. Buyer will fully indemnify TI and its representatives against any damages arising out of the use of any TI components in safety-critical applications.

In some cases, TI components may be promoted specifically to facilitate safety-related applications. With such components, TI's goal is to help enable customers to design and create their own end-product solutions that meet applicable functional safety standards and requirements. Nonetheless, such components are subject to these terms.

No TI components are authorized for use in FDA Class III (or similar life-critical medical equipment) unless authorized officers of the parties have executed a special agreement specifically governing such use.

Only those TI components which TI has specifically designated as military grade or "enhanced plastic" are designed and intended for use in military/aerospace applications or environments. Buyer acknowledges and agrees that any military or aerospace use of TI components which have **not** been so designated is solely at the Buyer's risk, and that Buyer is solely responsible for compliance with all legal and regulatory requirements in connection with such use.

TI has specifically designated certain components as meeting ISO/TS16949 requirements, mainly for automotive use. In any case of use of non-designated products, TI will not be responsible for any failure to meet ISO/TS16949.

Products

Audio	www.ti.com/audio
Amplifiers	amplifier.ti.com
Data Converters	dataconverter.ti.com
DLP® Products	www.dlp.com
DSP	dsp.ti.com
Clocks and Timers	www.ti.com/clocks
Interface	interface.ti.com
Logic	logic.ti.com
Power Mgmt	power.ti.com
Microcontrollers	microcontroller.ti.com
RFID	www.ti-rfid.com
OMAP Applications Processors	www.ti.com/omap
Wireless Connectivity	www.ti.com/wirelessconnectivity

Applications

Automotive and Transportation	www.ti.com/automotive
Communications and Telecom	www.ti.com/communications
Computers and Peripherals	www.ti.com/computers
Consumer Electronics	www.ti.com/consumer-apps
Energy and Lighting	www.ti.com/energy
Industrial	www.ti.com/industrial
Medical	www.ti.com/medical
Security	www.ti.com/security
Space, Avionics and Defense	www.ti.com/space-avionics-defense
Video and Imaging	www.ti.com/video

TI E2E Community

e2e.ti.com

Mouser Electronics

Authorized Distributor

Click to View Pricing, Inventory, Delivery & Lifecycle Information:

[Texas Instruments:](#)

[LME49720HABD](#)