

### DESCRIPTION

The MP9517 is a single-phase, brushless DC motor driver with integrated power MOSFETs and a Hall-effect sensor. The IC has a 3.3V to 18V input voltage range and input line reverse voltage protection.

The MP9517 controls the rotational speed through the PWM signal on the PWM pin, with a 2kHz to 100kHz PWM frequency range. The MP9517 has a rotational speed detection feature on the FG pin, an open-drain output.

To reduce fan driver audible noise and power loss, the MP9517 features soft-on/off phase commutation, and automatic control for winding BEMF and current zero-crossing with the same phase.

Full protection features include input over-voltage protection (OVP), under-voltage lockout (UVLO), rotor deadlock protection, thermal shutdown, and input reverse protection.

The MP9517 requires a minimal number of external components to reduce solution cost. It is available in a TSOT23-6-SL and TSOT23-6-L package.

### FEATURES

- Embedded Hall Sensor with High Sensitivity
- Wide 3.3V to 18V Operating Input Range
- 2A Overload Current Limit
- Integrated Power MOSFETs: Total 1.02Ω (HS + LS)
- Winding BEMF and Current Zero-Crossing with the Same Phase
- Soft-On/Off Phase Commutation
- Rotational Speed Indicator (FG) Signal
- 2kHz to 100kHz PWM Input Frequency Range
- Fixed 26kHz Output Switching Frequency
- Input Line Reverse Voltage Protection (RVP)
- Rotor Deadlock Protection and Automatic Recovery
- Thermal Protection and Automatic Recovery
- Built-In Input OVP, UVLO, and Automatic Recovery
- Available in TSOT23-6-SL or TSOT23-6-L Packages

### APPLICATIONS

- CPU Fan for Personal Computers or Servers
- Brushless DC Motors

All MPS parts are lead-free, halogen-free, and adhere to the RoHS directive. For MPS green status, please visit the MPS website under Quality Assurance. "MPS", the MPS logo, and "Simple, Easy Solutions" are trademarks of Monolithic Power Systems, Inc. or its subsidiaries.

### TYPICAL APPLICATION

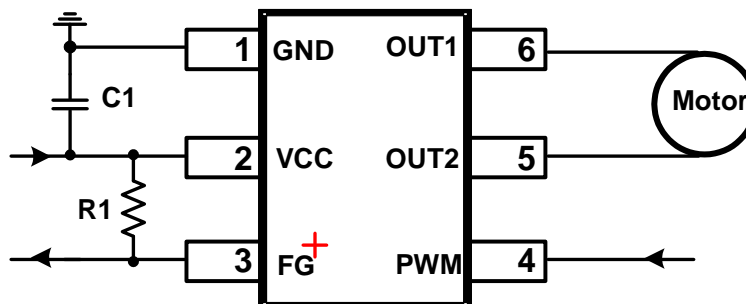

## ORDERING INFORMATION

Part Number*	Package	Top Marking	MSL Rating
MP9517GJS	TSOT23-6-SL	See Below	1
MP9517GJL	TSOT23-6-L		

\* For Tape & Reel, add suffix -Z (e.g. MP9517GJS-Z).

## TOP MARKING

**BMGY**  
**LLL**

BMGY: Product code of MP9517GJS  
Y: Year code  
LLL: Lot number

## TOP MARKING

**| BMGY**      **LLLL**

BMG: Product code of MP9517GJL  
Y: Year code  
LLLL: Lot number

### PACKAGE REFERENCE

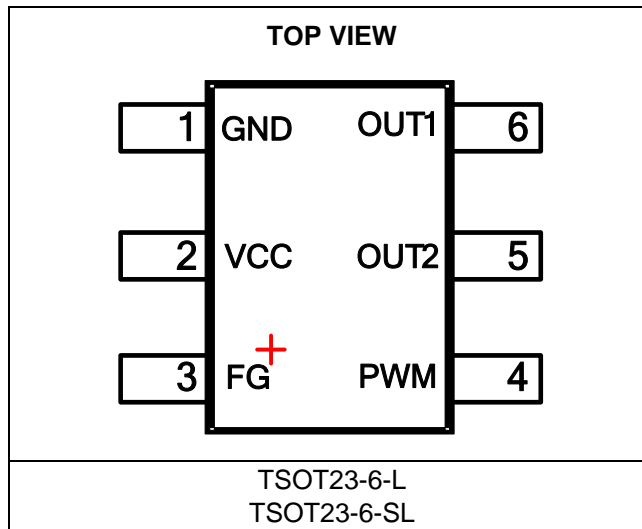

### PIN FUNCTIONS

Pin #	Name	Description
1	GND	<b>Ground.</b>
2	VCC	<b>Input voltage supply.</b>
3	FG	<b>Speed indication output.</b>
4	PWM	<b>Rotational speed control PWM input.</b> PWM is an internal pull-up to the internal LDO. It is recommended to keep the PWM frequency range between 2kHz and 100kHz.
5	OUT2	<b>Motor driver output 2.</b> OUT2 is connected to the midpoint of the internal N-channel MOSFET half-bridge.
6	OUT1	<b>Motor driver output 1.</b> OUT1 is connected to the midpoint of the internal N-channel MOSFET half-bridge.

**ABSOLUTE MAXIMUM RATINGS** <sup>(1)</sup>

$V_{CC}$ .....	$\pm 22V$
PWM, FG, $V_{OUT1/2}$ .....	-0.3V to +22.3V
Continuous power dissipation ( $T_A = 25^\circ C$ ) <sup>(2)</sup> .....	1.25W
Junction temperature .....	150°C
Lead temperature .....	260°C
Storage temperature .....	-60°C to +150°C

**ESD Rating**

Human body model (HBM) .....	2000V
Charged device model (CDM) .....	1000V

**Recommended Operating Conditions** <sup>(3)</sup>

Supply voltage ( $V_{CC}$ ) .....	3.3V to 18V
Operating junction temp ( $T_J$ ) ....	-40°C to +125°C

<b>Thermal Resistance</b> <sup>(4)</sup>	$\theta_{JA}$	$\theta_{JC}$
TSOT23-6 .....	100.....	55... °C/W

**Notes:**

- 1) Exceeding these ratings may damage the device.
- 2) The maximum allowable power dissipation is a function of the maximum junction temperature,  $T_J$  (MAX), the junction-to-ambient thermal resistance,  $\theta_{JA}$ , and the ambient temperature,  $T_A$ . The maximum allowable continuous power dissipation at any ambient temperature is calculated by  $P_D$  (MAX) =  $(T_J$  (MAX) -  $T_A$ ) /  $\theta_{JA}$ . Exceeding the maximum allowable power dissipation produces an excessive die temperature, causing the regulator to go into thermal shutdown. Internal thermal shutdown circuitry protects the device from permanent damage.
- 3) The device is not guaranteed to function outside of its operating conditions.
- 4) Measured on JESD51-7, 4-layer PCB.

## ELECTRICAL CHARACTERISTICS

V<sub>CC</sub> = 12V, T<sub>J</sub> = -40°C to +125°C, unless otherwise noted.

Parameters	Symbol	Condition	Min	Typ	Max	Units
Input UVLO rising threshold	V <sub>UVLO</sub>			3	3.25	V
Input UVLO hysteresis				0.9		V
Operating supply current	I <sub>CC</sub>			6.5		mA
Reverse supply current	I <sub>CCREV</sub>	V <sub>CC</sub> = -18V			1	mA
PWM high-voltage input	V <sub>PWMH</sub>		1.5			V
PWM low-voltage input	V <sub>PWML</sub>				0.4	V
PWM internal pull-up resistance input				41	50	kΩ
HS switch on resistance	R <sub>HSON</sub>	I <sub>O</sub> = 100mA, including reversed MOSFET		620		mΩ
LS switch on resistance	R <sub>LSON</sub>	I <sub>O</sub> = 100mA		400		mΩ
Over-current limit protection threshold	I <sub>OCP</sub>			2.6		A
Output current limit	I <sub>LMT</sub>		1.7	2	2.3	A
PWM output frequency	f <sub>S</sub>		22.1	26	29.9	kHz
FG output low-level voltage	V <sub>FG_L</sub>	IFG = 3mA, V <sub>PULL</sub> = 5V			0.35	V
FG leakage current					1	μA
Soft turn-on angle	θ <sub>SON</sub>	Input PWM duty = 100%		22.5		deg
Soft turn-off angle	θ <sub>SOFF</sub>	Input PWM duty = 100%		45		deg
Rotor-lock detection time	t <sub>RD</sub>			0.6		s
Minimum recommended magnetic field <sup>(5)</sup>				±1		mT
Thermal shutdown threshold <sup>(5)</sup>				150		°C
Thermal shutdown hysteresis <sup>(5)</sup>				25		°C

**Note:**

5) Guaranteed by design.

## TYPICAL PERFORMANCE CHARACTERISTICS

$V_{CC} = 12V$ ,  $T_A = 25^\circ C$ , tested with fan unit, unless otherwise noted.

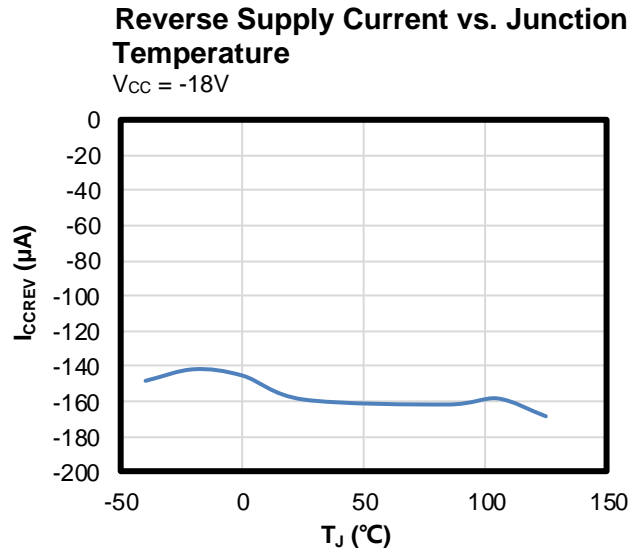
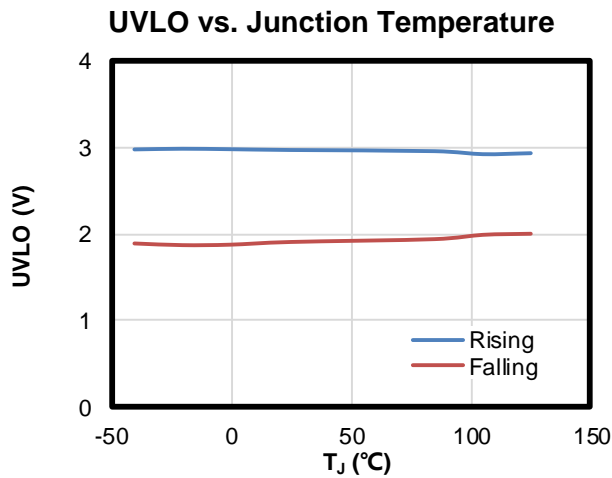
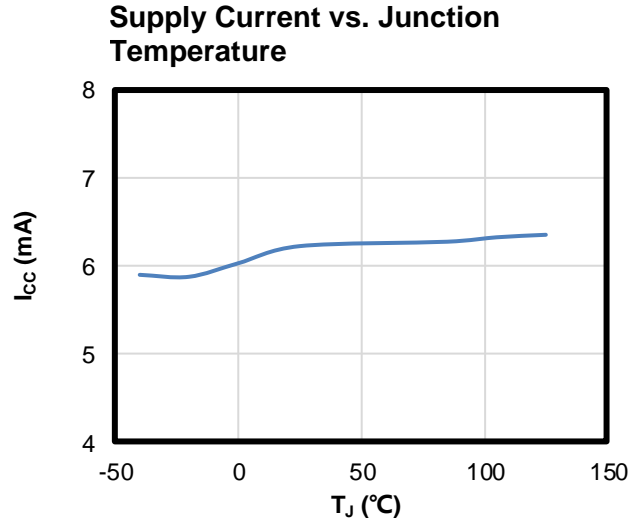
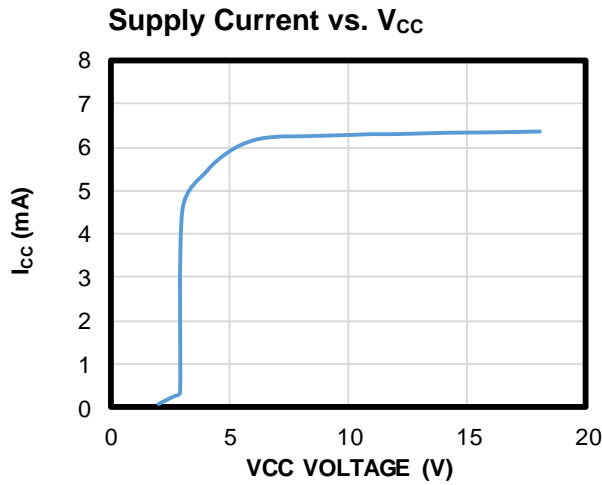

**PWM Output Frequency vs. Junction Temperature**

**Rotor Lock Detection Time vs. Junction Temperature**

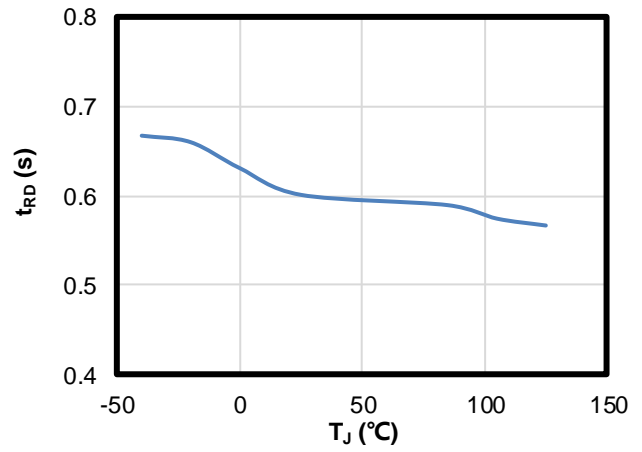
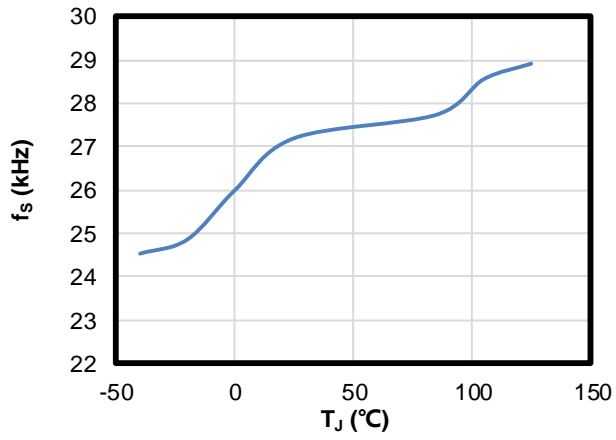

**TYPICAL PERFORMANCE CHARACTERISTICS (continued)**

$V_{CC} = 12V$ ,  $T_A = 25^{\circ}C$ , tested with fan unit, unless otherwise noted.

**Steady State**

$V_{CC} = 12V$ ,  $f_{PWM} = 25kHz$ , duty cycle = 100%

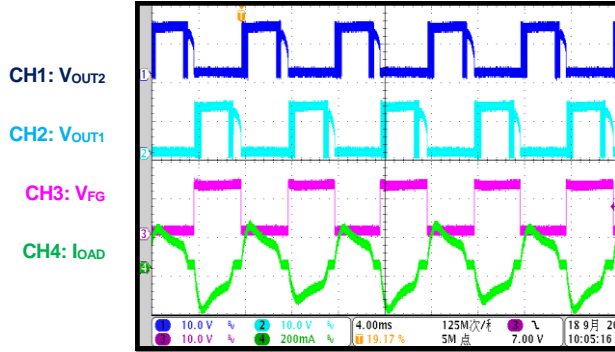

**Steady State**

$V_{CC} = 12V$ ,  $f_{PWM} = 25kHz$ , duty cycle = 50%

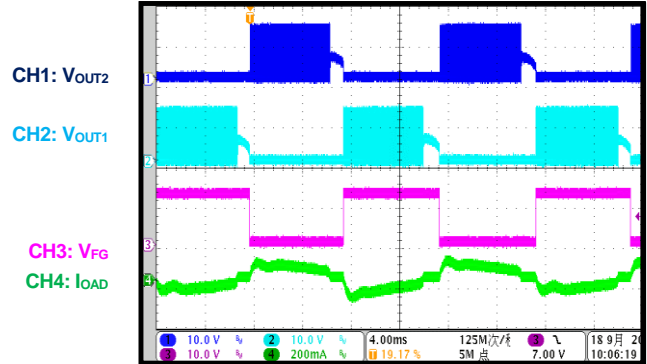

**Start-Up with PWM**

$V_{CC} = 12V$ , PWM = 0V to 5V

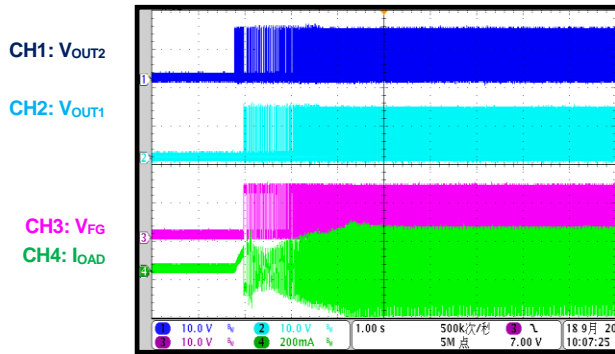

**Shutdown with PWM**

$V_{CC} = 12V$ , PWM = 5V to 0V

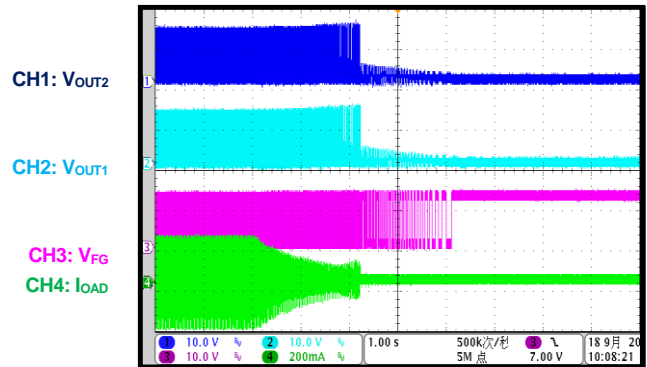

**Input PWM Duty Transition**

$V_{CC} = 12V$ ,  $f_{PWM} = 25kHz$ ,  
duty cycle = 100% to 50%

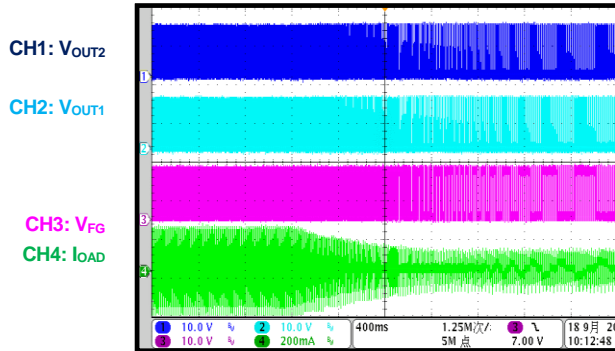

**Input PWM Duty Transition**

$V_{CC} = 12V$ ,  $f_{PWM} = 25kHz$ ,  
duty cycle = 50% to 100%

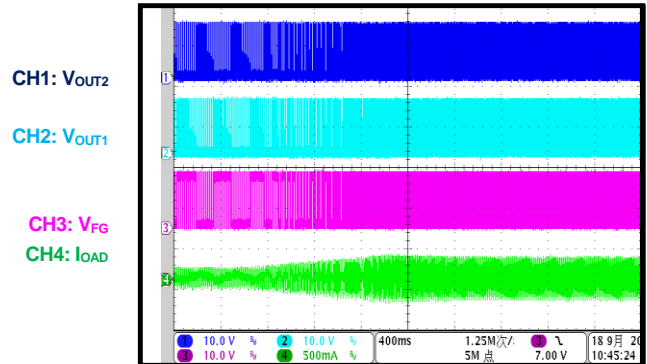



**TYPICAL PERFORMANCE CHARACTERISTICS (continued)**

$V_{CC} = 12V$ ,  $T_A = 25^{\circ}C$ , tested with fan unit, unless otherwise noted.

**Start-Up with VCC**

$V_{CC} = 0$  to  $12V$ , PWM =  $5V$

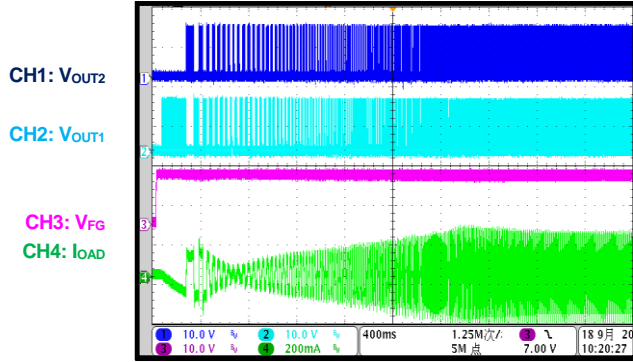

**Shutdown with VCC**

$V_{CC} = 12V$  to  $0V$ , PWM =  $5V$

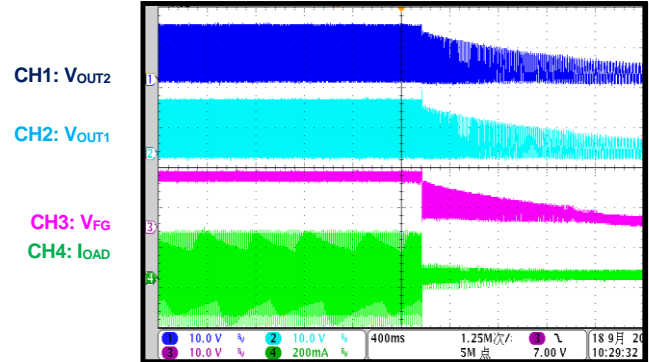

**Rotor Lock and Release**

$V_{CC} = 12V$ , PWM =  $5V$

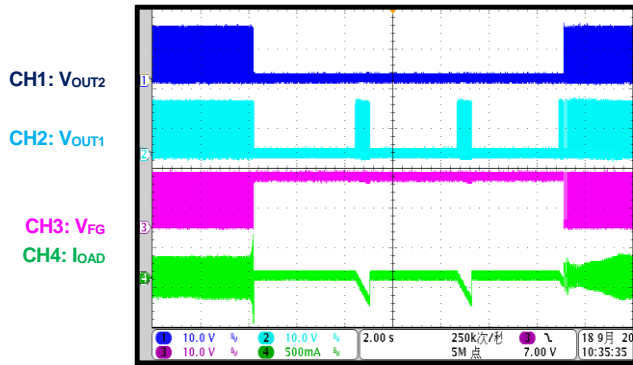

**Reverse Block and Release**

$V_{CC} = -15V$  to  $0V$  to  $15V$ , PWM =  $5V$

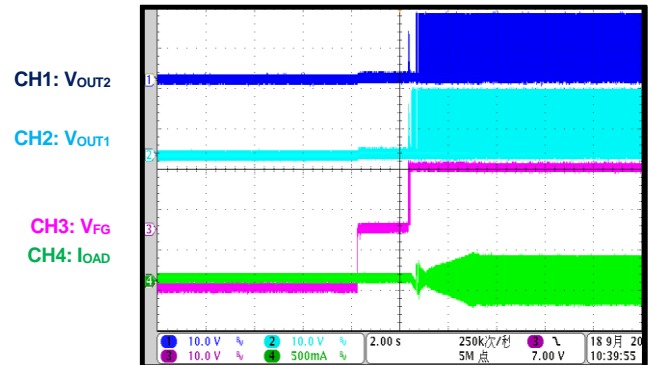

### FUNCTIONAL BLOCK DIAGRAM

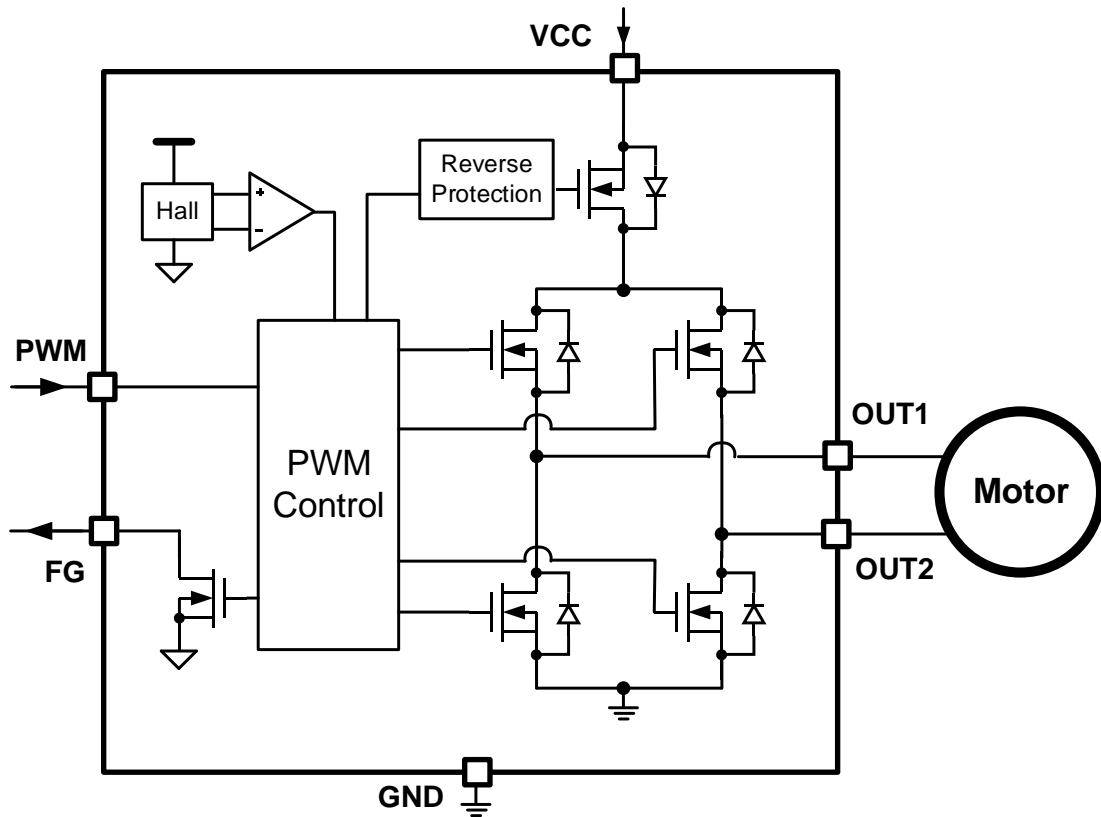

Figure 1: Functional Block Diagram

## OPERATION

The MP9517 is a single-phase, brushless DC motor driver with integrated power MOSFETs and a Hall-effect sensor.

### Speed Control

The MP9517 is controlled using a pulse-width modulation (PWM) input interface, which is compatible with industry-standard devices. The IC detects the PWM input signal duty cycle and linearly controls the H-bridge output duty cycle. This increases the fan speed as the input duty cycle increases.

The PWM input accepts a wide input frequency range (2kHz to 100kHz), while the output frequency is kept constant at 26kHz above the audible frequency range.

### PWM Output Drive

The IC controls H-bridge MOSFET switching to reduce speed variation and increase system efficiency (see Figure 2).

When the rotor magnet pole S comes around, the internal Hall sensor has a high output. When the rotor magnet pole N comes around, the internal Hall sensor has a low output. With this Hall signal, the IC initiates soft-on commutation and soft-off commutation to maintain a smooth current and reduce fan vibration.

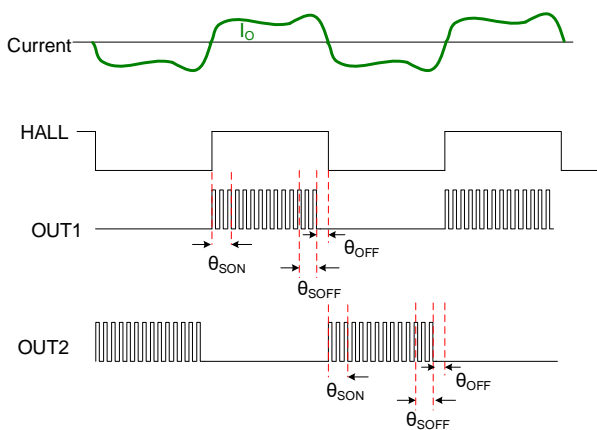

**Figure 2: Timing Diagram**

### Soft Turn-On

During soft turn-on, OUT1 continues switching. The duty cycle increases gradually from 0 to the target duty cycle in a maximum of 16 steps, while OUT2 remains low. The soft-on angle

lasts for 22.5° when the output duty cycle is 100%.

### Normal PWM Switching

During a normal PWM switching cycle, OUT1 continues switching, and the duty cycle is fixed at the target duty. OUT2 remains low.

### Soft Turn-Off

During soft turn-off, OUT1 continues switching. The duty cycle decreases gradually from the target duty cycle to 0 in a maximum of 16 steps, while OUT2 remains low. The soft-on angle lasts for 45° when output duty cycle is 100%.

### Off Section

During this time, OUT1 remains at high impedance. OUT2 remains low. The time duration is adaptive from 0° to 45°. In steady state, this function block maintains the phase lock of the Hall output falling edge and winding current zero-crossing edge.

When the Hall output is low, the conducting phase changes, but the switching sequence remains the same.

### PWM Input Starting Duty Cycle

When the input duty cycle is below 7.8%, the fan remains at zero speed. When the input duty cycle is above 9% (1.2% hysteresis), the fan starts rotating.

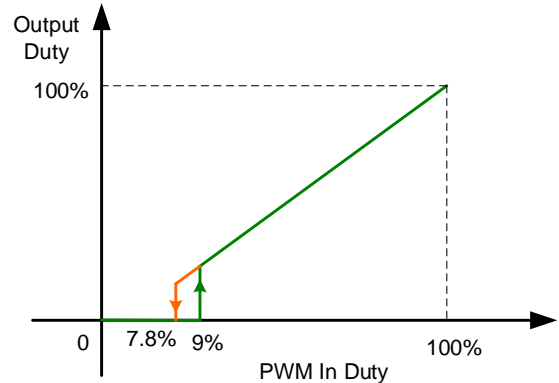

**Figure 3: Start-Up Duty Cycle**

### Protection Circuits

The MP9517 is fully protected from over-voltage, under-voltage, over-current, and over-temperature events. It also has input reverse connection protection.

**Over-Current Protection (OCP)**

The MP9517 protects against internal overload and short circuits by detecting the current flowing through each MOSFET. If the current flowing through any MOSFET exceeds the over-current protection (OCP) threshold beyond the 1.5µs blanking time, that MOSFET turns off immediately.

**Overload Current Limit**

The current flowing through the high-side MOSFET (HS-FET) of the H-bridge is monitored during normal switching. If the current exceeds the overload current limit (about 2A) beyond the 1.5µs blanking time, the HS-FET turns off immediately. The HS-FET resumes switching in the next switching cycle.

**Thermal Shutdown**

Thermal monitoring is also integrated into the MP9517. If the die temperature rises above 150°C, the MOSFETs of the switching half-bridge turn off. Operation resumes automatically once the die temperature drops to a safe level.

**Under-Voltage Lockout (UVLO)**

If at any time  $V_{CC}$  falls below the under-voltage lockout (UVLO) threshold, all circuitry in the device is disabled and the internal logic is reset. Operation resumes when  $V_{CC}$  rises above the UVLO threshold.

**Rotor Deadlock Protection (RDP)**

If the IC cannot see the Hall signal edge change during the 0.6s detection time, both low-side MOSFETs (LS-FETs) turn on. After a 3.6s recovery time, the IC attempts to start up again automatically. FG begins to output again after

the rotor lock condition is removed, and three Hall signal edges are detected (see Figure 4).

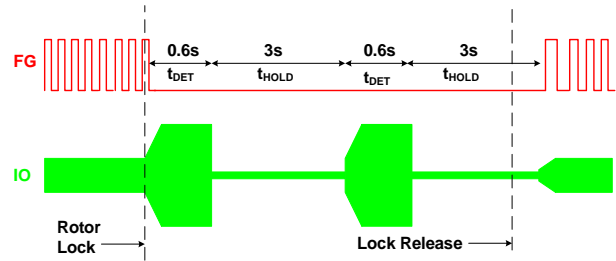

**Figure 4: Rotor Deadlock Protection**

**Rotor Speed Indication (FG)**

The MP9517 outputs a Hall detection signal to FG to indicate speed. The output signal frequency is the internal Hall sensor output frequency. FG is an open drain, so it must have a pull-up resistor.

**Over-Voltage Protection (OVP)**

If  $V_{CC}$  exceeds the over-voltage (OV) threshold (19V), the IC turns off the two HS-FETs. It turns on the two low-side MOSFETs (LS-FET) until  $V_{CC}$  drops below 18V. Then the IC resumes normal operation.

**Input Reverse Connection Protection**

If the input line is reverse connected to VCC and GND, the IC detects the fault condition automatically and shuts down to avoid damage.

**Soft-Start (SS) Time**

To reduce the input rush current when the duty cycle changes, the MP9517 initiates a soft start to smoothly ramp the PWM input reference up and down. The start-up time for soft start is 2.6s.

## APPLICATION INFORMATION

### Selecting the Input Capacitor

Place an input capacitor (C1) near VCC to keep the input voltage stable and reduce input switching voltage noise and ripple. The input capacitor impedance must be low at the switching frequency. It is recommended to use ceramic capacitors with X7R dielectrics due to their low ESR.

Ceramic capacitance is dependent on the voltage rating. The DC bias voltage and value can lose as much as 50% of its capacitance at its rated voltage level. Leave a sufficient voltage rating margin when selecting the component. For most applications, a 0.1µF to 2.2µF ceramic capacitor is sufficient. In some applications, add an additional, large electrolytic capacitor to absorb inductor energy.

### Input Snubber

Due to the input capacitor energy the charges and discharges during the phase commutation soft switching, the input current has switching

cycle ringing. To help prevent this, add a 2Ω resistor in series with a input capacitor to form an R-C.

An optional TVS can be placed in parallel with the input capacitor to prevent the IC from being damaged by a high-power, large inertia fan.

### Hall Sensor Position

The Hall sensor cell is located in the lower-left corner of the package (see Figure 5).

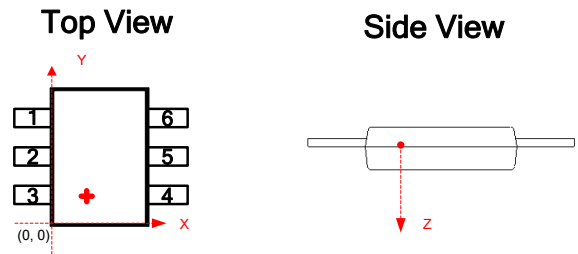

(X, Y, Z) = (540µm, 508µm, 80µm)

**Figure 5: Hall Sensor Position**

**TYPICAL APPLICATION CIRCUIT**

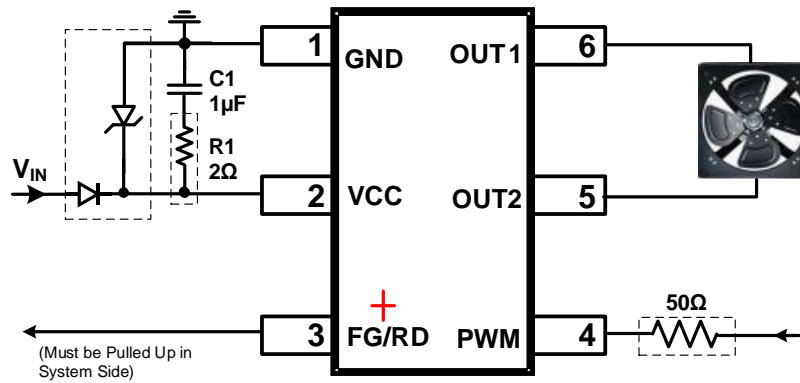

**Figure 6: Typical Application Circuit for 12V VCC Input**

**PACKAGE INFORMATION**

**TSOT23-6-L**

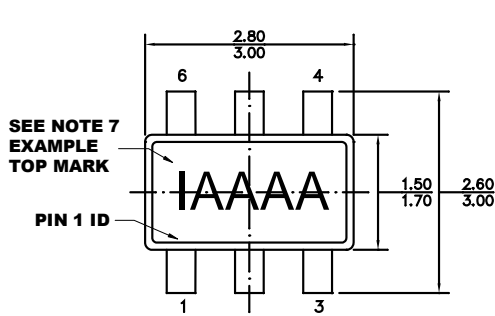

**TOP VIEW**

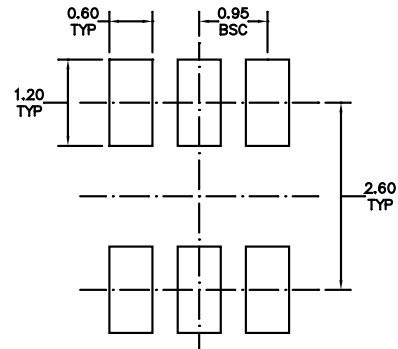

**RECOMMENDED LAND PATTERN**

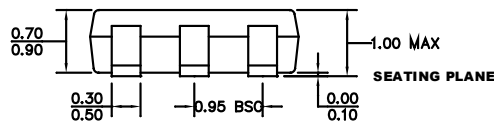

**FRONT VIEW**

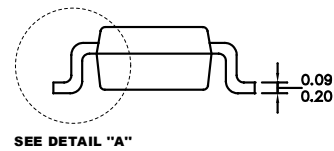

SEE DETAIL "A"

**SIDE VIEW**

**NOTE:**

- 1) ALL DIMENSIONS ARE IN MILLIMETERS.
- 2) PACKAGE LENGTH DOES NOT INCLUDE MOLD FLASH, PROTRUSION, OR GATE BURR.
- 3) PACKAGE WIDTH DOES NOT INCLUDE INTERLEAD FLASH OR PROTRUSION.
- 4) LEAD COPLANARITY (BOTTOM OF LEADS AFTER FORMING) SHALL BE 0.10 MILLIMETERS MAX.
- 5) DRAWING CONFORMS TO JEDEC MO-193, VARIATION AB.
- 6) DRAWING IS NOT TO SCALE.
- 7) PIN 1 IS LOWER-LEFT PIN WHEN READING TOP MARK FROM LEFT TO RIGHT (SEE EXAMPLE TOP MARK).

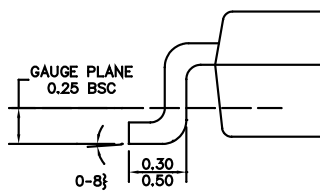

**DETAIL "A"**

**PACKAGE INFORMATION**

**TSOT23-6-SL**

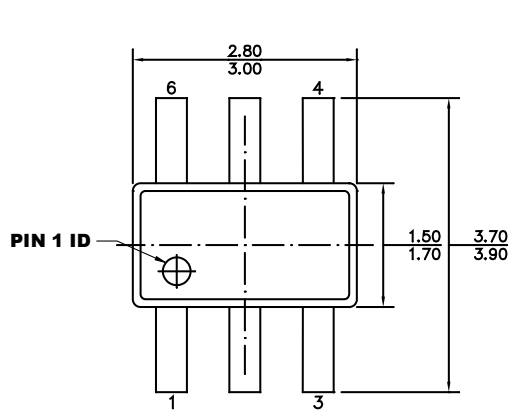

**TOP VIEW**

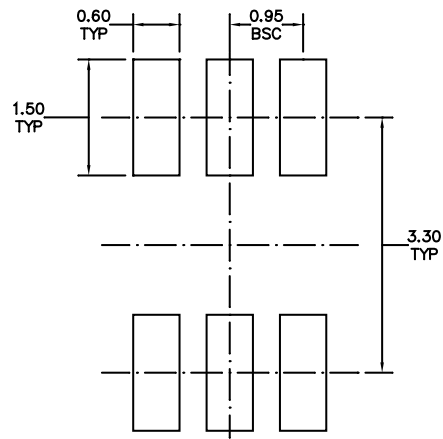

**RECOMMENDED LAND PATTERN**

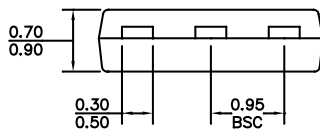

**FRONT VIEW**

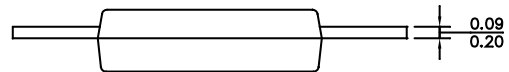

**SIDE VIEW**

**NOTE:**

- 1) ALL DIMENSIONS ARE IN MILLIMETERS.
- 2) PACKAGE LENGTH DOES NOT INCLUDE MOLD FLASH, PROTRUSION, OR GATE BURR.
- 3) PACKAGE WIDTH DOES NOT INCLUDE INTERLEAD FLASH OR PROTRUSION.
- 4) LEAD COPLANARITY (BOTTOM OF LEADS AFTER FORMING) SHALL BE 0.10 MILLIMETERS MAX.
- 5) DRAWING REFERENCE IS JEDEC MO-193.
- 6) DRAWING IS NOT TO SCALE.



## CARRIER INFORMATION

### TOST23-6-L and TOST23-6-SL

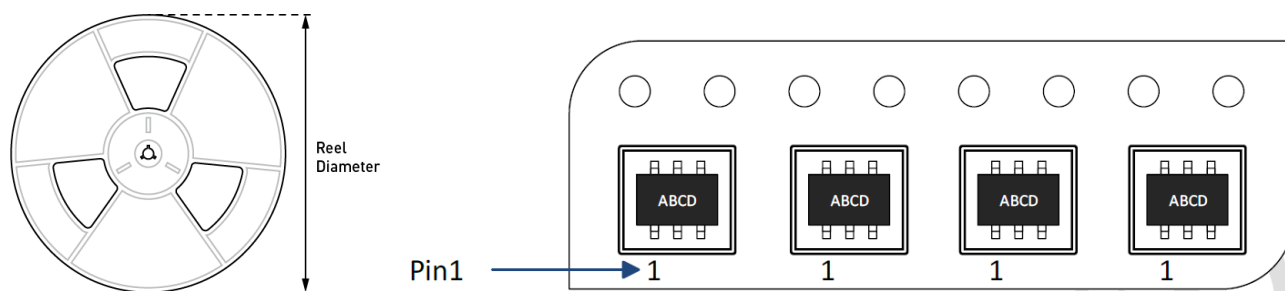

Part Number	Package Description	Quantity/ Reel	Quantity/ Tube	Reel Diameter	Carrier Tape Width	Carrier Tape Pitch
MP9517GJS-Z	TSOT23-6-SL	5000	N/A	13in	12mm	8mm
MP9517GJL-Z	TSOT23-6-L	5000	N/A	13in	12mm	8mm

Revision History

Revision #	Revision Date	Description	Pages Updated
1.0	4/22/2020	Initial Release	-

**Notice:** The information in this document is subject to change without notice. Users should warrant and guarantee that third-party Intellectual Property rights are not infringed upon when integrating MPS products into any application. MPS will not assume any legal responsibility for any said applications.

# Mouser Electronics

Authorized Distributor

Click to View Pricing, Inventory, Delivery & Lifecycle Information:

[Monolithic Power Systems \(MPS\):](#)

[MP9517GJS-Z](#)