

DESCRIPTION

The EV7722DF-02A is the evaluation board for the MP7722. The MP7722 is a stereo 20W Class D Audio Amplifier. It is one of MPS' second generation of fully integrated audio amplifiers which dramatically reduces solution size by integrating the following:

- 180mΩ power MOSFETs
- Startup / Shutdown pop elimination
- Short circuit protection circuits
- Mute / Standby

The MP7722 utilizes a single ended output structure with capacitor divider configuration capable of delivering 2x20W into 4Ω speakers. MPS Class D Audio Amplifiers exhibit the high fidelity of a Class A/B amplifier at efficiencies greater than 90%. The circuit is based on the MPS' AAM™ proprietary variable frequency topology that delivers excellent linearity, fast response time and operates on a single power supply.

ELECTRICAL SPECIFICATIONS

Parameter	Symbol	Value	Units
Supply Voltage	V _{DD}	24	V

FEATURES

- 20W Output at V_{DD} = 24V into a 4Ω load
- THD+N = 0.08% at 1W, 8Ω
- 90% Efficiency at 20W
- 9.5V to 24V Operation from a Single Supply
- Mute/Standby Modes (Sleep)

APPLICATIONS

- Flat Panel and Projection Televisions
- DVD and Surround Sound Systems
- Flat Panel Monitors
- Multimedia Computers
- Home Stereo Systems

"MPS" and "The Future of Analog IC Technology" are Registered Trademarks of Monolithic Power Systems, Inc.

AAM (Analog Adaptive Modulation) is a Trademark of Monolithic Power Systems, Inc.

EV7722DF-02A EVALUATION BOARD

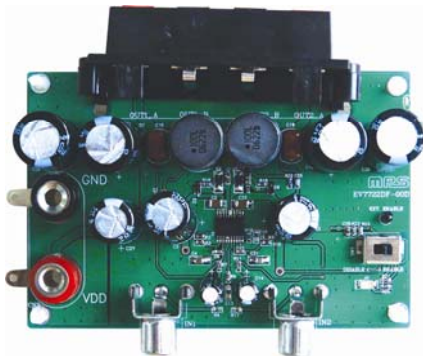

(L x W x H) 3.5" x 2.4" x 1.2"
8.9cm x 6.1cm x 3.0cm

Board Number	MPS IC Number
EV7722DF-02A	MP7722DF

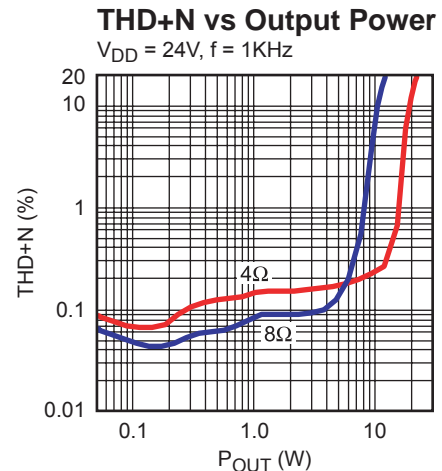

EVALUATION BOARD SCHEMATIC

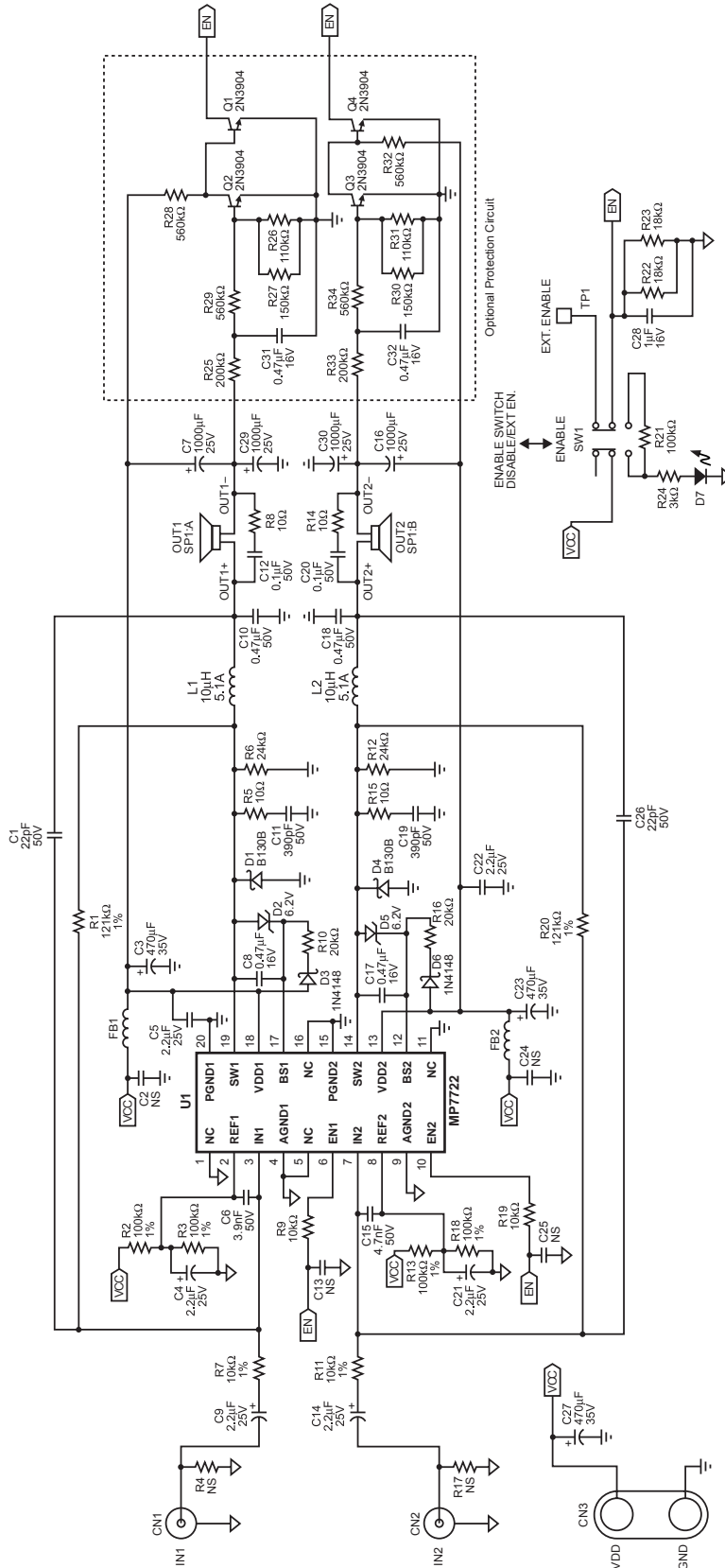

EV7722DF-02A BILL OF MATERIALS

Qty	Ref	Value	Description	Package	Manufacturer P/N
2	C1, C26	22pF	Ceramic Capacitor, 50V, C0G	0603	Murata: GRM1885C1H220JA01
4	C2, C13, C25, C24		Not stuffed		
3	C3, C23, C27	470µF	Electrolytic Capacitor, 470uF, 35V, YXF	Radial	Rubycon: 35YXF470M
4	C4, C9, C14, C21	2.2µF	Electrolytic Capacitor, 25V, YXF	Radial	Rubycon: 25YXF2M2
2	C5, C22	2.2µF	Ceramic Capacitor, 25V, X7R	1206	Murata: GRM31MR71E225KA93
1	C6	3.9nF	Ceramic Capacitor, 50V, X7R	0603	Murata: GRM188R71H392KA01
4	C7, C16, C29, C30	1000µF	Electrolytic Capacitor, 25V, YXF	Radial	Rubycon: 25VYXF1000M
4	C8, C17, C31, C32	0.47µF	Ceramic Capacitor, 16V, X7R	0603	Murata: GRM188R71C474KA88D
2	C10, C18	0.47µF	Film Capacitor, 50V, X7R	Radial	Any
2	C11, C19	390pF	Ceramic Capacitor, 50V, C0G	0603	Murata: GRM1885C1H3901JA01
2	C12, C20	0.1µF	Ceramic Capacitor, 50V, X7R	0603	Murata: GRM188R71H104KA993D
1	C15	4.7nF	Ceramic Capacitor, 50V, X7R	0603	Murata: GRM188R71H472KA01
1	C28	1µF	Ceramic Capacitor, 16V, X7R	0805	Murata: GRM21BR71C105KA01L
2	CN1, CN2		Phone Jack, Female	RCA	Any
1	CN3		Banana Jack Connector		Any
2	D1, D4		Schottky Diode, 1A/30V	SMB	Diodes: B130B-13-F
2	D2, D5	6.2V	Zener Diode, 6.2V/250mW	SOD323	Diodes Inc.: BZT52C6V2S
2	D3, D6		Diode Switch, 75V, 100mA	SOD323	Diodes: 1N4148
1	D7		LED	1206	Any
2	FB1, FB2		Fuse, Ferrite Bead, 4A	BS43	Toko: BS43
2	L1, L2	10µH	Inductor (13RHBP), 5.1A	Radial	Toko: 13RHBP-A7502BY-100M
4	Q1, Q2, Q3, Q4		NPN Transistor, 2N3904	SOT23	On Semi: MMBT3904

EV7722DF-02A BILL OF MATERIALS (continued)

Qty	Ref	Value	Description	Package	Manufacturer P/N
2	R1, R20	121kΩ	Resistor, 1%	0603	Yageo: RC0603FR-07120KL
4	R2, R3, R13, R18	100kΩ	Resistor, 1%	0603	Yageo: RC0603FR-07100KL
2	R4, R17	NS	Not Stuffed		
2	R5, R15	10Ω	Resistor, 5%	0603	Yageo: RC0603JR-0710RL
2	R6, R12	24kΩ	Resistor, 5%	0603	Yageo: RC0603JR-0725RL
2	R7, R11	10kΩ	Resistor, 1%	0603	Yageo: RC0603FR-0710KL
2	R8, R14	10Ω	Resistor, 5%	1206	Yageo: RC1206JR-0710RL
2	R9, R19	10kΩ	Resistor, 5%	0603	Yageo: RC0603JR-0710KL
2	R10, R16	20kΩ	Resistor, 5%	0603	Yageo: RC0603JR-0720KL
1	R21	100kΩ	Resistor, 5%	0603	Yageo: RC0603JR-07100KL
2	R22,R23	18kΩ	Resistor, 5%	0603	Yageo: RC0603JR-0718KL
1	R24	3kΩ	Resistor, 5%	0603	Yageo: RC0603JR-073KL
2	R25, R33	200kΩ	Resistor, 5%	0603	Yageo: RC0603JR-07200KL
4	R28, R29, R32, R34	560kΩ	Resistor, 5%	0603	Yageo: RC0603JR-07560KL
2	R26, R31	110kΩ	Resistor, 5%	0603	Any
2	R27, R30	150kΩ	Resistor, 5%	0603	Any
1	SP1		Speaker Connector, Red and Black		Any
1	SW1		Switch slide, 12V, 0.1A		Any
1	TP1		Pin (Test Point)		Any
1	U1		MPS AUDIO IC MP7722DF	TSSOP20F	MPS: MP7722DF

TYPICAL PERFORMANCE CHARACTERISTICS

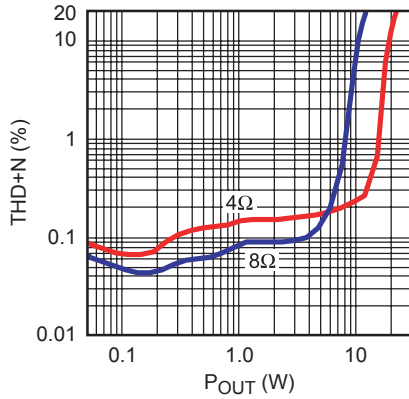
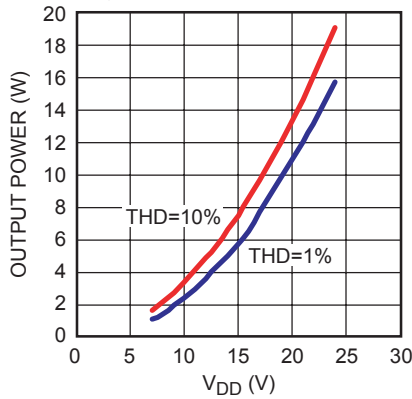
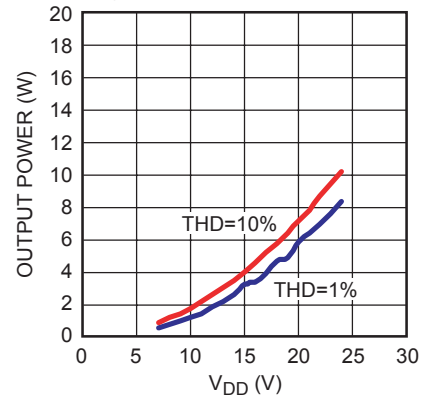
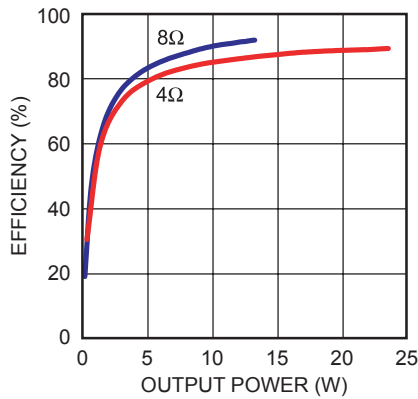
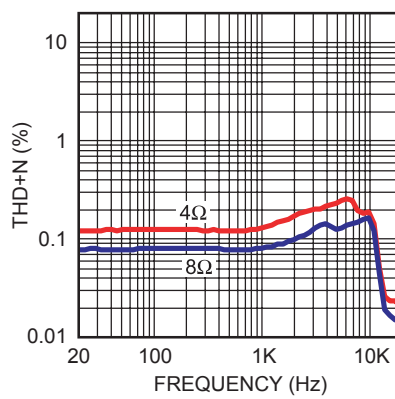
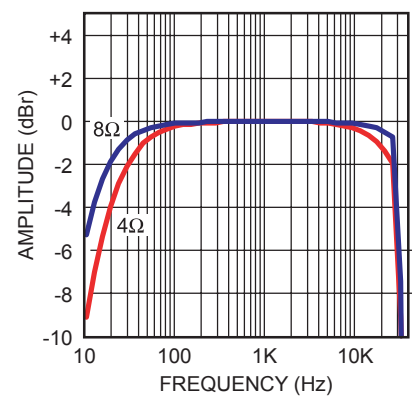
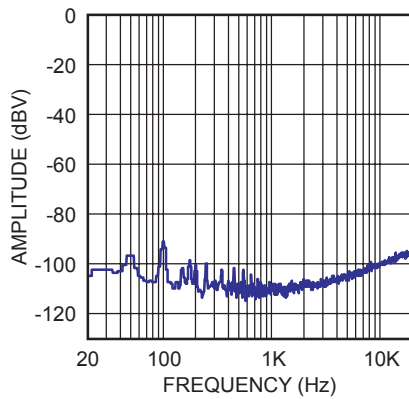
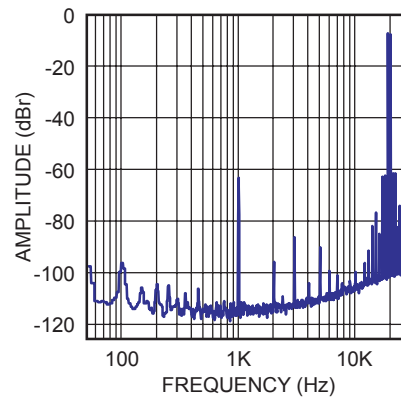
THD+N vs Output Power
 $V_{DD} = 24V, f = 1KHz$

Output Power vs V_{DD}
 $R_{LOAD} = 4\Omega, f = 1KHz$

Output Power vs V_{DD}
 $R_{LOAD} = 8\Omega, f = 1KHz$

Efficiency vs Output Power
 $V_{DD} = 24V$

THD+N vs Frequency
 $V_{DD} = 24V, 1W$

Frequency Response
 $V_{DD} = 24V, A_V = 12$

FFT Noise Floor
 $V_{DD} = 24V, A\text{-wtd}, 4\Omega$

IHF-IMD
 $V_{DD} = 24V, A\text{-wtd}, 4\Omega, A_V = 12$

PRINTED CIRCUIT BOARD LAYOUT

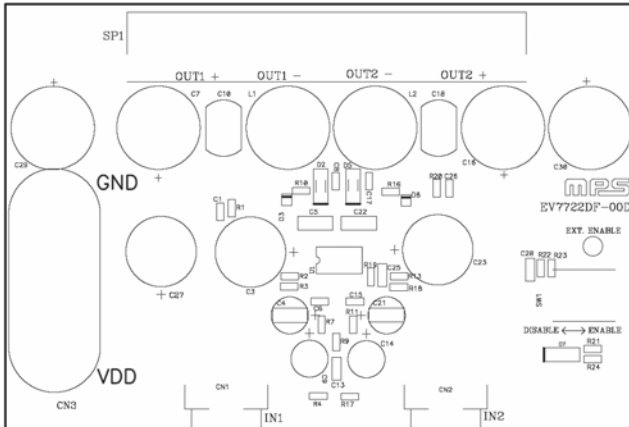

Figure 1—Top Silk Layer

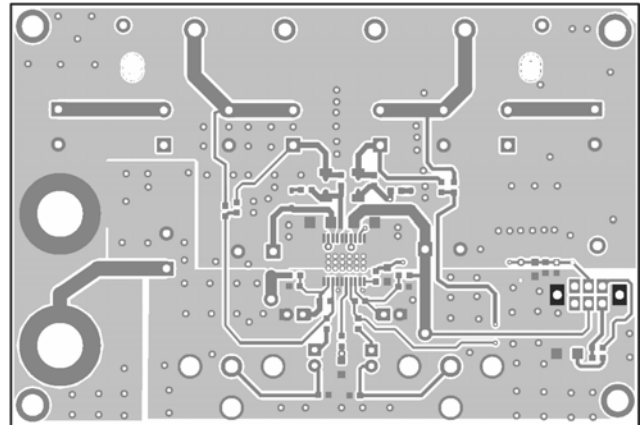

Figure 2—Top Layer

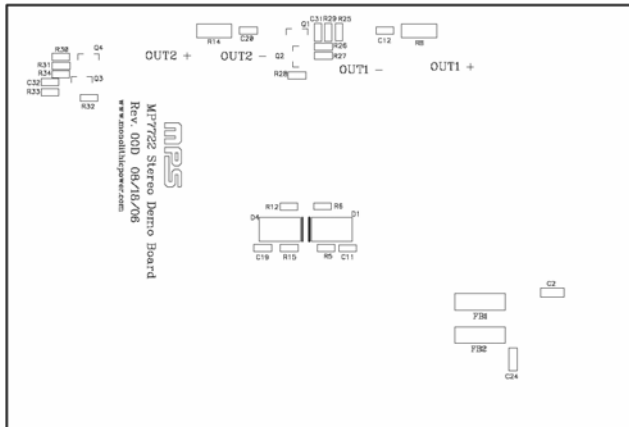

Figure 3—Bottom Silk Layer

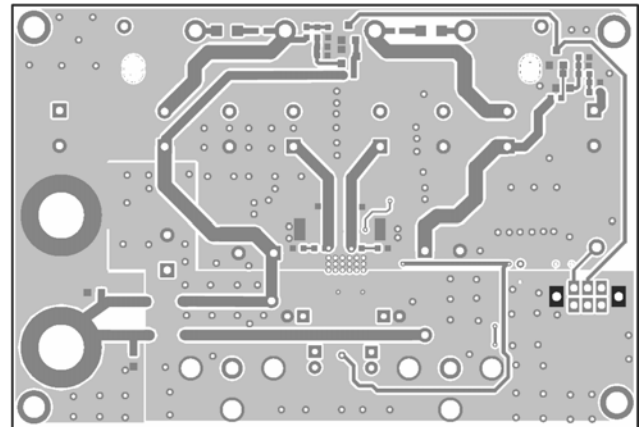

Figure 4—Bottom and Bottom Silk Layer

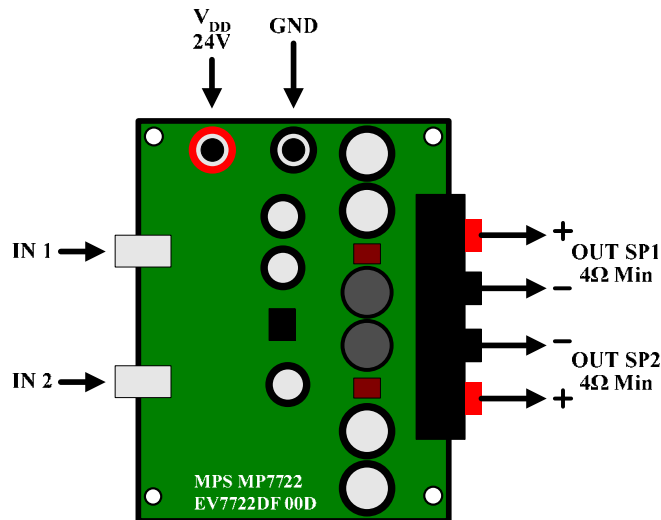

Figure 5—Connection Diagram

QUICK START GUIDE

This board is set up from the factory for 24V operation. To use with a 12V power supply adjust the components as specified in the 12V operation Section 3 below. For more information, consult the MP7722 datasheet.

1. Power Requirements
 - a. Power Supply: 24V, 6A maximum.
 - b. $0V_{RMS}$ to $1V_{RMS}$ (Max) audio signal source.
 - c. Speaker: 4Ω or 8Ω
2. Setup Condition for 24V Operation
 - a. Connect the outputs to the external speakers.
 - b. Adjust the power supply to 24V (do not turn on).
 - c. Connect the power supply to the VDD terminals.
 - d. Set the enable switch to the DISABLE position.
 - e. Connect the audio input signal source to the amplifier inputs (IN1, IN2).
 - f. Turn on the power supply to apply power to the board.
3. 12V Operation Modifications
 - a. Change C6 to 1.8nF and C15 to 2.2nF.
 - b. Remove R23, R26 and R31. Change R10 and R16 from $20k\Omega$ to $10k\Omega$
 - c. Adjust the power supply to 12V (do not turn on).
 - d. Use same procedure for turn on as specified in Section 2.
4. Music Turn-On Sequence
 - a. Set the enable switch to the ENABLE position.
 - b. Audio should be heard from the speaker(s).
5. Music Turn-Off Sequence
 - a. Set the enable switch to the DISABLE position.

NOTICE: The information in this document is subject to change without notice. Users should warrant and guarantee that third party Intellectual Property rights are not infringed upon when integrating MPS products into any application. MPS will not assume any legal responsibility for any said applications.

Mouser Electronics

Authorized Distributor

Click to View Pricing, Inventory, Delivery & Lifecycle Information:

[Monolithic Power Systems \(MPS\):](#)

[EV7722DF-02A](#)