



The Future of Analog IC Technology®

EV2624-L-00A

I²C Controlled 4.5A Single Cell USB / Adaptor Charger
with Narrow VDC Power Path Management
and USB OTG

DESCRIPTION

The MP2624 is a 4.5A, highly integrated, switching-mode battery charger IC for single-cell Li-ion or Li-polymer batteries. This device supports NVDC architecture with power path management suitable for different portable applications, such as tablets, MID, and smart phones. Its low impedance power path optimizes efficiency, reduces battery charging time, and extends battery life. The I²C serial interface with charging and system settings allows the device to be controlled flexibly.

The MP2624 supports a wide range of input sources, including standard USB host ports and higher power wall adapters. The MP2624 detects the input source type according to the USB Battery Charging Spec 1.2 (BC1.2) and then informs the host to set the proper input current limit. Also, this device is compliant with USB2.0 and USB3.0 power specifications by adopting a proper input current and voltage regulation scheme. In addition, the MP2624 supports USB On-The-Go operation by supplying 5V with current up to 2.0A.

The power path management regulates the system voltage slightly above the set maximum voltage between the battery voltage and the I²C programmable lowest voltage level (e.g. 3.6V). With this feature, the system is able to operate even when the battery is depleted completely or removed. When the input source current or voltage limit is reached, the power path management reduces automatically the charge current to meet the priority of the system power requirement. If the system current continues increasing, even when the charge current is reduced to zero, the supplement mode allows the battery to power both the system together with the input power supply at the same time.

FEATURES

- High Efficiency 4.5A 1.7MHz Buck Charger and 1.7MHz 2.0A Boost Mode to Support OTG
 - 94% Efficiency @ 2A, 92% @ 4A
 - Fast Charge Time by Battery Path Impedance Compensation
 - USB OTG
 - 94% Efficiency @ 5V, 1.2A OTG
 - Selectable OTG Current Outputs
- 3.9V to 7.0V Operating Input Voltage Range
- Highest Battery Discharge Efficiency with 10mΩ Battery Discharge MOSFET up to 9A
- Single Input USB Compliant Charge
- Narrow System Bus Voltage Power Path Management
 - Instant On Works with No Battery or Deeply Discharged Battery
 - Ideal Diode Operation in Battery Supplemental Mode
- Constant-Off-Time Control to Reduce Charging Time under Low Input Voltages
- High Accuracy of Charging Parameter
- I²C Port for Flexible System Parameter Setting and Status Reporting
- Full DISC Control to Support Shipping Mode
- High Integration
 - Fully Integrated Power Switches and No External Blocking Diode and Sense Resistor Required
 - Built-In Robust Charging Protection including Battery Temperature Monitor and Programmable Timer
 - Built-In Battery Disconnection Function
- High Accuracy
 - ±0.5% Charge Voltage Regulation
 - ±5% Charge Current Regulation
 - ±5% Input Current Regulation
 - ±2% Output Regulation in Boost Mode
- Safety
 - Battery Temperature Sensing for Charge Mode
 - Battery Charging Safety Timer

ELECTRICAL SPECIFICATION

Parameter	Symbol	Value	Units
Input Voltage		3.9 – 7.0	V
Charge Full Voltage		4.2 / I ² C	V
Charge Current		4.5 / I ² C	A
Input Voltage Regulation		4.7 / I ² C	V
Input Current Limit		3.0 / I ² C	A
OTG Voltage Regulation		5.1 / I ² C	V
OTG Current Limit		1.3 / I ² C	A

APPLICATIONS

- Tablet PCs
- Smart Phones
- Mobile Internet Devices

All MPS parts are lead-free, halogen free, and adhere to the RoHS directive. For MPS green status, please visit MPS website under Quality Assurance.
 "MPS" and "The Future of Analog IC Technology" are Registered Trademarks of Monolithic Power Systems, Inc.

EV2624-L-00A EVALUATION BOARD

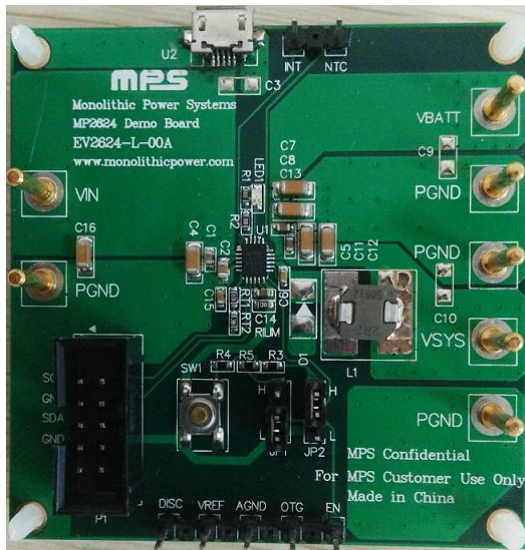

(L x W x H) 6.3cm x 6.3cm x 1.3cm

Board Number	MPS IC Number
EV2624-L-00A	MP2624GL

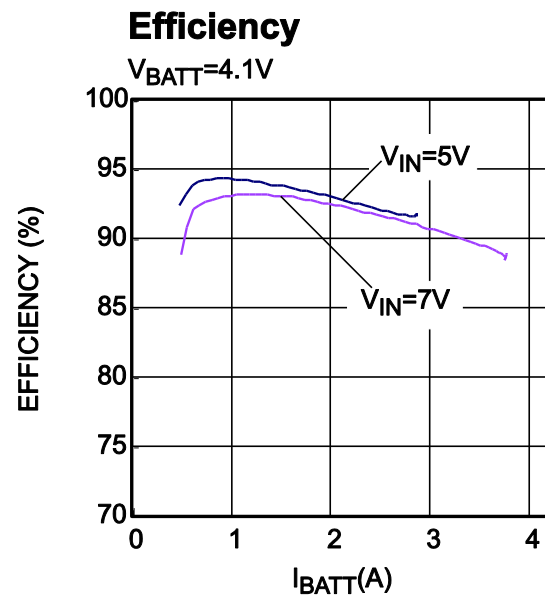

EVALUATION BOARD SCHEMATIC

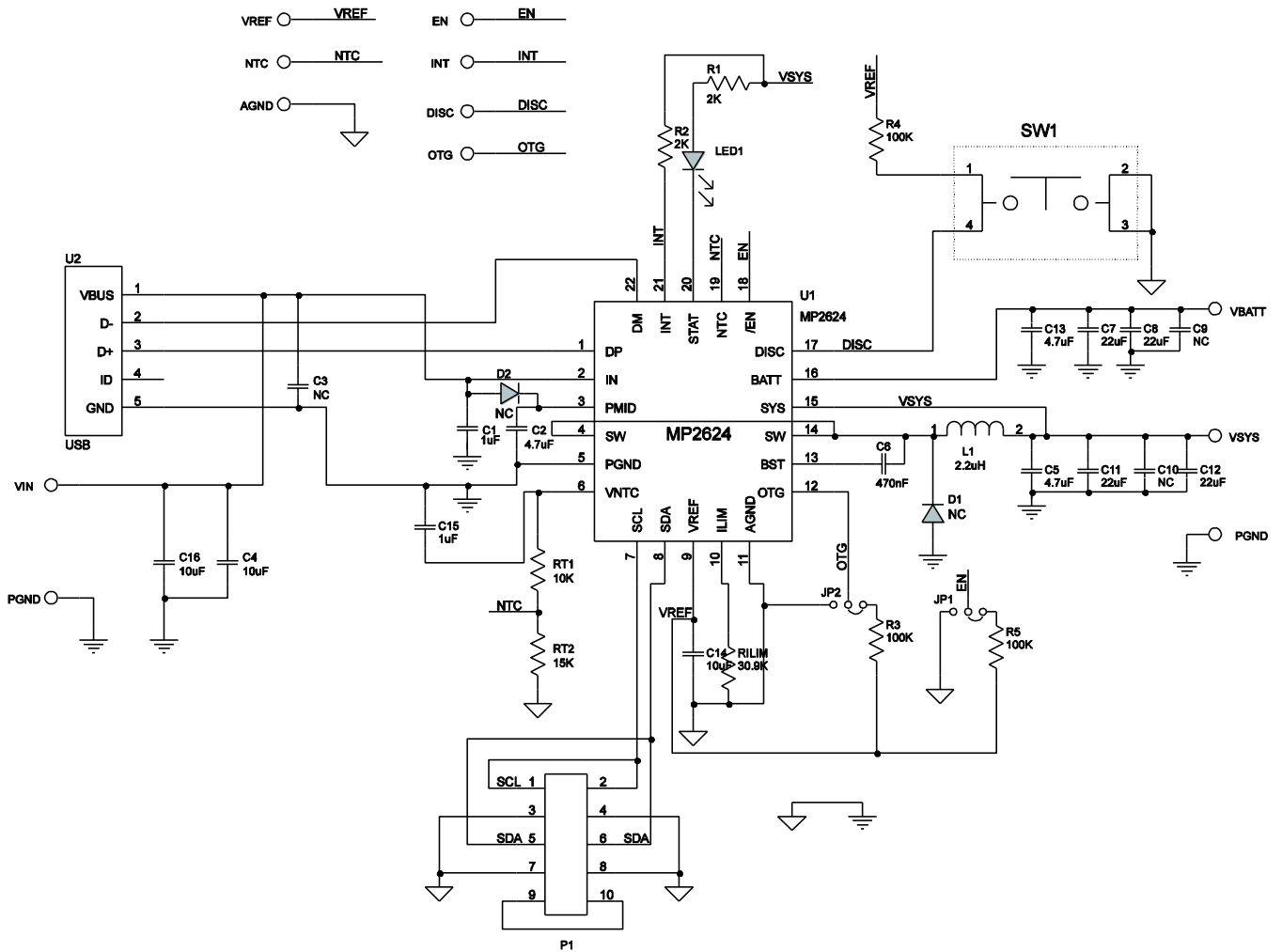

EV2624-L-00A BILL OF MATERIALS

Qty	Ref	Value	Description	Package	Manufacture	Manufacture_PN
1	C1	1 μ F	Ceramic Capacitor;25V;X7R;0603;	0603	muRata	GRM188R71E105KA12D
1	C2	4.7 μ F	Ceramic Capacitor;25V;X5R;0805;	0805	muRata	GRM21BR61E475KA12L
1	C3	NC	Ceramic Capacitor;25V;X5R;1206;	1206	muRata	GRM31CR61E106KA12L
1	C4,C16	10 μ F	Ceramic Capacitor;25V;X5R;1206;	1206	muRata	GRM31CR61E106KA12L
1	C5,C13	4.7 μ F	Ceramic Capacitor;16V;X7R;0805	0805	muRata	GRM21BR71C475KA73L
1	C6	470nF	Ceramic Capacitor;25V;X5R;0603;	0603	muRata	GRM188R61E474KA12D
4	C7, C8, C11, C12	22 μ F	Ceramic Capacitor;10V;X7R;1206	1206	muRata	GRM31CR71A226KE15L
2	C9, C10	NC	Ceramic Capacitor;16V;X5R;0805;	0805	muRata	GRM21BR61C475KA88
1	C14	10 μ F	Ceramic Capacitor;16V;X5R;0603	0603	muRata	GRM188R61C106KAALD
1	C15	1 μ F	Ceramic Capacitor;16V;X7R;0603;	0603	muRata	GRM188R71C105KA12D
1	D1,D2	NC	Diode;50V;3A;	SMA	HQ	B350A-13-F
1	L1	2.2 μ H	Inductor;2.2uH;17.3m;8.2 A	SMD	TDK	SPM6530T-2R2M
1	LED1	BL-HUF35 A-TRB	LED;Red	0805	BRIGHT LED	BL-HUF35A-TRB
2	R1, R2	2k	Film Resistor;1%;	0603	Yageo	RC0603FR-072KL
5	R3, R4, R5	100k	Film Resistor;5%;	0603	Yageo	RC0603JR-07100KL
1	RILIM	1k	Film Resistor;1%	0603	Yageo	RC0603FR-071KL
1	RT1	10k	Film Resistor;1%	0603	Yageo	RC0603FR-0710KL
1	RT2	15k	Film Resistor;1%;	0603	Yageo	RC0603FR-0715KL
1	SW1		Button;SM 4x10mm;1.5mm Height			
4	JP1, JP2,		2.54mm Connector;			
4	JP1, JP2,		2.54mm Connector;短接帽			
1	P1		Header, 5-Pin, Dual row			
7	DISC,V REF,AG ND,OT G,EN,IN T,NTC		2.54mm Connector;			

EV2624-L-00A BILL OF MATERIALS (continued)

Qty	Ref	Value	Description	Package	Manufact ure	Manufacture_PN
6	VIN, PGND,V BATT,P GND,P GND,VS YS		2mm			
1	U1		IC;	FCQFN3*4	MPS	MP2624GL
1	U2		Micro-B USB connector;			

EVB TEST RESULTS

$V_{IN} = 5.0V$, $V_{BATT} = \text{full range}$, I^2C controlled, $I_{CHG} = 4.5A$, $I_{IN_LMT} = 3.0A$, $V_{IN_REG} = 4.36V$, $L1 = 2.2\mu H$,
 $T_A = 25^\circ C$, unless otherwise noted.

Battery Charge Curve

$V_{IN}=5V$, $I_{SYS}=0A$

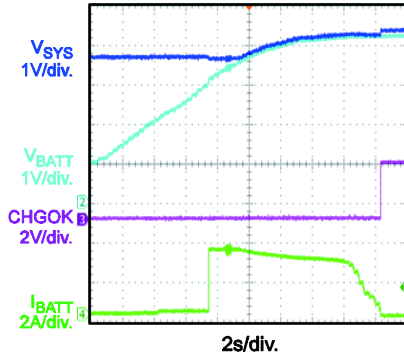

Auto Recharge

$V_{IN}=5V$, $I_{SYS}=0A$

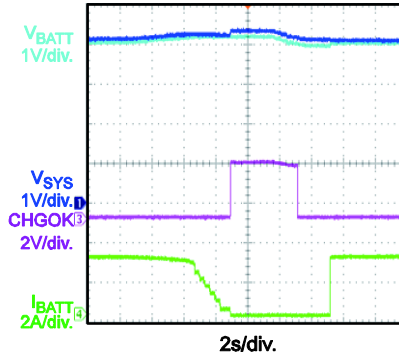

Trickle Charge Steady State

$V_{IN}=5V$, $V_{BATT}=2.8V$

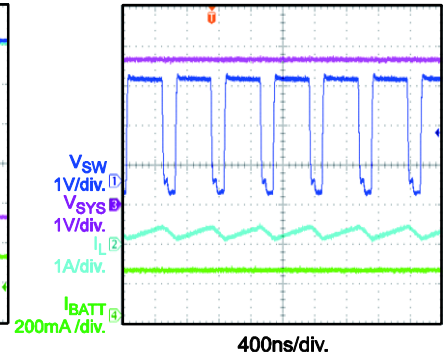

Constant Current Charge Steady State

$V_{IN}=5V$, $V_{BATT}=3.6V$

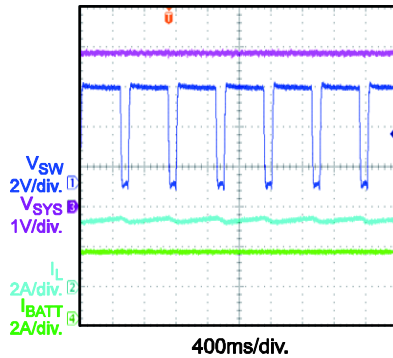

Constant Voltage Charge Steady State

$V_{IN}=5V$, $V_{BATT}=4.2V$

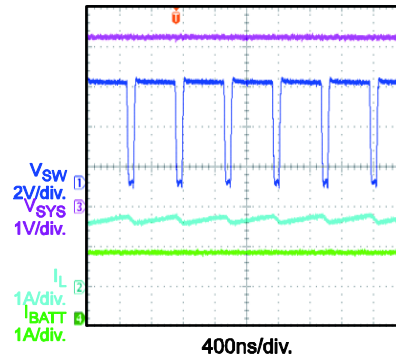

COT Operation

$V_{IN}=4.5V$

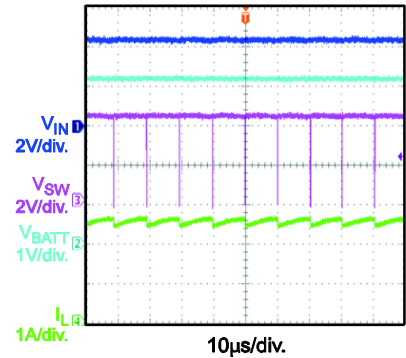

Input Current Limit

$V_{IN}=5V$, $V_{BATT}=4.2V$, $I_{CHG}=3.5A$

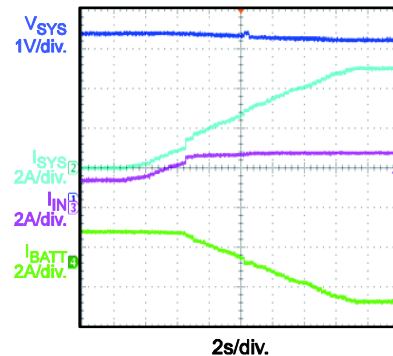

Input Voltage Limit

$V_{IN}=5V/1.0A$, $V_{BATT}=2.8V$, $I_{CHG}=2A$

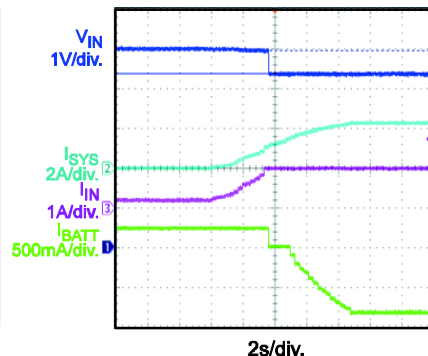

Power On

$V_{IN}=5V$, $V_{BATT}=3.7V$

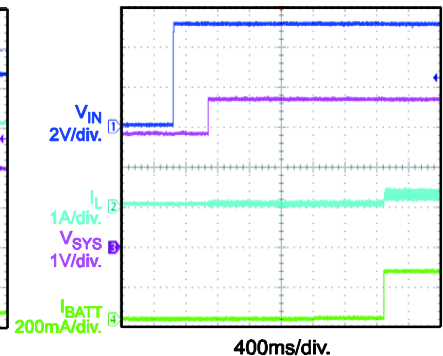

EVB TEST RESULTS (continued)

$V_{IN} = 5.0V$, $V_{BATT} = \text{full range}$, I²C controlled, $I_{CHG} = 4.5A$, $I_{IN_LMT} = 3.0A$, $V_{IN_REG} = 4.36V$, $L1 = 2.2\mu H$, $T_A = 25^\circ C$, unless otherwise noted.

Power Off
 $V_{IN}=5V$, $V_{BATT}=3.7V$

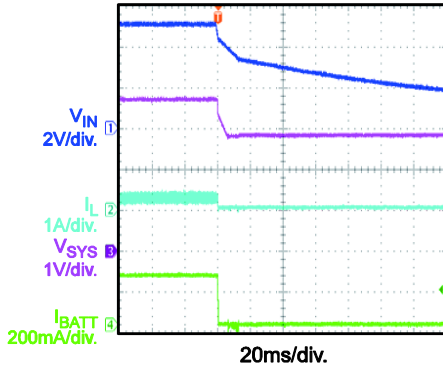

EN On
 $V_{IN}=5V$, $V_{BATT}=3.7V$

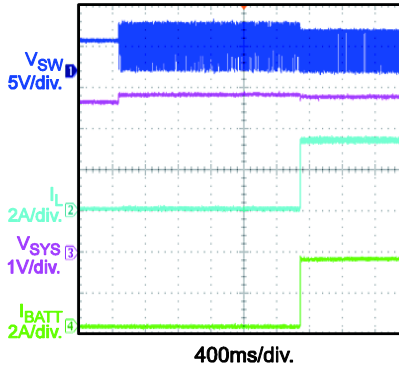

OTG Mode Start-Up
 $V_{IN_OTG}=5V$, $V_{BATT_OTG}=3.6V$, $I_{OTG}=1.3A$

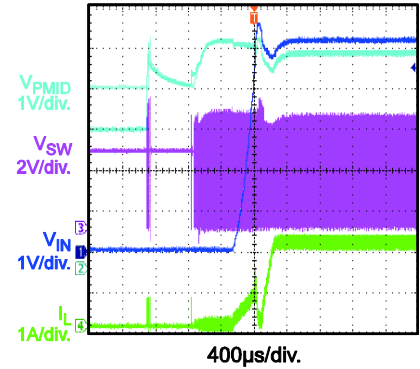

OTG Mode Shutdown
 $V_{IN_OTG}=5V$, $V_{BATT_OTG}=3.6V$, $I_{OTG}=1.3A$

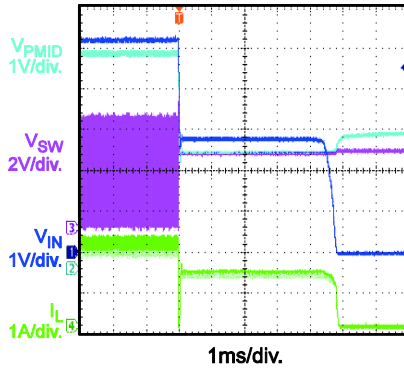

Battery Discharge Current
 $V_{IN}=\text{Float}$, $I_{SYS}=9A$, $V_{BATT}=4.0V$

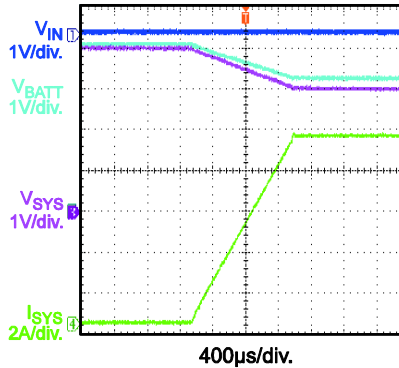

DISC Function
 $V_{IN}=\text{Float}$, $I_{SYS}=1A$, $V_{BATT}=4.2V$

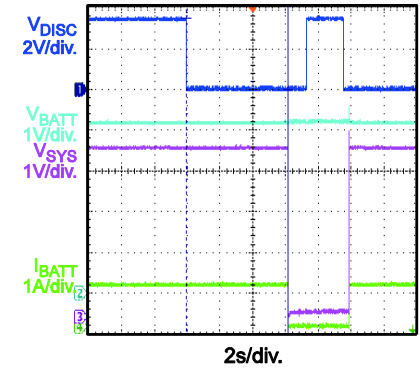

NTC Function
 $V_{IN}=5V$, $V_{BATT}=3.8V$, $I_{CHG}=2A$

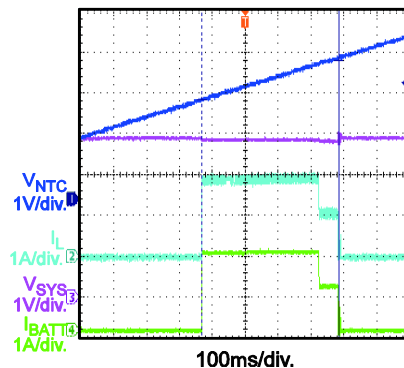

NTC Function
 $V_{IN}=5V$, $V_{BATT}=3.8V$, $I_{CHG}=2A$

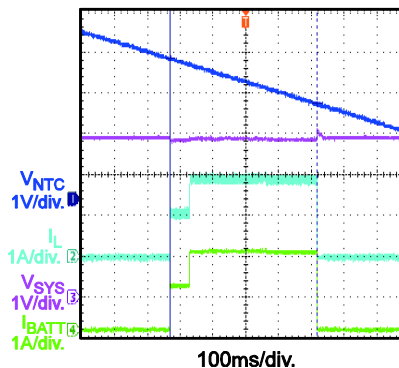

PRINTED CIRCUIT BOARD LAYOUT

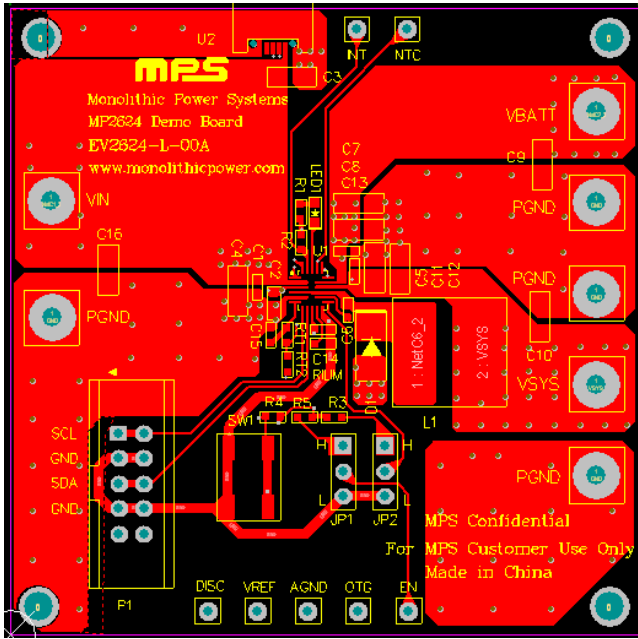

Figure 1—Top Layer

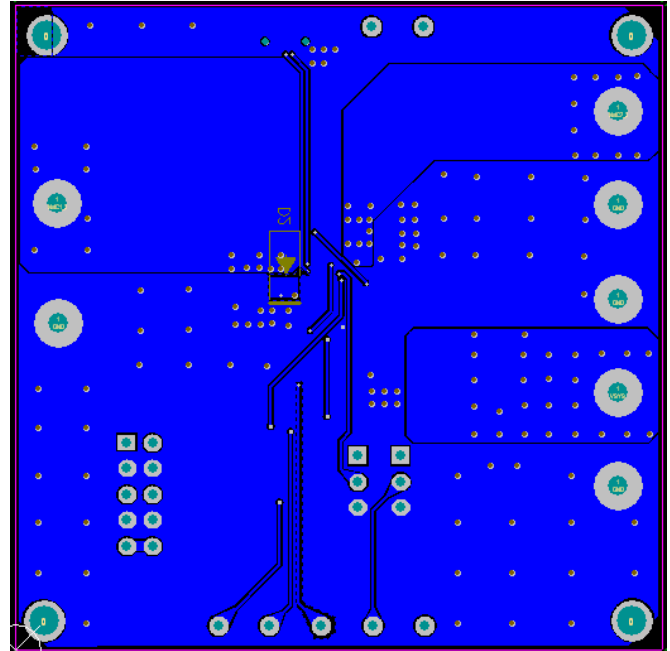

Figure 2—Bottom Layer

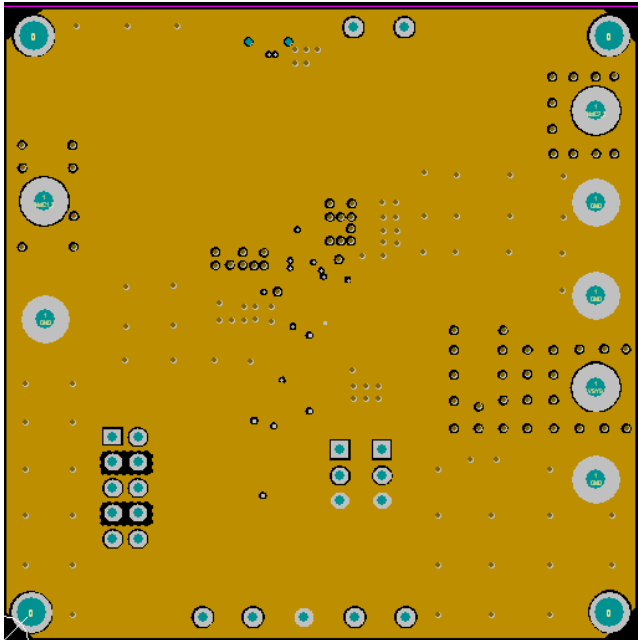

Figure 3—Middle Layer1

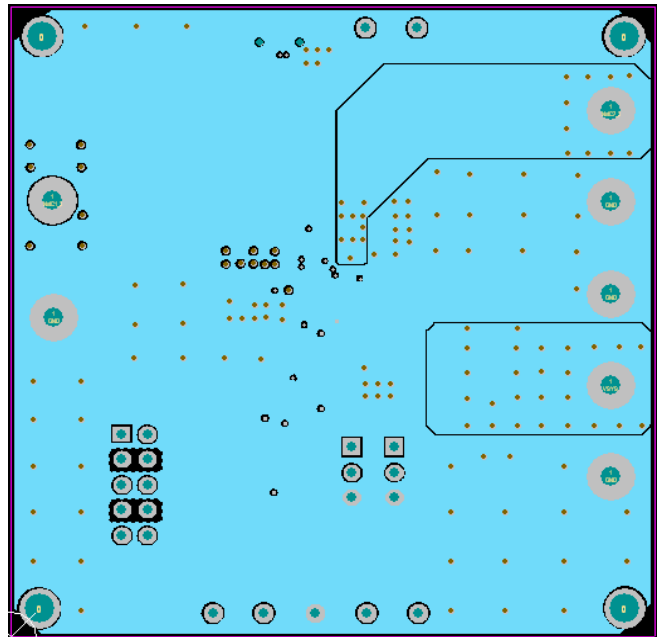

Figure 4—Middle Layer2

QUICK START GUIDE

Table 1. Jumper Connections

Jack	Description	Factory Setting
JP2	OTG pin setting: pull low to enable the OTG	Pull high
JP1	EN pin setting: pull low to enable the charge	Pull Low
P1	I2C connector	

This board is designed for MP2624 used as a standalone switching charger with integrated USB detection and USB-OTG function, and layout accommodates most commonly used capacitors. The default function of this board is preset for charger mode and the charge full voltage is preset to 4.2V for 1 cell Li-Ion battery.

Evaluation Platform Preparation:

1) USB-to-GPIO Communication Kit

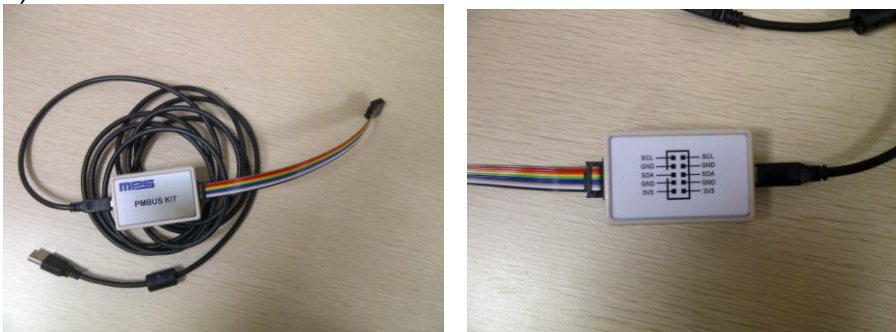

2) Software - double-click on the MP2624.EXE file and open the software. The software supports the Windows® XP operating systems.



MP2624_R1.2.exe

3) A computer with at least one USB port and a USB cable. The MP2624 evaluation software must be properly installed.

4) Original Test Setup for MP2624 in Figure 1

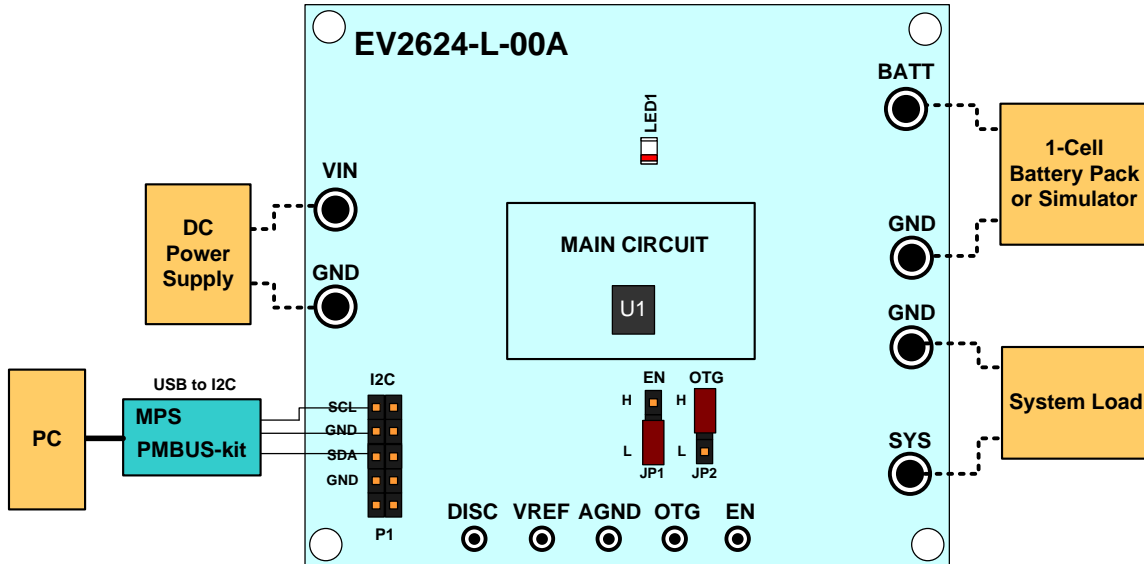
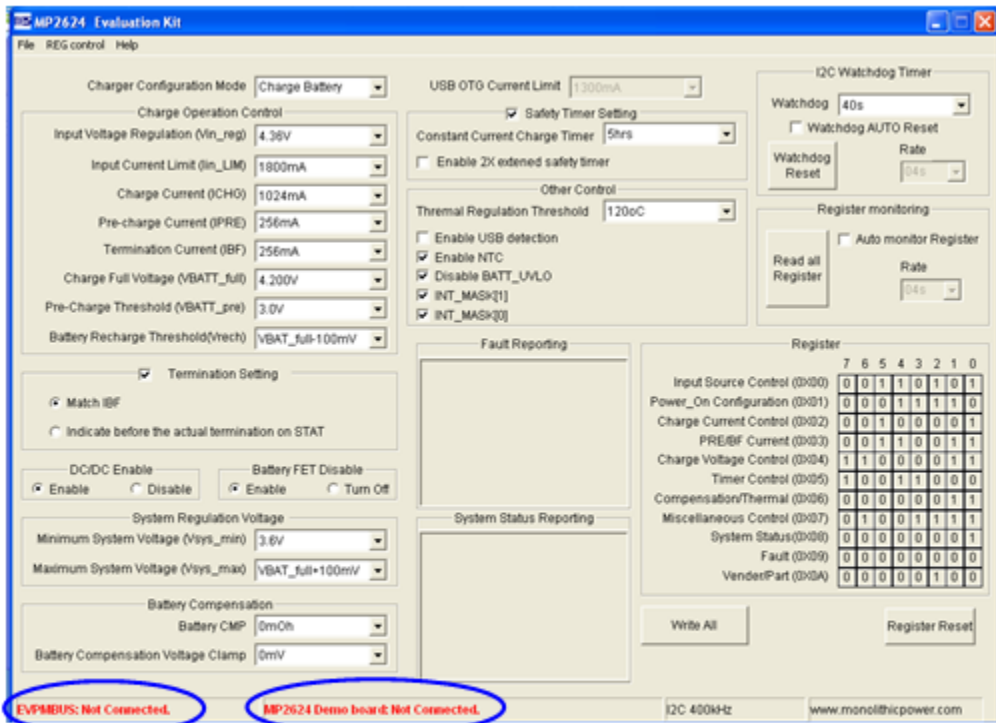

Figure1 Test Setup for MP2624

5) Turn on the computer. Launch the MP2624 evaluation software. The main window of the software is shown in Figure 2.

Figure2 MP2624 evaluation software



Indicate the connection with USB to I2C

Indicate the connection with MP2624 demo

Procedure

Make sure all the connections are normal -- the EVPMBUS connected and MP2624 DEMO board connected. It is ready to run the program!

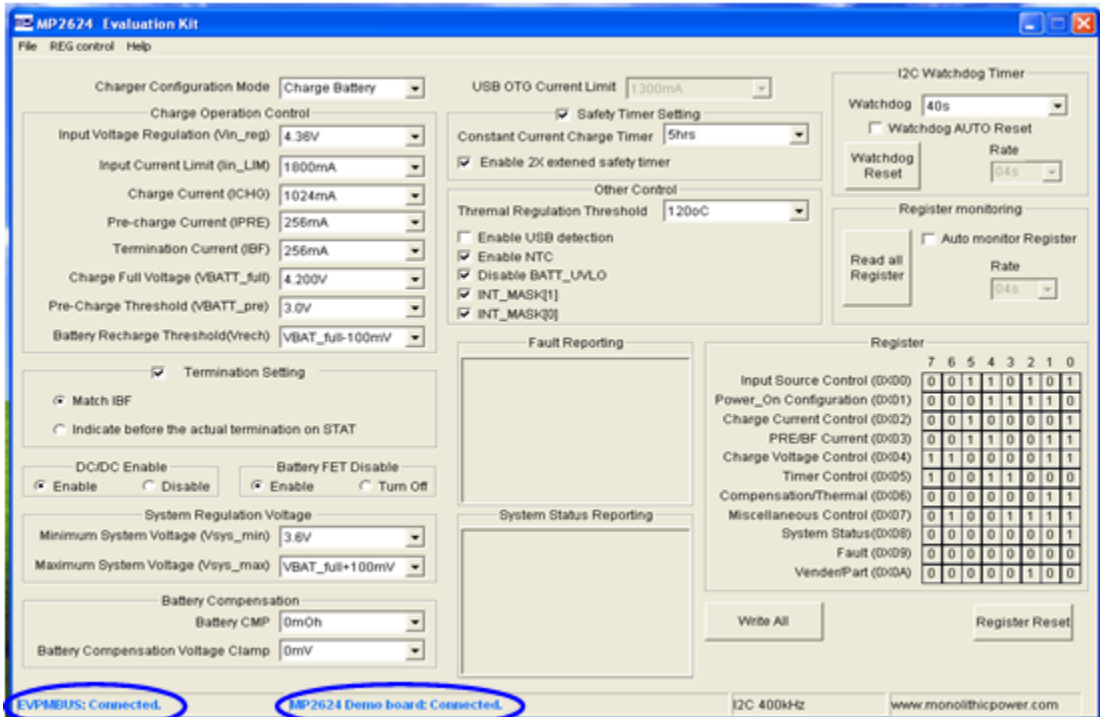

1) Select the operation mode of MP2624:

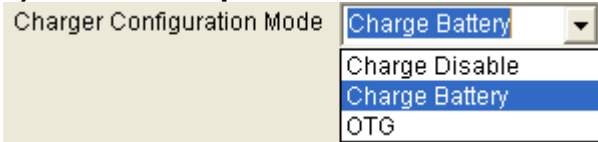

2) Charger Function

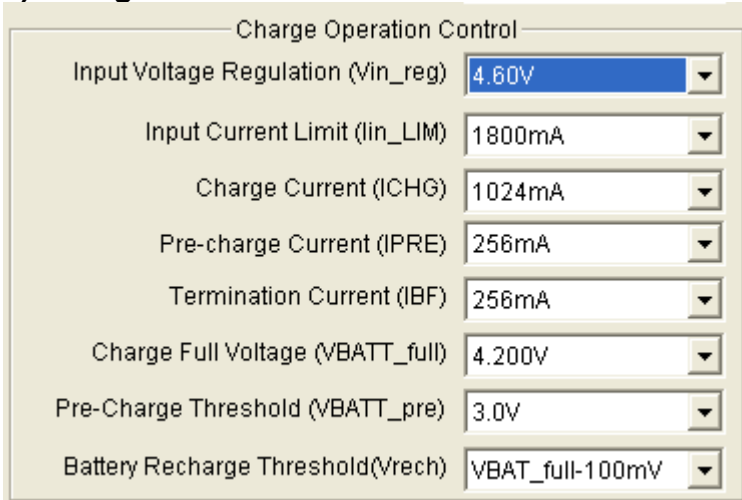

1. Set Input Voltage Regulation at 4.60 V (the range is 3.88 - 5.08V)

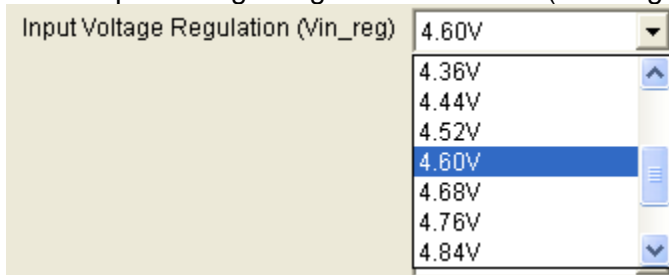

2. Set Input Current Limit to 1800 mA (the range is 100 – 3000mA)

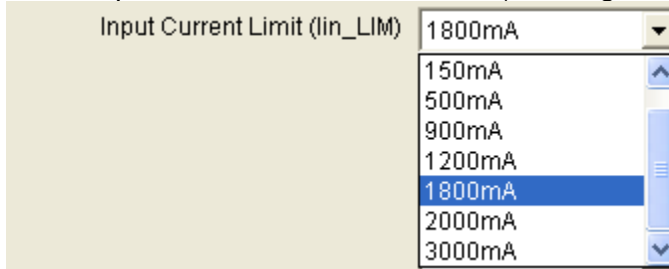

The input current limit can be set to be a little bit lower than the max current rating of the input source. When input current hits the limit the charge current will be decreased to keep the input current constant at this limit, in order to power the system firstly.

3. Set Constant Charge Current, ICHG to 3000 mA (the range is 512 – 4544mA)

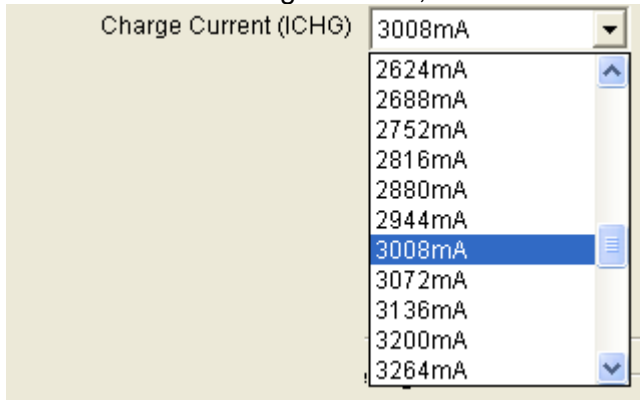

4. Set Pre -Charge Current to 256 mA (the range is 64 – 1024mA)

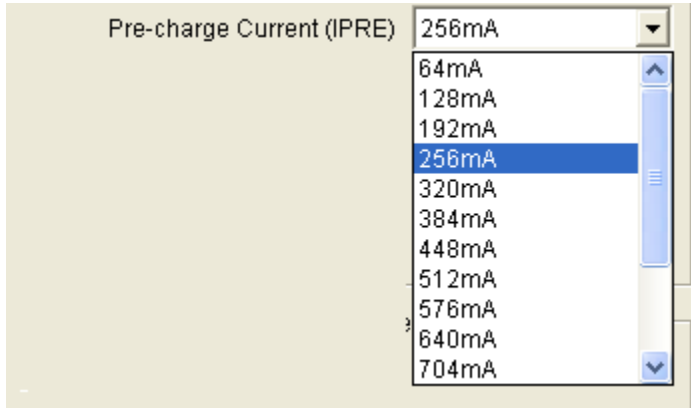

5. Set Terminal Charge Current to 256 mA (the range is 64 – 1024mA)

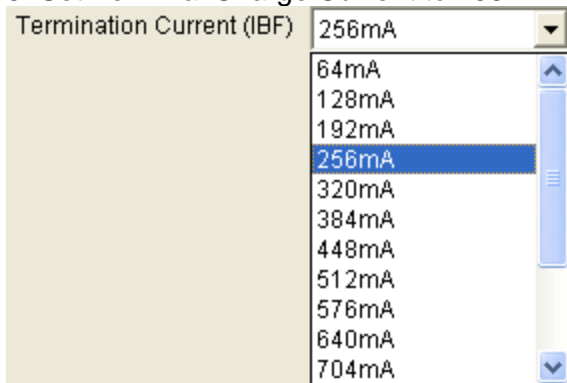

6. Set Charge Full Voltage to 4.208 V (the range is 3.480 - 4.425V)

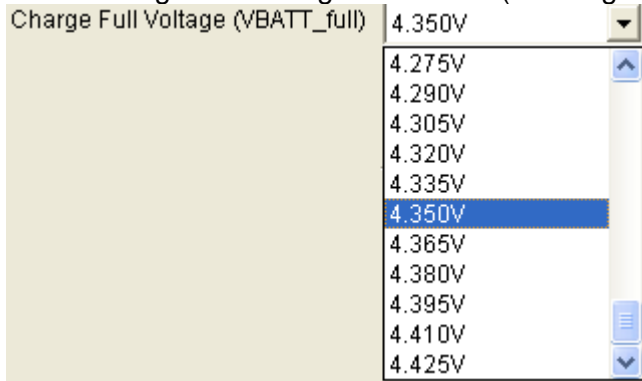

7. Set Pre- Charge to CC Charge Threshold Voltage to 3.0 V (the range is 2.8 – 3.0V)

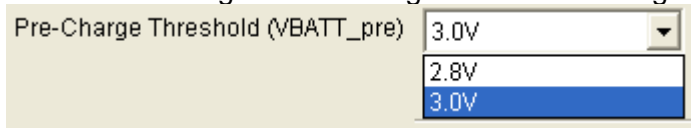

8. Set Battery auto recharge Voltage to VBATT_Full – 200mV (the range is 100mV or 200mV)

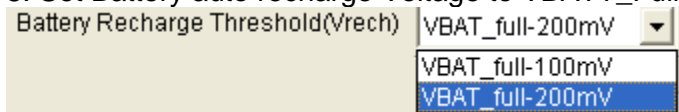

9. Deselect Enable Termination

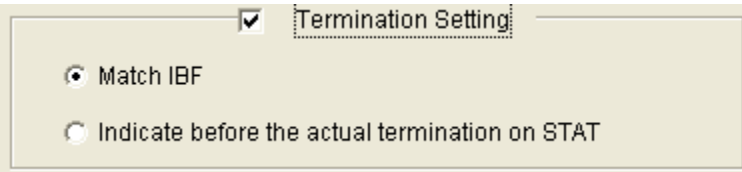

10. Set Charge Timer to 5hrs (the range is 5 – 20hrs)

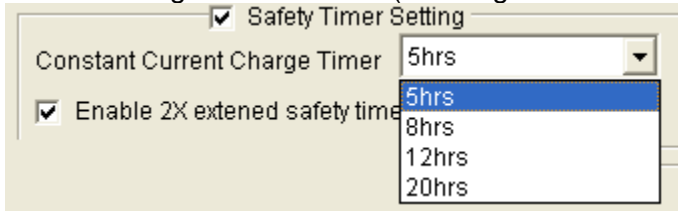

The integrated charge timer provides a back-up protection to prevent a damaged battery from being charged after a certain time. The MP2624 can disable the timer function by deselecting.

3) Boost Function

When the MP2624 is programmed to OTG mode, the output current limit can be controlled via I2C.

1. Turn off and disconnect power at VIN to PGND
2. If the constant voltage load connected from BATT+ to GND is not a four-quadrant supply (sources current) remove the load and use the power source disconnected in step one, set to 3.7 V and 2 A current limit and connect between BATT+ and PGND
3. Apply Resistor (5 W or greater, R=3 to 10ohm) across VIN(+) to PGND(-)
4. Select OTG in the Configuration drop-down window

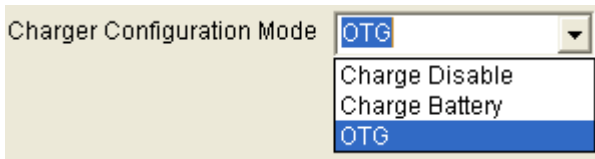

5. Verify the voltage on VIN to GND is between 4.9 V and 5.3 V
6. The OTG current setting is unlocked after choosing the OTG mode. The default OTG current is 1300mA.

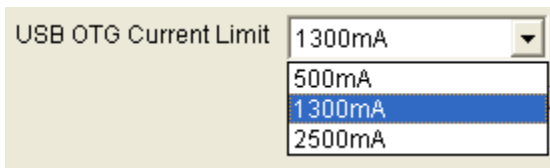

Others

1. Charge Battery Control:

Battery FET Disable

Enable Turn Off

2. DC/DC Enable Control:

DC/DC Enable

Enable Disable

3. Adjust System Voltage in the charge mode

System Regulation Voltage

Minimum System Voltage (Vsys_min) 3.5V

Maximum System Voltage (Vsys_max) VBAT_full+100mV

4. Battery Voltage Compensation in charge mode:

Battery Compensation

Battery CMP 0mOh

Battery Compensation Voltage Clamp 0mV

5. Select I2C Watchdog Timer Limit: click "Watchdog AUTO Reset" to run the program automatically.

I2C Watchdog Timer

Watchdog 40s

Watchdog AUTO Reset

Watchdog Rate 04s

Watchdog Reset

I2C Watchdog Timer

Watchdog 40s

Watchdog AUTO Reset

Watchdog Rate 04s

Watchdog Reset

6. Other Control: include the thermal regulation threshold, USB detection, NTC monitor, UVLO control, indication setting.

Other Control

Thermal Regulation Threshold 120oC

Enable USB detection

Enable NTC

Disable BATT_UVLO

INT_MASK[1]

INT_MASK[0]

7. Resistor Auto Monitor

Register monitoring

Auto monitor Register

Read all Register

Rate: 04s

8. Content of the Registers:

Register

	7	6	5	4	3	2	1	0
Input Source Control (0X00)	0	0	1	1	0	1	0	1
Power_On Configuration (0X01)	0	0	0	1	1	0	1	1
Charge Current Control (0X02)	0	0	1	0	0	0	0	1
PRE/BF Current (0X03)	0	0	1	1	0	0	1	1
Charge Voltage Control (0X04)	1	1	0	0	0	0	1	1
Timer Control (0X05)	1	0	0	1	1	0	0	0
Compensation/Thermal (0X06)	0	0	0	0	0	0	1	1
Miscellaneous Control (0X07)	0	1	0	0	1	0	1	1
System Status(0X08)	0	0	0	0	0	0	0	1
Fault (0X09)	0	0	0	0	0	0	0	0
Vender/Part (0X0A)	0	0	0	0	0	1	0	0

Write All Register Reset

9. Monitor the MP2624 operation status and Fault report

Fault Reporting

System Satus Reporting

❖Notes❖

- For the other detailed description on the operation of this part, please contact local FAE to apply the latest datasheet.

NOTICE: The information in this document is subject to change without notice. Please contact MPS for current specifications. Users should warrant and guarantee that third party Intellectual Property rights are not infringed upon when integrating MPS products into any application. MPS will not assume any legal responsibility for any said applications.

Mouser Electronics

Authorized Distributor

Click to View Pricing, Inventory, Delivery & Lifecycle Information:

[Monolithic Power Systems \(MPS\):](#)

[EV2624-L-01A](#)