

PART NUMBER	ENGINEERING NUMBER	FINISH LENGTH
1300660188	CR4C00A30M003	0.98' [0.3M]
1300660189	CR4C00A30M005	1.64' [0.5M]
1300660190	CR4C00A30M010	3.28' [1.0M]

PART NUMBER LEGEND

CR4C00A30M003

LENGTH
M005 = 0.5 METER
M010 = 1 METER
M100 = 10 METER

CABLE LENGTH TOLERANCES

>.3M [1FT]:	+19mm-0 [+.75in-0]
.3 - .9M [1 - 3FT]:	+44.5mm-0 [+1.75in-0]
.9 - 1.8M [3 - 6FT]:	+55.6mm-0 [+2.19in-0]
1.8 - 3.7M [6 - 12FT]:	+88.9mm-0 [+3.50in-0]
3.7 - 7.3M [12 - 24FT]:	+165.1mm-0 [+6.50in-0]
7.3-14.6M [24 - 48FT]:	+317.5mm-0 [+12.50in-0]
14.6 - 30.5M [48-100FT]:	+622.3mm-0 [+24.50in-0]
OVER 30M [100FT]	+2% OF FINISHED LENGTH

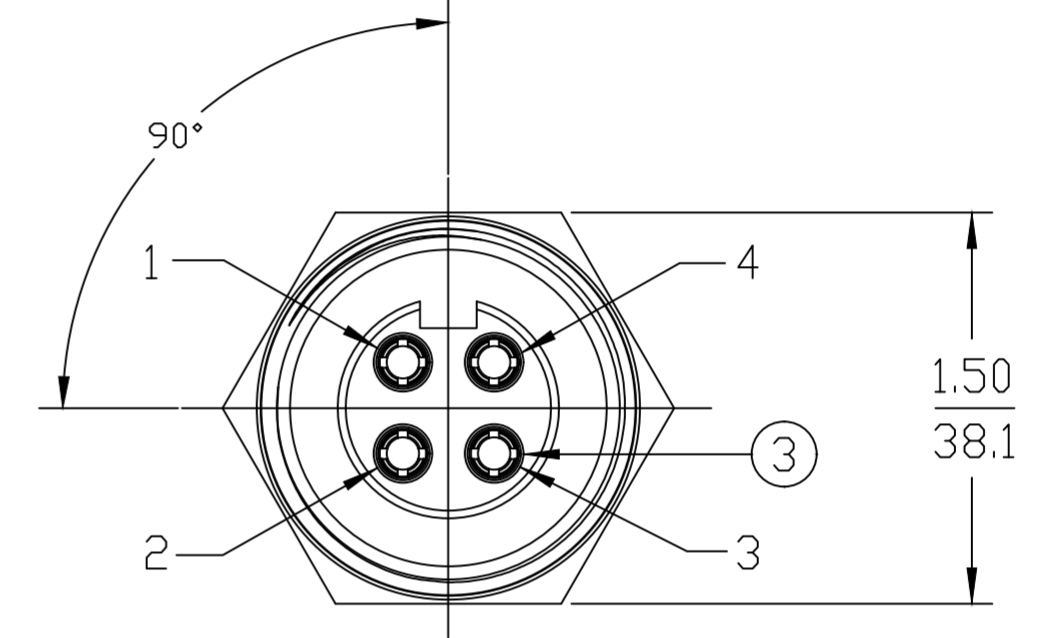
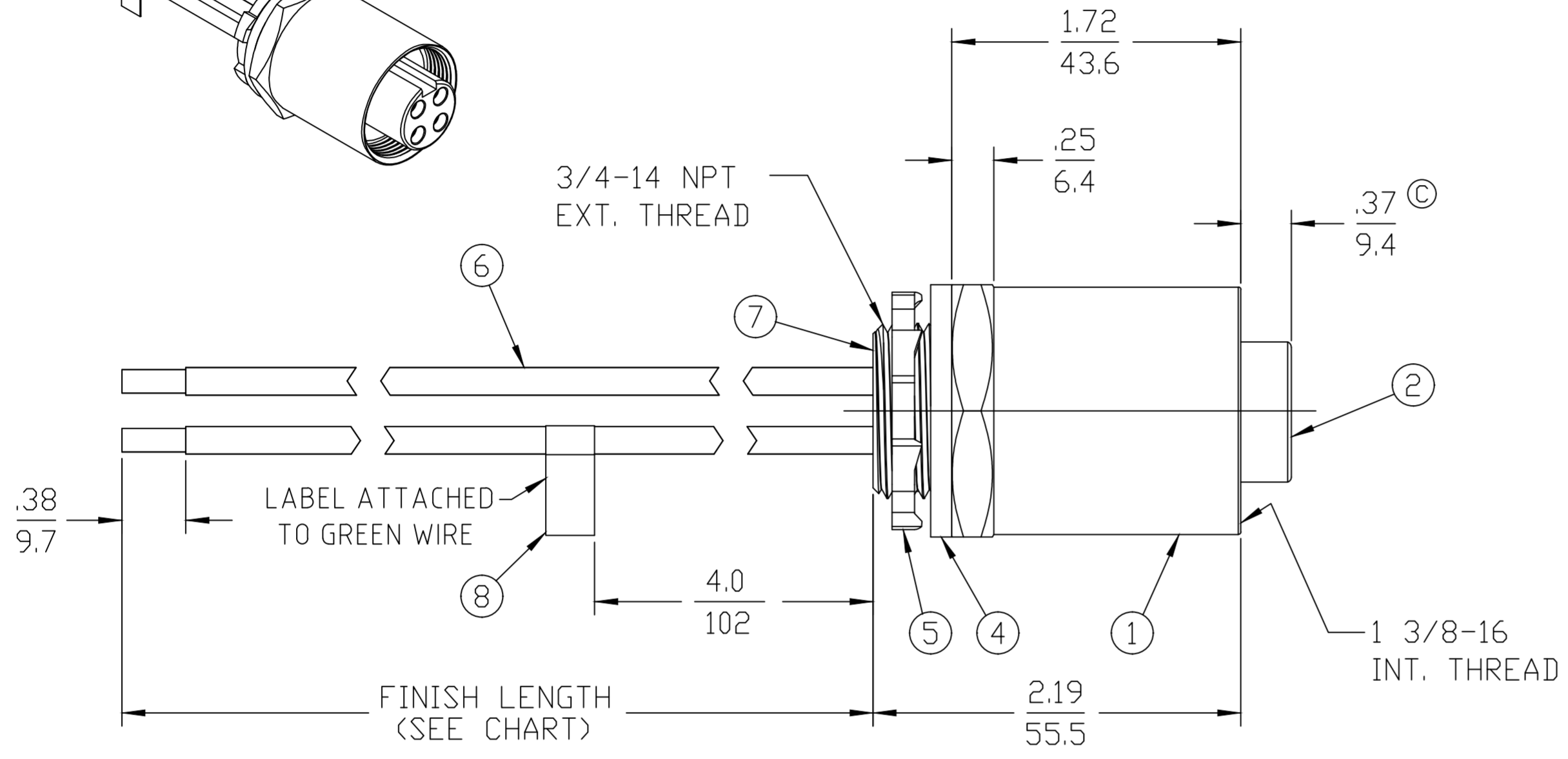
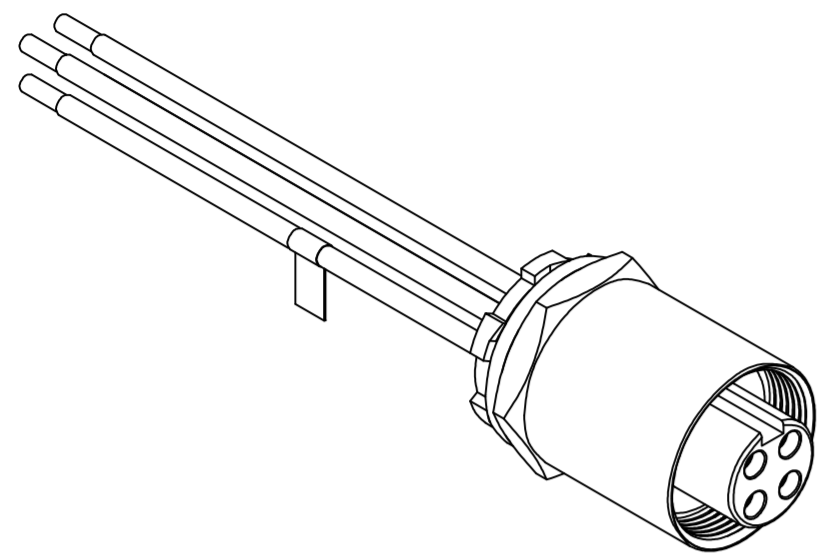

- NOTES:**
- MATERIAL: AS NOTED
 - FINISH: AS NOTED
 - ELECTRICAL:
VOLTAGE: 4P: 500V PER IEC60664
600V PER UL2237
CURRENT: 32A
 - TEMP RATING: -20°TO +90°C
 - PROTECTION: IP67 (WHEN MATED)
 - UL LISTED FILE: E258922
 - ALL DIMS ARE FOR REFERENCE UNLESS NOTED OR DIMENSIONED OTHERWISE

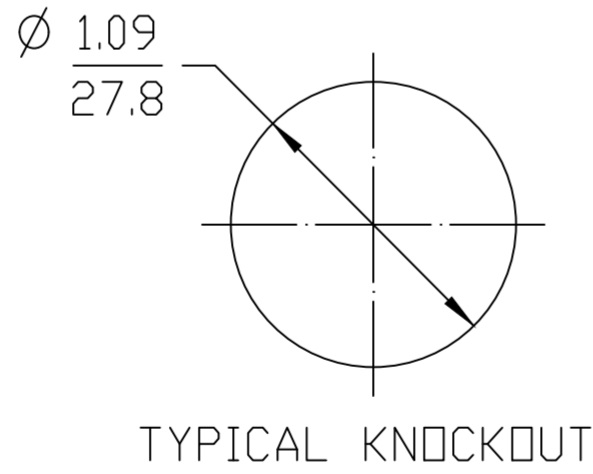

BLACK	1
© GREEN/YELLOW	2
RED	3
WHITE	4

WIRING DIAGRAM

ITEM	DESCRIPTION	MATERIAL	FINISH
8	FLAG LABEL	VINYL	YELLOW
7	POTTING	EPOXY	BLACK
6	WIRE, 10 AWG UL 1015	PVC JACKET	SEE WIRING DIAGRAM
5	LOCKNUT	STEEL	ZINC PLATED
4	GASKET	NEOPRENE	BLACK
3	SOCKET CONTACT	COPPER ALLOY	GOLD PLATED
2	FEMALE INSERT, 4 POLE	TPE ©	BLACK
1	RECEPTACLE SHELL	ALUMINUM	CLEAR ANODIZED

REF. THIS DRAWING SUPERSEDES COCREATE REV. A

SYMBOLS		THIS DRAWING CONTAINS INFORMATION THAT IS PROPRIETARY TO MOLEX ELECTRONIC TECHNOLOGIES, LLC AND SHOULD NOT BE USED WITHOUT WRITTEN PERMISSION	
▽ = 0	DIMENSION UNITS	SCALE	CURRENT REV DESC: INSERT WAS PVC, CORRECTED .37 DIM, WAS .30, ADD GREEN/YELL
▽ = 0	INCH/MM	1:1	
▽ = 0	GENERAL TOLERANCES (UNLESS SPECIFIED)		
▽ = 0		mm	INCH
▽ = 0	4 PLACES	±----	±----
▽ = 0	3 PLACES	±----	±----
▽ = 0	2 PLACES	±0.05	±----
▽ = 0	1 PLACE	±0.1	±----
▽ = 0	0 PLACES	±----	±----
▽ = 0	ANGULAR TOL ± 0.5 °		
▽ = 0	DRAFT WHERE APPLICABLE MUST REMAIN WITHIN DIMENSIONS		
▽ = 0	THIRD ANGLE PROJECTION	DRAWING	SERIES
		C-SIZE	130066
		EC NO: 626034	DRWN: RSTONE 2019/10/18
		CHK'D: MZIELINSKI	2020/01/10
		APPR: BWOODMAN	2020/01/21
		INITIAL REVISION:	
		DRWN: CLYORK	2010/01/18
		APPR: DTITUS	2010/01/20
DOCUMENT NUMBER		DOC TYPE	DOC PART
SD-130066-056		PSD	001
CUSTOMER		SHEET NUMBER	
GENERAL MARKET		1 OF 1	

Mouser Electronics

Authorized Distributor

Click to View Pricing, Inventory, Delivery & Lifecycle Information:

[Molex:](#)

[1300660188](#)