

PLEASE CHECK WWW.MOLEX.COM FOR LATEST PART INFORMATION

Part Number: [0740581116](#)
Status: **Active**
Description: VHDM 6 Row Adv. Mate Signal End BP

Documents:

[Drawing \(PDF\)](#) [RoHS Certificate of Compliance \(PDF\)](#)
[Packaging Specification PK-74058-003 \(PDF\)](#)

Agency Certification

UL E29179

General

Product Family Backplane Connectors
 Series [74058](#)
 UPC 822348858514

Physical

Flammability 94V-0
 Net Weight 8.440/g

Solder Process Data

Lead-freeProcess Capability N/A

Material Info

Reference - Drawing Numbers

Packaging Specification PK-74058-003
 Sales Drawing SD-74058-003

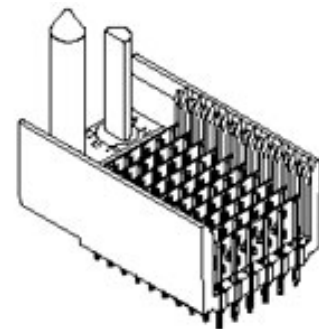

Series image - Reference only

EU ELV

Not Relevant

EU RoHS

Compliant

REACH SVHC

Not Contained Per -
 ED/21/2016 (20 June
 2016)

Halogen-Free

Status

Low-Halogen

**Need more information on product
 environmental compliance?**

Email productcompliance@molex.com
 Please visit the [Contact Us](#) section for any
 non-product compliance questions.

China ROHS
 ELV

Green Image
 Not Relevant

Search Parts in this Series

[74058](#) Series

Application Tooling | [FAQ](#)

*Tooling specifications and manuals are
 found by selecting the products below.
 Crimp Height Specifications are then
 contained in the Application Tooling
 Specification document.*

Global

Description	Product #
Insertion Module for Advanced Mate Signal Header, 6- Row by 10-Wide, 20.00mm	0622020203
Insertion Module for Advanced Mate Signal Header, 6- Row by 10-Wide, 20.00mm	0622020207

Insertion Module 0622011101
for Advanced Mate
Signal Header, 6-
Row by 11-Wide,
20.00mm

This document was generated on 07/11/2016

PLEASE CHECK WWW.MOLEX.COM FOR LATEST PART INFORMATION

Mouser Electronics

Authorized Distributor

Click to View Pricing, Inventory, Delivery & Lifecycle Information:

[Molex:](#)

[74058-1116](#)