

## High Performance Dual 150 mA LDOs

### Features

- 6-Lead 1 mm x 1 mm FTQFN Package
- 2.5V to 5.5V Input Voltage Range
- 150 mA Output Current per LDO
- High Output Accuracy  $\pm 1\%$  Typical
- Low Quiescent Current of 32  $\mu\text{A}$  per LDO
- Stable with 0402 1  $\mu\text{F}$  Ceramic Output Capacitors
- Low Dropout Voltage 155 mV at 150 mA
- Output Discharge Circuit on MIC5381
- Independent Enable Pins
- Thermal Shutdown Protection
- Current Limit Protection

### Applications

- Bluetooth Headsets
- Mobile Phones
- GPS, PMP, PDAs, DSCs
- USB Thumb Drive
- Medical Handheld
- Portable Handheld Electronics

### General Description

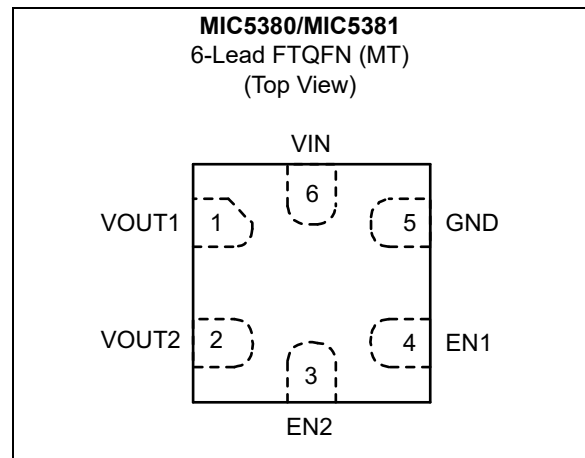
The MIC5380 and MIC5381 are advanced dual LDOs that are ideal for powering space-constrained portable devices. The MIC5380/1 provide two independently controlled, high performance 150 mA LDOs in an ultra-small 1 mm x 1 mm FTQFN package.

Ideal for battery powered applications, the MIC5380/1 offer  $\pm 1\%$  typical accuracy, low dropout voltage (155 mV at 150 mA), and low ground current. The MIC5380/1 can also be put into a zero-off-mode current state, drawing virtually no current when disabled.

The MIC5380/1 offer fast transient response and high PSRR while consuming minimal operating current. When the MIC5381 is disabled, an internal resistive load is automatically applied to the output to discharge the output capacitor.

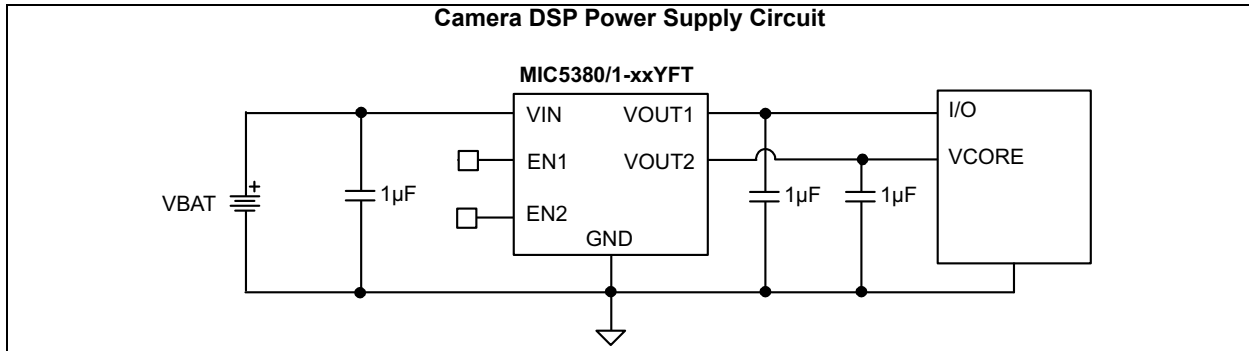
The MIC5380/1 are available with fixed output voltages in a lead-free (RoHS compliant) 6-lead 1 mm x 1 mm FTQFN package.

### Package Type

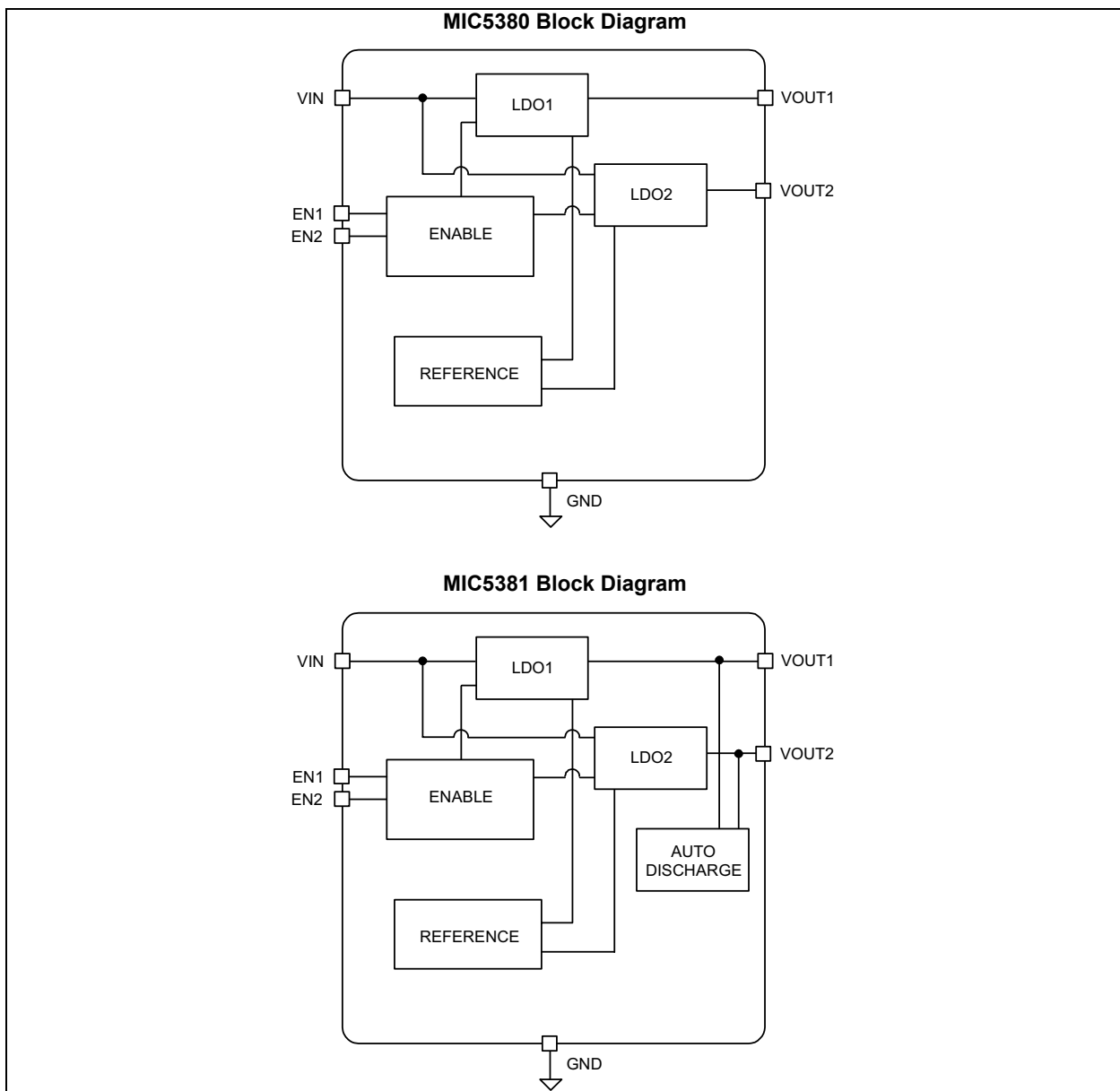


# MIC5380/1

## Typical Application Circuit



## Functional Block Diagrams



## 1.0 ELECTRICAL CHARACTERISTICS

### Absolute Maximum Ratings †

Supply Voltage ( $V_{IN}$ )	.....	-0.3V to +6V
Enable Voltage ( $V_{EN1}$ , $V_{EN2}$ )	.....	-0.3V to $V_{IN}$
Power Dissipation ( $P_D$ ) (Note 1)	.....	Internally Limited
ESD Rating (Note 2)	.....	2 kV

### Operating Ratings ††

Supply Voltage ( $V_{IN}$ )	.....	+2.5V to +5.5V
Enable Voltage ( $V_{EN1}$ , $V_{EN2}$ )	.....	-0.3V to $V_{IN}$

† **Notice:** Stresses above those listed under “Absolute Maximum Ratings” may cause permanent damage to the device. This is a stress rating only and functional operation of the device at those or any other conditions above those indicated in the operational sections of this specification is not intended. Exposure to maximum rating conditions for extended periods may affect device reliability.

†† **Notice:** The device is not guaranteed to function outside its operating ratings.

**Note 1:** The maximum allowable power dissipation of any  $T_A$  (ambient temperature) is  $P_{D(MAX)} = (T_{J(MAX)} - T_A)/\theta_{JA}$ . Exceeding the maximum allowable power dissipation will result in excessive die temperature, and the regulator will go into thermal shutdown.

**2:** Devices are ESD sensitive. Handling precautions recommended. Human body model, 1.5 k $\Omega$  in series with 100 pF.

## ELECTRICAL CHARACTERISTICS

**Electrical Characteristics:**  $V_{IN} = V_{EN1} = V_{EN2} = V_{OUT} + 1V$ ; higher of the two regulator outputs;  $I_{OUTLDO1} = I_{OUTLDO2} = 100 \mu A$ ;  $C_{OUT1} = C_{OUT2} = 1 \mu F$ ;  $T_J = +25^\circ C$ , **bold** values valid for  $-40^\circ C$  to  $+125^\circ C$ , unless noted. [Note 1](#)

Parameter	Symbol	Min.	Typ.	Max.	Units	Conditions
Output Voltage Accuracy	—	—	$\pm 1$	—	%	Variation from nominal $V_{OUT}$
		<b>-3.0</b>	—	<b>3.0</b>	%	Variation from nominal $V_{OUT}$ ; $-40^\circ C$ to $+85^\circ C$
Line Regulation	$\frac{\Delta V_{OUT}}{(V_{OUT} \times \Delta V_{IN})}$	—	0.02	<b>0.3</b>	%/V	$V_{IN} = V_{OUT} + 1V$ to 5.5V, $I_{OUT} = 100 \mu A$
Load Regulation	$\frac{\Delta V_{OUT}}{V_{OUT}}$	—	0.3	1	%	$I_{OUT} = 100 \mu A$ to 150 mA
Dropout Voltage	$V_{DROP}$	—	55	<b>110</b>	mV	$I_{OUT} = 50$ mA
		—	155	<b>310</b>	mV	$I_{OUT} = 150$ mA
Ground Pin Current	$I_{GND}$	—	32	<b>45</b>	$\mu A$	$V_{EN1} = \text{High}$ ; $V_{EN2} = \text{Low}$ ; $I_{OUT} = 0$ mA
		—	32	<b>45</b>	$\mu A$	$V_{EN1} = \text{Low}$ ; $V_{EN2} = \text{High}$ ; $I_{OUT} = 0$ mA
		—	59	<b>85</b>	$\mu A$	$V_{EN1} = V_{EN2} = \text{High}$ ; $I_{OUT1} = I_{OUT2} = 0$ mA
Ground Pin Current in Shutdown	$I_{SHDN}$	—	0.05	1	$\mu A$	$V_{EN1} = V_{EN2} = 0V$
Ripple Rejection	PSRR	—	60	—	dB	$f = 1$ kHz; $C_{OUT} = 1 \mu F$
Current Limit	$I_{LIMIT}$	200	325	550	mA	$V_{OUT} = 0V$
Output Voltage Noise	$e_N$	—	200	—	$\mu V_{RMS}$	$C_{OUT} = 1 \mu F$ , 10 Hz to 100 kHz

**Note 1:** Specification for packaged product only.

# MIC5380/1

## ELECTRICAL CHARACTERISTICS (CONTINUED)

**Electrical Characteristics:**  $V_{IN} = V_{EN1} = V_{EN2} = V_{OUT} + 1V$ ; higher of the two regulator outputs;  $I_{OUTLDO1} = I_{OUTLDO2} = 100 \mu A$ ;  $C_{OUT1} = C_{OUT2} = 1 \mu F$ ;  $T_J = +25^\circ C$ , **bold** values valid for  $-40^\circ C$  to  $+125^\circ C$ , unless noted. [Note 1](#)

Parameter	Symbol	Min.	Typ.	Max.	Units	Conditions
Auto-Discharge NFET Resistance	$R_{DS}$	—	30	—	$\Omega$	MIC5381 Only; $V_{EN1} = V_{EN2} = 0V$ ; $V_{IN} = 3.6V$
<b>Enable Inputs (EN1/EN2)</b>						
Enable Input Voltage	$V_{EN}$	—	—	<b>0.2</b>	V	Logic Low
		<b>1.2</b>	—	—	V	Logic High
Enable Input Current	$I_{EN}$	—	0.01	<b>1</b>	$\mu A$	$V_{IL} \leq 0.2V$
		—	0.01	<b>1</b>	$\mu A$	$V_{IH} \geq 1.2V$
Turn-On Time	$t_{ON}$	—	50	<b>125</b>	$\mu s$	$C_{OUT} = 1 \mu F$

**Note 1:** Specification for packaged product only.

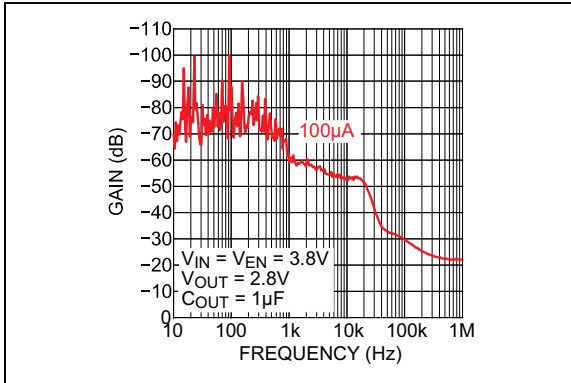
## TEMPERATURE SPECIFICATIONS

Parameters	Sym.	Min.	Typ.	Max.	Units	Conditions
<b>Temperature Ranges</b>						
Junction Temperature Range	$T_J$	-40	—	+125	$^\circ C$	—
Storage Temperature Range	$T_S$	-65	—	+150	$^\circ C$	—
Lead Temperature	—	—	—	+260	$^\circ C$	Soldering, 10 sec.
<b>Package Thermal Resistances</b>						
Thermal Resistance, FTQFN 6-Ld	$\theta_{JA}$	—	150	—	$^\circ C/W$	—

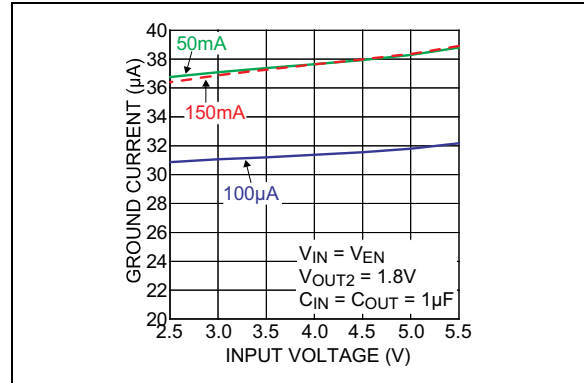
**Note 1:** The maximum allowable power dissipation is a function of ambient temperature, the maximum allowable junction temperature and the thermal resistance from junction to air (i.e.,  $T_A$ ,  $T_J$ ,  $\theta_{JA}$ ). Exceeding the maximum allowable power dissipation will cause the device operating junction temperature to exceed the maximum  $+125^\circ C$  rating. Sustained junction temperatures above  $+125^\circ C$  can impact the device reliability.

## 2.0 TYPICAL PERFORMANCE CURVES

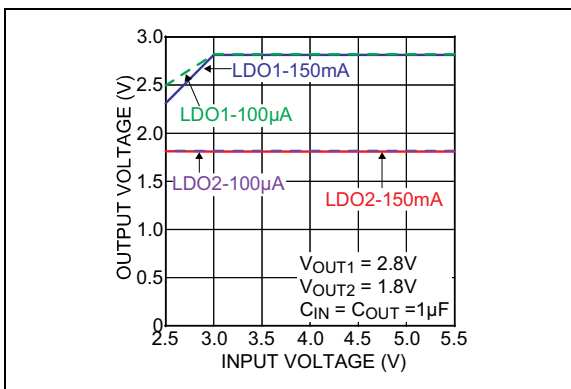
**Note:** The graphs and tables provided following this note are a statistical summary based on a limited number of samples and are provided for informational purposes only. The performance characteristics listed herein are not tested or guaranteed. In some graphs or tables, the data presented may be outside the specified operating range (e.g., outside specified power supply range) and therefore outside the warranted range.



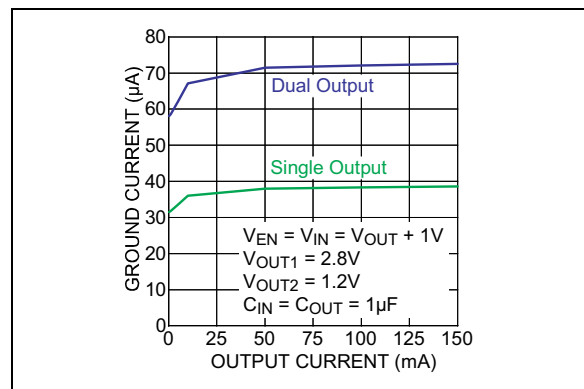
**FIGURE 2-1:** Power Supply Rejection Ratio.



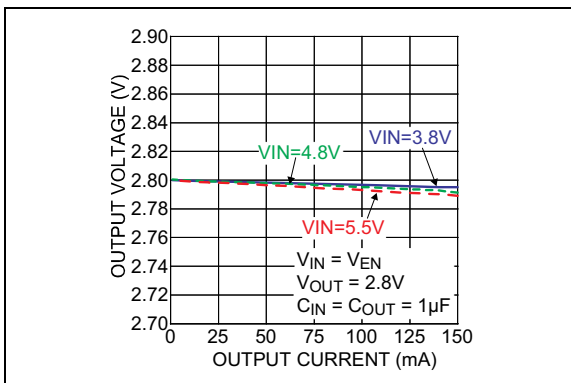
**FIGURE 2-4:** Ground Current vs. Input Voltage.



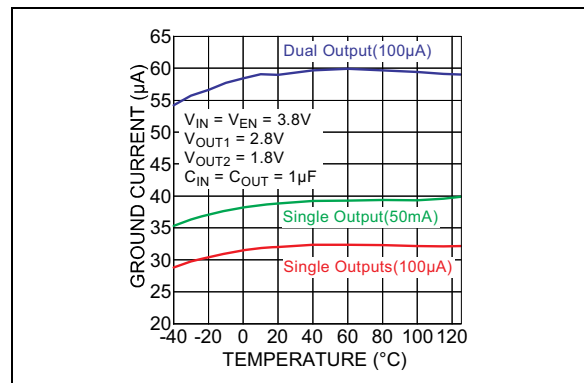
**FIGURE 2-2:** Output Voltage vs. Input Voltage.



**FIGURE 2-5:** Ground Current vs. Output Current.

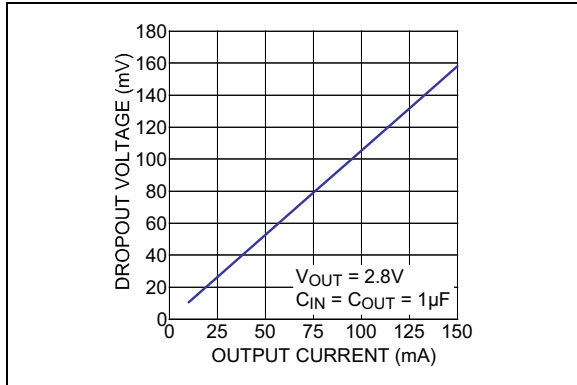


**FIGURE 2-3:** Output Voltage vs. Output Current.

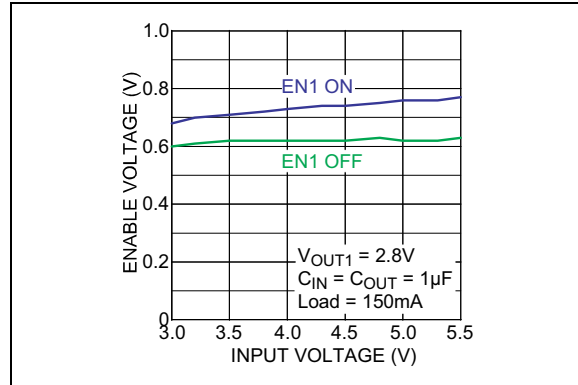


**FIGURE 2-6:** Ground Current vs. Temperature.

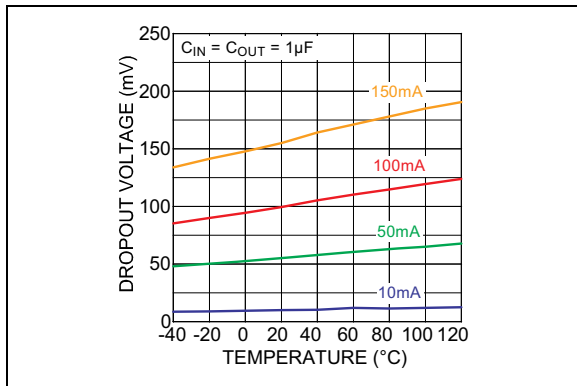
# MIC5380/1



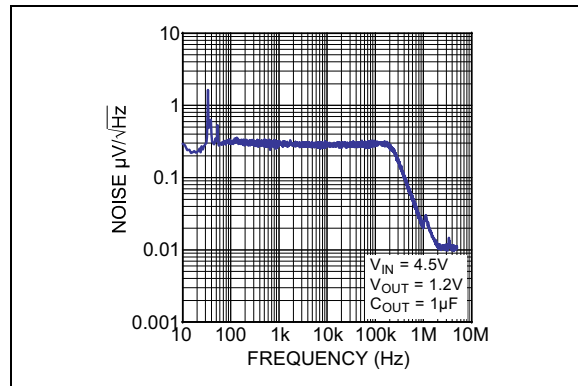
**FIGURE 2-7:** Dropout Voltage vs. Output Current.



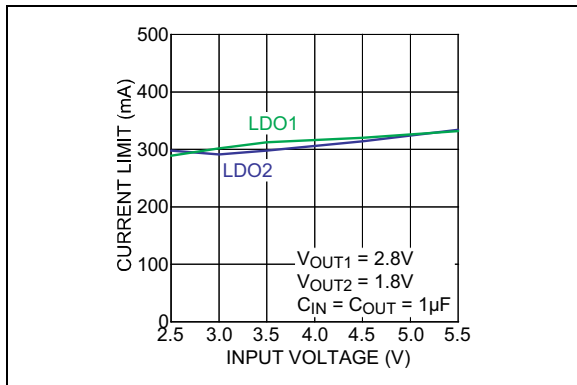
**FIGURE 2-10:** Enable Voltage vs. Input Voltage.



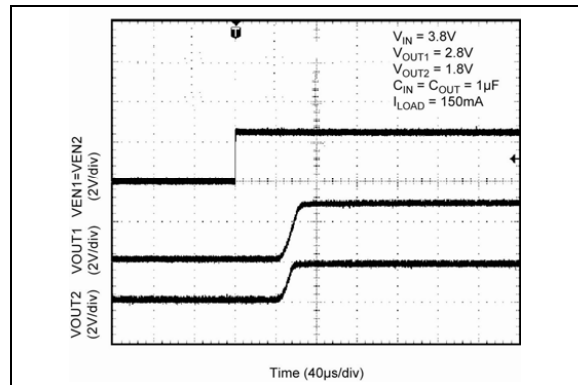
**FIGURE 2-8:** Dropout Voltage vs. Temperature.



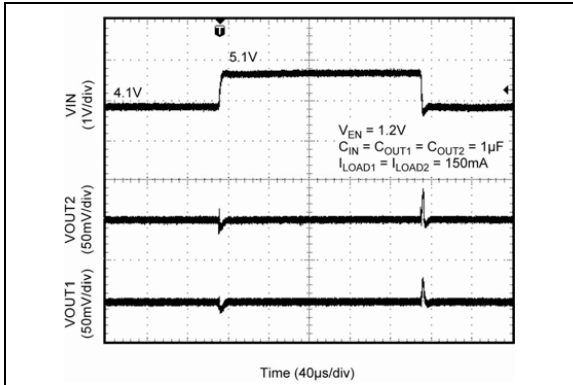
**FIGURE 2-11:** Output Noise Spectral Density.



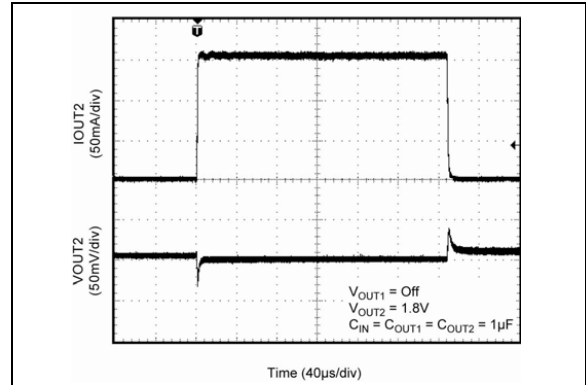
**FIGURE 2-9:** Current Limit vs. Input Voltage.



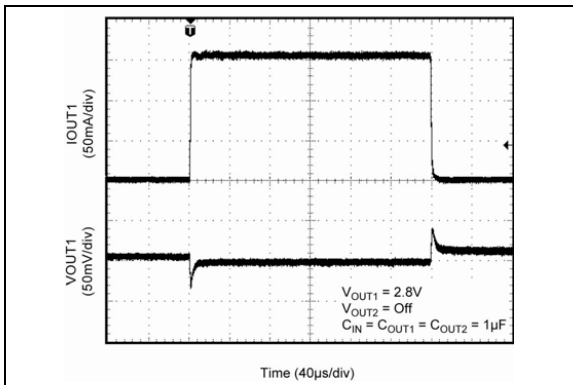
**FIGURE 2-12:** Turn-On Time.



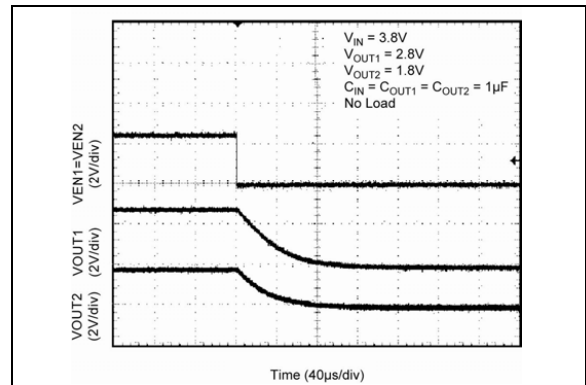
**FIGURE 2-13:** Line Transient.



**FIGURE 2-15:** Load Transient.



**FIGURE 2-14:** Load Transient.



**FIGURE 2-16:** Turn-Off Time MIC5381 (Auto-Discharge).

# MIC5380/1

---

## 3.0 PIN DESCRIPTIONS

The descriptions of the pins are listed in [Table 3-1](#).

**TABLE 3-1: PIN FUNCTION TABLE**

Pin Number	Pin Name	Description
1	VOUT1	Regulator Output – LDO1.
2	VOUT2	Regulator Output – LDO2.
3	EN2	Enable Input (regulator 2). Active-High Input. Logic High = On; Logic Low = Off; Do not leave floating.
4	EN1	Enable Input (regulator 1). Active-High Input. Logic High = On; Logic Low = Off; Do not leave floating.
5	GND	Ground.
6	VIN	Supply Input.



## 4.0 APPLICATION INFORMATION

MIC5380/1 is a dual 150 mA LDO in a small 1 mm x 1 mm FTQFN package. The MIC5381 includes an auto-discharge circuit for each of the LDO outputs that is activated when the output is disabled. The MIC5380/1 regulator is fully protected from damage due to fault conditions through linear current limiting and thermal shutdown.

### 4.1 Input Capacitor

The MIC5380/1 is a high-performance, high bandwidth device. An input capacitor of 1  $\mu$ F capacitor is required from the input-to-ground to provide stability. Low-ESR ceramic capacitors provide optimal performance at a minimum of space. Additional high-frequency capacitors, such as small-valued NPO dielectric-type capacitors, help filter out high-frequency noise and are good practice in any RF-based circuit. X5R or X7R dielectrics are recommended for the input capacitor. Y5V dielectrics lose most of their capacitance over temperature and are therefore, not recommended.

### 4.2 Output Capacitor

The MIC5380/1 requires an output capacitor of 1  $\mu$ F or greater to maintain stability. The design is optimized for use with low-ESR ceramic chip capacitors. High ESR capacitors may cause high frequency oscillation. The output capacitor can be increased, but performance has been optimized for a 1  $\mu$ F ceramic output capacitor and does not improve significantly with larger capacitance.

X7R/X5R dielectric-type ceramic capacitors are recommended because of their temperature performance. X7R-type capacitors change capacitance by 15% over their operating temperature range and are the most stable type of ceramic capacitors. Z5U and Y5V dielectric capacitors change value by as much as 50% and 60%, respectively, over their operating temperature ranges. To use a ceramic chip capacitor with Y5V dielectric, the value must be much higher than an X7R ceramic capacitor to ensure the same minimum capacitance over the equivalent operating temperature range.

### 4.3 No Load Stability

Unlike many other voltage regulators, the MIC5380/1 will remain stable and in regulation with no load. This is especially important in CMOS RAM keep-alive applications.

### 4.4 Enable/Shutdown

The MIC5380/1 comes with two active-high enable pins that allow each regulator to be disabled independently. Forcing the enable pin low disables the regulator and sends it into a “zero” off-mode-current state. In this state, current consumed by the regulator goes nearly to zero. When disabled the MIC5381 switches a 30 $\Omega$  (typical) load on the regulator output to discharge the external capacitor.

Forcing the enable pin high enables the output voltage. The active-high enable pin uses CMOS technology and the enable pin cannot be left floating; a floating enable pin may cause an indeterminate state on the output.

### 4.5 Thermal Considerations

The MIC5380/1 is designed to provide 150 mA of continuous current for both outputs in a very small package. Maximum ambient operating temperature can be calculated based upon the output current and the voltage drop across the part. For example, if the input voltage is 3.6V, and the output voltage 3.0V for  $V_{OUT1}$ , 3.0V for  $V_{OUT2}$  and output current equals 150 mA, then the actual power dissipation of the regulator circuit can be calculated using the equation:

#### EQUATION 4-1:

$$P_D = (V_{IN} - V_{OUT1})I_{OUT1} + (V_{IN} - V_{OUT2})I_{OUT2} + V_{IN}I_{GND}$$

Because this device is CMOS and the ground current is typically <100  $\mu$ A over the load range, the power dissipation contributed by the ground current is <1% and can be ignored for this calculation.

#### EQUATION 4-2:

$$P_D = (3.6V - 3.0V) \times 150mA + (3.6V - 3.0V) \times 150mA = 0.18W$$

To determine the maximum ambient operating temperature of the package, use the junction-to-ambient thermal resistance of the device and the following basic equation:

# MIC5380/1

---

## EQUATION 4-3:

$$P_{D(MAX)} = \frac{T_{J(MAX)} - T_A}{\theta_{JA}}$$

Where:

$T_{J(MAX)} = 125^{\circ}\text{C}$

$\theta_{JA} = \text{Thermal resistance of } 150^{\circ}\text{C/W.}$

Substituting  $P_D$  for  $P_{D(MAX)}$  and solving for the ambient operating temperature will give the maximum operating conditions for the regulator circuit. The junction-to-ambient thermal resistance for the minimum footprint is  $150^{\circ}\text{C/W}$ .

The maximum power dissipation must not be exceeded for proper operation.

For example, when operating the MIC5380-PPYFT at an input voltage of 3.6V and 150 mA loads at each output with a minimum footprint layout, the maximum ambient operating temperature  $T_A$  can be determined as follows:

## EQUATION 4-4:

$$0.18\text{ W} = (125^{\circ}\text{C} - T_A) / (150^{\circ}\text{C/W})$$

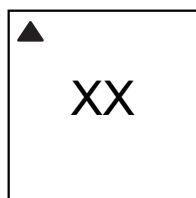
$$T_A = 98^{\circ}\text{C}$$

Therefore, a 3.0V/3.0V application, with 150 mA at each output current, can accept an ambient operating temperature of  $98^{\circ}\text{C}$  in a 1 mm x 1 mm FTQFN package. For a full discussion of heat sinking and thermal effects on voltage regulators, refer to the "Regulator Thermals" section of Microchip's [Designing with Low-Dropout Voltage Regulators handbook](#).

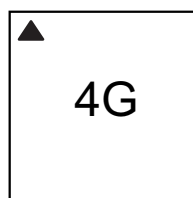
## 5.0 PACKAGING INFORMATION

### 5.1 Package Marking Information

6-Lead FTQFN\*



Example



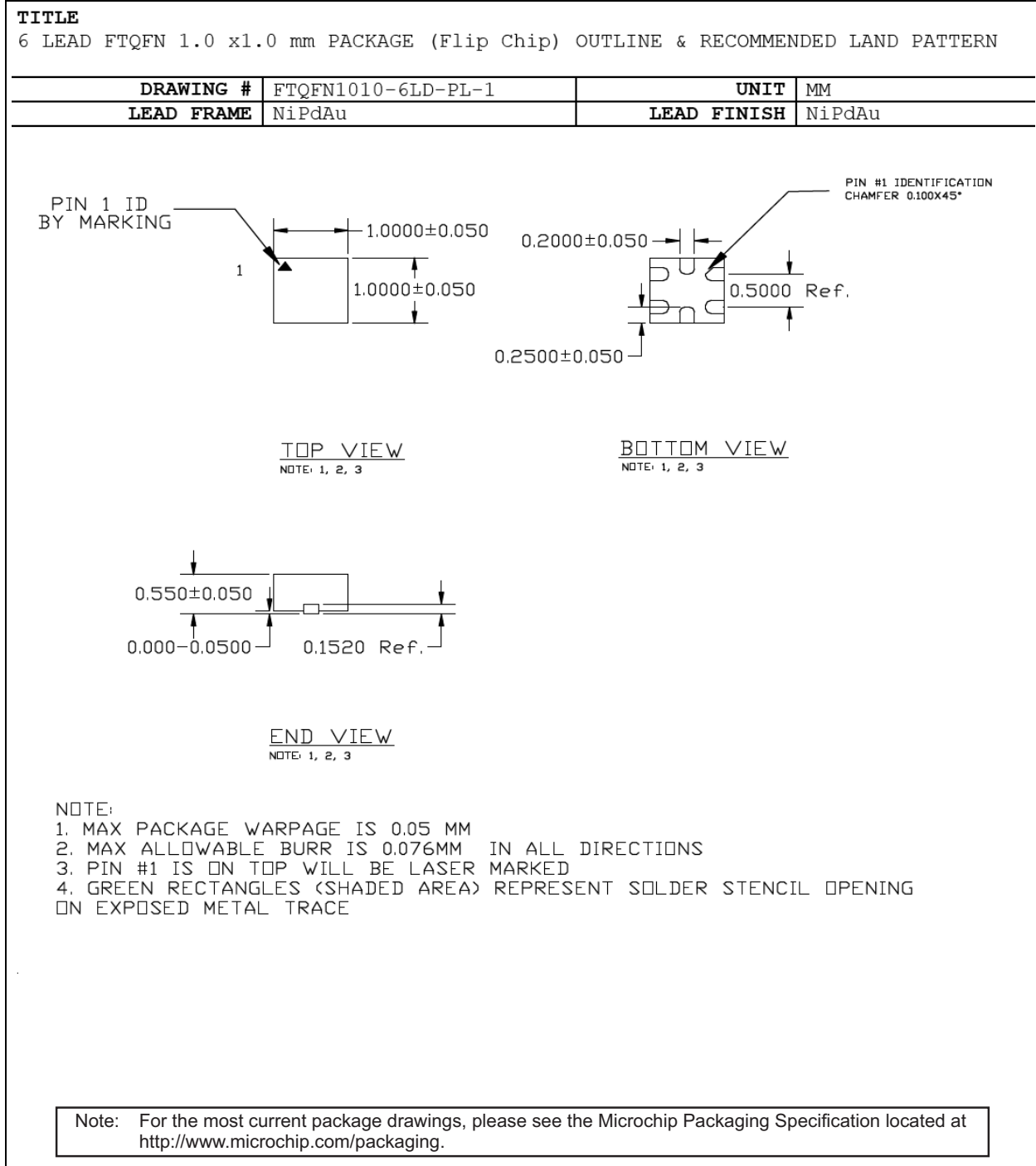
<b>Legend:</b>	XX...X	Product code or customer-specific information
	Y	Year code (last digit of calendar year)
	YY	Year code (last 2 digits of calendar year)
	WW	Week code (week of January 1 is week '01')
	NNN	Alphanumeric traceability code
	(e3)	Pb-free JEDEC® designator for Matte Tin (Sn)
	*	This package is Pb-free. The Pb-free JEDEC designator ((e3)) can be found on the outer packaging for this package.
	•, ▲, ▼	Pin one index is identified by a dot, delta up, or delta down (triangle mark).
<b>Note:</b>	In the event the full Microchip part number cannot be marked on one line, it will be carried over to the next line, thus limiting the number of available characters for customer-specific information. Package may or may not include the corporate logo.	
	Underbar ( _ ) and/or Overbar ( ¯ ) symbol may not be to scale.	

TABLE 5-1: MARKING CODES

Part Number	Marking Code	Voltage 1	Voltage 2	Auto-Discharge
MIC5380-SSYFT	S2	3.3V	3.3V	No
MIC5380-PPYFT	2P	3.0V	3.0V	No
MIC5380-NGYFT	NG	2.85V	1.8V	No
MIC5380-MGYFT	GM	2.8V	1.8V	No
MIC5380-M4YFT	4M	2.8V	1.2V	No
MIC5380-LLYFT	2L	2.7V	2.7V	No
MIC5380-KHYFT	KH	2.6V	2.0V	No
MIC5380-G4YFT	4G	1.8V	1.2V	No
MIC5381-SSYFT	MK	3.3V	3.3V	Yes
MIC5381-PPYFT	MF	3.0V	3.0V	Yes
MIC5381-MGYFT	MG	2.8V	1.8V	Yes
MIC5381-M4YFT	M4	2.8V	1.2V	Yes
MIC5381-G4YFT	G4	1.8V	1.2V	Yes

# MIC5380/1

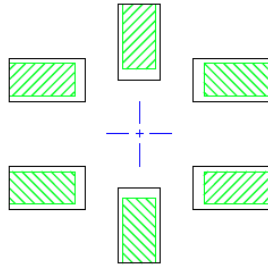
## 6-Lead 1 mm x 1 mm FTQFN Package Outline & Recommended Land Pattern



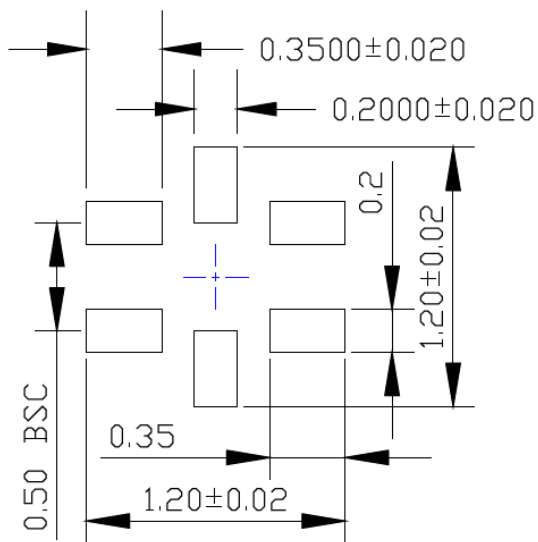
POD-Land Pattern drawing #FTQFN1010-6LD-PL-1

## RECOMMENDED LAND PATTERN

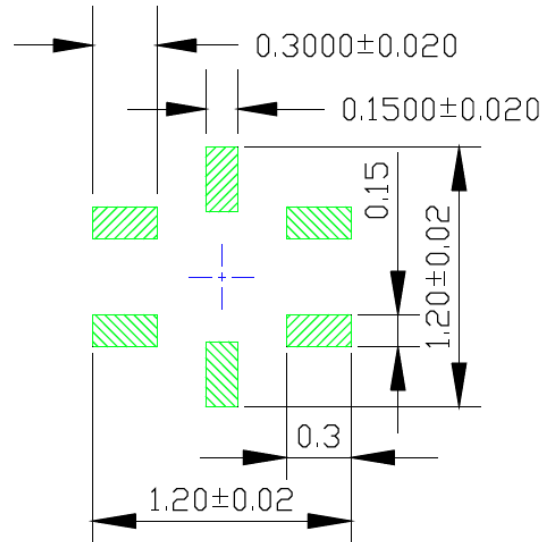
NOTE: 4



STACKED-UP



EXPOSED METAL TRACE



SOLDER STENCIL OPENING

Note: For the most current package drawings, please see the Microchip Packaging Specification located at <http://www.microchip.com/packaging>.

# MIC5380/1

---

NOTES:

## APPENDIX A: REVISION HISTORY

### Revision A (April 2021)

- Converted Micrel document MIC5380/1 to Microchip data sheet template DS20006525A.
- Minor grammatical text changes throughout.
- All schematic and BOM references removed as they are found in the User's Guide for these parts.

# MIC5380/1

---

NOTES:



## PRODUCT IDENTIFICATION SYSTEM

To order or obtain information, e.g., on pricing or delivery, contact your local Microchip representative or sales office.

Device	-X	X	XX	-XX	
Part No.	Output Voltages	Junction Temp. Range	Package	Media Type	
<b>Device:</b>	MIC5380:	High Performance Dual 150mA LDO			
	MIC5381:	High Performance Dual 150mA LDO with Auto-Discharge			
<b>Output Voltages:</b>	SS =	3.3V/3.3V			
	PP =	3.0V/3.0V			
	NG =	2.85V/1.8V (MIC5380 Only)			
	MG =	2.8V/1.8V			
	M4 =	2.8V/1.2V			
	LL =	2.7V/2.7V (MIC5380 Only)			
	KH =	2.6V/2.0V (MIC5380 Only)			
	G4 =	1.8V/1.2V			
<b>Junction Temperature Range:</b>	Y =	-40°C to +125°C			
<b>Package:</b>	MT =	6-Lead 1 mm x 1 mm FTQFN			
<b>Media Type:</b>	TR =	5,000/Reel			
					<b>Examples:</b>
					a) MIC5380-SSYFT-TR: MIC5380, 3.3V/3.3V Output Voltages, -40°C to +125°C Temperature Range, 6-Lead FTQFN, 5,000/Reel
					b) MIC5381-M4YFT-TR: MIC5381, 2.8V/1.2V Output Voltages, -40°C to +125°C Temperature Range, 6-Lead FTQFN, 5,000/Reel
					c) MIC5380-LLYFT-TR: MIC5380, 2.7V/2.7V Output Voltages, -40°C to +125°C Temperature Range, 6-Lead FTQFN, 5,000/Reel
					d) MIC5381-G4YFT-TR: MIC5381, 1.8V/1.2V Output Voltages, -40°C to +125°C Temperature Range, 6-Lead FTQFN, 5,000/Reel
					e) MIC5381-MGYFT-TR: MIC5381, 2.8V/1.2V Output Voltages, -40°C to +125°C Temperature Range, 6-Lead FTQFN, 5,000/Reel
					f) MIC5380-NGYFT-TR: MIC5380, 2.85V/1.8V Output Voltages, -40°C to +125°C Temperature Range, 6-Lead FTQFN, 5,000/Reel
					<b>Note 1:</b> Tape and Reel identifier only appears in the catalog part number description. This identifier is used for ordering purposes and is not printed on the device package. Check with your Microchip Sales Office for package availability with the Tape and Reel option.

# MIC5380/1

---

NOTES:

---

**Note the following details of the code protection feature on Microchip devices:**

- Microchip products meet the specifications contained in their particular Microchip Data Sheet.
- Microchip believes that its family of products is secure when used in the intended manner and under normal conditions.
- There are dishonest and possibly illegal methods being used in attempts to breach the code protection features of the Microchip devices. We believe that these methods require using the Microchip products in a manner outside the operating specifications contained in Microchip's Data Sheets. Attempts to breach these code protection features, most likely, cannot be accomplished without violating Microchip's intellectual property rights.
- Microchip is willing to work with any customer who is concerned about the integrity of its code.
- Neither Microchip nor any other semiconductor manufacturer can guarantee the security of its code. Code protection does not mean that we are guaranteeing the product is "unbreakable." Code protection is constantly evolving. We at Microchip are committed to continuously improving the code protection features of our products. Attempts to break Microchip's code protection feature may be a violation of the Digital Millennium Copyright Act. If such acts allow unauthorized access to your software or other copyrighted work, you may have a right to sue for relief under that Act.

---

Information contained in this publication is provided for the sole purpose of designing with and using Microchip products. Information regarding device applications and the like is provided only for your convenience and may be superseded by updates. It is your responsibility to ensure that your application meets with your specifications.

THIS INFORMATION IS PROVIDED BY MICROCHIP "AS IS". MICROCHIP MAKES NO REPRESENTATIONS OR WARRANTIES OF ANY KIND WHETHER EXPRESS OR IMPLIED, WRITTEN OR ORAL, STATUTORY OR OTHERWISE, RELATED TO THE INFORMATION INCLUDING BUT NOT LIMITED TO ANY IMPLIED WARRANTIES OF NON-INFRINGEMENT, MERCHANTABILITY, AND FITNESS FOR A PARTICULAR PURPOSE OR WARRANTIES RELATED TO ITS CONDITION, QUALITY, OR PERFORMANCE.

IN NO EVENT WILL MICROCHIP BE LIABLE FOR ANY INDIRECT, SPECIAL, PUNITIVE, INCIDENTAL OR CONSEQUENTIAL LOSS, DAMAGE, COST OR EXPENSE OF ANY KIND WHATSOEVER RELATED TO THE INFORMATION OR ITS USE, HOWEVER CAUSED, EVEN IF MICROCHIP HAS BEEN ADVISED OF THE POSSIBILITY OR THE DAMAGES ARE FORESEEABLE. TO THE FULLEST EXTENT ALLOWED BY LAW, MICROCHIP'S TOTAL LIABILITY ON ALL CLAIMS IN ANY WAY RELATED TO THE INFORMATION OR ITS USE WILL NOT EXCEED THE AMOUNT OF FEES, IF ANY, THAT YOU HAVE PAID DIRECTLY TO MICROCHIP FOR THE INFORMATION. Use of Microchip devices in life support and/or safety applications is entirely at the buyer's risk, and the buyer agrees to defend, indemnify and hold harmless Microchip from any and all damages, claims, suits, or expenses resulting from such use. No licenses are conveyed, implicitly or otherwise, under any Microchip intellectual property rights unless otherwise stated.

**Trademarks**

The Microchip name and logo, the Microchip logo, Adaptec, AnyRate, AVR, AVR logo, AVR Freaks, BesTime, BitCloud, chipKIT, chipKIT logo, CryptoMemory, CryptoRF, dsPIC, FlashFlex, flexPWR, HELDO, IGL00, JukeBlox, KeeLoq, Kleer, LANCheck, LinkMD, maXStylus, maXTouch, MediaLB, megaAVR, Microsemi, Microsemi logo, MOST, MOST logo, MPLAB, OptoLyzer, PackeTime, PIC, picoPower, PICSTART, PIC32 logo, PolarFire, Prochip Designer, QTouch, SAM-BA, SenGenuity, SpyNIC, SST, SST Logo, SuperFlash, Symmetricom, SyncServer, Tachyon, TimeSource, tinyAVR, UNI/O, Vectron, and XMEGA are registered trademarks of Microchip Technology Incorporated in the U.S.A. and other countries.

AgileSwitch, APT, ClockWorks, The Embedded Control Solutions Company, EtherSynch, FlashTec, Hyper Speed Control, HyperLight Load, IntelliMOS, Libero, motorBench, mTouch, Powermite 3, Precision Edge, ProASIC, ProASIC Plus, ProASIC Plus logo, Quiet-Wire, SmartFusion, SyncWorld, Temux, TimeCesium, TimeHub, TimePictra, TimeProvider, WinPath, and ZL are registered trademarks of Microchip Technology Incorporated in the U.S.A.

Adjacent Key Suppression, AKS, Analog-for-the-Digital Age, Any Capacitor, AnyIn, AnyOut, Augmented Switching, BlueSky, BodyCom, CodeGuard, CryptoAuthentication, CryptoAutomotive, CryptoCompanion, CryptoController, dsPICDEM, dsPICDEM.net, Dynamic Average Matching, DAM, ECAN, Espresso T1S, EtherGREEN, IdealBridge, In-Circuit Serial Programming, ICSP, INICnet, Intelligent Paralleling, Inter-Chip Connectivity, JitterBlocker, maxCrypto, maxView, memBrain, Mindi, MiWi, MPASM, MPF, MPLAB Certified logo, MPLIB, MPLINK, MultiTRAK, NetDetach, Omniscient Code Generation, PICDEM, PICDEM.net, PICkit, PICtail, PowerSmart, PureSilicon, QMatrix, REAL ICE, Ripple Blocker, RTAX, RTG4, SAM-ICE, Serial Quad I/O, simpleMAP, SimpliPHY, SmartBuffer, SMART-I.S., storClad, SQI, SuperSwitcher, SuperSwitcher II, Switchtec, SynchroPHY, Total Endurance, TSHARC, USBCheck, VariSense, VectorBlox, VeriPHY, ViewSpan, WiperLock, XpressConnect, and ZENA are trademarks of Microchip Technology Incorporated in the U.S.A. and other countries.

SQTP is a service mark of Microchip Technology Incorporated in the U.S.A.

The Adaptec logo, Frequency on Demand, Silicon Storage Technology, and Symmcom are registered trademarks of Microchip Technology Inc. in other countries.

GestIC is a registered trademark of Microchip Technology Germany II GmbH & Co. KG, a subsidiary of Microchip Technology Inc., in other countries.

All other trademarks mentioned herein are property of their respective companies.

© 2021, Microchip Technology Incorporated, All Rights Reserved.

ISBN: 978-1-5224-8007-5

For information regarding Microchip's Quality Management Systems, please visit [www.microchip.com/quality](http://www.microchip.com/quality).



# MICROCHIP

## Worldwide Sales and Service

### AMERICAS

**Corporate Office**  
2355 West Chandler Blvd.  
Chandler, AZ 85224-6199  
Tel: 480-792-7200  
Fax: 480-792-7277  
Technical Support:  
<http://www.microchip.com/support>  
Web Address:  
[www.microchip.com](http://www.microchip.com)

#### Atlanta

Duluth, GA  
Tel: 678-957-9614  
Fax: 678-957-1455

#### Austin, TX

Tel: 512-257-3370

#### Boston

Westborough, MA  
Tel: 774-760-0087  
Fax: 774-760-0088

#### Chicago

Itasca, IL  
Tel: 630-285-0071  
Fax: 630-285-0075

#### Dallas

Addison, TX  
Tel: 972-818-7423  
Fax: 972-818-2924

#### Detroit

Novi, MI  
Tel: 248-848-4000

#### Houston, TX

Tel: 281-894-5983

#### Indianapolis

Noblesville, IN  
Tel: 317-773-8323  
Fax: 317-773-5453  
Tel: 317-536-2380

#### Los Angeles

Mission Viejo, CA  
Tel: 949-462-9523  
Fax: 949-462-9608  
Tel: 951-273-7800

#### Raleigh, NC

Tel: 919-844-7510

#### New York, NY

Tel: 631-435-6000

#### San Jose, CA

Tel: 408-735-9110  
Tel: 408-436-4270

#### Canada - Toronto

Tel: 905-695-1980  
Fax: 905-695-2078

### ASIA/PACIFIC

**Australia - Sydney**  
Tel: 61-2-9868-6733

**China - Beijing**  
Tel: 86-10-8569-7000

**China - Chengdu**  
Tel: 86-28-8665-5511

**China - Chongqing**  
Tel: 86-23-8980-9588

**China - Dongguan**  
Tel: 86-769-8702-9880

**China - Guangzhou**  
Tel: 86-20-8755-8029

**China - Hangzhou**  
Tel: 86-571-8792-8115

**China - Hong Kong SAR**  
Tel: 852-2943-5100

**China - Nanjing**  
Tel: 86-25-8473-2460

**China - Qingdao**  
Tel: 86-532-8502-7355

**China - Shanghai**  
Tel: 86-21-3326-8000

**China - Shenyang**  
Tel: 86-24-2334-2829

**China - Shenzhen**  
Tel: 86-755-8864-2200

**China - Suzhou**  
Tel: 86-186-6233-1526

**China - Wuhan**  
Tel: 86-27-5980-5300

**China - Xian**  
Tel: 86-29-8833-7252

**China - Xiamen**  
Tel: 86-592-2388138

**China - Zhuhai**  
Tel: 86-756-3210040

### ASIA/PACIFIC

**India - Bangalore**  
Tel: 91-80-3090-4444

**India - New Delhi**  
Tel: 91-11-4160-8631

**India - Pune**  
Tel: 91-20-4121-0141

**Japan - Osaka**  
Tel: 81-6-6152-7160

**Japan - Tokyo**  
Tel: 81-3-6880-3770

**Korea - Daegu**  
Tel: 82-53-744-4301

**Korea - Seoul**  
Tel: 82-2-554-7200

**Malaysia - Kuala Lumpur**  
Tel: 60-3-7651-7906

**Malaysia - Penang**  
Tel: 60-4-227-8870

**Philippines - Manila**  
Tel: 63-2-634-9065

**Singapore**  
Tel: 65-6334-8870

**Taiwan - Hsin Chu**  
Tel: 886-3-577-8366

**Taiwan - Kaohsiung**  
Tel: 886-7-213-7830

**Taiwan - Taipei**  
Tel: 886-2-2508-8600

**Thailand - Bangkok**  
Tel: 66-2-694-1351

**Vietnam - Ho Chi Minh**  
Tel: 84-28-5448-2100

### EUROPE

**Austria - Wels**  
Tel: 43-7242-2244-39  
Fax: 43-7242-2244-393

**Denmark - Copenhagen**  
Tel: 45-4485-5910  
Fax: 45-4485-2829

**Finland - Espoo**  
Tel: 358-9-4520-820

**France - Paris**  
Tel: 33-1-69-53-63-20  
Fax: 33-1-69-30-90-79

**Germany - Garching**  
Tel: 49-8931-9700

**Germany - Haan**  
Tel: 49-2129-3766400

**Germany - Heilbronn**  
Tel: 49-7131-72400

**Germany - Karlsruhe**  
Tel: 49-721-625370

**Germany - Munich**  
Tel: 49-89-627-144-0  
Fax: 49-89-627-144-44

**Germany - Rosenheim**  
Tel: 49-8031-354-560

**Israel - Ra'anana**  
Tel: 972-9-744-7705

**Italy - Milan**  
Tel: 39-0331-742611  
Fax: 39-0331-466781

**Italy - Padova**  
Tel: 39-049-7625286

**Netherlands - Drunen**  
Tel: 31-416-690399  
Fax: 31-416-690340

**Norway - Trondheim**  
Tel: 47-7288-4388

**Poland - Warsaw**  
Tel: 48-22-3325737

**Romania - Bucharest**  
Tel: 40-21-407-87-50

**Spain - Madrid**  
Tel: 34-91-708-08-90  
Fax: 34-91-708-08-91

**Sweden - Gothenberg**  
Tel: 46-31-704-60-40

**Sweden - Stockholm**  
Tel: 46-8-5090-4654

**UK - Wokingham**  
Tel: 44-118-921-5800  
Fax: 44-118-921-5820

# Mouser Electronics

Authorized Distributor

Click to View Pricing, Inventory, Delivery & Lifecycle Information:

[Microchip:](#)

[MIC5380-MGYFT-TR](#) [MIC5380-SSYFT-TR](#) [MIC5380-G4YFT-TR](#) [MIC5380-LLYFT-TR](#) [MIC5380-PPYFT-TR](#)  
[MIC5380-NGYFT-TR](#) [MIC5381-PPYFT-TR](#) [MIC5381-MGYFT-TR](#) [MIC5381-M4YFT-TR](#) [MIC5380-M4YFT-TR](#)  
[MIC5381-SSYFT-TR](#) [MIC5381-G4YFT-TR](#) [MIC5380-KHYFT-TR](#)