



MICROCHIP

MCP3564
ADC Evaluation Board V2
for PIC32 MCUs
User's Guide

Note the following details of the code protection feature on Microchip devices:

- Microchip products meet the specification contained in their particular Microchip Data Sheet.
- Microchip believes that its family of products is one of the most secure families of its kind on the market today, when used in the intended manner and under normal conditions.
- There are dishonest and possibly illegal methods used to breach the code protection feature. All of these methods, to our knowledge, require using the Microchip products in a manner outside the operating specifications contained in Microchip's Data Sheets. Most likely, the person doing so is engaged in theft of intellectual property.
- Microchip is willing to work with the customer who is concerned about the integrity of their code.
- Neither Microchip nor any other semiconductor manufacturer can guarantee the security of their code. Code protection does not mean that we are guaranteeing the product as "unbreakable."

Code protection is constantly evolving. We at Microchip are committed to continuously improving the code protection features of our products. Attempts to break Microchip's code protection feature may be a violation of the Digital Millennium Copyright Act. If such acts allow unauthorized access to your software or other copyrighted work, you may have a right to sue for relief under that Act.

Information contained in this publication regarding device applications and the like is provided only for your convenience and may be superseded by updates. It is your responsibility to ensure that your application meets with your specifications. MICROCHIP MAKES NO REPRESENTATIONS OR WARRANTIES OF ANY KIND WHETHER EXPRESS OR IMPLIED, WRITTEN OR ORAL, STATUTORY OR OTHERWISE, RELATED TO THE INFORMATION, INCLUDING BUT NOT LIMITED TO ITS CONDITION, QUALITY, PERFORMANCE, MERCHANTABILITY OR FITNESS FOR PURPOSE. Microchip disclaims all liability arising from this information and its use. Use of Microchip devices in life support and/or safety applications is entirely at the buyer's risk, and the buyer agrees to defend, indemnify and hold harmless Microchip from any and all damages, claims, suits, or expenses resulting from such use. No licenses are conveyed, implicitly or otherwise, under any Microchip intellectual property rights unless otherwise stated.

Trademarks

The Microchip name and logo, the Microchip logo, Adaptec, AnyRate, AVR, AVR logo, AVR Freaks, BesTime, BitCloud, chipKIT, chipKIT logo, CryptoMemory, CryptoRF, dsPIC, FlashFlex, flexPWR, HELDO, IGLOO, JukeBlox, KeeLoq, Klear, LANCheck, LinkMD, maXStylus, maXTouch, MediaLB, megaAVR, Microsemi, Microsemi logo, MOST, MOST logo, MPLAB, OptoLyzer, PackeTime, PIC, picoPower, PICSTART, PIC32 logo, PolarFire, Prochip Designer, QTouch, SAM-BA, SenGenuity, SpyNIC, SST, SST Logo, SuperFlash, Symmetricom, SyncServer, Tachyon, TempTracker, TimeSource, tinyAVR, UNI/O, Vectron, and XMEGA are registered trademarks of Microchip Technology Incorporated in the U.S.A. and other countries.

APT, ClockWorks, The Embedded Control Solutions Company, EtherSynch, FlashTec, Hyper Speed Control, HyperLight Load, IntelliMOS, Libero, motorBench, mTouch, Powermite 3, Precision Edge, ProASIC, ProASIC Plus, ProASIC Plus logo, Quiet-Wire, SmartFusion, SyncWorld, Temux, TimeCesium, TimeHub, TimePictra, TimeProvider, Vite, WinPath, and ZL are registered trademarks of Microchip Technology Incorporated in the U.S.A.

Adjacent Key Suppression, AKS, Analog-for-the-Digital Age, Any Capacitor, AnyIn, AnyOut, BlueSky, BodyCom, CodeGuard, CryptoAuthentication, CryptoAutomotive, CryptoCompanion, CryptoController, dsPICDEM, dsPICDEM.net, Dynamic Average Matching, DAM, ECAN, EtherGREEN, In-Circuit Serial Programming, ICSP, INICnet, Inter-Chip Connectivity, JitterBlocker, KlearNet, KlearNet logo, memBrain, Mindi, MiWi, MPASM, MPF, MPLAB Certified logo, MPLIB, MPLINK, MultiTRAK, NetDetach, Omniscient Code Generation, PICDEM, PICDEM.net, PICKit, PICTail, PowerSmart, PureSilicon, QMatrix, REAL ICE, Ripple Blocker, SAM-ICE, Serial Quad I/O, SMART-I.S., SQL, SuperSwitcher, SuperSwitcher II, Total Endurance, TSHARC, USBCheck, VariSense, ViewSpan, WiperLock, Wireless DNA, and ZENA are trademarks of Microchip Technology Incorporated in the U.S.A. and other countries.

SQTP is a service mark of Microchip Technology Incorporated in the U.S.A.

The Adaptec logo, Frequency on Demand, Silicon Storage Technology, and Symmcom are registered trademarks of Microchip Technology Inc. in other countries.

GestIC is a registered trademark of Microchip Technology Germany II GmbH & Co. KG, a subsidiary of Microchip Technology Inc., in other countries.

All other trademarks mentioned herein are property of their respective companies.

© 2019, Microchip Technology Incorporated, All Rights Reserved.

For information regarding Microchip's Quality Management Systems, please visit www.microchip.com/quality.

ISBN: 978-1-5224-5373-4



Table of Contents

Preface	5
Introduction.....	5
Document Layout	5
Conventions Used in this Guide	6
Recommended Reading.....	7
The Microchip Website	7
Product Change Notification Service.....	7
Customer Support	8
Document Revision History	8
Chapter 1. Product Overview	9
1.1 Introduction	9
1.2 MCP3564 Device Overview	9
1.3 What is the MCP3564 ADC Evaluation Board V2?	9
1.4 MCP3564 ADC Evaluation Board V2 for PIC32 MCUs Kit Contents	10
Chapter 2. Hardware Description	11
2.1 MCP3564 ADC Evaluation Board V2 Hardware Overview	11
2.2 PIM Module and Peripheral Usage Overview	13
2.3 Analog Input Structure	14
2.4 External Voltage reference	14
Chapter 3. Installation	15
3.1 Introduction	15
3.1.1 System Requirements	15
3.2 Energy Management Utility GUI Installation	15
Chapter 4. Energy Management Utility	19
4.1 First Launch (GUI)	19
4.2 System Operation	21
4.2.1 Main Window	21
4.2.2 Data Acquisition Demo View	22
4.2.3 Demo ADC Registers Options	23
Appendix A. Schematics and Layouts	25
A.1 Introduction	25
A.2 Board – Schematic 1	26
A.3 Board – Schematic 2	27
A.4 Board – Schematic 3	28
A.5 Board – Schematic 4	29
A.6 Board – Top Silk	30

MCP3564 ADC Evaluation Board V2 for PIC32 MCUs User's Guide

A.7 Board – Top Copper and Silk	31
A.8 Board – Top Copper	32
A.9 Board – Bottom Copper	33
A.10 Board – Bottom Copper and Silk	34
A.11 Board – Bottom Silk	35
Appendix B. Bill of Materials (BOM)	37
Worldwide Sales and Service	40

Preface

NOTICE TO CUSTOMERS

All documentation becomes dated, and this manual is no exception. Microchip tools and documentation are constantly evolving to meet customer needs, so some actual dialogs and/or tool descriptions may differ from those in this document. Please refer to our website (www.microchip.com) to obtain the latest documentation available.

Documents are identified with a “DS” number. This number is located on the bottom of each page, in front of the page number. The numbering convention for the DS number is “DSXXXXXXXXA”, where “XXXXXXXX” is the document number and “A” is the revision level of the document.

For the most up-to-date information on development tools, see the MPLAB® IDE online help. Select the Help menu, and then Topics, to open a list of available online help files.

INTRODUCTION

This chapter contains general information that will be useful to know before using the MCP3564 ADC Evaluation Board V2. Items discussed in this chapter include:

- [Document Layout](#)
- [Conventions Used in this Guide](#)
- [Recommended Reading](#)
- [The Microchip Website](#)
- [Customer Support](#)
- [Document Revision History](#)

DOCUMENT LAYOUT

This document describes how to use the MCP3564 ADC Evaluation Board V2. The manual layout is as follows:

- **Chapter 1. “Product Overview”** – This chapter provides important information about the MCP3564 ADC Evaluation Board V2.
- **Chapter 2. “Hardware Description”** – This chapter describes the hardware of the MCP3564 ADC Evaluation Board V2.
- **Chapter 3. “Installation”** – This chapter provides information about the “Energy Management Utility GUI” step-by-step installation.
- **Chapter 4. “Energy Management Utility”** – This chapter provides information about the MCP3564 ADC Evaluation Board V2 and the “Energy Management Utility GUI” first launch. This chapter also provides guidance for successful application usage, as well as important information regarding the user interface.
- **Appendix A. “Schematics and Layouts”** – Shows the schematic and PCB layout diagrams for the MCP3564 ADC Evaluation Board V2.
- **Appendix B. “Bill of Materials (BOM)”** – Lists the parts used to build the MCP3564 ADC Evaluation Board V2.

CONVENTIONS USED IN THIS GUIDE

This manual uses the following documentation conventions:

DOCUMENTATION CONVENTIONS

Description	Represents	Examples
Arial font:		
Italic characters	Referenced books	<i>MPLAB® IDE User's Guide</i>
	Emphasized text	...is the <i>only</i> compiler...
Initial caps	A window	the Output window
	A dialog	the Settings dialog
	A menu selection	select Enable Programmer
Quotes	A field name in a window or dialog	"Save project before build"
Underlined, italic text with right angle bracket	A menu path	<u><i>File</i></u> >Save
Bold characters	A dialog button	Click OK
	A tab	Click the Power tab
N'Rnnnn	A number in verilog format, where N is the total number of digits, R is the radix and n is a digit.	4'b0010, 2'hF1
Text in angle brackets < >	A key on the keyboard	Press <Enter>, <F1>
Courier New font:		
Plain Courier New	Sample source code	#define START
	Filenames	autoexec.bat
	File paths	c:\mcc18\h
	Keywords	_asm, _endasm, static
	Command-line options	-Opa+, -Opa-
	Bit values	0, 1
	Constants	0xFF, 'A'
Italic Courier New	A variable argument	<i>file.o</i> , where <i>file</i> can be any valid filename
Square brackets []	Optional arguments	mcc18 [options] <i>file</i> [options]
Curly brackets and pipe character: { }	Choice of mutually exclusive arguments; an OR selection	errorlevel {0 1}
Ellipses...	Replaces repeated text	var_name [, var_name...]
	Represents code supplied by user	void main (void) { ... }

RECOMMENDED READING

This user's guide describes how to use the MCP3564 ADC Evaluation Board V2. Other useful documents are listed below. The following Microchip documents are available and recommended as supplemental reference resources:

- **MCP3561/2/4 Data Sheet – “Two/Four/Eight-Channel, 153.6 ksps, Low-Noise 24-Bit Delta-Sigma ADCs” (DS20006181)**

This data sheet provides detailed information regarding the MCP3564 device.

- **PIC32MX5XX/6XX/7XX Data Sheet – “32-bit Microcontrollers (up to 512 KB Flash and 128 KB SRAM) with Graphics Interface, USB, CAN, and Ethernet” (DS60001156)**

This data sheet provides detailed information regarding the PIC32MX795F512L device.

- **“PIC32MX795F512L 100-pin to 100-pin TQFP CAN-USB Plug-in Module (PIM) Information Sheet” (DS50001949)**

This information sheet provides all needed details regarding the 100-pin PIM interface board functions and PIC32MX795F512L pins.

- **MCP2200 Data Sheet – “USB 2.0 to UART Protocol Converter with GPIO” (DS20002228)**

This data sheet provides detailed information regarding the MCP2200 device.

THE MICROCHIP WEBSITE

Microchip provides online support via our website at www.microchip.com. This website is used as a means to make files and information easily available to customers. Accessible by using your favorite Internet browser, the website contains the following information:

- **Product Support** – Data sheets and errata, application notes and sample programs, design resources, user's guides and hardware support documents, latest software releases and archived software
- **General Technical Support** – Frequently Asked Questions (FAQs), technical support requests, online discussion groups, Microchip consultant program member listing
- **Business of Microchip** – Product selector and ordering guides, latest Microchip press releases, listing of seminars and events, listings of Microchip sales offices, distributors and factory representatives

PRODUCT CHANGE NOTIFICATION SERVICE

Microchip's customer notification service helps keep customers current on Microchip products. Subscribers will receive e-mail notifications whenever there are changes, updates, revisions or errata related to a specified product family or development tool of interest.

To register, access the Microchip website at www.microchip.com, click on **Product Change Notification** and follow the registration instructions.

CUSTOMER SUPPORT

Users of Microchip products can receive assistance through several channels:

- Distributor or Representative
- Local Sales Office
- Embedded Systems Engineer (ESE)
- Technical Support

Customers should contact their distributor, representative or Embedded Systems Engineer (ESE) for support. Local sales offices are also available to help customers. A listing of sales offices and locations is included in the back of this document.

Technical support is available through the website at:

<http://www.microchip.com/support>.

DOCUMENT REVISION HISTORY

Revision A (December 2019)

- Initial release of this document.

Chapter 1. Product Overview

1.1 INTRODUCTION

This chapter provides an overview of the MCP3564 ADC Evaluation Board V2 for PIC32 MCUs.

1.2 MCP3564 DEVICE OVERVIEW

The MCP3564 is a 4-channel, 24-bit, Delta-Sigma Analog-to-Digital Converter (ADC) with a programmable data rate of up to 153.6 ksp/s. It offers integrated features, such as an internal oscillator, temperature sensor and burnout sensor detection, in order to reduce system component count and total solution cost.

The MCP3564 ADC is fully configurable with an Oversampling Ratio (OSR) from 32 to 98304 and a gain from 1/3X to 64X. These devices include an internal sequencer (Scan mode) with multiple monitor channels and a 24-bit timer to automatically create conversion loop sequences without needing MCU communications. Advanced security features, such as CRC and register map lock, can ensure configuration locking and integrity, as well as communication data integrity for secure environments.

These devices come with a 20 MHz SPI-compatible serial interface and communication is largely simplified with 8-bit commands, including various Continuous Read/Write modes and 24/32-bit multiple data formats that can be accessed by the Direct Memory Access (DMA) of an 8-bit, 16-bit or 32-bit MCU.

The MCP3564 is offered in an ultra-small, 3x3 mm, 20-lead UQFN package and is specified over an extended temperature range from -40°C to +125°C.

1.3 WHAT IS THE MCP3564 ADC EVALUATION BOARD V2?

The MCP3564 ADC Evaluation Board V2 for PIC32 MCUs provides the possibility to evaluate the performance of the MCP3564. It also provides a development platform for 32-bit PIC[®] device-based applications using existing 100-pin PIC microcontroller Plug-In Module (PIM) systems that are compatible with the Explorer 16 and other high pin count PIC32 device-based demo boards. The system comes with a programmed PIC32MX795F512L PIM module that communicates with the Energy Management Utility software for data exchange and ADC setup.

The link for downloading the software is available on the evaluation board's web page. For instructions on the use of this software, refer to [Chapter 3. "Installation"](#) of this document.

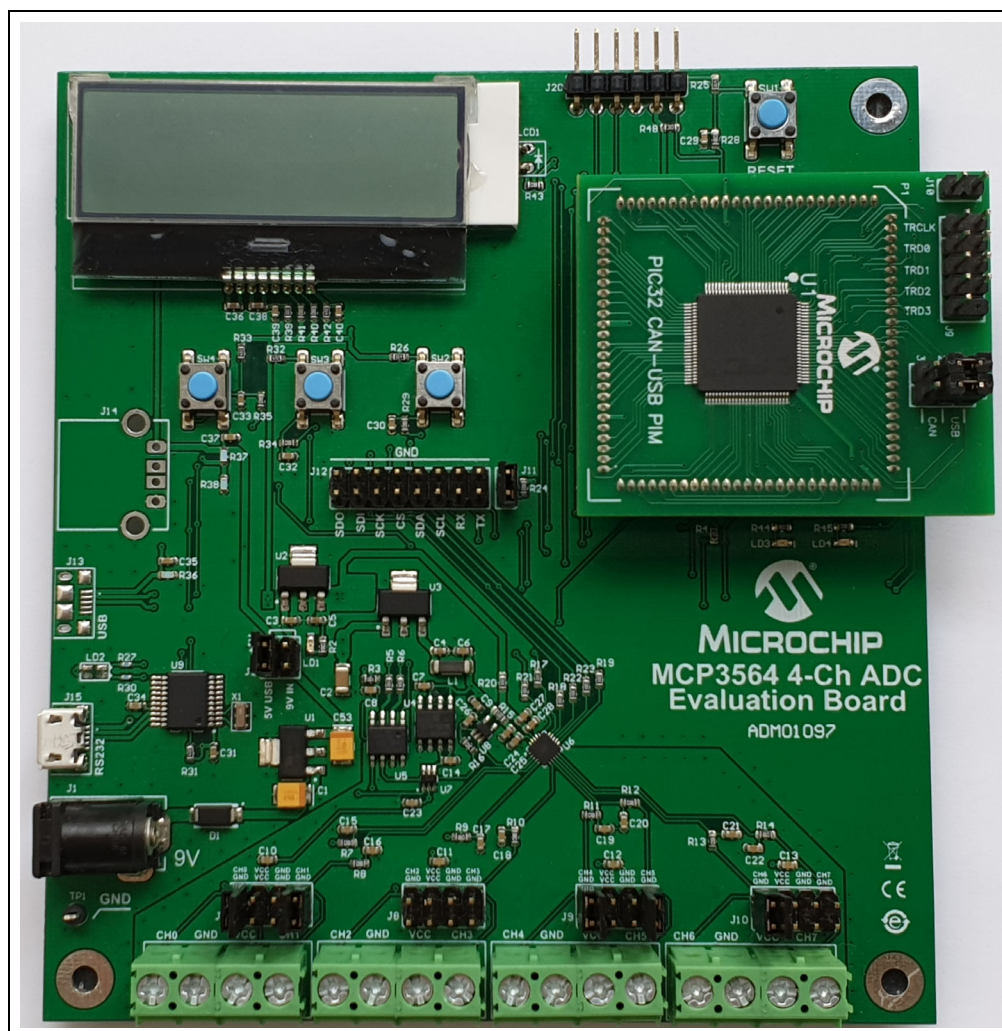

FIGURE 1-1: MCP3564 ADC Evaluation Board V2.

1.4 MCP3564 ADC EVALUATION BOARD V2 FOR PIC32 MCUs KIT CONTENTS

The MCP3564 ADC Evaluation Board V2 for PIC32 MCUs kit includes:

- MCP3564 ADC Evaluation Board V2 for PIC32 MCUs (ADM01097)
- PIC32MX795F512L PIM
- USB Cable
- Jumpers
- Important Information Sheet

Chapter 2. Hardware Description

2.1 MCP3564 ADC EVALUATION BOARD V2 HARDWARE OVERVIEW

The MCP3564 ADC Evaluation Board V2 for PIC32 MCUs represents a solution for integrating the ADC in a functional system with the possibility of interconnection with other boards, extensions and multiple modes of transmitting information to the PC. The evaluation board contains an LCD and three buttons, available for the user, for interfacing with the system.

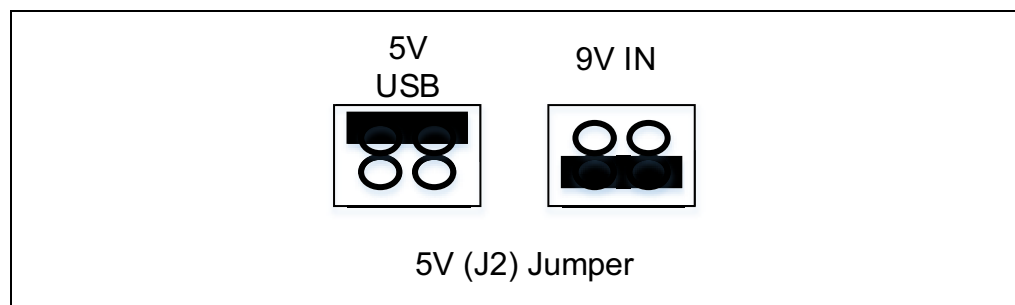

FIGURE 2-1: Power Source Selection.

The power can be selected from one of two sources using the (J2) jumper. The 2.5-5.5 mm jack (J1) is used to power the board during operation with 9V. Each of the mini-USB connectors (J13 and J15) can also provide power without the need for a 9V supply.

The communication with the PC is provided through the MCP2200 USB 2.0 to UART (RS-232) Protocol Converter device or direct USB connection to the PIC32 PIM. By default, the USB socket for direct USB connection (J13) and the USB host socket (J14) are not populated.

MCP3564 ADC Evaluation Board V2 for PIC32 MCUs User's Guide

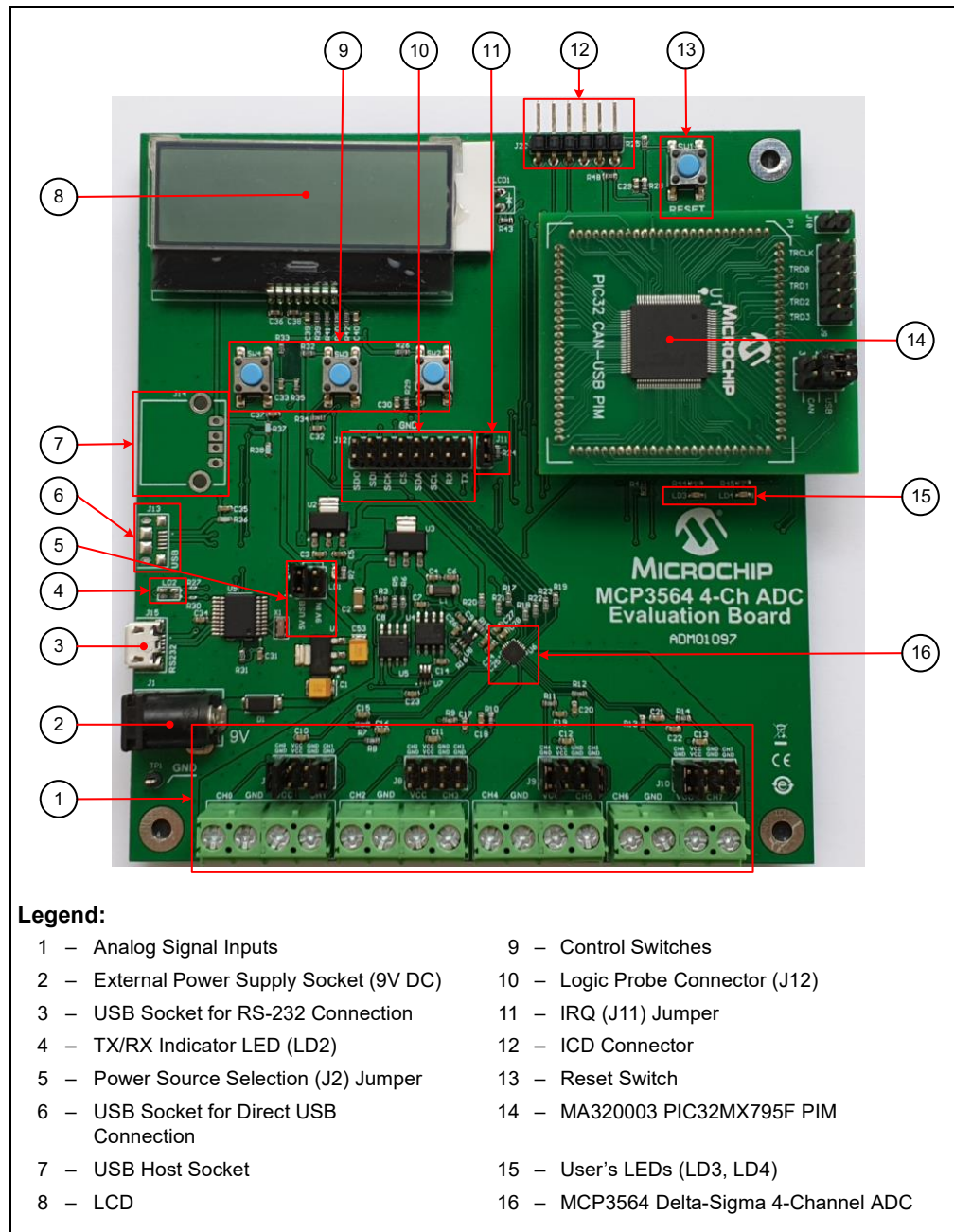

FIGURE 2-2: MCP3564 ADC Evaluation Board V2 Top View.

2.2 PIM MODULE AND PERIPHERAL USAGE OVERVIEW

The MCP3564 ADC Evaluation Board V2 for PIC32 MCUs contains a 100-pin PIM socket compatible with Microchip’s PIM modules. The system comes with one PIM module, the PIC32MX795F512L.

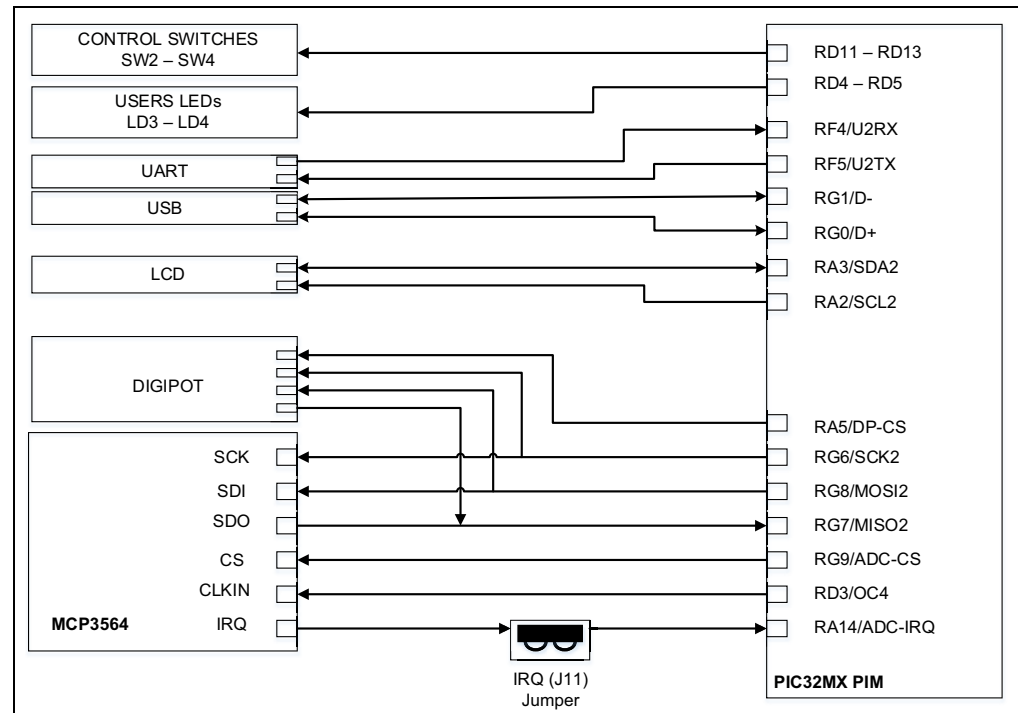

FIGURE 2-3: PIM module Peripheral Usage Overview.

Output Compare 4 is used for clock generation through a PWM signal applied to the CLKIN pin of the MCP3564. The SPI2 bus is shared by the MCP3564 ADC and digital potentiometer, and the $\overline{\text{IRQ}}$ signal is transmitted through the J11 jumper that must be placed before use. The LCD is controlled through the I²C bus, RA2/SCL2 and RA3/SDA2 pins. Communication with the PC can be made directly through the Universal Serial Bus connected to the D+ and D- pins on the RG0 and RG1 ports, or through the MCP2200 USB-UART converter tied on the RF4/U2RX and RF5/U2TX pins.

In order to facilitate connection of a logic analyzer device, the MCP3564 ADC Evaluation Board V2 was designed with a multipoint connector (J12) that allows sampling of the signals between the PIM, ADC and DigiPot on the SPI2 bus, as well as the MCP2200 RX/TX pins and the $\overline{\text{IRQ}}$ status pin.

Note: Without the $\overline{\text{IRQ}}$ jumper on the J11 connector, the user will have to set the $\overline{\text{IRQ_MODE}}[0]$ bit ($\overline{\text{IRQ}}$ Pin Inactive State Selection) from the $\overline{\text{IRQ}}$ Register (0x05) to '1' (the inactive state is logic high). Jumpers are included in the package.

More details can be found in [Appendix A. “Schematics and Layouts”](#) and [Appendix B. “Bill of Materials \(BOM\)”](#) with all schematics included, as well as the BOM.

2.3 ANALOG INPUT STRUCTURE

Four differential input paths allow external signal sources to be easily connected to the MCP3564 inputs. Screw terminal connectors J3-J6 are four-pin connectors that act as both screw-type and clip-on port connectors.

Note: To use a screw terminal connector as a port connector, pull up the green plastic top to access the ports.

The J3-J6 connectors can be used as a differential or single-ended configuration. The J7 to J10 connectors are designed to be used as an easy way to connect an external device or an active sensor that needs power. Each J7 to J10 connector has: the channel input, the analog GND and V_{CC} (3.3V) pins.

2.4 EXTERNAL VOLTAGE REFERENCE

For the MCP3564 ADC Evaluation Board V2 application, there are two options for the voltage reference. Both options are related to the external V_{REF} . In the Edit Registers window at the " V_{REF} Option" section of the GUI, just two options are available: "External 2.5V" and "External-DP". By choosing the "External-DP" option, the "DigiPot (MSB Value)" section becomes active and a value can be input by the user. The DigiPot value (0 to 255) is the equivalent of the desired reference voltage obtained from the DigiPot, where 255 is the equivalent of 3.3V. By choosing the "External 2.5V" (set by default), a high-accuracy fixed voltage output is provided by an external IC.

As is shown in the following schematic representation, the external V_{REF} source can be selected using the IC switch, which is controlled by the MCU. The IC switch output is connected to the V_{REF} positive input of the ADC through an RC low-pass filter, and an MCP6V91UT op amp configured as a unity gain buffer.

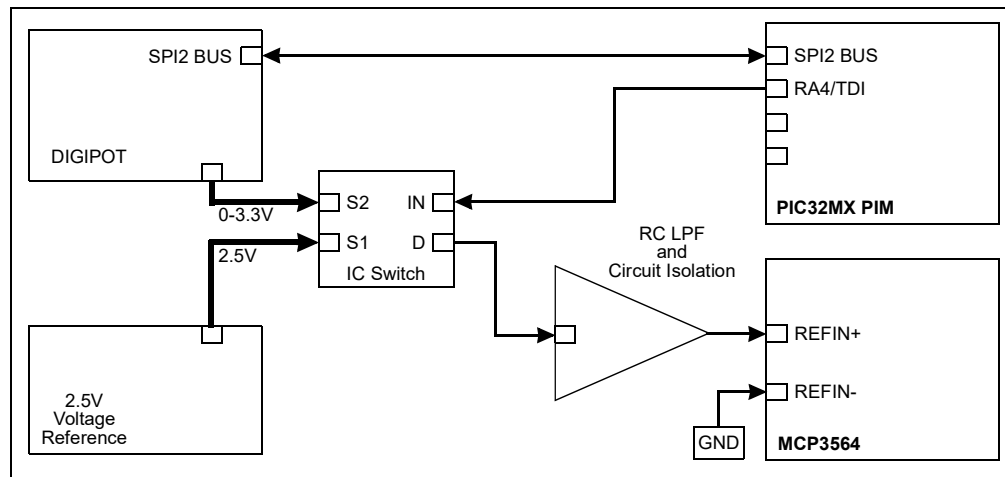

FIGURE 2-4: Schematic Representation of the Voltage Reference Circuit.

Chapter 3. Installation

3.1 INTRODUCTION

This section describes how to install and use the Energy Management Utility GUI, required in order to connect to and interact with the MCP3564 ADC Evaluation Board V2.

The Energy Management Utility GUI allows the user to evaluate the MCP3564 ADC device for the replication of the analog input signal into a graph chart with calculation of the main signal properties, as well as the acquisition parameters.

3.1.1 System Requirements

The MCP3564 ADC Evaluation Board V2 is designed to be used with a PC running Microsoft® Windows® 7 or later. For USB connectivity, the minimal physical requirement for the PC is a standard type-A USB 2.0 port.

3.2 ENERGY MANAGEMENT UTILITY GUI INSTALLATION

Go to www.microchip.com, search for the MCP3564 device and download the Energy Management Utility (Version 1.4 or newer).

The Energy Management Utility is a GUI that supports the following evaluation boards:

- MCP3910 ADC Evaluation Board (ADM00425)
- MCP3911 ADC Evaluation Board (ADM00398)
- MCP3913 ADC Evaluation Board (ADM00522)
- MCP3914 ADC Evaluation Board (ADM00523)
- MCP3564 ADC Evaluation Board (ADM00583)
- MCP3564 ADC Evaluation Board V2 (ADM01097)

In order to install the software, the following steps must be completed.

1. Click the **Next** button to continue.



FIGURE 3-1: Energy Management Utility – Setup Window.

2. Read and accept the License Agreement. Click the **Next** button to proceed.

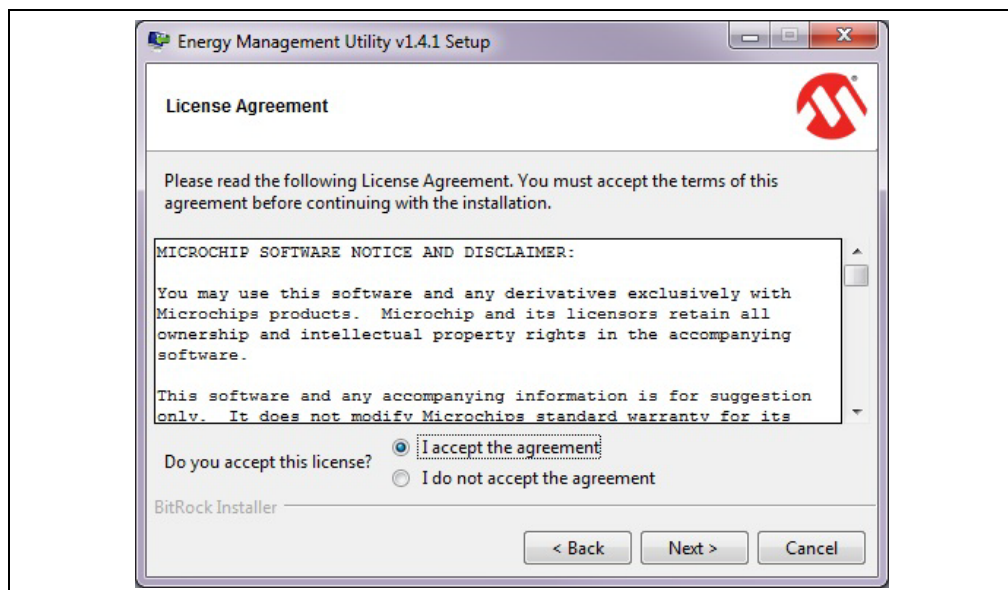

FIGURE 3-2: Energy Management Utility – License Agreement Window.

3. Choose the desired installation directory and click **Next**.

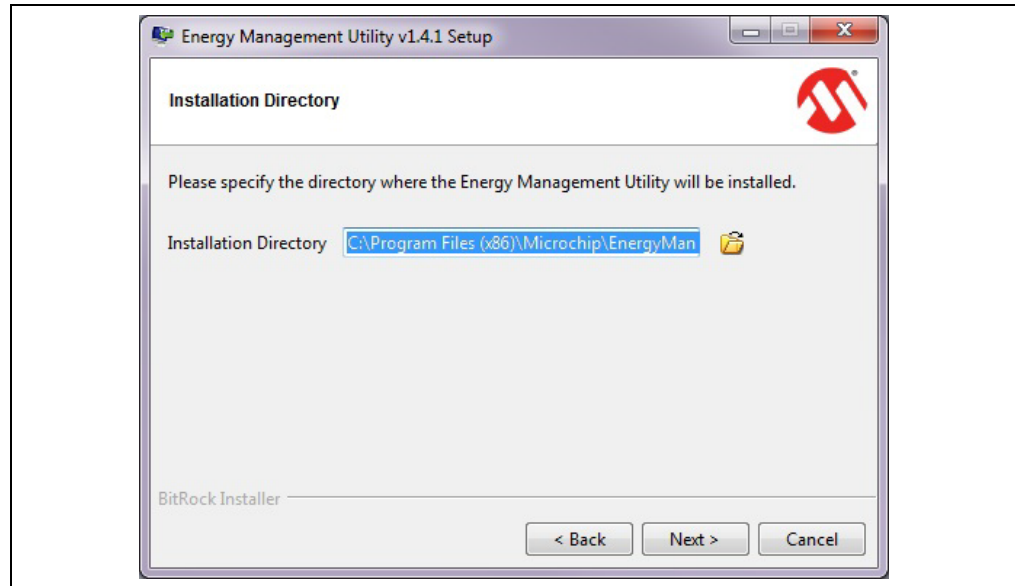

FIGURE 3-3: Energy Management Utility – Installation Directory Window.

4. Wait for the setup wizard to finish the installation.

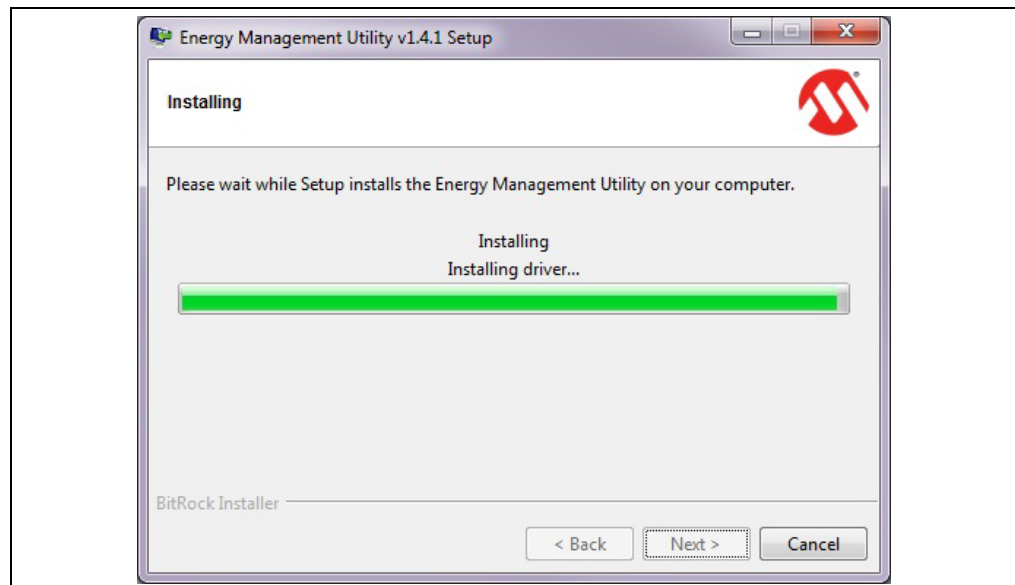

FIGURE 3-4: Energy Management Utility – Installing Window.

5. Once the installation is completed, click **Finish** to exit the setup wizard.

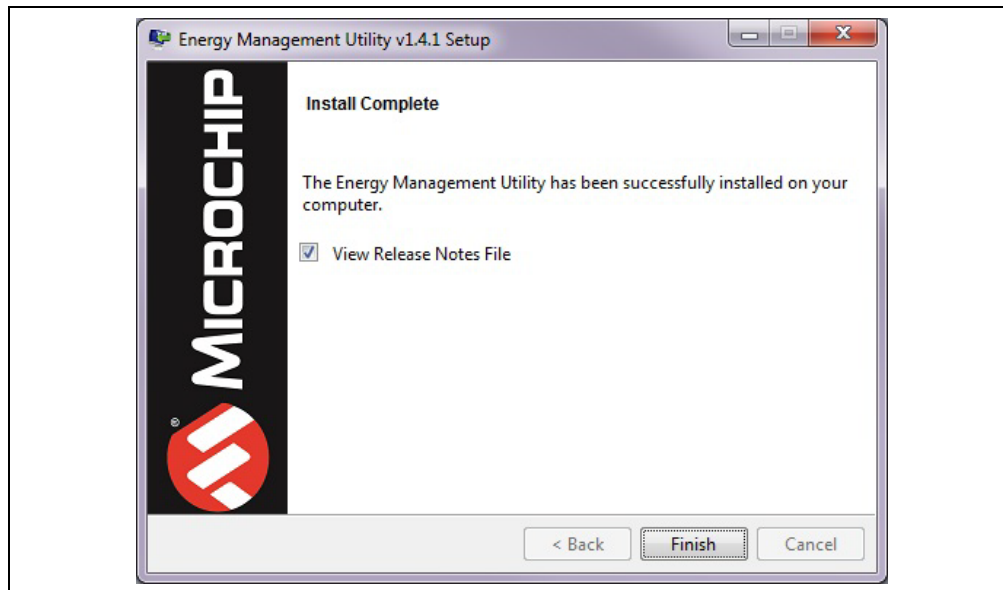

FIGURE 3-5: Energy Management Utility – Install Complete Window.

Chapter 4. Energy Management Utility

4.1 FIRST LAUNCH (GUI)

The MCP3564 ADC Evaluation Board V2 (or another compatible board) is required in order to use the Graphical User Interface (GUI).

First of all, make sure that the hardware (HW) is properly prepared for use as is described in [Chapter 2. “Hardware Description”](#).

Before use, make sure that the programmed PIM module is properly inserted and the J1 and J2 jumpers (on the PIM) are on the USB position.

In order to connect the MCP3564 ADC Evaluation Board V2 to the PC, a micro-USB cable is required (the cable is included in the kit).

Note: J13 provides the direct USB connection to the PIC32MX USB peripheral that emulates a VCP (Virtual COM Port). The J15 socket is the USB interface of the serial to UART converter (MCP2200 serial port converter).

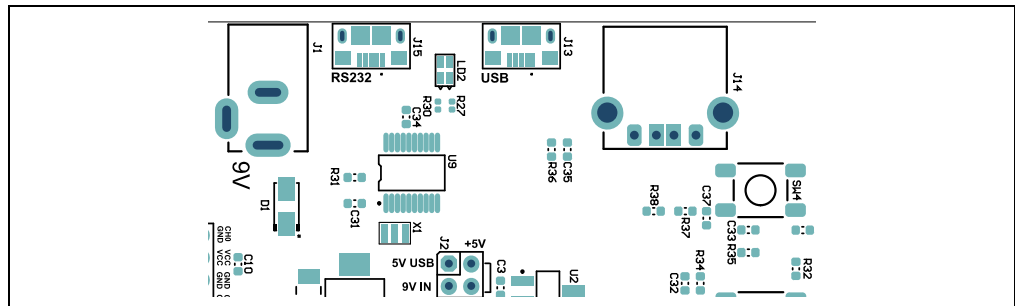

FIGURE 4-1: Schematic Representation of the Available USB Connectors (J1, J15, J13 and J14).

Note: The two connection sockets, J13 and J15, cannot be used at the same time. The firmware will automatically detect the interface being used. In Windows® 8 and later, all the necessary drivers should be automatically installed. If drivers are needed, please refer to the MCP2200 product page (www.microchip.com/mcp2200).

The MCP3564 ADC Evaluation Board V2 power source is selected by the J2 jumper and can be powered by the USB port or external 9V DC supply. Once the board is powered, LD1 lights up and the “MCP3564 4Ch Demo” message is displayed on the LCD.



FIGURE 4-2: Representation of the LCD Message.

Once the hardware is connected, the Energy Management Utility GUI can be started. The software recognizes the device ID and displays the corresponding evaluation board number (ADM01097 for MCP3564 ADC Evaluation Board V2) and the COM port of the connection.

If the connection status is "Not Connected" (Figure 4-5, Number 6), repeat the hardware connection process, press the **Connect** button (Figure 4-5, number 11) and select the corresponding COM Port.

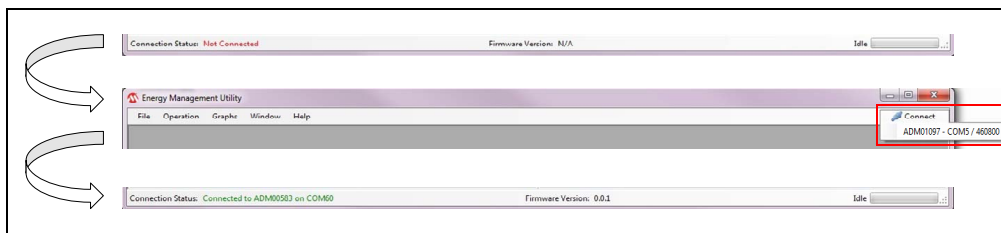

FIGURE 4-3: Representation of the Connect/Disconnect Procedure.

Once the hardware is properly connected, the default settings are uploaded into the ADC and the application is ready to be used. By pressing the **Run** button, the data acquisition starts and the status label (Figure 4-5, Number 7) changes from Idle to running.

After a few seconds (two complete readings are required), all information boxes start to display the input data and the graphs are plotted in each channel's Chart window.

Disconnecting the USB will display a communication error dialog box, as shown in Figure 4-4, indicating the hardware was not detected.



FIGURE 4-4: Hardware Not Detected Dialog Box.

To launch the evaluation board application, the following steps must be checked:

1. Set up the HW as shown in **Chapter 2. "Hardware Description"**.
2. Connect the micro-USB cable to one of the USB sockets.
3. Run the Energy Management Utility.
4. Select the channels to be displayed (by default, CH0 and CH1 are selected).
5. Press the **Run** button in order to start data acquisition.

4.2 SYSTEM OPERATION

Once the system is successfully launched ([Section 4.1 “First Launch \(GUI\)”](#)), there are some basic things to consider in order to ensure the system is fully operational:

- Control switches, SW3 and SW4, are software connected to LD3 and LD4, respectively. By pressing any of those buttons, the related LEDs will light up.
- During the acquisition process, after pressing the **Run** button, each data frame sent to the PC is signaled by LD2 (when the J15 RS-232 port is used) or LD3 (when the J13 USB port is used).

<p>Note: If the MCP3564 ADC Evaluation Board V2 does not respond as described, the Reset button should be used (Figure 2-2, Number 13).</p>

4.2.1 Main Window

The Energy Management Utility GUI has four main components on the user's window:

- The control menu bar ([Figure 4-5](#), Number 1) provides access to File, Operation, Graphs, Window and Help menus that are intuitive and easy to access, as well as the **Connect** button for reconnecting to the MCP3564 ADC Evaluation Board V2
- The application control toolbar contains:
 - The **Run** button – starts or resumes (if application was stopped) the data acquisition process
 - The **Stop** button – freezes all the data displayed on the Main window and stops the data transmission from the evaluation board to the PC
 - The **Edit Registers** button – opens the MCP3564 Register Settings window
 - The Real-Time Temperature box – shows the temperature in Celsius degrees
 - Two channel selection drop-down lists
- The graphs and signal information section is divided in two similar areas for the corresponding channel characterization
- The status toolbar provides information related to the:
 - Connection status of the board and the COM port
 - Firmware version
 - Current process status

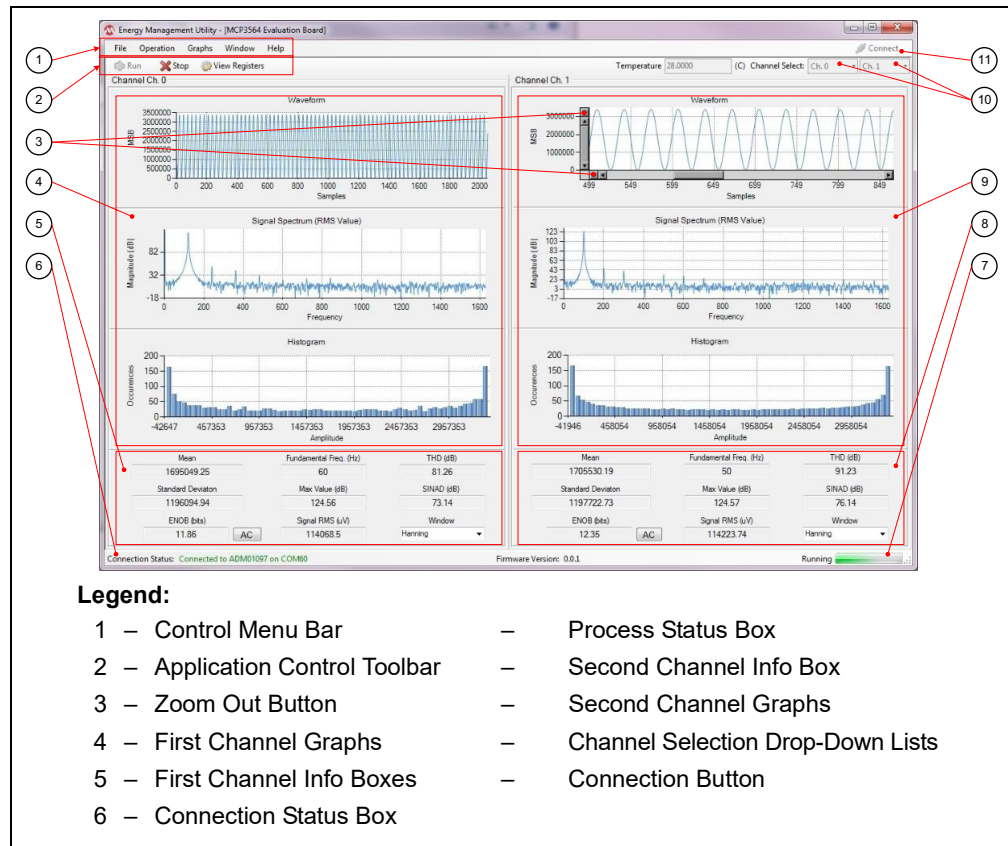

FIGURE 4-5: Main Window.

4.2.2 Data Acquisition Demo View

To start the data acquisition, two input channels have to be selected; Channel 0 and Channel 1 are chosen by default.

There are three info graphs available on the window: the MSB, the Magnitude and the Occurrences graphs. The refresh rate of the input data is related to the speed of the acquisition process, ADC CLKIN value, OSR value and update rate (in the Operation menu). Each data acquisition frame is 2048 samples per channel (this value cannot be modified).

For a better visualization, there is a zoom-in option available by clicking and dragging with the mouse on the desired graph. Zoom-out can be performed by using the **Zoom-Out** button on each graph's axis (Figure 4-5, Number 3). By default, the graphs are set to auto-scale, but that can be changed by selecting "Manual Scale" in the following menu:

Graphs>Graphs Settings>Waveform>Left-Right Plot

More options for the graph representation tuning can be found in the Graph Settings window.

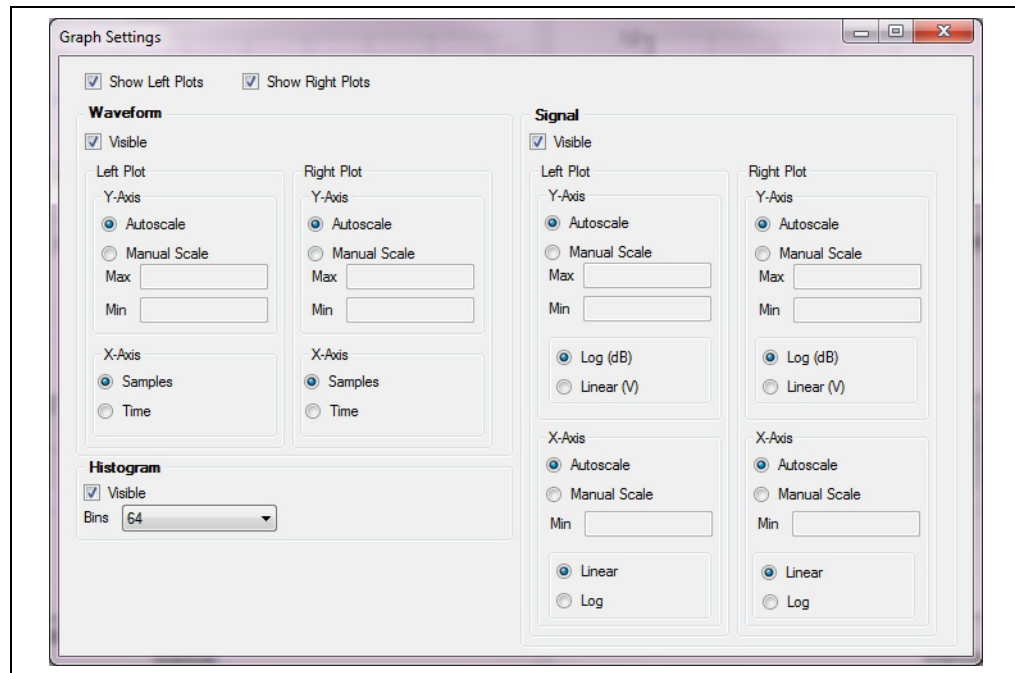
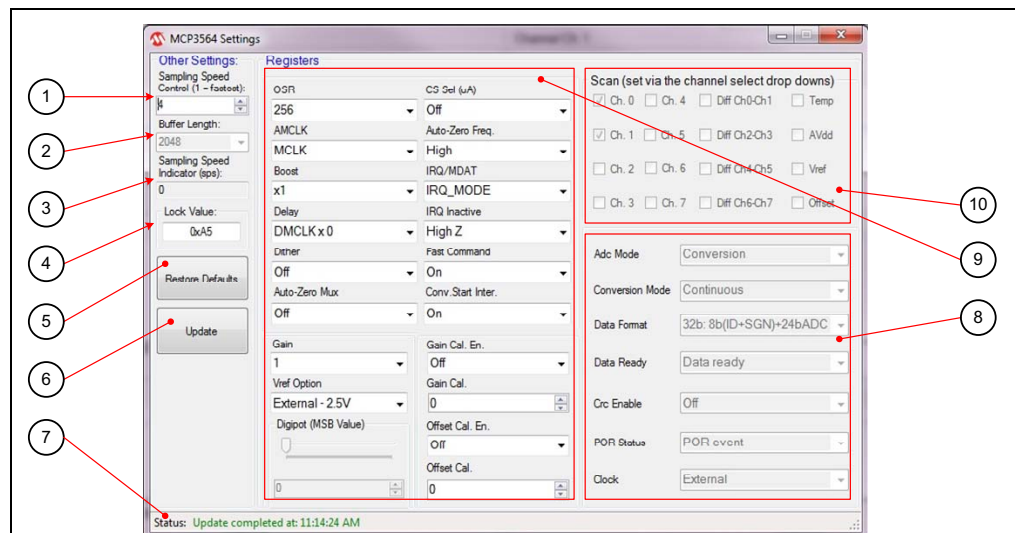

FIGURE 4-6: Graph Settings Window.

4.2.3 Demo ADC Registers Options

To access the Edit Registers option, the data acquisition process must be stopped.

Once the application status field displays the “Stopped” message, the **Edit Registers** button (on the application toolbar) can be clicked and the MCP3564 Settings window will appear.



Legend:

- 1 – ADC CLKIN Control
- 2 – Buffer Length (info)
- 3 – Sampling Speed (info)
- 4 – Lock Value
- 5 – Default Settings Button
- 6 – Read All ADC Registers
- 7 – Status Box
- 8 – Inactive Registers Boxes (info only)
- 9 – Active Registers Boxes
- 10 – ADC Scan Register (info)

FIGURE 4-7: MCP3564 Settings Window.

This window has the following three main parts:

- The “Registers” field contains the main MCP3564 internal registers. This provides direct access to the ADC registers by selecting a particular option from the drop-down lists that are active. The inactive register drop-downs, on the right side (Figure 4-7, Number 8), are set to a default option needed for the MCP3564 ADC Evaluation Board V2 application and are not configurable.
- The “Other Settings” field provides:
 - Sampling Speed Control – modifies the value of the ADC external input clock
 - Buffer Length – has a fixed value and it cannot be modified
 - Sampling Speed Indicator – provides information about the actual computed value of the sampling speed of the last acquisition buffer
 - Lock Value (0xA5) – is the default value of the ADC Lock Register
 - Restore Defaults
 - **Update** button – reads all the registers from the MCP3564 and refreshes all text boxes in the “Registers” field

Note: The new selected values of the registers are automatically written into the ADC.

- The Status toolbar provides information about the updating process and the exact time of the completion (Figure 4-7, Number 7).



MCP3564 ADC EVALUATION BOARD V2 FOR PIC32 MCUs USER'S GUIDE

Appendix A. Schematics and Layouts

A.1 INTRODUCTION

This appendix contains the following schematics and layouts for the MCP3564 ADC Evaluation Board V2 for PIC32 MCUs.

- [Board – Schematic 1](#)
- [Board – Schematic 2](#)
- [Board – Schematic 3](#)
- [Board – Schematic 4](#)
- [Board – Top Silk](#)
- [Board – Top Copper and Silk](#)
- [Board – Top Copper](#)
- [Board – Bottom Copper](#)
- [Board – Bottom Copper and Silk](#)
- [Board – Bottom Silk](#)

A.2 BOARD – SCHEMATIC 1

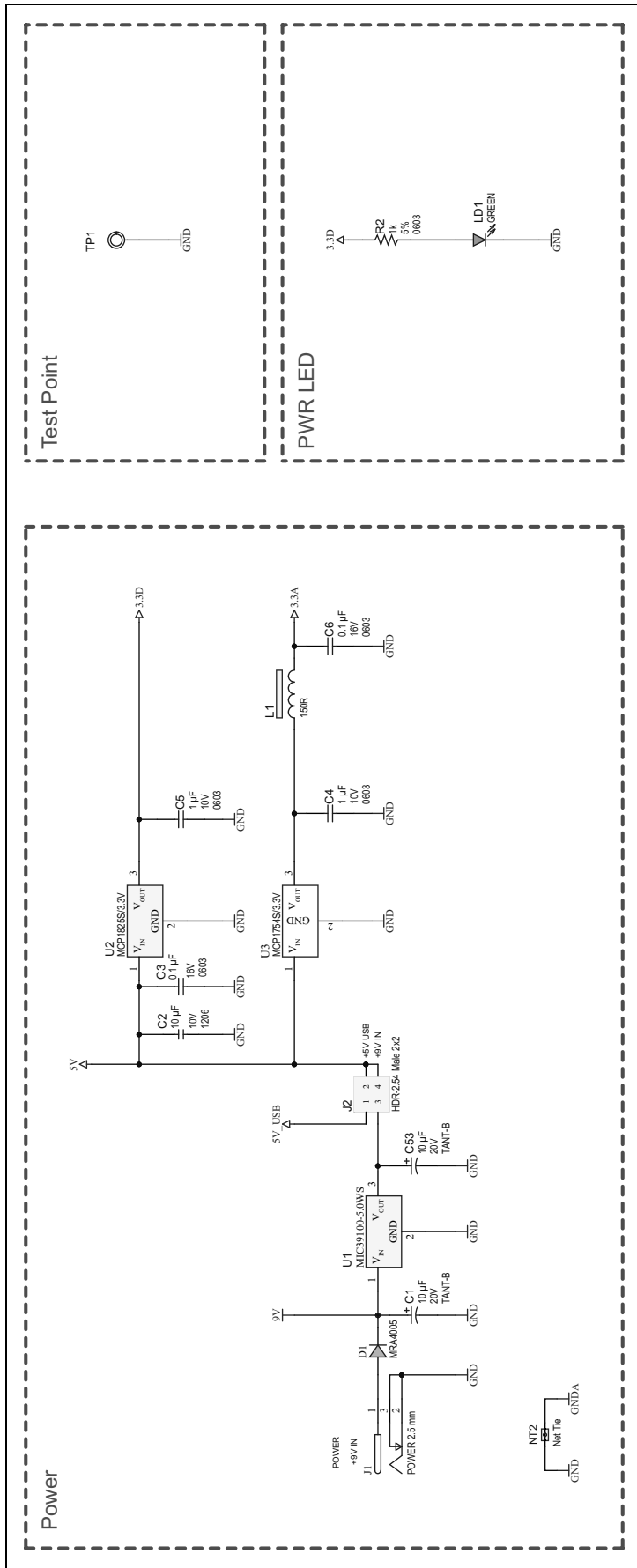

A.3 BOARD – SCHEMATIC 2

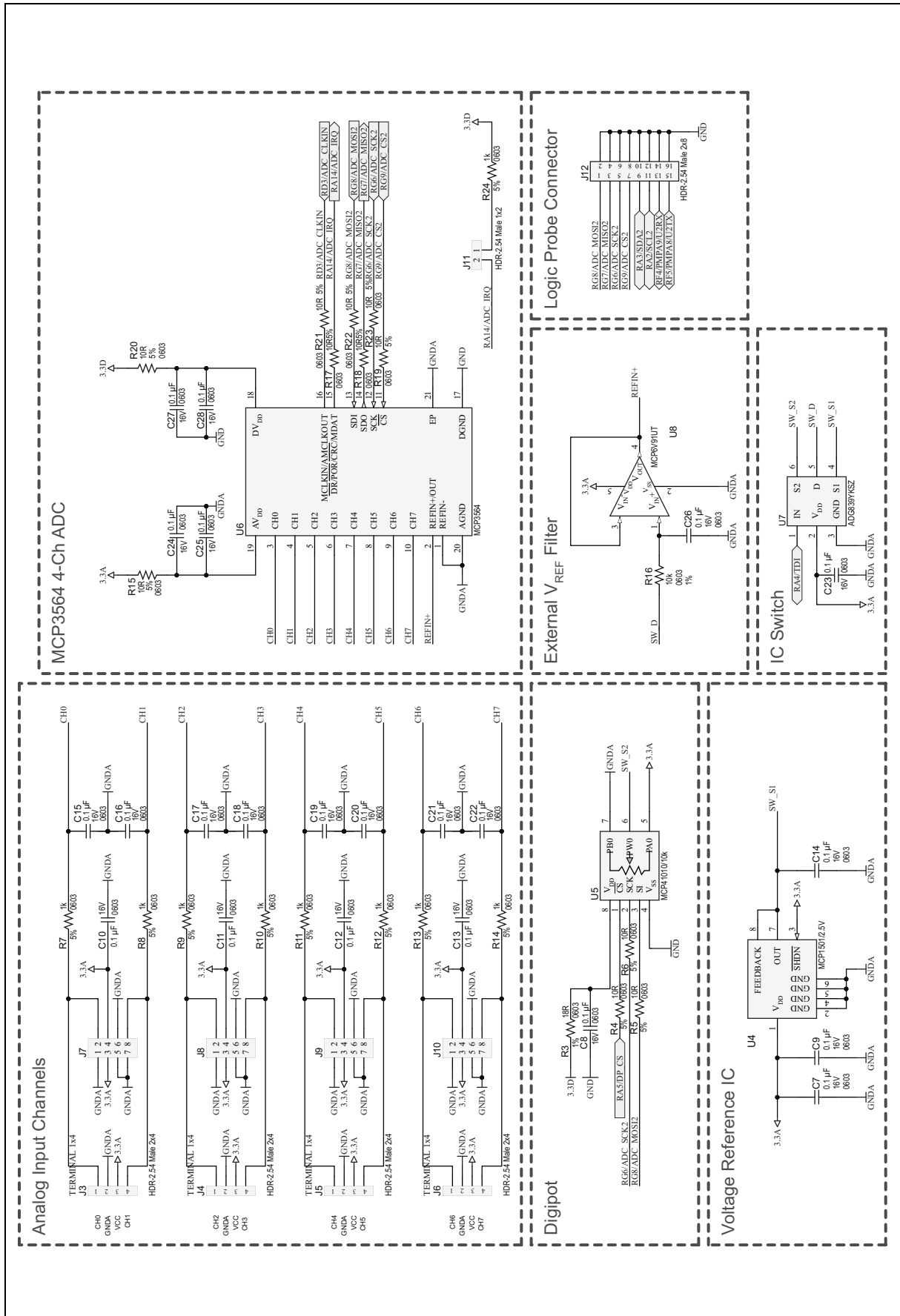

A.4 BOARD – SCHEMATIC 3

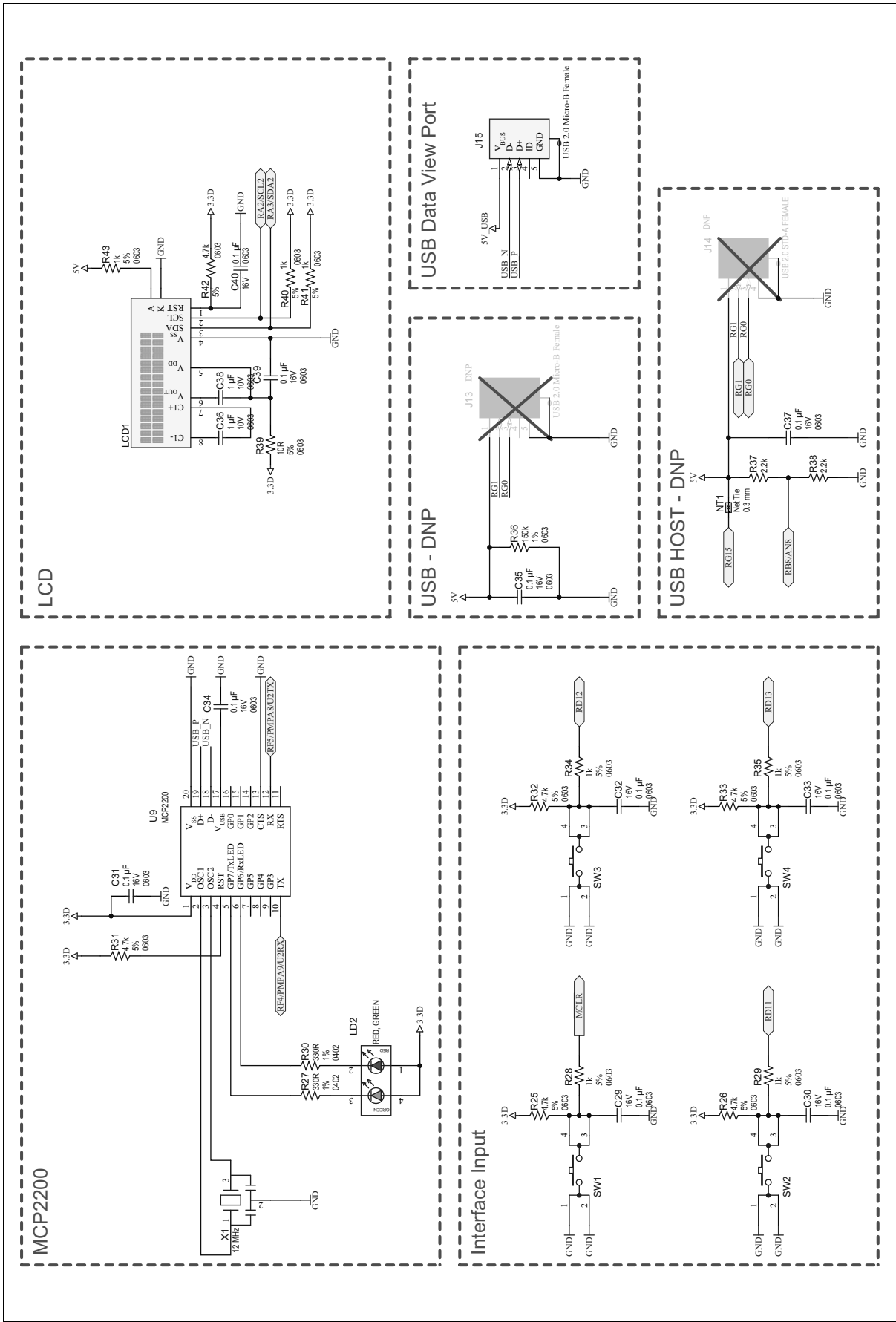

A.5 BOARD – SCHEMATIC 4

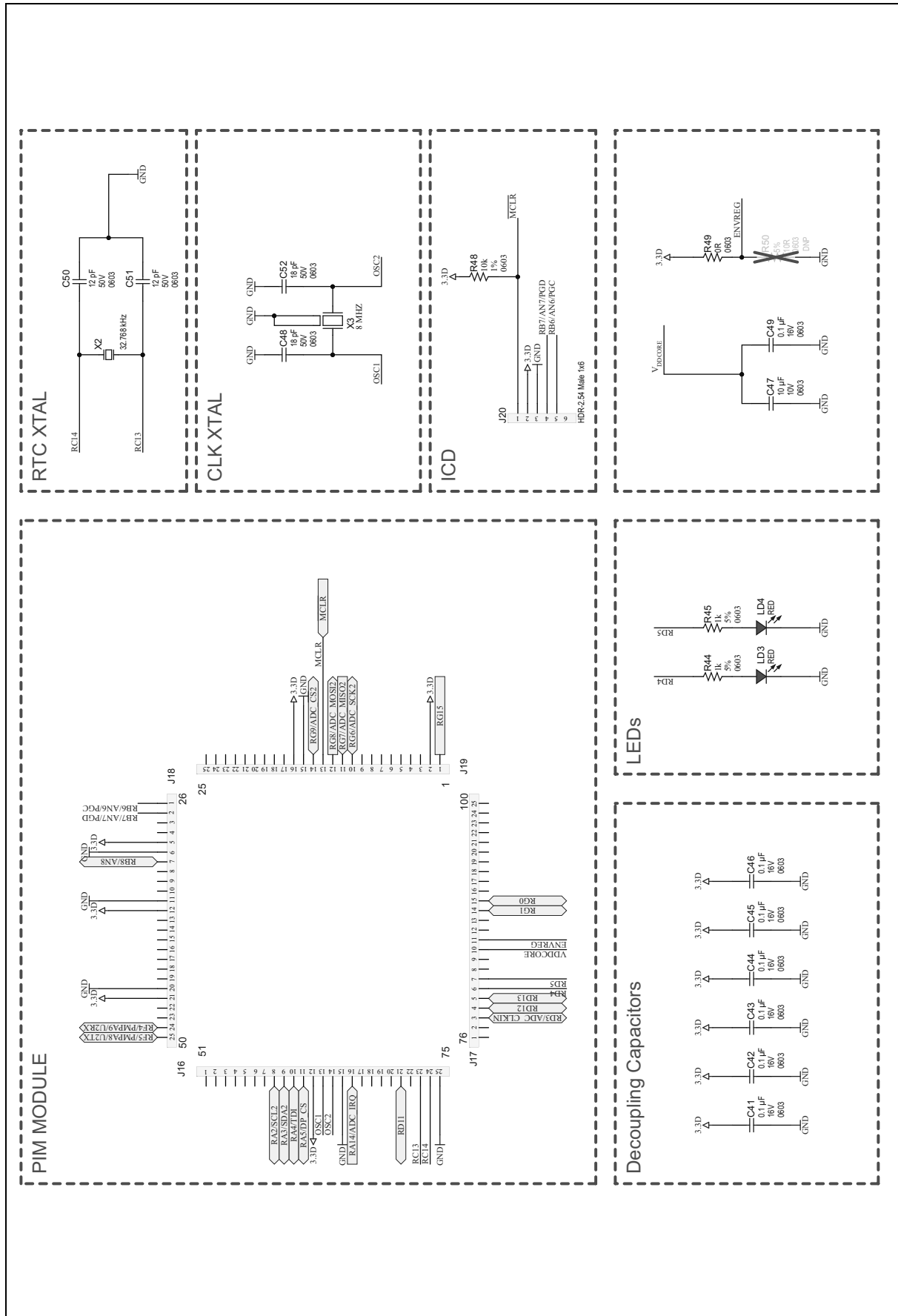

A.6 BOARD – TOP SILK

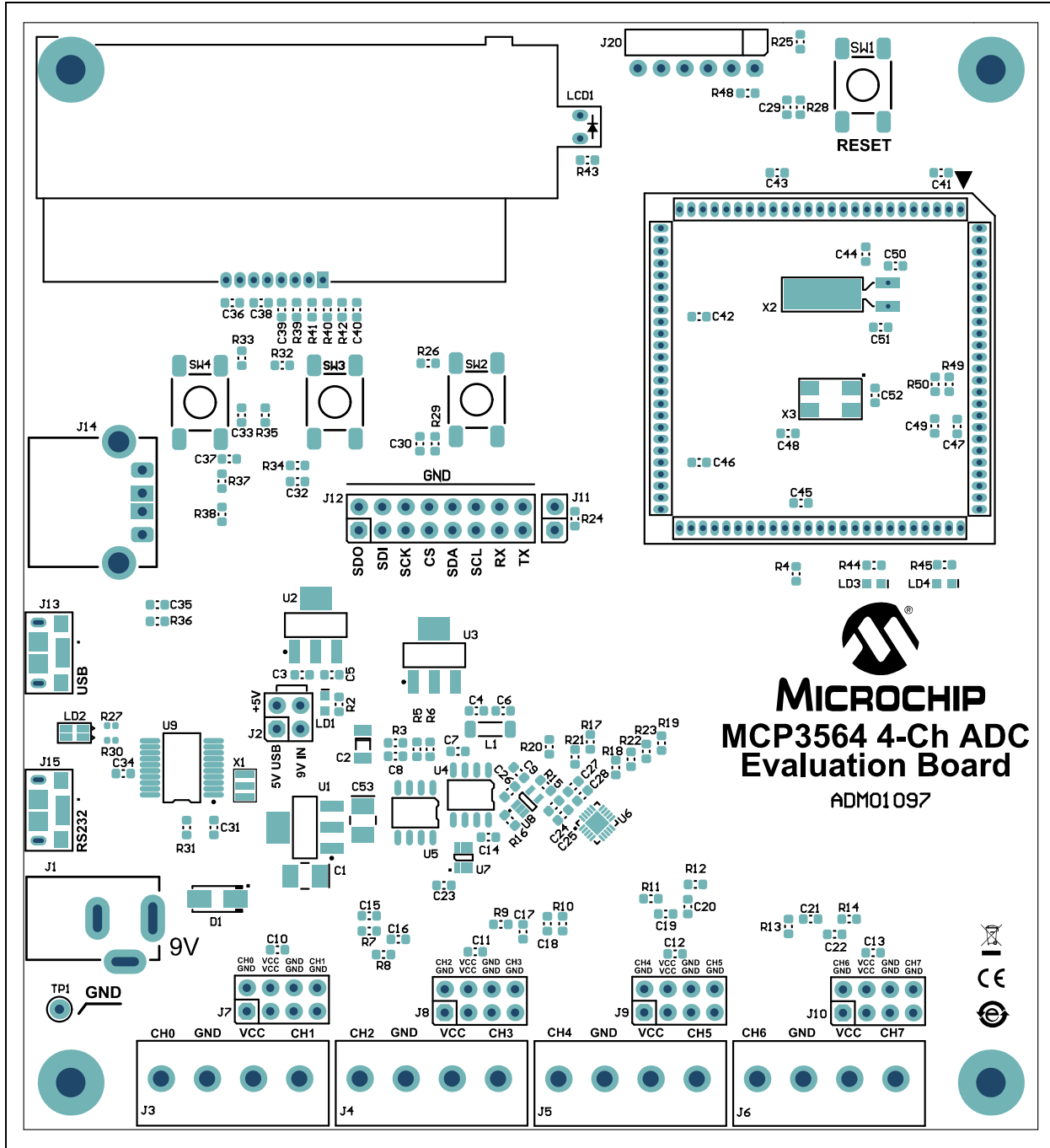

A.7 BOARD – TOP COPPER AND SILK

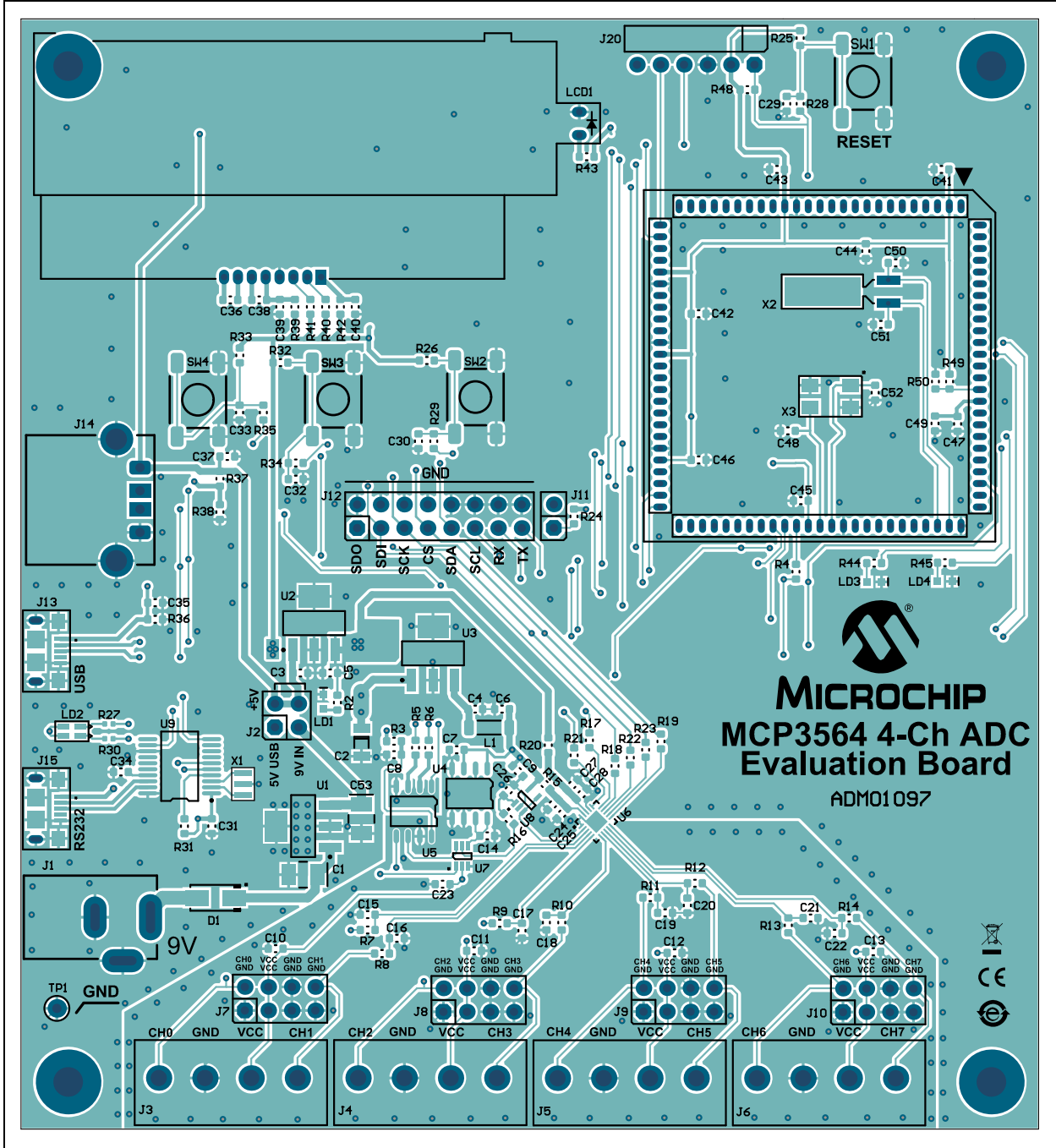

A.8 BOARD – TOP COPPER

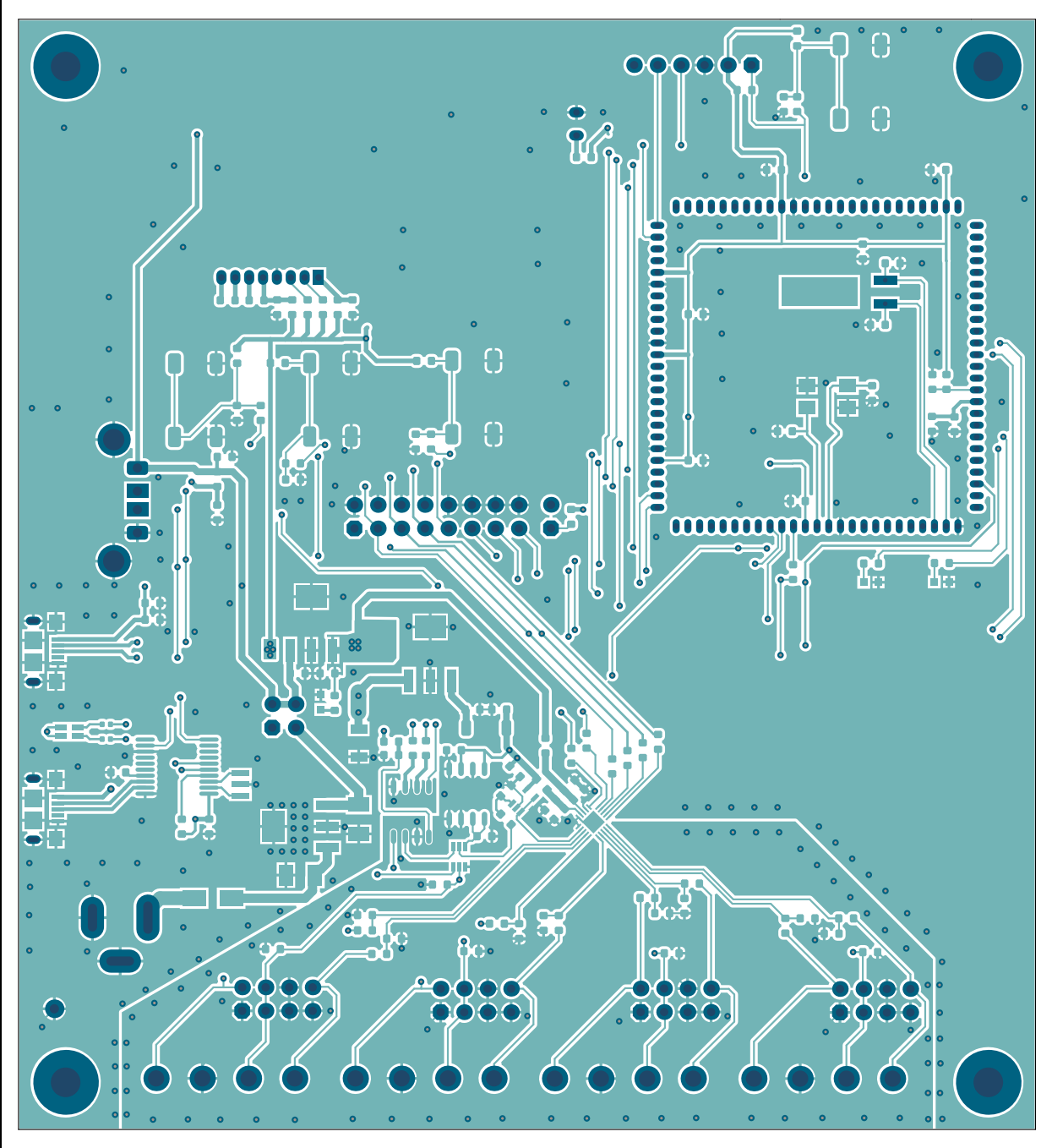

A.9 BOARD – BOTTOM COPPER

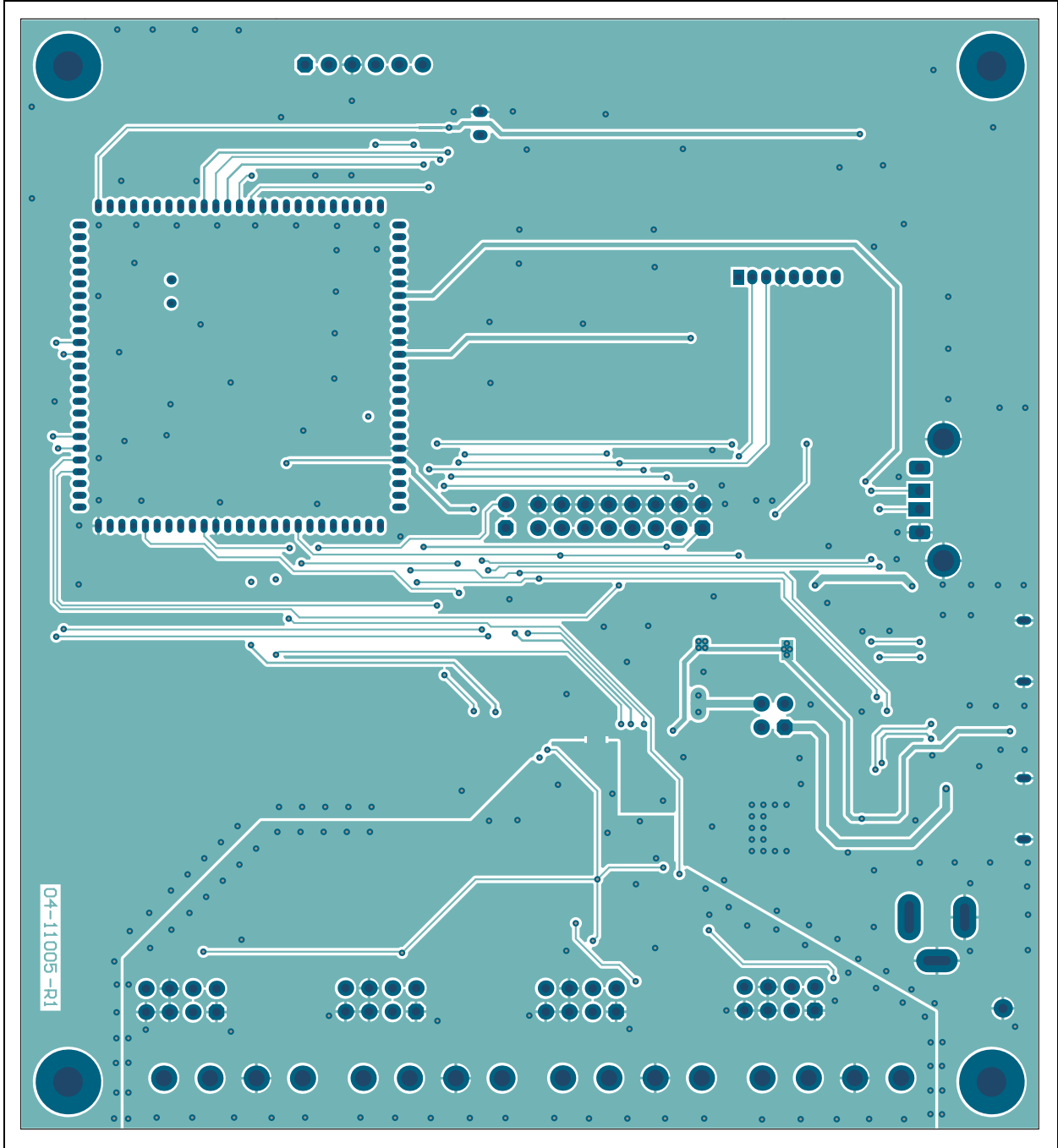

A.10 BOARD – BOTTOM COPPER AND SILK

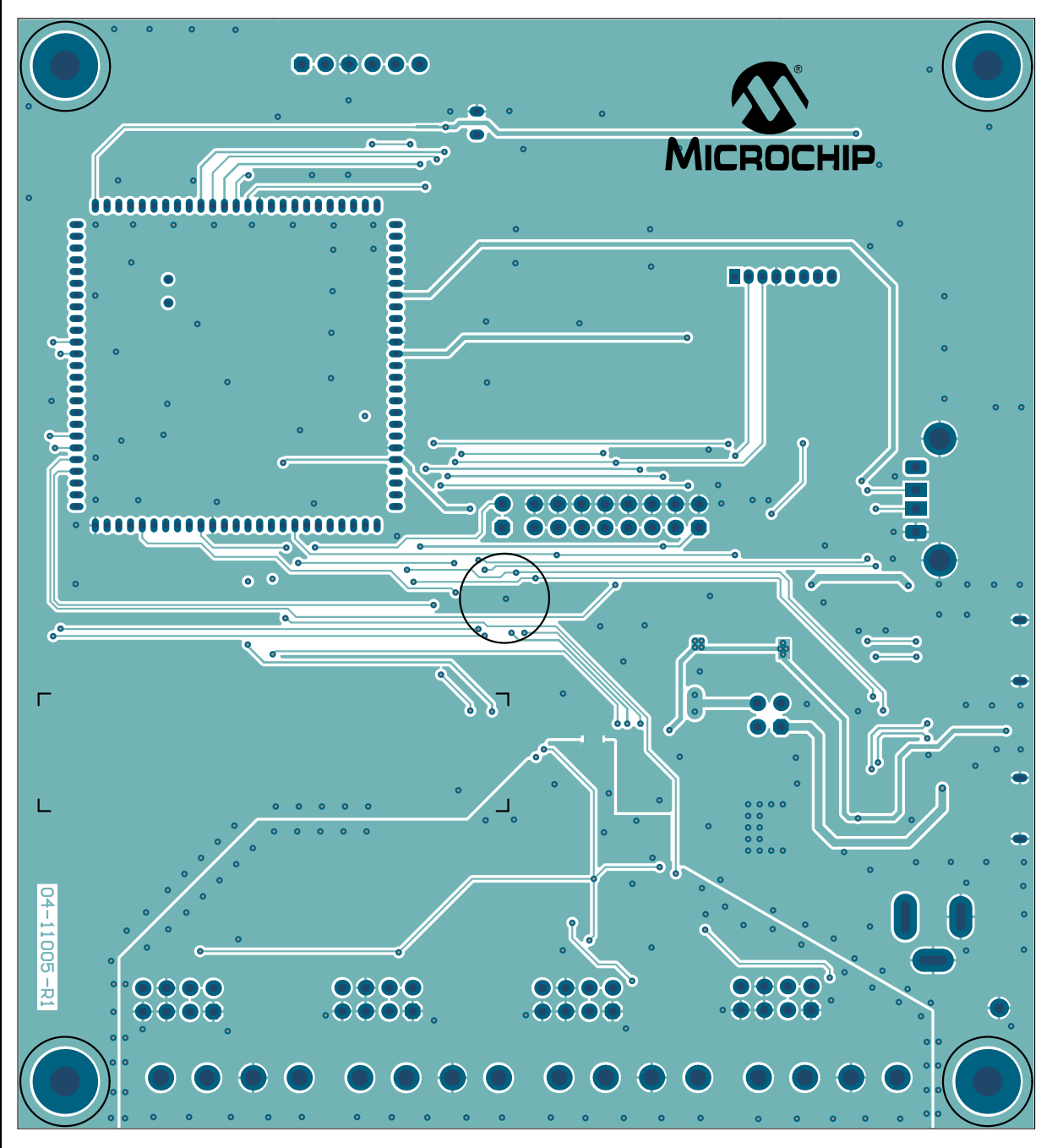

A.11 BOARD – BOTTOM SILK

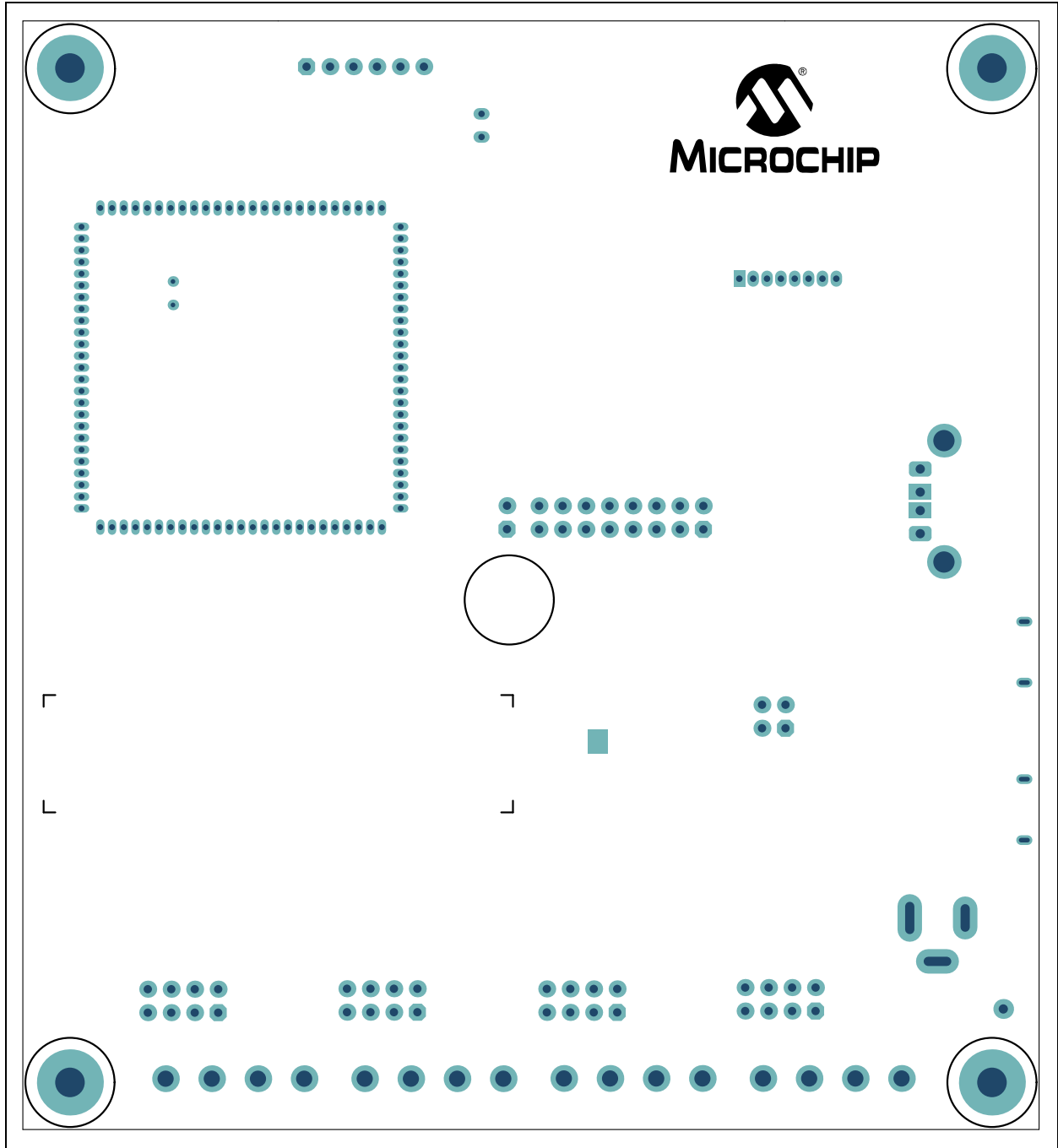

NOTES:

Appendix B. Bill of Materials (BOM)

TABLE B-1: BILL OF MATERIALS (BOM)

Qty.	Reference	Description	Manufacturer	Part Number
2	C1, C53	Capacitor, Tantalum, 10 μ F, 20V, 10%, 2.1 Ω , Surface Mounted, (SMD), B	AVX Corporation	TAJB106K020RNJ
1	C2	Capacitor, Ceramic, 10 μ F, 10V, 20%, X7R, SMD, 1206	Wurth Elektronik	885012208018
41	C3, C6, C7, C8, C9, C10, C11, C12, C13, C14, C15, C16, C17, C18, C19, C20, C21, C22, C23, C24, C25, C26, C27, C28, C29, C30, C31, C32, C33, C34, C35, C37, C39, C40, C41, C42, C43, C44, C45, C46, C49	Capacitor, Ceramic, 0.1 μ F, 16V, 10%, X7R, SMD, 0603	Taiyo Yuden Co., Ltd.	EMK107B7104KA-T
4	C4, C5, C36, C38	Capacitor, Ceramic, 1 μ F, 10V, 20%, X7R, SMD, 0603	Samsung Electro-Mechanics America, Inc.	CL10B105KP8NNNC
1	C47	Capacitor, Ceramic, 10 μ F, 10V, 20%, X5R, SMD, 0603	Samsung Electro-Mechanics America, Inc.	CL10A106MP8NNNC
2	C48, C52	Capacitor, Ceramic, 18 pF, 50V, 5%, C0G, SMD, 0603	TDK Corporation	C1608C0G1H180J080AA
2	C50, C51	Capacitor, Ceramic, 12 pF, 50V, 5%, NP0, SMD, 0603	KEMET	C0603C120J5GACTU
1	D1	Diode, Rectifier, MRA4005, 1.1V, 1A, 600V, DO-214AC_SMA	ON Semiconductor®	MRA4005T3G
1	J1	Connector, Power, 2.5 mm, 5.5 mm, Switch Slotted, Through-Hole (TH), Right Angle (R/A)	Kycon, Inc.	KLDX-0202-B
1	J2	Connector, HDR-2.54, Male, 2x2, Tin, 5.84MH, TH, Vertical	Amphenol Information Communication & Commercial – Amphenol ICC (FCI)	67997-404HLF
4	J3, J4, J5, J6	Connector, Terminal, 5 mm, 1x4, Female, 12-26AWG, 18A, TH, R/A	Phoenix Contact GmbH & Co.	1935187
4	J7, J8, J9, J10	Connector, HDR-2.54, Male, 2x4, Tin, 5.84MH, TH, Vertical	Amphenol ICC (FCI)	67996-408HLF
1	J11	Connector, HDR-2.54, Male, 1x2, Gold, 5.84MH, TH, Vertical	Multicomp Inc.	SPC20481

Note: The components listed in this Bill of Materials are representative of the PCB assembly. The released BOM used in manufacturing uses all RoHS-compliant components.

MCP3564 ADC Evaluation Board V2 for PIC32 MCUs User's Guide

TABLE B-1: BILL OF MATERIALS (BOM)

Qty.	Reference	Description	Manufacturer	Part Number
1	J12	Connector, HDR-2.54, Male, 2x8, Tin, 5.84MH, TH, Vertical	Amphenol ICC (FCI)	67996-416HLF
1	J15	Connector, USB 2.0, Micro-B, Female, SMD, R/A	Amphenol ICC (FCI)	10118193-0001LF
4	J16, J17, J18, J19	Connector, HDR-1.27, Male, 1x25, Gold, 5.84MH, TH, Vertical	Samtec, Inc.	TMS-125-01-G-S
1	J20	Connector, HDR-2.54, Male, 1x6, Gold, 5.84MH, TH, R/A	Würth Elektronik	61300611021
4	JP1, JP2, JP3, JP4	Mechanical, Jumper, 2.54 mm, 1x2, Handle, Gold	TE Connectivity, Ltd.	881545-2
1	L1	Ferrite, 150R@100 MHz, 300 mA, SMD, 1806	Laird Technologies®	LI1806C151R-10
1	LCD1	Display, LCD, 16x2, Alpha, 3.3V, TH	Newhaven Display International, Inc.	NHD-C0216-CIZ-FSW-FBW-3V3
1	LD1	Diode, LED, Green, 2V, 30 mA, 35mcd, Clear, SMD, 0603	Lite-On®, Inc.	LTST-C191KGKT
1	LD2	Diode, LED, Bi Red Green, 1.95V, 2.1V, 30 mA, 0805	Kingbright Electronic Co., Ltd.	APHBM2012SURKCGKC
2	LD3, LD4	Diode, LED, Red, 2V, 30 mA, 2mcd, Clear, SMD, 0603	Lite-On, Inc.	LTST-C190EKT
5	PAD1, PAD2, PAD3, PAD4, PAD5	Mechanical, HW Rubber Pad, Cylindrical, D9.53H5.97	3M	SJ61A2
1	PCB	MCP3564 ADC Evaluation Board V2 – Printed Circuit Board	Microchip Technology Inc.	04-11005-R1
1	PIM1	PIC32 PIM	Microchip Technology Inc.	MA320003
19	R2, R7, R8, R9, R10, R11, R12, R13, R14, R24, R28, R29, R34, R35, R40, R41, R43, R44, R45	Resistor, Thick Film (TKF), 1 kΩ, 5%, 1/10W, SMD, 0603	Panasonic® - ECG	ERJ3GEYJ102V
1	R3	Resistor, TKF, 18R, 1%, 1/10W, 0603	Yageo Corporation	RC0603FR-0718RL
12	R4, R5, R6, R15, R17, R18, R19, R20, R21, R22, R23, R39	Resistor, TKF, 10R, 5%, 1/10W, SMD, 0603	Panasonic - ECG	ERJ3GEYJ100V
2	R16, R48	Resistor, TKF, 10 kΩ, 1%, 1/10W, SMD, 0603	Yageo Corporation	RC0603FR-0710KL
6	R25, R26, R31, R32, R33, R42	Resistor, TKF, 4.7 kΩ, 5%, 1/10W, SMD, 0603	Panasonic - ECG	ERJ3GEYJ472V
2	R27, R30	Resistor, TKF, 330R, 1%, 1/10W, SMD, 0402	KOA Speer Electronics, Inc.	RK73H1ETTP3300F
1	R36	Resistor, TKF, 150 kΩ, 1%, 1/8W, SMD, 0603	KOA Speer Electronics, Inc.	SG73S1JTDD1503F
2	R37, R38	Resistor, Thin Film (TF), 2.2 kΩ, 1%, 1/8W, SMD, 0603	Vishay Beyschlag	MCT06030C2201FP500
1	R49	Resistor, TKF, 0R, 1/10W, SMD, 0603	Stackpole Electronics, Inc.	RMCF0603ZT0R00

Note: The components listed in this Bill of Materials are representative of the PCB assembly. The released BOM used in manufacturing uses all RoHS-compliant components.

Bill of Materials (BOM)

TABLE B-1: BILL OF MATERIALS (BOM)

Qty.	Reference	Description	Manufacturer	Part Number
4	SW1, SW2, SW3, SW4	Switch, Tactile, SPST, 12V, 50 mA, SMD	C&K Components	PTS645SM43SMTR92LFS
1	TP1	Test Point, Multipurpose, Black	Keystone Electronics Corp.	5001
1	U1	Microchip Analog LDO, 5V, MIC39100-5.0WS, 3-Lead SOT-223	Microchip Technology Inc.	MIC39100-5.0WS
1	U2	Microchip Analog LDO, 3.3V, MCP1825ST-3302E/DB, 3-Lead SOT-223	Microchip Technology Inc.	MCP1825ST-3302E/DB
1	U3	Microchip Analog LDO, 3.3V, MCP1754ST-3302E/DB, 3-Lead SOT-223	Microchip Technology Inc.	MCP1754ST-3302E/DB
1	U4	Microchip Analog V _{REF} , 2.5V, MCP1501-25E/SN, 8-Lead SOIC	Microchip Technology Inc.	MCP1501-25E/SN
1	U5	Microchip Analog DigiPot, 1-Ch, 10k, MCP41010-I/SN, 8-Lead SOIC	Microchip Technology Inc.	MCP41010-I/SN
1	U6	Microchip Analog Delta-Sigma ADC, 24-Bit, MCP3564T-E/NC, 20-Lead UQFN	Microchip Technology Inc.	MCP3564T-E/NC
1	U7	IC Switcher, ADG839, 6-Lead SC-70	Analog Devices Inc.	ADG839YKSZ-REEL7
1	U8	Microchip Analog Op Amp, 1-Ch, 10 MHz, MCP6V91UT-E/LTYCT-ND, 5-Lead SC-70	Microchip Technology Inc.	MCP6V91UT-E/LTY
1	U9	Microchip Interface USB UART, MCP2200-I/SS, 20-Lead SSOP	Microchip Technology Inc.	MCP2200T-I/SS
1	X1	Resonator, 12 MHz, 0.1%, SMD, CSTCE-G	Murata Electronics®	CSTCE12M0G15L99-R0
1	X2	Crystal, 32.768 kHz, 12.5 pF, RAD, P1.1D3.1H8.2	ECS, Inc. International	ECS-.327-12.5-13X
1	X3	Crystal, 8 MHz, 18 pF, SMD, ABMM2	Abrakon® Corporation (LLC)	ABMM2-8.000MHZ-E2-T

Note: The components listed in this Bill of Materials are representative of the PCB assembly. The released BOM used in manufacturing uses all RoHS-compliant components.

TABLE B-2: BILL OF MATERIALS (BOM) – DO NOT POPULATE

Qty.	Reference	Description	Manufacturer	Part Number
0	J13	Connector, USB 2.0, Micro-B, Female, SMD, R/A	Amphenol ICC (FCI)	10118193-0001LF
0	J14	Connector, USB 2.0, STD-A, Female, TH, R/A	TE Connectivity AMP Connectors	292303-1
0	R50	Resistor, TKF, 10R, 5%, 1/10W, SMD, 0603	Panasonic Electronic Components	ERJ3GEYJ100V

Note: The components listed in this Bill of Materials are representative of the PCB assembly. The released BOM used in manufacturing uses all RoHS-compliant components.



MICROCHIP

Worldwide Sales and Service

AMERICAS

Corporate Office
2355 West Chandler Blvd.
Chandler, AZ 85224-6199
Tel: 480-792-7200
Fax: 480-792-7277
Technical Support:
<http://www.microchip.com/support>
Web Address:
www.microchip.com

Atlanta

Duluth, GA
Tel: 678-957-9614
Fax: 678-957-1455

Austin, TX

Tel: 512-257-3370

Boston

Westborough, MA
Tel: 774-760-0087
Fax: 774-760-0088

Chicago

Itasca, IL
Tel: 630-285-0071
Fax: 630-285-0075

Dallas

Addison, TX
Tel: 972-818-7423
Fax: 972-818-2924

Detroit

Novi, MI
Tel: 248-848-4000

Houston, TX

Tel: 281-894-5983

Indianapolis

Noblesville, IN
Tel: 317-773-8323
Fax: 317-773-5453
Tel: 317-536-2380

Los Angeles

Mission Viejo, CA
Tel: 949-462-9523
Fax: 949-462-9608
Tel: 951-273-7800

Raleigh, NC

Tel: 919-844-7510

New York, NY

Tel: 631-435-6000

San Jose, CA

Tel: 408-735-9110
Tel: 408-436-4270

Canada - Toronto

Tel: 905-695-1980
Fax: 905-695-2078

ASIA/PACIFIC

Australia - Sydney
Tel: 61-2-9868-6733

China - Beijing
Tel: 86-10-8569-7000

China - Chengdu
Tel: 86-28-8665-5511

China - Chongqing
Tel: 86-23-8980-9588

China - Dongguan
Tel: 86-769-8702-9880

China - Guangzhou
Tel: 86-20-8755-8029

China - Hangzhou
Tel: 86-571-8792-8115

China - Hong Kong SAR
Tel: 852-2943-5100

China - Nanjing
Tel: 86-25-8473-2460

China - Qingdao
Tel: 86-532-8502-7355

China - Shanghai
Tel: 86-21-3326-8000

China - Shenyang
Tel: 86-24-2334-2829

China - Shenzhen
Tel: 86-755-8864-2200

China - Suzhou
Tel: 86-186-6233-1526

China - Wuhan
Tel: 86-27-5980-5300

China - Xian
Tel: 86-29-8833-7252

China - Xiamen
Tel: 86-592-2388138

China - Zhuhai
Tel: 86-756-3210040

ASIA/PACIFIC

India - Bangalore
Tel: 91-80-3090-4444

India - New Delhi
Tel: 91-11-4160-8631

India - Pune
Tel: 91-20-4121-0141

Japan - Osaka
Tel: 81-6-6152-7160

Japan - Tokyo
Tel: 81-3-6880-3770

Korea - Daegu
Tel: 82-53-744-4301

Korea - Seoul
Tel: 82-2-554-7200

Malaysia - Kuala Lumpur
Tel: 60-3-7651-7906

Malaysia - Penang
Tel: 60-4-227-8870

Philippines - Manila
Tel: 63-2-634-9065

Singapore
Tel: 65-6334-8870

Taiwan - Hsin Chu
Tel: 886-3-577-8366

Taiwan - Kaohsiung
Tel: 886-7-213-7830

Taiwan - Taipei
Tel: 886-2-2508-8600

Thailand - Bangkok
Tel: 66-2-694-1351

Vietnam - Ho Chi Minh
Tel: 84-28-5448-2100

EUROPE

Austria - Wels
Tel: 43-7242-2244-39
Fax: 43-7242-2244-393

Denmark - Copenhagen
Tel: 45-4450-2828
Fax: 45-4485-2829

Finland - Espoo
Tel: 358-9-4520-820

France - Paris
Tel: 33-1-69-53-63-20
Fax: 33-1-69-30-90-79

Germany - Garching
Tel: 49-8931-9700

Germany - Haan
Tel: 49-2129-3766400

Germany - Heilbronn
Tel: 49-7131-72400

Germany - Karlsruhe
Tel: 49-721-625370

Germany - Munich
Tel: 49-89-627-144-0
Fax: 49-89-627-144-44

Germany - Rosenheim
Tel: 49-8031-354-560

Israel - Ra'anana
Tel: 972-9-744-7705

Italy - Milan
Tel: 39-0331-742611
Fax: 39-0331-466781

Italy - Padova
Tel: 39-049-7625286

Netherlands - Drunen
Tel: 31-416-690399
Fax: 31-416-690340

Norway - Trondheim
Tel: 47-7288-4388

Poland - Warsaw
Tel: 48-22-3325737

Romania - Bucharest
Tel: 40-21-407-87-50

Spain - Madrid
Tel: 34-91-708-08-90
Fax: 34-91-708-08-91

Sweden - Gothenberg
Tel: 46-31-704-60-40

Sweden - Stockholm
Tel: 46-8-5090-4654

UK - Wokingham
Tel: 44-118-921-5800
Fax: 44-118-921-5820

Mouser Electronics

Authorized Distributor

Click to View Pricing, Inventory, Delivery & Lifecycle Information:

[Microchip:](#)

[ADM01097](#)