

## Preface

The Atmel® SAM4L8 Xplained Pro evaluation kit is hardware platform to evaluate the ATSAM4LC8CA microcontroller.

Supported by the Atmel Studio integrated development platform, the kit provides easy access to the features of the Atmel ATSAM4LC8CA and explains how to integrate the device in a customer design.

The Xplained Pro MCU series evaluation kits include an on-board Embedded Debugger, and no external tools are necessary to program or debug the ATSAM4LC8CA.

The Xplained Pro extension series evaluation kits offers additional peripherals to extend the features of the board and ease the development of customer designs.

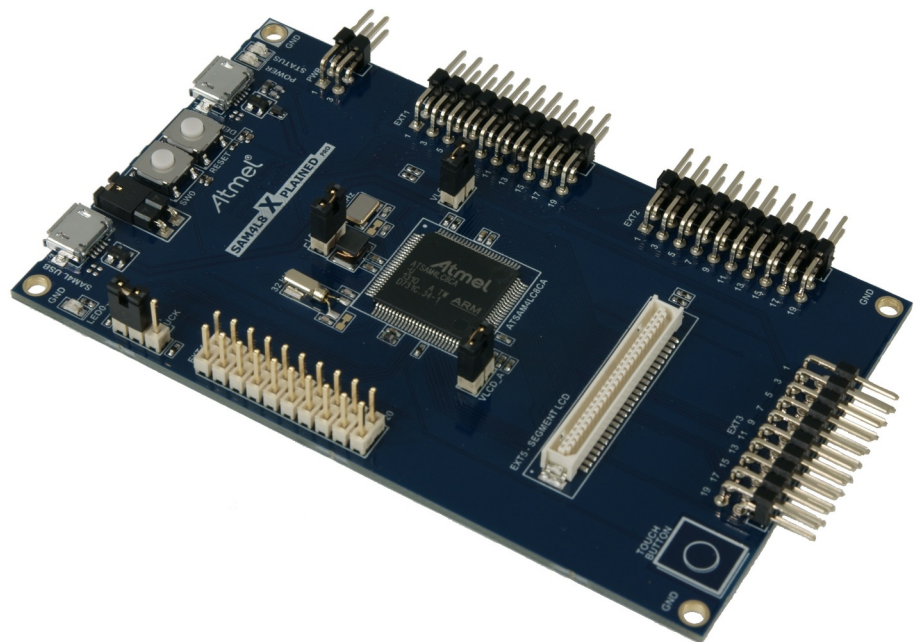

# Table of Contents

---

Preface.....	1
1. Introduction.....	4
1.1. Features.....	4
1.2. Kit Overview.....	4
2. Getting Started.....	7
2.1. Xplained Pro Quick Start.....	7
2.2. Design Documentation and Relevant Links.....	7
3. Xplained Pro.....	9
3.1. Embedded Debugger.....	9
3.2. Hardware Identification System.....	10
3.3. Power Sources.....	10
3.4. Xplained Pro Headers and Connectors.....	11
3.4.1. Xplained Pro Standard Extension Header.....	11
3.4.2. Xplained Pro Segment LCD Connector.....	12
3.4.3. Xplained Pro Power Header.....	13
4. Hardware User Guide.....	14
4.1. Connectors.....	14
4.1.1. Xplained Pro Standard Extension Headers.....	14
4.1.2. Segment LCD Extension Connector.....	17
4.1.3. Current Measurement Header.....	19
4.2. Peripherals.....	19
4.2.1. QTouch Button.....	19
4.2.2. Crystals.....	19
4.2.3. Mechanical Buttons.....	19
4.2.4. LED.....	20
4.3. Embedded Debugger Implementation.....	20
4.3.1. Serial Wire Debug.....	20
4.3.2. Virtual COM Port.....	20
4.3.3. Atmel Data Gateway Interface.....	20
4.4. Jumper Description.....	21
4.4.1. LDO/BUCK Jumper.....	21
4.4.2. LDO Jumper.....	21
4.4.3. VLCD_A and VLCD_BC Jumpers.....	21
4.4.4. VCC_MCU Jumper.....	22
5. Hardware Revision History and Known Issues.....	23
5.1. Identifying Product ID and Revision.....	23
5.2. Revision 1.....	23
6. Appendix.....	24
6.1. Getting Started with IAR.....	24

7. Document Revision History.....	27
8. Evaluation Board/Kit Important Notice.....	28

# 1. Introduction

## 1.1. Features

- Atmel ATSAM4LC8CA microcontroller
- Embedded debugger (EDBG)
  - USB interface
  - Programming and debugging (target) through Serial Wire Debug (SWD)
  - Virtual COM-port interface to target via UART
  - Atmel Data Gateway interface (DGI) to target via synchronous UART or TWI
  - Four GPIOs connected to target for code instrumentation
- Digital I/O
  - Two mechanical buttons (including one reset button)
  - One user LED
  - Four extension headers
- Segment LCD display header
- USB interface for host and device function (target)
- Touch
  - One Atmel QTouch<sup>®</sup> button
- Three possible power sources
  - External power
  - Embedded debugger USB
  - Target USB
- 12MHz crystal
- 32kHz crystal

## 1.2. Kit Overview

The Atmel SAM4L8 Xplained Pro evaluation kit is a hardware platform to evaluate the Atmel ATSAM4LC8CA.

The kit offers a set of features that enables the SAM4L8 user to get started using the SAM4L8's peripherals right away and to get an understanding of how to integrate the SAM4L8 in their own design.

Figure 1-1. SAM4L8 Xplained Pro Evaluation Kit Overview

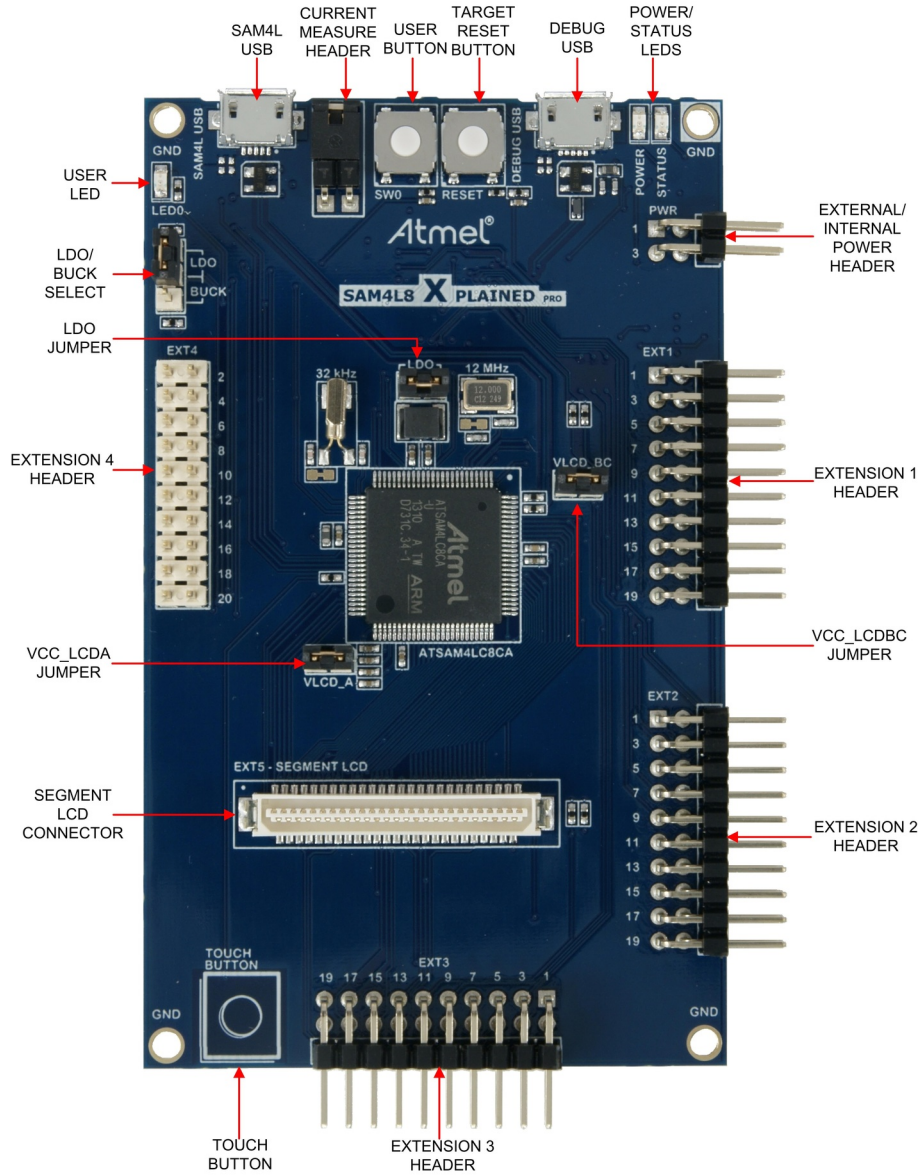
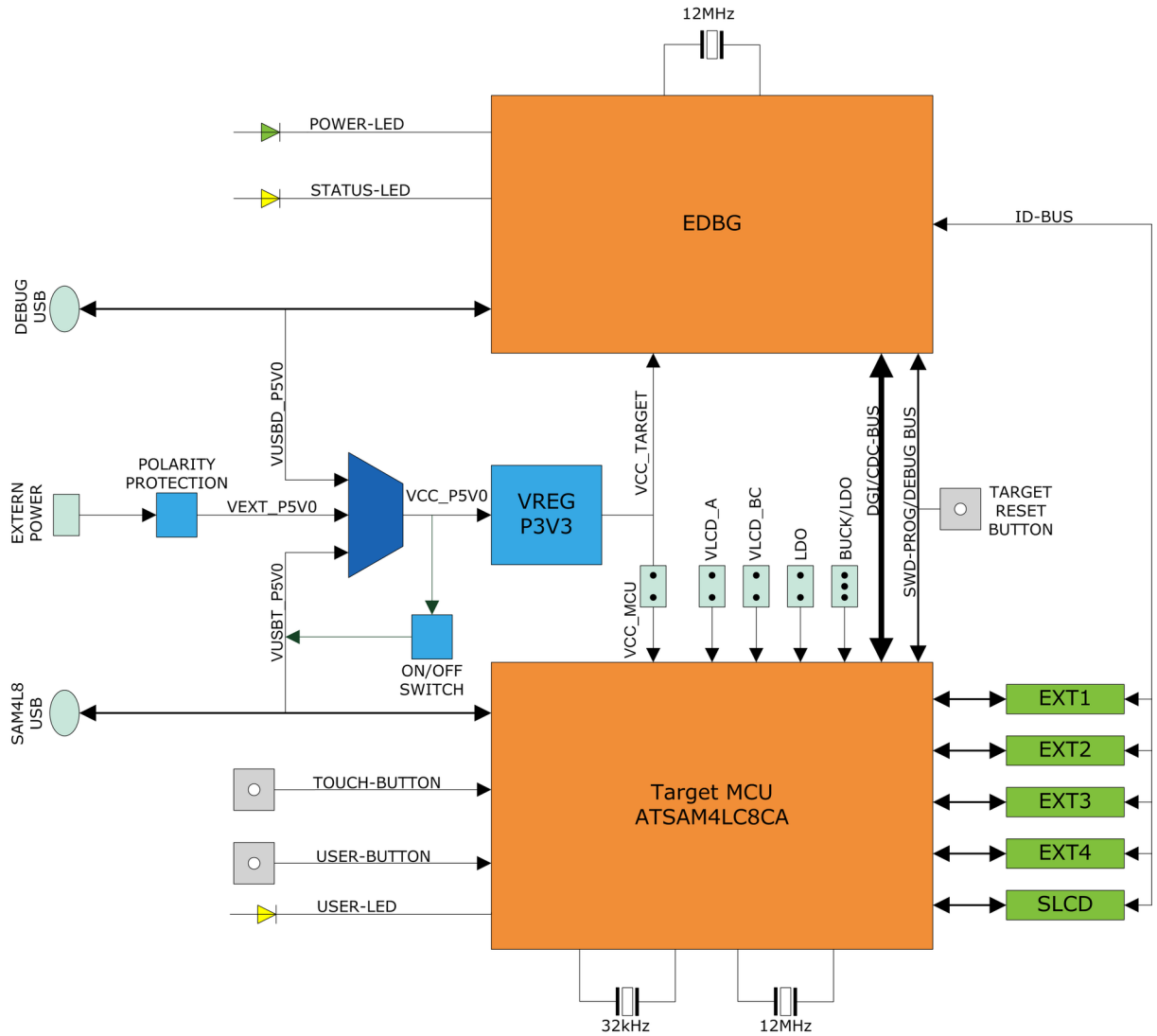

Figure 1-2. SAM4L8 Xplained Pro Block Diagram



## 2. Getting Started

### 2.1. Xplained Pro Quick Start

Steps to start exploring the Atmel Xplained Pro platform:

1. Download [Atmel Studio](#).
2. Launch Atmel Studio.
3. Connect a USB cable (Standard-A to Micro-B or Micro-AB) between the PC and the DEBUG USB port on the kit.

When the Xplained Pro MCU kit is connected to your computer for the first time, the operating system will perform a driver software installation. The driver file supports both 32- and 64-bit versions of Microsoft® Windows® XP, Windows Vista®, Windows 7, Windows 8, Windows 10, and Windows Server 2012.

Once the Xplained Pro MCU board is powered the green power LED will be lit and Atmel Studio will auto detect which Xplained Pro MCU- and extension board(s) are connected. Atmel Studio will present relevant information like datasheets and kit documentation. The kit landing page in Atmel Studio also has the option to launch Atmel Software Framework (ASF) example applications for the kit. The SAM4L8 device is programmed and debugged by the on-board Embedded Debugger and therefore no external programmer or debugger tool is needed.

### 2.2. Design Documentation and Relevant Links

The following list contains links to the most relevant documents and software for the SAM4L8 Xplained Pro.

- [Xplained products](#) - Atmel Xplained evaluation kits are a series of easy-to-use evaluation kits for Atmel microcontrollers and other Atmel products. For low pin-count devices the Xplained Nano series provides a minimalistic solution with access to all I/O pins of the target microcontroller. Xplained Mini kits are for medium pin-count devices and adds Arduino Uno compatible header footprint and a prototyping area. Xplained Pro kits are for medium to high pin-count devices, they features advanced debugging and standardized extensions for peripheral functions. All these kits have on board programmers/debuggers which creates a set of low-cost boards for evaluation and demonstration of features and capabilities of different Atmel products.
- [Atmel Studio](#) - Free Atmel IDE for development of C/C++ and assembler code for Atmel microcontrollers.
- [Atmel sample store](#) - Atmel sample store where you can order samples of devices.
- [EDBG User Guide](#) - User guide containing more information about the on-board Embedded Debugger.
- [IAR Embedded Workbench® for ARM®](#) - This is a commercial C/C++ compiler that is available for ARM®. There is a 30 day evaluation version as well as a code size limited kick-start version available from their website. The code size limit is 16KB for devices with M0, M0+, and M1 cores and 32KB for devices with other cores.
- [Atmel QTouch® Library PTC](#) - QTouch Library for Atmel AVR® and ARM®-based microcontrollers.
- [Atmel QTouch® Composer](#) - Tool for developing capacitive buttons, sliders, and wheels applications.
- [Atmel Data Visualizer](#) - Atmel Data Visualizer is a program used for processing and visualizing data. Data Visualizer can receive data from various sources such as the Embedded Debugger Data Gateway Interface found on Xplained Pro boards and COM ports.

- [Segment LCD1 Xplained Pro](#) - Segment LCD1 Xplained Pro is a segment LCD Xplained Pro extension with 96 segments that uses four COM and 24 SEG signals. An Xplained Pro MCU board with a Xplained Pro segment LCD connector is required to use the kit.
- [Hardware Users Guide in PDF format](#) - PDF version of this User Guide.
- [Design Documentation](#) - Package containing CAD source, schematics, BOM, assembly drawings, 3D plots, layer plots etc.
- [SAM4L8 Xplained Pro on the Atmel website](#) - Atmel website link.



### 3. Xplained Pro

Xplained Pro is an evaluation platform that provides the full Atmel microcontroller experience. The platform consists of a series of Microcontroller (MCU) boards and extension boards, which are integrated with Atmel Studio, have Atmel Software Framework (ASF) drivers and demo code, support data streaming, and more. Xplained Pro MCU boards support a wide range of Xplained Pro extension boards, which are connected through a set of standardized headers and connectors. Each extension board has an identification (ID) chip to uniquely identify which boards are connected to an Xplained Pro MCU board. This information is used to present relevant user guides, application notes, datasheets, and example code through Atmel Studio.

#### 3.1. Embedded Debugger

The SAM4L8 Xplained Pro contains the Atmel Embedded Debugger (EDBG) for on-board debugging. The EDBG is a composite USB device of three interfaces; a debugger, Virtual COM Port, and a Data Gateway Interface (DGI).

Together with Atmel Studio, the EDBG debugger interface can program and debug the ATSAM4LC8CA. On SAM4L8 Xplained Pro, the SWD interface is connected between the EDBG and the ATSAM4LC8CA.

The Virtual COM Port is connected to a UART on the ATSAM4LC8CA and provides an easy way to communicate with the target application through terminal software. It offers variable baud rate, parity, and stop bit settings. Note that the settings on the ATSAM4LC8CA must match the settings given in the terminal software.



**Info:** The virtual COM port in the EDBG requires the terminal software to set the data terminal ready (DTR) signal to enable the UART pins connected to the ATSAM4LC8CA. If the DTR signal is not enabled the UART pins on the EDBG is kept in high-z (tristate) rendering the COM port unusable. The DTR signal is set automatically by some terminal software, but it may have to be manually enabled in your terminal.

The DGI consists of several physical interfaces for communication with the host computer. Communication over the interfaces is bidirectional. It can be used to send events and values from the ATSAM4LC8CA or as a generic printf-style data channel. Traffic over the interfaces can be timestamped on the EDBG for more accurate tracing of events. Note that timestamping imposes an overhead that reduces maximal throughput. [Atmel Data Visualizer](#) is used to send and receive data through DGI.

The EDBG controls two LEDs on SAM4L8 Xplained Pro; a power LED and a status LED. The table below shows how the LEDs are controlled in different operation modes.

**Table 3-1. EDBG LED Control**

Operation mode	Power LED	Status LED
Normal operation	Power LED is lit when power is applied to the board.	Activity indicator, LED flashes when any communication happens to the EDBG.
Bootloader mode (idle)	The power LED and the status LED blinks simultaneously.	
Bootloader mode (firmware upgrade)	The power LED and the status LED blinks in an alternating pattern.	

For further documentation on the EDBG, see the [EDBG User Guide](#).

### 3.2. Hardware Identification System

All Xplained Pro compatible extension boards have an Atmel ATSHA204 CryptoAuthentication™ chip mounted. This chip contains information that identifies the extension with its name and some extra data. When an Xplained Pro extension is connected to an Xplained Pro MCU board the information is read and sent to Atmel Studio. The Atmel Kits extension, installed with Atmel Studio, will give relevant information, code examples, and links to relevant documents. The table below shows the data fields stored in the ID chip with example content.

**Table 3-2. Xplained Pro ID Chip Content**

Data field	Data type	Example content
Manufacturer	ASCII string	Atmel'\0'
Product Name	ASCII string	Segment LCD1 Xplained Pro'\0'
Product Revision	ASCII string	02'\0'
Product Serial Number	ASCII string	1774020200000010'\0'
Minimum Voltage [mV]	uint16_t	3000
Maximum Voltage [mV]	uint16_t	3600
Maximum Current [mA]	uint16_t	30

### 3.3. Power Sources

The SAM4L8 Xplained Pro kit can be powered by several power sources as listed in the table below.

**Table 3-3. Power Sources for SAM4L8 Xplained Pro**

Power input	Voltage requirements	Current requirements	Connector marking
External power	5V $\pm$ 2% ( $\pm$ 100mV) for USB host operation. 4.3V to 5.5V if USB host operation is not required.	Recommended minimum is 1A to be able to provide enough current for connected USB devices and the board itself. Recommended maximum is 2A due to the input protection maximum current specification.	PWR
Embedded debugger USB	4.4V to 5.25V (according to USB spec.)	500mA (according to USB spec.)	DEBUG USB
Target USB	4.4V to 5.25V (according to USB spec.)	500mA (according to USB spec.)	TARGET USB

The kit will automatically detect which power sources are available and choose which one to use according to the following priority:

1. External power.
2. Embedded Debugger USB.
3. Target USB.



**Info:** External power is required when 500mA from a USB connector is not enough to power the board with possible extension boards. A connected USB device in a USB host application might easily exceed this limit.

## 3.4. Xplained Pro Headers and Connectors

### 3.4.1. Xplained Pro Standard Extension Header

All Xplained Pro kits have one or more dual row, 20-pin, 100mil extension header. Xplained Pro MCU boards have male headers, while Xplained Pro extensions have their female counterparts. Note that all pins are not always connected. All connected pins follow the defined pin-out description in the table below.

The extension headers can be used to connect a variety of Xplained Pro extensions to Xplained Pro MCU boards or to access the pins of the target MCU on Xplained Pro MCU boards directly.

**Table 3-4. Xplained Pro Standard Extension Header**

Pin number	Name	Description
1	ID	Communication line to the ID chip on an extension board
2	GND	Ground
3	ADC(+)	Analog to digital converter, alternatively positive part of differential ADC
4	ADC(-)	Analog to digital converter, alternatively negative part of differential ADC
5	GPIO1	General purpose I/O
6	GPIO2	General purpose I/O
7	PWM(+)	Pulse width modulation, alternatively positive part of differential PWM
8	PWM(-)	Pulse width modulation, alternatively negative part of differential PWM
9	IRQ/GPIO	Interrupt request line and/or general purpose I/O
10	SPI_SS_B/ GPIO	Slave select for SPI and/or general purpose I/O
11	I <sup>2</sup> C_SDA	Data line for I <sup>2</sup> C interface. Always implemented, bus type.
12	I <sup>2</sup> C_SCL	Clock line for I <sup>2</sup> C interface. Always implemented, bus type.
13	UART_RX	Receiver line of target device UART
14	UART_TX	Transmitter line of target device UART

Pin number	Name	Description
15	SPI_SS_A	Slave select for SPI. Should preferably be unique.
16	SPI_MOSI	Master out slave in line of serial peripheral interface. Always implemented, bus type.
17	SPI_MISO	Master in slave out line of serial peripheral interface. Always implemented, bus type.
18	SPI_SCK	Clock for serial peripheral interface. Always implemented, bus type.
19	GND	Ground
20	VCC	Power for extension board

### 3.4.2. Xplained Pro Segment LCD Connector

Xplained Pro MCU boards that have a microcontroller, which supports segment LCDs, can implement a 51-pin segment LCD extension connector. This connector is implemented with HIROSE DF-9 series. Xplained Pro MCU boards use the male version DF9-51P-1V(69) and Xplained Pro extension boards use the female counterpart DF9-51S-1V(69). The connector has a standardized pin-out as shown in the table below.



#### Info:

All pins are not connected on all Xplained Pro MCU boards, it depends on how many segments and common terminals the target MCU supports.

Pin 37, 38, 39, 40, 41, and 42 can alternatively be used for QTouch signals. When they are used for touch they should not be used for display segments.

**Table 3-5. Xplained Pro Segment LCD Connector**

Description	Function	Pin	Pin	Function	Description
Common terminal 3	COM3	1	2	COM2	Common terminal 2
Common terminal 1	COM1	3	4	COM0	Common terminal 0
Segment 0	SEG0	5	6	SEG1	Segment 1
Segment 2	SEG2	7	8	SEG3	Segment 3
Segment 4	SEG4	9	10	SEG5	Segment 5
Segment 6	SEG6	11	12	SEG7	Segment 7
Segment 8	SEG8	13	14	SEG9	Segment 9
Segment 10	SEG10	15	16	SEG11	Segment 11
Segment 12	SEG12	17	18	SEG13	Segment 13
Segment 14	SEG14	19	20	SEG15	Segment 15
Segment 16	SEG16	21	22	SEG17	Segment 17
Segment 18	SEG18	23	24	SEG19	Segment 19
Segment 20	SEG20	25	26	SEG21	Segment 21

Description	Function	Pin	Pin	Function	Description
Segment 22	SEG22	27	28	SEG23	Segment 23
Segment 24	SEG24	29	30	SEG25	Segment 25
Segment 26	SEG26	31	32	SEG27	Segment 27
Segment 28	SEG28	33	34	SEG29	Segment 29
Segment 30	SEG30	35	36	SEG31	Segment 31
Segment 32 / QTouch X-line 2	SEG32 / QT_X2	37	38	SEG33 / QT_Y2	Segment 33 / QTouch Y-line 2
Segment 34 / QTouch X-line 1	SEG34 / QT_X1	39	40	SEG35 / QT_Y1	Segment 35 / QTouch Y-line 1
Segment 36 / QTouch X-line 0	SEG36 / QT_X0	41	42	SEG37 / QT_Y0	Segment 37 / QTouch Y-line 0
Common terminal 4	COM4	43	44	COM5	Common terminal 5
Common terminal 6	COM6	45	46	COM7	Common terminal 6
Backlight anode	Backlight V+	47	48	Backlight V-	Backlight cathode
Backlight control	Backlight CTRL	49	50	ID	Xplained Pro ID
Ground	GND	51			

### 3.4.3. Xplained Pro Power Header

The power header can be used to connect external power to the SAM4L8 Xplained Pro kit. The kit will automatically detect and switch to any external power if supplied. The power header can also be used as supply for external peripherals or extension boards. Care must be taken not to exceed the total current limitation of the on-board regulator when using the 3.3V pin.

**Table 3-6. Xplained Pro Power Header**

Pin number	Pin name	Description
1	VEXT_P5V0	External 5V input
2	GND	Ground
3	VCC_P5V0	Unregulated 5V (output, derived from one of the input sources)
4	VCC_P3V3	Regulated 3.3V (output, used as main power supply for the kit)

## 4. Hardware User Guide

### 4.1. Connectors

This chapter describes the implementation of the relevant connectors and headers on SAM4L8 Xplained Pro and their connection to the ATSAM4LC8CA. The tables of connections in this chapter also describes which signals are shared between the headers and on-board functionality.

#### 4.1.1. Xplained Pro Standard Extension Headers

The SAM4L8 Xplained Pro headers EXT1, EXT2, EXT3, and EXT4 offers access to the I/O of the microcontroller in order to expand the board e.g. by connecting extensions to the board. These headers all comply with the standard Xplained Pro extension header specification. All headers have a pitch of 2.54mm.

**Table 4-1. Extension Header EXT1**

Pin on EXT1	SAM4L8 pin	Function	Shared functionality
1	-	-	Communication line to ID chip on extension board
2	-	-	GND
3	PA04	ADCIFE/AD[0]	
4	PA05	ADCIFE/AD[1]	
5	PB12	GPIO	LCD connector (EXT5)
6	PC02	GPIO	
7	PC00	TC/1/A0	
8	PC01	TC/1/B0	
9	PC25	EIC/EXTINT[2]	LCD connector (EXT5)
10	PB13	SPI/NPCS[1]	LCD connector (EXT5)
11	PA23	TWIMS/0/TWD	LCD connector (EXT5)
12	PA24	TWIMS/0/TWCK	LCD connector (EXT5)
13	PB00	USART/0/RXD	EXT4
14	PB01	USART/0/TXD	EXT4
15	PC03	SPI/NPCS[0]	
16	PA22	SPI/MOSI	EXT2 and LCD connector (EXT5)
17	PA21	SPI/MISO	EXT2 and LCD connector (EXT5)
18	PC30	SPI/SCK	EXT2 and LCD connector (EXT5)
19	-	-	GND
20	-	-	VCC

**Table 4-2. Extension Header EXT2**

Pin on EXT2	SAM4L8 pin	Function	Shared functionality
1	-	-	Communication line to ID chip on extension board
2	-	-	GND
3	PA07	ADCIFE/AD[2]	
4	PB02	ADCIFE/AD[3]	
5	PC08	GPIO	
6	PB10	GPIO	LCD connector (EXT5)
7	PC04	TC/1/A2	
8	PC05	TC/1/B2	LCD connector (EXT5)
9	PC06	EIC/EXTINT[8]	
10	PC09	GPIO	
11	PB14	TWIMS/3/TWD	EXT3, EXT4, and LCD connector (EXT5)
12	PB15	TWIMS/3/TWCK	EXT3, EXT4, and LCD connector (EXT5)
13	PC26	USART/1/RXD	EXT3 and LCD connector (EXT5)
14	PC27	USART/1/TXD	EXT3 and LCD connector (EXT5)
15	PB11	SPI/NPCS[2]	LCD connector (EXT5)
16	PA22	SPI/MOSI	EXT1 and LCD connector (EXT5)
17	PA21	SPI/MISO	EXT1 and LCD connector (EXT5)
18	PC30	SPI/SCK	EXT1 and LCD connector (EXT5)
19	-	-	GND
20	-	-	VCC

**Table 4-3. Extension Header EXT3**

Pin on EXT3	SAM4L8 pin	Function	Shared functionality
1	-	-	Communication line to ID chip on extension board
2	-	-	GND
3	PB03	ADCIFE/AD[4]	
4	PB04	ADCIFE/AD[5]	
5	PC15	GPIO	LCD connector (EXT5)
6	PC16	GPIO	LCD connector (EXT5)
7	PA08	TC/0/A0	LCD connector (EXT5)

Pin on EXT3	SAM4L8 pin	Function	Shared functionality
8	PA09	TC/0/B0	LCD connector (EXT5)
9	PA06	EIC/EXTINT[1]	
10	PA10	GPIO	LCD connector (EXT5)
11	PB14	TWIMS/3/TWD	EXT2, EXT4, and LCD connector (EXT5)
12	PB15	TWIMS/3/TWCK	EXT2, EXT4, and LCD connector (EXT5)
13	PC26	USART/1/RXD	EXT2 and LCD connector (EXT5)
14	PC27	USART/1/TXD	EXT2 and LCD connector (EXT5)
15	PA17	GPIO	LCD connector (EXT5)
16	PA20	UART/2/TXD	EXT4 and LCD connector (EXT5)
17	PA19	UART/2/RXD	EXT4 and LCD connector (EXT5)
18	PA18	UART/2/CLK	EXT4 and LCD connector (EXT5)
19	-	-	GND
20	-	-	VCC

**Table 4-4. Extension Header EXT4**

Pin on EXT4	SAM4L8 pin	Function	Shared functionality
1	-	-	Communication line to ID chip on extension board
2	-	-	GND
3	PB05	ADCIFE/AD[6]	
4	PC10	ADCIFE/AD[7]	USB_ID
5	PC17	GPIO	LCD connector (EXT5)
6	PC18	GPIO	LCD connector (EXT5)
7	PA12	TC/0/A2	LCD connector (EXT5)
8	PA13	TC/0/B2	LCD connector (EXT5)
9	PA16	GPIO	LCD connector (EXT5)
10	PA15	GPIO	LCD connector (EXT5)
11	PB14	TWIMS/3/TWD	EXT2, EXT3, and LCD connector (EXT5)
12	PB15	TWIMS/3/TWCK	EXT2, EXT3, and LCD connector (EXT5)
13	PB00	USART/0/RXD	EXT1
14	PB01	USART/0/TXD	EXT1



Pin on EXT4	SAM4L8 pin	Function	Shared functionality
15	PA11	GPIO	LCD connector (EXT5)
16	PA20	UART/2/TXD	EXT3 and LCD connector (EXT5)
17	PA19	UART/2/RXD	EXT3 and LCD connector (EXT5)
18	PA18	UART/2/CLK	EXT3 and LCD connector (EXT5)
19	-	-	GND
20	-	-	VCC

#### 4.1.2. Segment LCD Extension Connector

Extension connector EXT5 is a special connector for segment LCD displays. SAM4L8 Xplained Pro implements one Xplained Pro Segment LCD connector for Xplained Pro extensions.

**Table 4-5. Segment LCD Connector EXT5**

Pin on EXT5	SAM4L8 pin	Function	Shared functionality
1	PA09	COM3	EXT3
2	PA10	COM2	EXT3
3	PA11	COM1	EXT4
4	PA12	COM0	EXT4
5	PC15	SEG0	EXT3
6	PC16	SEG1	EXT3
7	PC17	SEG2	EXT4
8	PC18	SEG3	EXT4
9	PC19	SEG4	
10	PA13	SEG5	EXT4
11	PA14	SEG6	
12	PA15	SEG7	EXT4
13	PA16	SEG8	EXT4
14	PA17	SEG9	EXT3
15	PC20	SEG10	
16	PC21	SEG11	
17	PC22	SEG12	
18	PC23	SEG13	
19	PB08	SEG14	
20	PB09	SEG15	
21	PB10	SEG16	EXT2
22	PB11	SEG17	EXT2

Pin on EXT5	SAM4L8 pin	Function	Shared functionality
23	PA18	SEG18	EXT3 and EXT4
24	PA19	SEG19	EXT3 and EXT4
25	PA20	SEG20	EXT3 and EXT4
26	PB07	SEG21	
27	PB06	SEG22	
28	PA08	SEG23	EXT3
29	PC24	SEG24	
30	PC25	SEG25	EXT1
31	PC26	SEG26	EXT2 and EXT3
32	PC27	SEG27	EXT2 and EXT3
33	PC28	SEG28	
34	PC29	SEG29	
35	PC30	SEG30	EXT1 and EXT2
36	PC31	SEG31	
37	PB12	SEG32	EXT1
38	PB13	SEG33	EXT1
39	PA21	SEG34	EXT1 and EXT2
40	PA22	SEG35	EXT1 and EXT2
41	PB14	SEG36	EXT2, EXT3, and EXT4
42	PB15	SEG37	EXT2, EXT3, and EXT4
43	PA23	SEG38	EXT1
44	PA24	SEG39	EXT1
45	-	Not Connected	
46	-	Not Connected	
47	-	VCC_P3V3	
48	-	GND	
49	PC05	Backlight	EXT2
50	-	ID	
51	-	GND	

#### Related Links

[Xplained Pro Segment LCD Connector](#) on page 12

### 4.1.3. Current Measurement Header

An angled 1x2, 100mil pin-header marked with MCU current measurement is located at the upper edge of the SAM4L8 Xplained Pro. All power to the ATSAM4LC8CA is routed through this header. To measure the power consumption of the device remove the jumper and replace it with an ammeter.



**Caution:** Removing the jumper from the pin-header while the kit is powered may cause the ATSAM4LC8CA to be powered through its I/O pins. This may cause permanent damage to the device.

## 4.2. Peripherals

### 4.2.1. QTouch Button

The SAM4L8 Xplained Pro kit has one QTouch button and the connection to the SAM4L8 is shown in the table below. The QTouch sensor, a copper fill, is located on the second layer (GND) of the board. The sensor is shielded by the third and the bottom layer (VCC and signal layer respectively) and therefore the sensor is not affected by any touches from the back side of the board.

**Table 4-6. QTouch Button Connections**

Pin on SAM4L8	Function
PC13	CATB_SENSE15
PC14	CATB_DIS

### 4.2.2. Crystals

The SAM4L8 Xplained Pro kit contains two crystals that can be used as clock sources for the SAM4L8 device. Each crystal has a cut-strap next to it that can be used to measure the oscillator safety factor. This is done by cutting the strap and adding a resistor across the strap. More information about oscillator allowance and safety factor can be found in application note [AVR4100](#).

**Table 4-7. External 32.768kHz Crystal**

Pin on SAM4L8	Function
XIN32	XIN32
XOUT32	XOUT32

**Table 4-8. External 12MHz Crystal**

Pin on SAM4L8	Function
PA00	XIN0
PA01	XOUT0

### 4.2.3. Mechanical Buttons

The SAM4L8 Xplained Pro contains two mechanical buttons. One button is the RESET button connected to the SAM4L8 reset line and the other is a generic user configurable button. When a button is pressed it will drive the I/O line to GND.

**Table 4-9. Mechanical Buttons**

Pin on SAM4L8	Silkscreen text
RESET_N	RESET
PC24	SW0

**4.2.4. LED**

There is one yellow LED available on the SAM4L8 Xplained Pro board that can be turned on and off. The LED can be activated by driving the connected I/O line to GND.

**Table 4-10. LED Connections**

Pin on SAM4L8	LED
PC07	Yellow LED0

**4.3. Embedded Debugger Implementation**

The SAM4L8 Xplained Pro contains an Embedded Debugger (EDBG) that can be used to program and debug the ATSAM4LC8CA using Serial Wire Debug (SWD). The Embedded debugger also include a Virtual Com port interface over UART, an Atmel Data Gateway Interface over synchronous UART and TWI and it monitors four of the SAM4L8 GPIOs. Atmel Studio can be used as a front end for the Embedded Debugger.

**4.3.1. Serial Wire Debug**

The Serial Wire Debug (SWD) use two pins to communicate with the target. For further information on how to use the programming and debugging capabilities of the EDBG, see the EDBG user guide.

**Table 4-11. SWD Connections**

Pin on SAM4L8	Function
TCK	SWD clock
PA03	SWD data
PA23	SWD trace data

**4.3.2. Virtual COM Port**

The Embedded Debugger act as a Virtual Com Port gateway by using one of the ATSAM4LC8CA UARTs. For further information on how to use the Virtual COM port see the EDBG user guide.

**Table 4-12. Virtual COM Port Connections**

Pin on SAM4L8	Function
PC27	UART TXD (SAM4L8 TX line)
PC26	UART RXD (SAM4L8 RX line)

**4.3.3. Atmel Data Gateway Interface**

The Embedded Debugger features an Atmel Data Gateway Interface (DGI) by using either a synchronous USART or TWI port. The DGI can be used to send a variety of data from the SAM4L8 to the host PC. For further information on how to use the DGI interface see the EDBG user guide.

**Table 4-13. DGI Interface Connections When Using USART**

Pin on SAM4L8	Function
PC29	USART TXD (SAM4L8 TX line)
PC28	USART RXD (SAM4L8 RX line)
PC31	USART CLK

**Table 4-14. DGI Interface Connections When Using TWI**

Pin on SAM4L8	Function
PA23	SDA (Data line)
PA24	SCL (Clock line)

Four GPIO lines are connected to the Embedded Debugger. The EDBG can monitor these lines and time stamp pin value changes. This makes it possible to accurately time stamp events in the SAM4L8 application code. For further information on how to configure and use the GPIO monitoring features see the EDBG user guide.

**Table 4-15. GPIO Lines Connected to the EDBG**

Pin on SAM4L8	Function
PB05	GPIO
PB06	GPIO
PB07	GPIO
PB10	GPIO

## 4.4. Jumper Description

The SAM4L8 Xplained Pro contains five jumpers that can be used to adjust the functionality of the board. You can locate the jumpers in kit overview picture at the start of the user guide. Here is a description of the jumpers.

### Related Links

[Kit Overview](#) on page 4

### 4.4.1. LDO/BUCK Jumper

This jumper selects the power mode of the internal voltage regulator in the target MCU. It can be either LDO mode, which is a linear regulator or BUCK mode, which is a switch mode regulator. If LDO mode is selected, the LDO jumper should be mounted as well.

### 4.4.2. LDO Jumper

This jumper should be mounted when the power mode jumper is set to LDO mode. It will bypass the BUCK mode inductor and increase efficiency for this mode. If the power mode jumper is set to BUCK mode, this jumper needs to be removed to make it work.

### 4.4.3. VLCD\_A and VLCD\_BC Jumpers

When the Segment LCD is not used, these jumpers need to be mounted to power the pins used for segment LCD in GPIO mode.

#### 4.4.4. VCC\_MCU Jumper

This jumper connects VCC to the target MCU. This jumper can be replaced with an ampere meter to measure the current used by the target device. Remember to mount this jumper or an ampere meter to make the target MCU work properly.

## 5. Hardware Revision History and Known Issues

### 5.1. Identifying Product ID and Revision

The revision and product identifier of Xplained Pro boards can be found in two ways; either through Atmel Studio or by looking at the sticker on the bottom side of the PCB.

By connecting an Xplained Pro MCU board to a computer with Atmel Studio running, an information window will pop up. The first six digits of the serial number, which is listed under kit details, contain the product identifier and revision. Information about connected Xplained Pro extension boards will also appear in the Atmel Kit's window.

The same information can be found on the sticker on the bottom side of the PCB. Most kits will print the identifier and revision in plain text as A09-nnnn\rr, where nnnn is the identifier and rr is the revision. Boards with limited space have a sticker with only a QR-code, which contains a serial number string.

The serial number string has the following format:

```
"nnnnrrssssssss"  
n = product identifier  
r = revision  
s = serial number
```

The product identifier for SAM4L8 Xplained Pro is A09-1988.

### 5.2. Revision 1

Revision 1 of SAM4L8 Xplained Pro is the initial released version, there are no known issues.

## 6. Appendix

### 6.1. Getting Started with IAR

IAR Embedded Workbench® for ARM® is a proprietary high efficiency compiler not based on GCC. Programming and debugging of Xplained Pro kits are supported in IAR™ Embedded Workbench for ARM using the common CMSIS-DAP interface. Some initial settings have to be set up in the project to get the programming and debugging to work.

The following steps will explain how to get your project ready for programming and debugging:

1. Make sure you have opened the project you want to configure. Open the **OPTIONS** dialog for the project.
2. In the category **General Options**, select the **Target** tab. [Select the device for the project or, if not listed, the core of the device.](#)
3. In the category **Debugger**, select the **Setup** tab. [Select \*\*CMSIS DAP\*\* as the driver.](#)
4. In the category **Debugger**, select the **Download** tab. [Check the check box for \*\*Use flash loader\(s\)\*\* option.](#)
5. In the category **Debugger > CMSIS DAP**, select the **Setup** tab. [Select \*\*System \(default\)\*\* as the reset method.](#)
6. In the category **Debugger > CMSIS DAP**, select the **JTAG/SWD** tab. [Select \*\*SWD\*\* as the interface and optionally select the \*\*SWD speed\*\*.](#)

Figure 6-1. Select Target Device

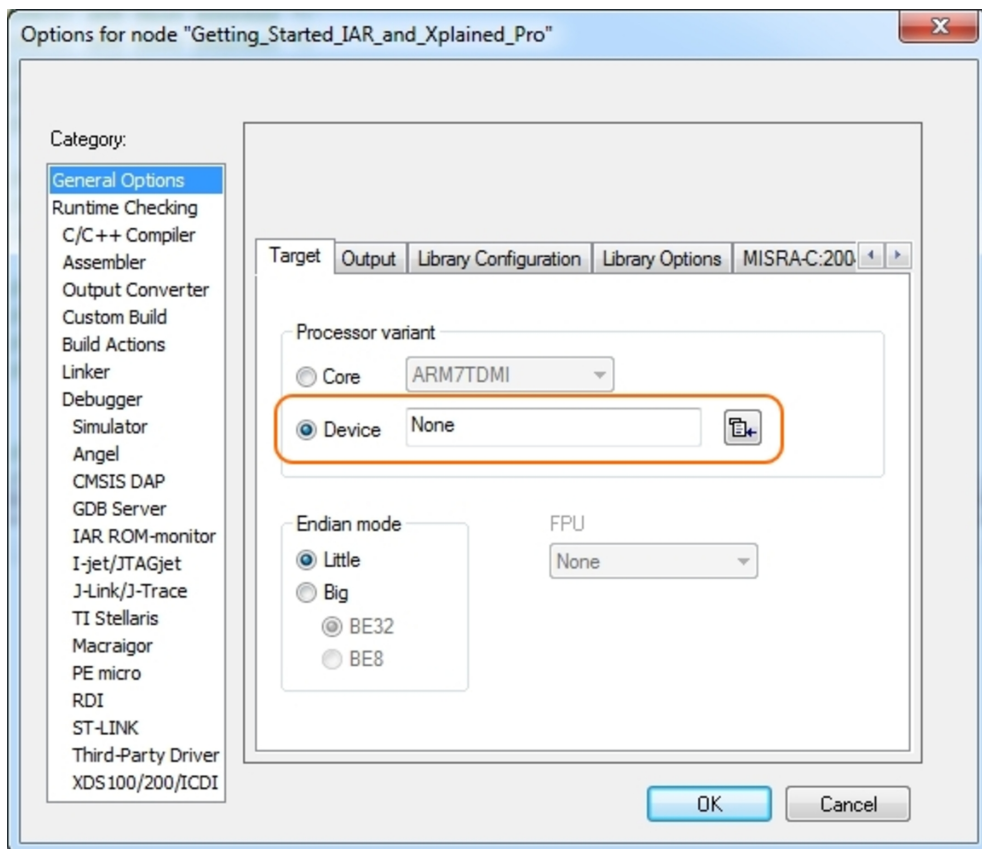



Figure 6-2. Select Debugger

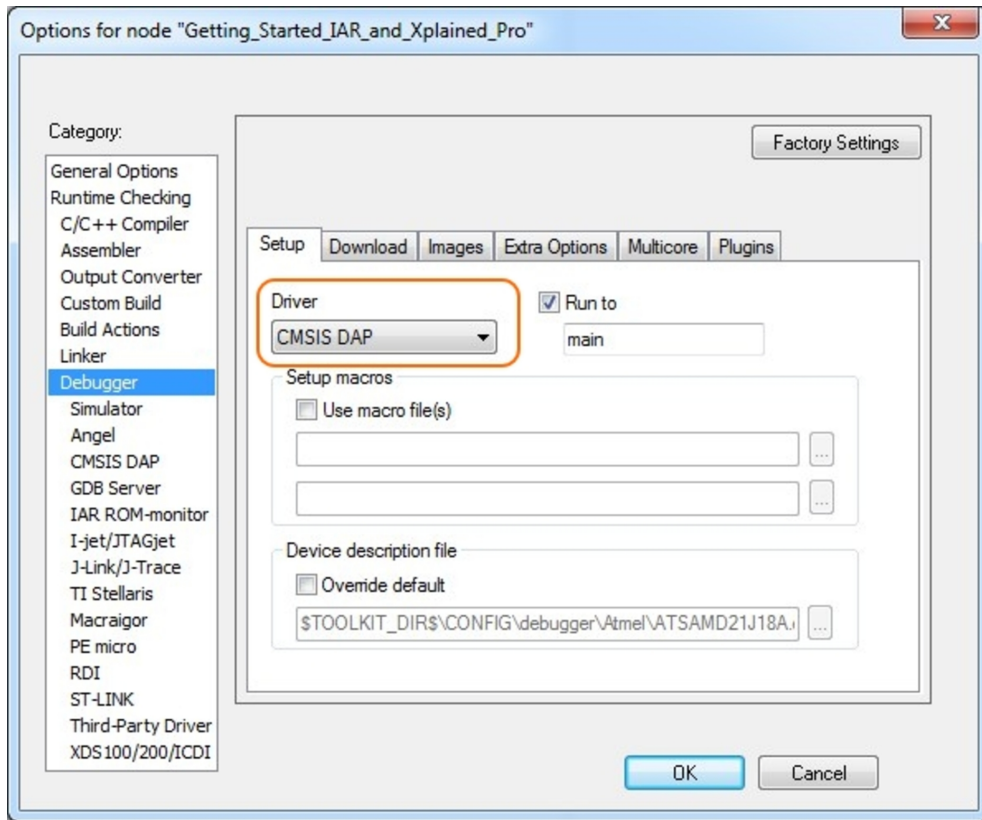

Figure 6-3. Configure Flash Loader

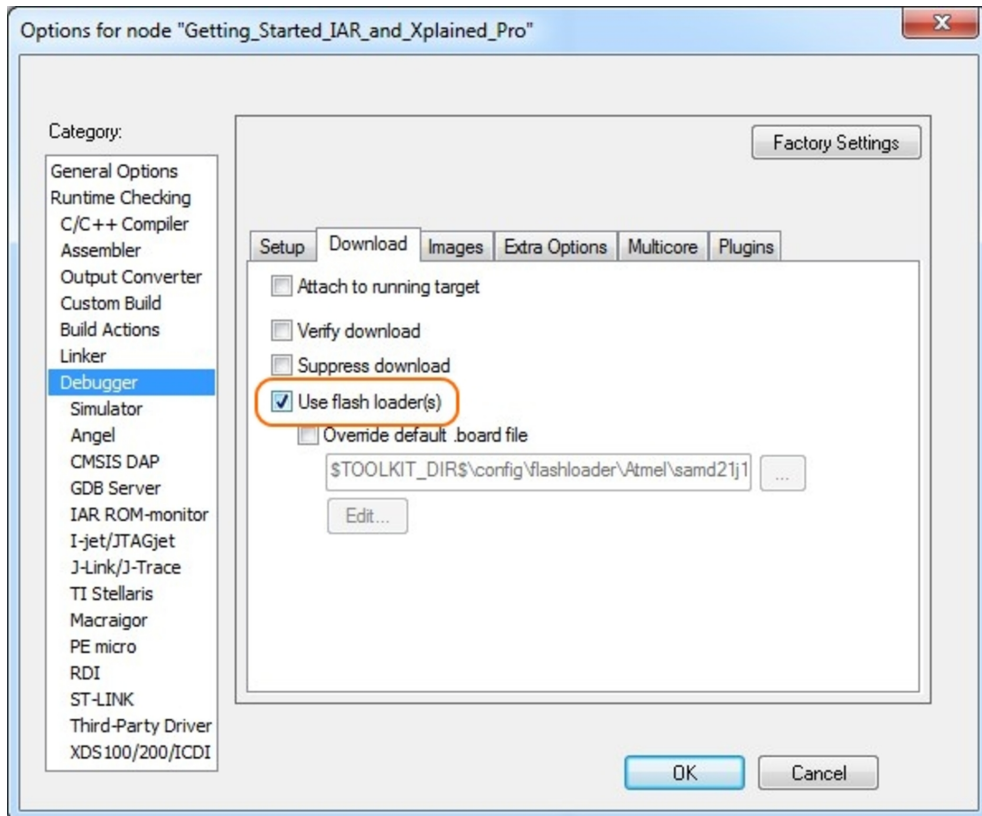

Figure 6-4. Configure Reset

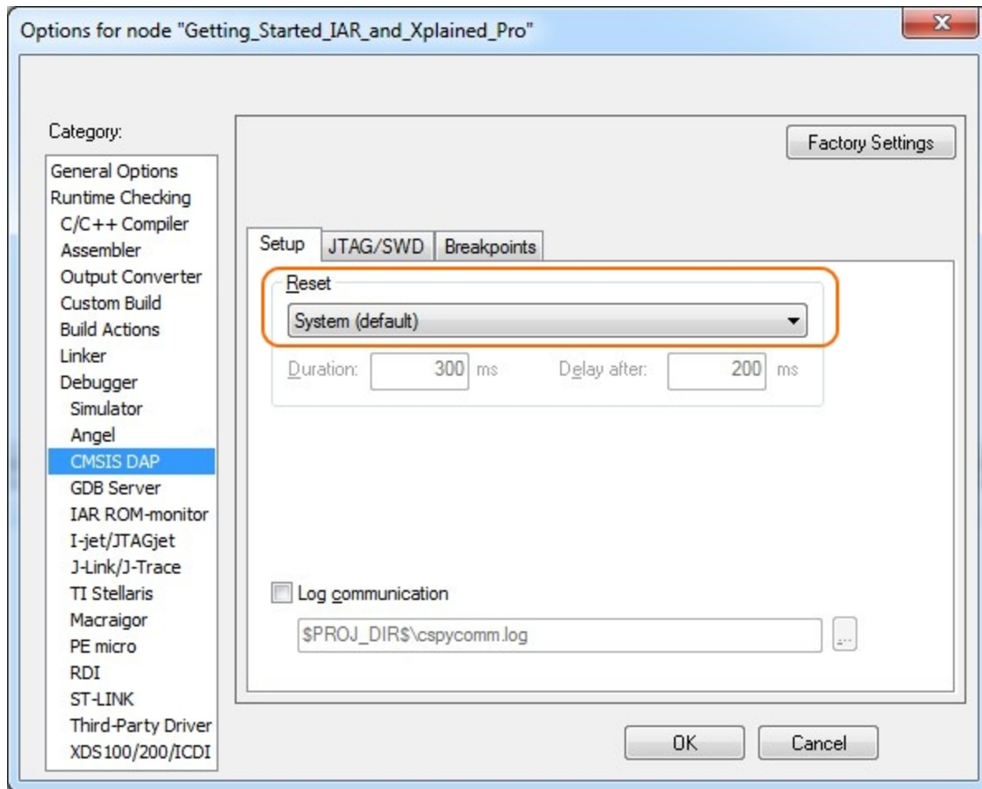
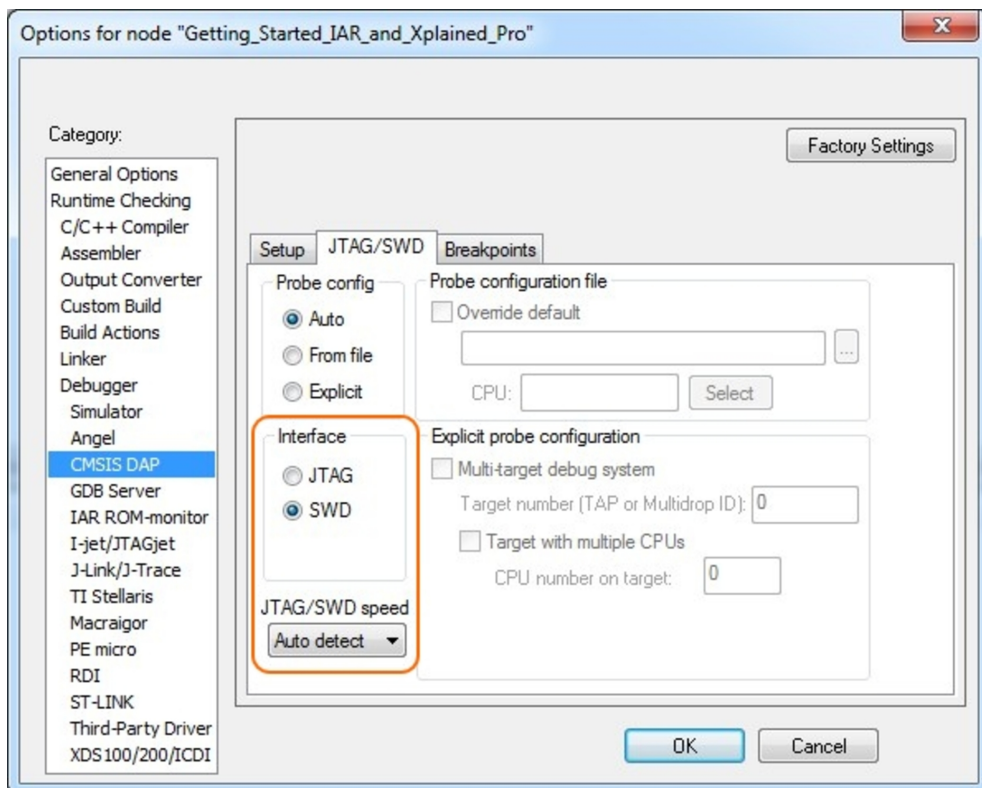

Figure 6-5. Configure Interface



## 7. Document Revision History

Doc. rev.	Date	Comment
42103B	04/2016	Added appendix
42103A	06/2013	First release

## 8. Evaluation Board/Kit Important Notice

This evaluation board/kit is intended for use for **FURTHER ENGINEERING, DEVELOPMENT, DEMONSTRATION, OR EVALUATION PURPOSES ONLY**. It is not a finished product and may not (yet) comply with some or any technical or legal requirements that are applicable to finished products, including, without limitation, directives regarding electromagnetic compatibility, recycling (WEEE), FCC, CE or UL (except as may be otherwise noted on the board/kit). Atmel supplied this board/kit "AS IS", without any warranties, with all faults, at the buyer's and further users' sole risk. The user assumes all responsibility and liability for proper and safe handling of the goods. Further, the user indemnifies Atmel from all claims arising from the handling or use of the goods. Due to the open construction of the product, it is the user's responsibility to take any and all appropriate precautions with regard to electrostatic discharge and any other technical or legal concerns.

EXCEPT TO THE EXTENT OF THE INDEMNITY SET FORTH ABOVE, NEITHER USER NOR ATMEL SHALL BE LIABLE TO EACH OTHER FOR ANY INDIRECT, SPECIAL, INCIDENTAL, OR CONSEQUENTIAL DAMAGES.

No license is granted under any patent right or other intellectual property right of Atmel covering or relating to any machine, process, or combination in which such Atmel products or services might be or are used.

**Mailing Address:**

Atmel Corporation  
1600 Technology Drive  
San Jose, CA 95110  
USA



**Atmel** | Enabling Unlimited Possibilities®



**Atmel Corporation**    1600 Technology Drive, San Jose, CA 95110 USA    **T:** (+1)(408) 441.0311    **F:** (+1)(408) 436.4200    |    **www.atmel.com**

© 2016 Atmel Corporation. / Rev.: Atmel-42103B-SAM4L8-Xplained-Pro\_User Guide-04/2016

Atmel®, Atmel logo and combinations thereof, Enabling Unlimited Possibilities®, AVR®, QTouch®, and others are registered trademarks or trademarks of Atmel Corporation in U.S. and other countries. Windows® is a registered trademarks of Microsoft Corporation in U.S. and or other countries. ARM®, ARM Connected® logo and others are the registered trademarks or trademarks of ARM Ltd. Other terms and product names may be trademarks of others.

**DISCLAIMER:** The information in this document is provided in connection with Atmel products. No license, express or implied, by estoppel or otherwise, to any intellectual property right is granted by this document or in connection with the sale of Atmel products. EXCEPT AS SET FORTH IN THE ATMEL TERMS AND CONDITIONS OF SALES LOCATED ON THE ATMEL WEBSITE, ATMEL ASSUMES NO LIABILITY WHATSOEVER AND DISCLAIMS ANY EXPRESS, IMPLIED OR STATUTORY WARRANTY RELATING TO ITS PRODUCTS INCLUDING, BUT NOT LIMITED TO, THE IMPLIED WARRANTY OF MERCHANTABILITY, FITNESS FOR A PARTICULAR PURPOSE, OR NON-INFRINGEMENT. IN NO EVENT SHALL ATMEL BE LIABLE FOR ANY DIRECT, INDIRECT, CONSEQUENTIAL, PUNITIVE, SPECIAL OR INCIDENTAL DAMAGES (INCLUDING, WITHOUT LIMITATION, DAMAGES FOR LOSS AND PROFITS, BUSINESS INTERRUPTION, OR LOSS OF INFORMATION) ARISING OUT OF THE USE OR INABILITY TO USE THIS DOCUMENT, EVEN IF ATMEL HAS BEEN ADVISED OF THE POSSIBILITY OF SUCH DAMAGES. Atmel makes no representations or warranties with respect to the accuracy or completeness of the contents of this document and reserves the right to make changes to specifications and products descriptions at any time without notice. Atmel does not make any commitment to update the information contained herein. Unless specifically provided otherwise, Atmel products are not suitable for, and shall not be used in, automotive applications. Atmel products are not intended, authorized, or warranted for use as components in applications intended to support or sustain life.

**SAFETY-CRITICAL, MILITARY, AND AUTOMOTIVE APPLICATIONS DISCLAIMER:** Atmel products are not designed for and will not be used in connection with any applications where the failure of such products would reasonably be expected to result in significant personal injury or death ("Safety-Critical Applications") without an Atmel officer's specific written consent. Safety-Critical Applications include, without limitation, life support devices and systems, equipment or systems for the operation of nuclear facilities and weapons systems. Atmel products are not designed nor intended for use in military or aerospace applications or environments unless specifically designated by Atmel as military-grade. Atmel products are not designed nor intended for use in automotive applications unless specifically designated by Atmel as automotive-grade.

# Mouser Electronics

Authorized Distributor

Click to View Pricing, Inventory, Delivery & Lifecycle Information:

[Microchip:](#)

[ATSAM4L8-XPRO](#)