

BF & BD series

Proportional single axis paddle joystick controllers •
non-contacting Hall effect technology



DISTINCTIVE FEATURES

- Sprung or detent options
- Sprung to center or south options
- Two lever heights available
- Inserts available in black, red, blue, yellow & green
- Analog or PWM outputs
- Zero below panel depth



ENVIRONMENTAL SPECIFICATIONS

- Operating Temperature: -25 °C to +70 °C (-13 °F to +158 °F)
- Storage Temperature: -40 °C to +70 °C (-40 °F to +158 °F)
- Above Panel Sealing: IP67
- EMC Immunity Level: EN61000-4-3 (extended) 100 V/m
- EMC Emissions Level: EN61000-6-3:2001, CISPR 22: 2005 Class B 30MHz – 11GHz
- ESD: EN61000-4-2 (extended)



ELECTRICAL SPECIFICATIONS

- Supply Voltage Range: 5 V ± 0.5 V
- Reverse Polarity Max: -10 V
- Overvoltage Max: +20 V
- Recommended min load: 10 Ω
- Return to Center Voltage Tolerance: $V/2 \pm (5\% \times \text{Gain})$



MECHANICAL SPECIFICATIONS

- Maximum Vertical Load: IK08 (BSEN62262:2002)
- Maximum Horizontal Load: 75 N (16.86 lbf)
- Mechanical Angle of Movement: 50°
- Expected Mechanical Life: 5 million (sprung to center versions); 2 million (detent and sprung to south versions) lifecycles
- Mass/weight: 50 g (1.76 oz.)
- Lever Action (centering): Sprung and friction

The company reserves the right to change specifications without notice.



BF & BD series

Proportional single axis paddle joystick controllers •
non-contacting Hall effect technology



MATERIALS

- Housing: Polyetherimide, polycarbonate
- Handles: Polyetherimide, polycarbonate



MOUNTING

PANEL CUT-OUT - DROP-IN MOUNTING

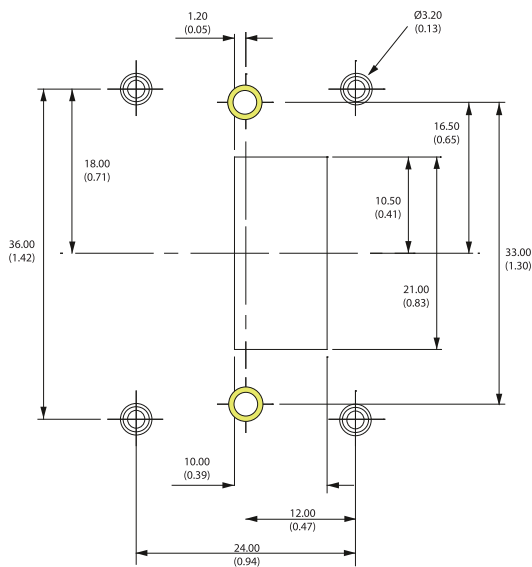

The Paddle may be mounted with two different hole patterns:

- Two screws – in line on the Y axis (shown as yellow screws)
- Four screws – one in each corner (shown as silver screws)

The Paddle is fitted with M3 bushes in all six positions, as standard.

Fasteners are not supplied as standard. The appropriate length of fastener is dependent on panel thickness.

When mounting the Paddle, care should be taken to site it in a position that does not make it vulnerable to damage when in use. If the Paddle is intended for use in a handheld enclosure then care must be taken to protect the Paddle from damage caused by dropping. Basic precautions such as mounting it at the lightest end of the enclosure so it doesn't hit the ground first or by protecting it with a guard should always be implemented for long term reliability.

The body of the Paddle, on the underside of the panel, must not be subject to water spray, excessive humidity or dust.



CONNECTIONS

Paddles are supplied with an eight way connector as standard.

PIN	FUNCTION
1	5V
2	Blank
3	0V
4	Analog/PWM output 1
5	Analog/PWM output 2
6	0V
7	Blank
8	5V



PIN 1



LEVER OPERATION

DETENT OPTIONS

D01 = CENTER DETENT

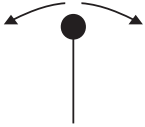

D02 = +/-12.5 DEGREES

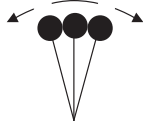

D03 = +/- 12.5 & 25 DEGREES

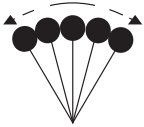

D04 = +/-25 DEGREES

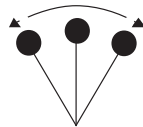

SPRUNG TO CENTER WITH DETENT OPTIONS

SD1 = CENTER DETENT

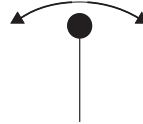

SD2 = +/-12.5 DEGREES

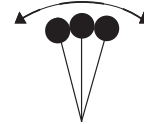

SD3 = +/- 12.5 & 25 DEGREES

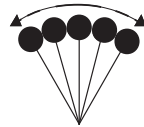

SD4 = +/- 25 DEGREES

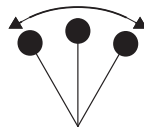

A01 (Sprung to centre)

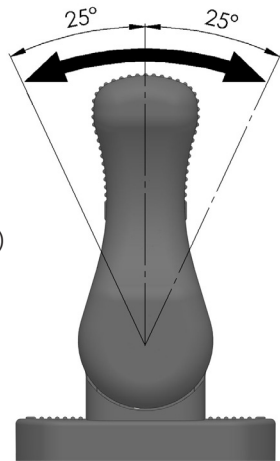

A02 (Sprung to south)

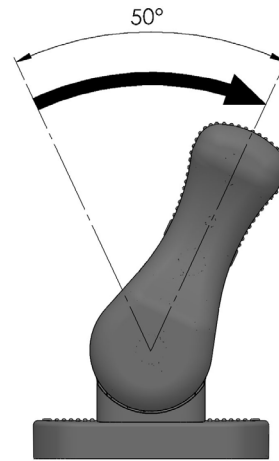

BF & BD series

Proportional single axis paddle joystick controllers •
non-contacting Hall effect technology



BUILD YOUR PART NUMBER

PADDLE

BF	74 mm (2.91 in) above the panel
BD	50 mm (1.97 in) above the panel

CONFIGURATION

1	Standard Dual Outputs
2	Inverse Dual Outputs
3	PWM

GAIN

10	±10%xV
25	±25%xV
30	±30%xV
40	±40%xV
50	±50%xV

LEVER OPERATION

A01	Sprung to Center
A02	Sprung to South
D01	Center Detent
D02	12.5 Degree Detents
D03	12.5 & 25 Degree Detents
D04	25 Degree Detents
SD1	Sprung to Center with D1
SD2	Sprung to Center with D2
SD3	Sprung to Center with D3
SD4	Sprung to Center with D4

INSERT COLOR

BK	Black
RE	Red
BL	Blue
YE	Yellow
GR	Green

MODIFIER

00	No Switches
00	None

BF & BD series

Proportional single axis paddle joystick controllers • non-contacting Hall effect technology

BF PADDLE

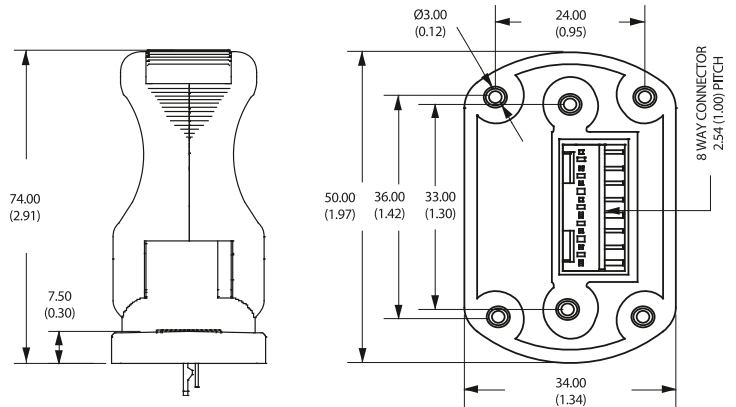

BD PADDLE

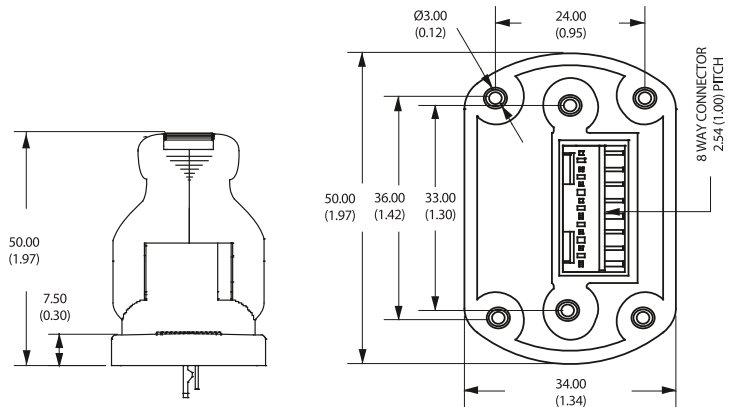

VOLTAGE OUTPUT OPTIONS

DUAL OUTPUT - CONFIGURATION 1

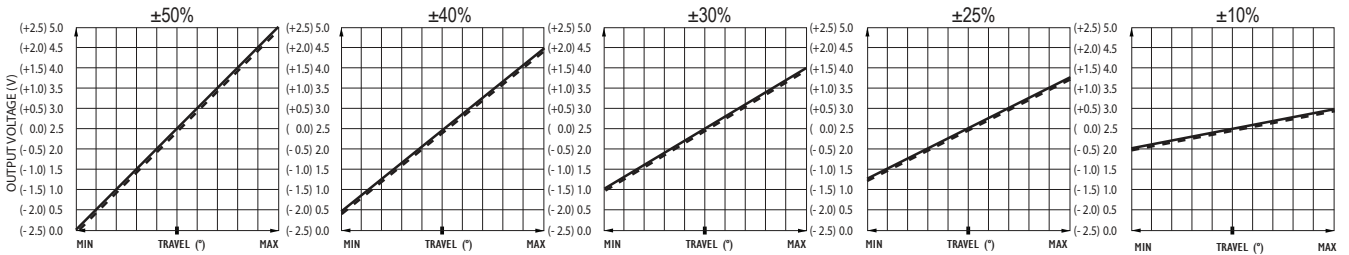

DUAL OUTPUT - CONFIGURATION 2

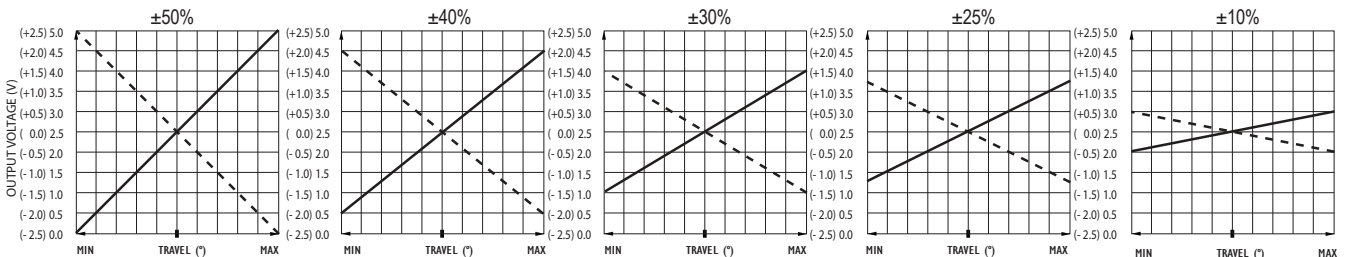

— Output 1
 - - - Output 2

BF & BD series

Proportional single axis paddle joystick controllers •
non-contacting Hall effect technology



CONFIGURATION OPTIONS

OUTPUT OPTIONS

The BF & BD series Paddle is configured as two “electrical” controls in one mechanical package. The Paddle operates from 5V and provides two proportional outputs. The second output is accurate to the first within $\pm 3\%$ of the power supply. The power supply for the secondary output is also completely independent. Customers may choose their preference of voltage outputs (gains).

The secondary output can be of the same or inverse polarity to the primary wiper. For example, with a secondary inverse output, the first and second outputs can be summed and compared to zero to verify that the joystick is operating correctly. Paddles having two identical outputs of the same polarity may be used to drive two identical dual redundant circuits.

There are also two Hall effect switches that trigger at pre-determined lever positions.

The BF series Paddle may be specified with a variety of PWM output options. For more details on available PWM options please refer to APEM.

POWER SUPPLY

The BF & BD Series is designed to be powered by a regulated $5V \pm 0.5V$ power supply. The outputs are ratiometric, making a stable, noise free, power supply essential. The power supply to the joystick should be carefully regulated to be within tolerance.

Should the power supply change outside of the specified tolerances, permanent damage may occur.

MAGNETIC IMMUNITY AND SYSTEM DESIGN

The BF & BD Series incorporates internal magnetic screening to minimize the effect of external magnetic fields. Mounting or operating the Paddle close to strong magnetic fields is not recommended. System designers should follow best practice when incorporating the BF Series Paddle into their products.

Care should be taken to decouple the power supply properly and to employ adequate EMC shielding.

HANDLE OPTIONS

The BF & BD series offers two standard handle options. The taller (74mm) handle provides the most ergonomic solution while the shorter (50mm) is best suited to hand held applications where a minimized height is preferred. The taller lever is supplied with the top insert prefitted, however the shorter lever may be specified with no insert fitted and the snap in inserts supplied loose for ease of customer integration.

Note: All snap in inserts may only be fitted once, and are not removable once fitted.

SELECTABLE SWITCHING POINTS

The Paddle incorporates two Hall effect switches. The angle of the lever at the switch trigger point can be selected when ordering.

If no switches are specified then the output on pins 2 and 7 will be unused.

The outputs are configured as ‘open drain’ type with a 1K5 pull up resistor to 5V.

GAIN OPTIONS

The voltage output on the wiper, at full scale deflection is determined by the gain. The gain is expressed as a percentage of the voltage supplied.

Therefore (assuming a 5V supply) a Paddle specified with $\pm 25\%$ gain would yield 1.25V at South, 2.5V at center and 3.75V at North. A range of gain options are available as standard.

All controls are supplied pre-set and no further calibration is needed throughout the lifetime of operation.

OUTPUT IMPEDANCE

The voltage outputs at center and at each end of travel are specified across an infinite load, with no current flowing. The output impedance specified in the electrical specification should be taken into account when designing a system.

Load resistance of less than 10K Ohms is not recommended.

Mouser Electronics

Authorized Distributor

Click to View Pricing, Inventory, Delivery & Lifecycle Information:

[Apem:](#)

[BF240A01BK1200](#)