

1 MBB1 Stößel

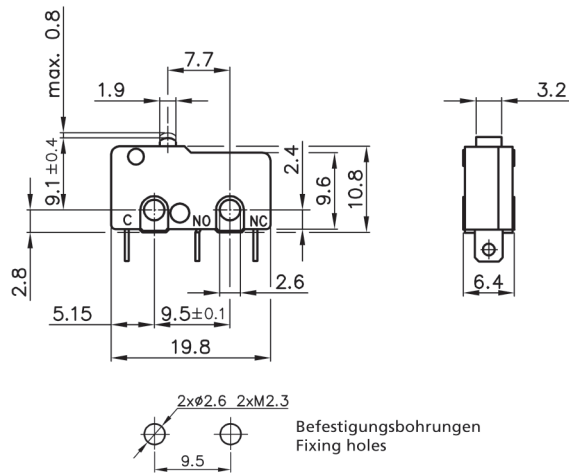
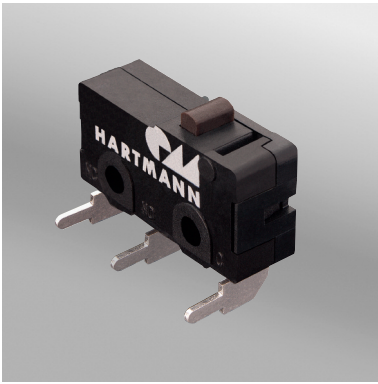

Blattfeder Kontaktsystem

- Microschalter Bauform B gem. DIN 41635
- funktionale Endkontrolle
- solide Konstruktion
- hochwertige Materialien
- sehr genaue Schaltlage
- Version 100mA 12VDC mit Goldkontakten auf Anfrage

Microschalter, auch als Schnappschalter bezeichnet, werden vorrangig als Endschalter eingesetzt, sind aber auch für viele weitere Industrieanwendungen geeignet. Die Schaltgeschwindigkeit ist weitgehend unabhängig von der eigentlichen Betätigungsgeschwindigkeit. Die nach ISO 9001:2000 zertifizierte Fertigung und die 100% funktionale Endkontrolle garantieren die zuverlässige Funktion. Bei diesen Schaltern haben wir unsere langjährige Erfahrung und Zuverlässigkeit im Schalterbau eingebracht.

Leaf spring mechanism

- Micro switches design B acc. to DIN 41635
- functional final inspection and testing
- solid design
- high-quality materials
- very exact switching position
- Version 100mA 12VDC with Au plated contacts on request

Micro switches, also known as snap action switches, are primarily used as limit switches, but are also suitable for many other industry applications. The actual switching speed is completely independent from the speed of operation. ISO 9001:2000 approved production together with 100% functional final inspection and testing guarantee reliable operation. These products reflect our long standing experience in design and production of high quality switches.

MECHANISCHE KENNWERTE		MECHANICAL DATA	
Mech. Lebensdauer		Mech. lifetime	1 000 000 Schaltungen / 1 000 000 actuations
Elektr. Lebensdauer		Electrical lifetime	min. 10 000 Schaltungen / min. 10 000 actuations
abhängig von Schaltleistung		depending on switching capacity	
Differenzweg		Movement differential	≤ 0,2mm
Vorlaufweg		Pretravel	≤ 0,8mm
Nachlaufweg		Overtravel	min. 0,5mm
Schaltpunkt		Operating position	9,1 ± 0,4mm
Kontaktöffnungsweite		Contact opening	<3mm (μ)
SONSTIGE KENNWERTE		OTHER DATA	
Zulassungen		Approvals	VDE, cULus
MATERIAL		MATERIAL	
Gehäuse		Housing	PBT
Deckel		Cover	PBT
Betätiger		Actuator	PPS
Anschlüsse		Terminals	CuZn versilbert / CuZn Ag plated
Kontakte		Contacts	AgNi
Kontaktgeber		Contact spring	CuBe





MBB1 Plunger

2 SCHALTLEISTUNG / RATING

	cULus		Code:	MBB1	01	3	4	5	6	7
5A 250VAC	5A 125VAC									
10A 250VAC	10A 125VAC		Code:	MBB1	02	3	4	5	6	7
100mA 12VDC			Code:	MBB1	06	3	4	5	6	7

Weitere Schaltleistungen auf Anfrage / Further ratings on request



3 BETÄTIGUNGSKRAFT / OPERATING FORCE

1,0N		Code:	MBB1	2	A	4	5	6	7
1,5N		Code:	MBB1	2	B	4	5	6	7
2,0N		Code:	MBB1	2	C	4	5	6	7
2,5N		Code:	MBB1	2	D	4	5	6	7
3,0N		Code:	MBB1	2	E	4	5	6	7

4 UMGEBUNGSTEMPERATUR / AMBIENT TEMPERATURE

-10...+85°C	Code:	MBB1	2	3	01	5	6	7
-------------	-------	------	---	---	----	---	---	---

5 KONTAKTANORDNUNG / CONTACT ARRANGEMENT

Öffner / Normally closed	Schließer / Normally open	Wechsler / Change-over
 Code: MBB1 2 3 4 A 6 7	 Code: MBB1 2 3 4 B 6 7	Code: MBB1 2 3 4 C 6 7

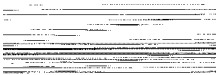

MBB1 Stößel

6 BETÄTIGER / ACTUATOR

Stößel / Plunger

Code: MBB1 2 3 4 5 01 7

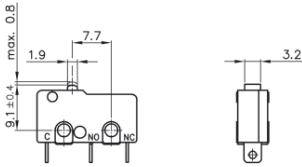

7 ANSCHLÜSSE / TERMINALS

Flachlötanschluss / Solder terminal

Code: MBB1 2 3 4 5 6 A

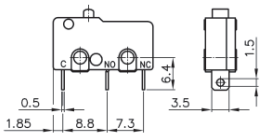

LP-Anschluss links / PCB terminal left

Code: MBB1 2 3 4 5 6 B

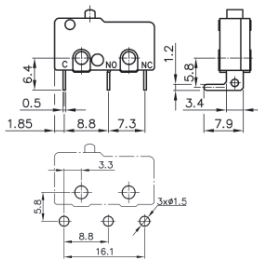

LP-Anschluss rechts / PCB terminal right

Code: MBB1 2 3 4 5 6 C

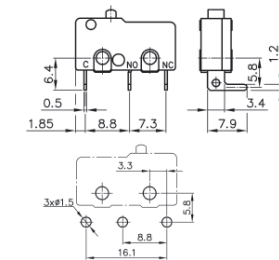

LP-Anschluss / PCB terminal

Code: MBB1 2 3 4 5 6 D

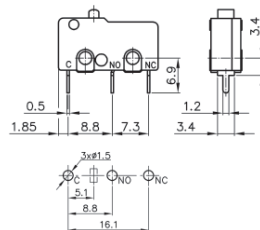

Steckkontakt / Plug connection

Code: MBB1 2 3 4 5 6 E

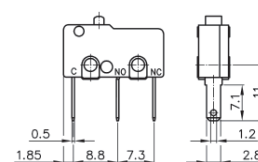

1

MBB1 Hebel

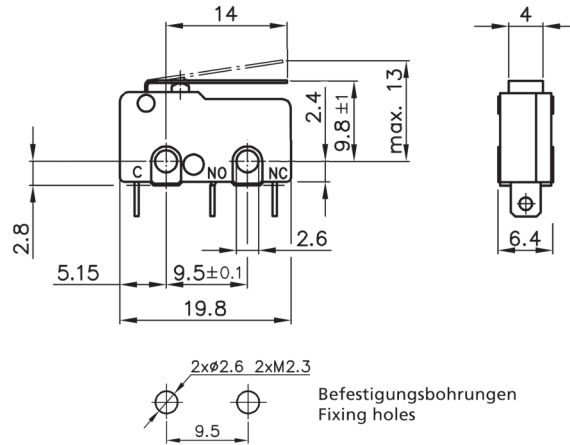
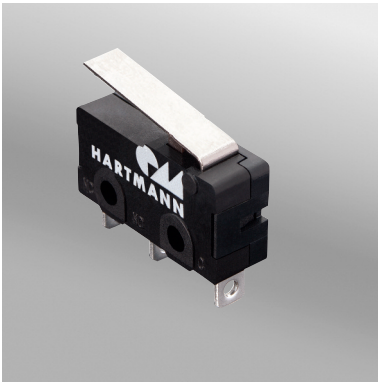

Blattfeder Kontaktsystem

- Microschalter Bauform B gem. DIN 41635
- funktionale Endkontrolle
- solide Konstruktion
- hochwertige Materialien
- sehr genaue Schaltlage
- Version 100mA 12VDC mit Goldkontakten auf Anfrage

Microschalter, auch als Schnappschalter bezeichnet, werden vorrangig als Endschalter eingesetzt, sind aber auch für viele weitere Industrieanwendungen geeignet. Die Schaltgeschwindigkeit ist weitgehend unabhängig von der eigentlichen Betätigungsgeschwindigkeit. Die nach ISO 9001:2000 zertifizierte Fertigung und die 100% funktionale Endkontrolle garantieren die zuverlässige Funktion. Bei diesen Schaltern haben wir unsere langjährige Erfahrung und Zuverlässigkeit im Schalterbau eingebracht.

Leaf spring mechanism

- Micro switches design B acc. to DIN 41635
- functional final inspection and testing
- solid design
- high-quality materials
- very exact switching position
- Version 100mA 12VDC with Gold contacts on request

Micro switches, also known as snap action switches, are primarily used as limit switches, but are also suitable for many other industry applications. The actual switching speed is completely independent from the speed of operation. ISO 9001:2000 approved production together with 100% functional final inspection and testing guarantee reliable operation. These products reflect our long standing experience in design and production of high quality switches.

MECHANISCHE KENNWERTE	MECHANICAL DATA	
Mech. Lebensdauer	Mech. lifetime	1 000 000 Schaltungen / 1 000 000 actuations
Elektr. Lebensdauer	Electrical lifetime	min. 10 000 Schaltungen / min. 10 000 actuations
abhängig von Schaltleistung	depending on switching capacity	
Differenzweg	Movement differential	siehe Übersicht nächste Seite / please see overview next page
Vorlaufweg	Pretravel	siehe Übersicht nächste Seite / please see overview next page
Nachlaufweg	Overtravel	siehe Übersicht nächste Seite / please see overview next page
Schaltpunkt	Operating position	siehe Übersicht nächste Seite / please see overview next page
Kontaktöffnungsweite	Contact opening	<3mm (μ)
SONSTIGE KENNWERTE	OTHER DATA	
Zulassungen	Approvals	VDE, cULus
MATERIAL	MATERIAL	
Gehäuse	Housing	PBT
Deckel	Cover	PBT
Betätiger	Actuator	PPS
Anschlüsse	Terminals	CuZn versilbert / CuZn Ag plated
Kontakte	Contacts	AgNi
Kontaktgeber	Contact spring	CuBe

MBB1 Hinge lever





2 SCHALTLEISTUNG / RATING

cULus

5A 250VAC	5A 125VAC		Code: MBB1 01	3	4	5	6	7
10A 250VAC			Code: MBB1 02	3	4	5	6	7
100mA 12VDC			Code: MBB1 06	3	4	5	6	7

Weitere Schaltleistungen auf Anfrage / Further ratings on request



3 BETÄTIGUNGSKRAFT / OPERATING FORCE

1,0N			Code: MBB1 2 A	4	5	6	7
1,5N			Code: MBB1 2 B	4	5	6	7
2,0N			Code: MBB1 2 C	4	5	6	7
2,5N			Code: MBB1 2 D	4	5	6	7
3,0N			Code: MBB1 2 E	4	5	6	7

4 UMGEBUNGSTEMPERATUR / AMBIENT TEMPERATURE

-10...+85°C	Code: MBB1 2 3 01	5	6	7
-------------	--------------------------	---	---	---

5 KONTAKTANORDNUNG / CONTACT ARRANGEMENT

Öffner / Normally closed  Code: MBB1 2 3 4 A 6 7	Schließer / Normally open  Code: MBB1 2 3 4 B 6 7	Wechsler / Change-over Code: MBB1 2 3 4 C 6 7
---	--	---



MBB1 Hebel

6 BETÄTIGER / ACTUATOR

Hebel 14mm / Hinge lever 14mm

Code: MBB1 2 3 4 5 08 7

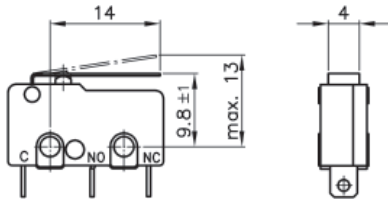

7 ANSCHLÜSSE / TERMINALS

Flachlötanschluss / Solder terminal

Code: MBB1 2 3 4 5 6 A

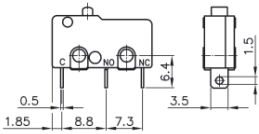

LP-Anschluss links / PCB terminal left

Code: MBB1 2 3 4 5 6 B

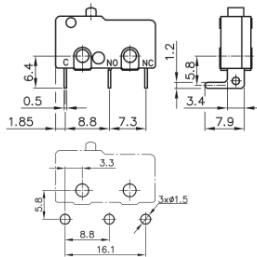

LP-Anschluss rechts / PCB terminal right

Code: MBB1 2 3 4 5 6 C

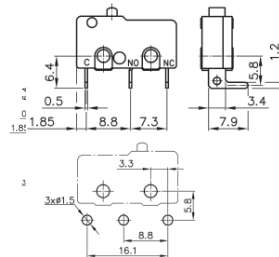

LP-Anschluss / PCB terminal

Code: MBB1 2 3 4 5 6 D

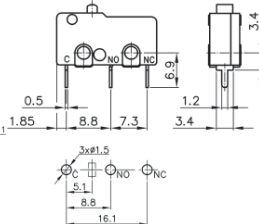

Steckkontakt / Plug connection

Code: MBB1 2 3 4 5 6 E

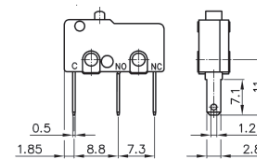

MBB1 Hinge lever

ÜBERSICHT BETÄTIGER / WEGE / KRÄFTE
OVERVIEW ACTUATORS / TRAVEL / FORCES

	Code	Zusatzbetätigerlänge Actuator length	Betätigungskraft am Stößel Operating force on plunger	Betätigungskraft am Zusatzbetätiger Operating force on lever	Vorlaufweg Pretravel	Nachlaufweg Overtravel	Differenzweg Movement differential	Ruhestellung Free position	Schaltpunkt Operating position	
		mm	≤ N	Code	≤ N	≤ mm	min. mm	≤ mm	≤ mm	mm
Hebel 14mm	08	14	1,0	A	0,30	4,2	1,0	0,8	13,0	9,8 ±1
Hinge lever 14mm			1,5	B	0,45					
			2,0	C	0,60					
			2,5	D	0,75					
			3,0	E	0,90					

1

MBB1 Rolle

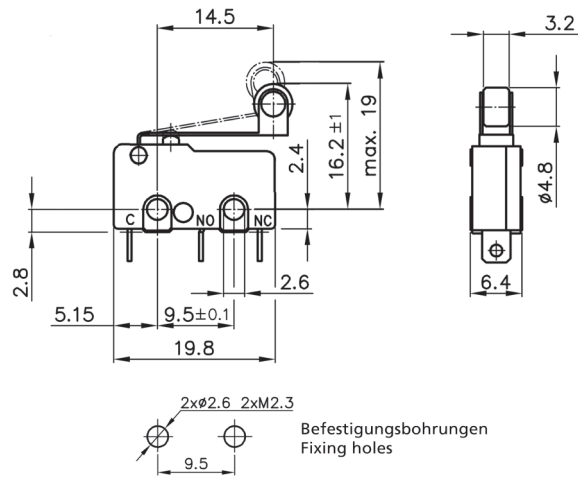

Blattfeder Kontaktsystem

- Microschalter Bauform B gem. DIN 41635
- funktionale Endkontrolle
- solide Konstruktion
- hochwertige Materialien
- sehr genaue Schaltlage
- Version 100mA 12VDC mit Goldkontakten auf Anfrage

Microschalter, auch als Schnappschalter bezeichnet, werden vorrangig als Endschalter eingesetzt, sind aber auch für viele weitere Industrieanwendungen geeignet. Die Schaltgeschwindigkeit ist weitgehend unabhängig von der eigentlichen Betätigungsgeschwindigkeit. Die nach ISO 9001:2000 zertifizierte Fertigung und die 100% funktionale Endkontrolle garantieren die zuverlässige Funktion. Bei diesen Schaltern haben wir unsere langjährige Erfahrung und Zuverlässigkeit im Schalterbau eingebracht.

Leaf spring mechanism

- Micro switches design B acc. to DIN 41635
- functional final inspection and testing
- solid design
- high-quality materials
- very exact switching position
- Version 100mA 12VDC with Gold contacts on request

Micro switches, also known as snap action switches, are primarily used as limit switches, but are also suitable for many other industry applications. The actual switching speed is completely independent from the speed of operation. ISO 9001:2000 approved production together with 100% functional final inspection and testing guarantee reliable operation. These products reflect our long standing experience in design and production of high quality switches.

MECHANISCHE KENNWERTE	MECHANICAL DATA	
Mech. Lebensdauer	Mech. lifetime	1 000 000 Schaltungen / 1 000 000 actuations
Elektr. Lebensdauer	Electrical lifetime	min. 10 000 Schaltungen / min. 10 000 actuations
abhängig von Schaltleistung	depending on switching capacity	
Differenzweg	Movement differential	siehe Übersicht nächste Seite / please see overview next page
Vorlaufweg	Pretravel	siehe Übersicht nächste Seite / please see overview next page
Nachlaufweg	Overtravel	siehe Übersicht nächste Seite / please see overview next page
Schaltpunkt	Operating position	siehe Übersicht nächste Seite / please see overview next page
Kontaktöffnungsweite	Contact opening	<3mm (µ)
SONSTIGE KENNWERTE	OTHER DATA	
Zulassungen	Approvals	VDE, cULus
MATERIAL	MATERIAL	
Gehäuse	Housing	PBT
Deckel	Cover	PBT
Betätiger	Actuator	PPS
Anschlüsse	Terminals	CuZn versilbert / CuZn Ag plated
Kontakte	Contacts	AgNi
Kontaktgeber	Contact spring	CuBe

MBB1 Roller lever

2 SCHALTLEISTUNG / RATING

cULus

5A 250VAC	5A 125VAC		Code: MBB1 01	3	4	5	6	7
10A 250VAC			Code: MBB1 02	3	4	5	6	7
100mA 12VDC			Code: MBB1 06	3	4	5	6	7

Weitere Schaltleistungen auf Anfrage / Further ratings on request



3 BETÄTIGUNGSKRAFT / OPERATING FORCE

1,0N			Code: MBB1 2 A	4	5	6	7
1,5N			Code: MBB1 2 B	4	5	6	7
2,0N			Code: MBB1 2 C	4	5	6	7
2,5N			Code: MBB1 2 D	4	5	6	7
3,0N			Code: MBB1 2 E	4	5	6	7

4 UMGEBUNGSTEMPERATUR / AMBIENT TEMPERATURE

-10...+85°C	Code: MBB1 2 3 01	5	6	7
-------------	--------------------------	---	---	---

5 KONTAKTANORDNUNG / CONTACT ARRANGEMENT

Öffner / Normally closed  Code: MBB1 2 3 4 A 6 7	Schließer / Normally open  Code: MBB1 2 3 4 B 6 7	Wechsler / Change-over Code: MBB1 2 3 4 C 6 7
---	--	---



MBB1 Rolle

6 BETÄTIGER / ACTUATOR

Rolle 14,5mm / Roller lever 14.5mm

Code: MBB1 2 3 4 5 09 7

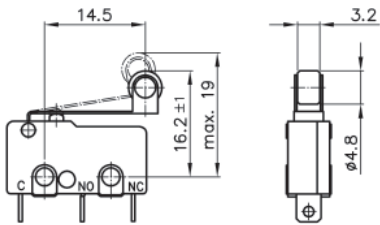

Simulierte Rolle 14,5mm R3 / Sim. roller I. R3

Code: MBB1 2 3 4 5 10 7

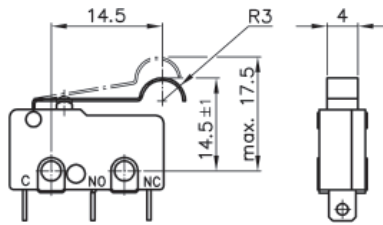

Simulierte Rolle 15,2mm R1,2 / Sim. roller I. R1.2

Code: MBB1 2 3 4 5 11 7

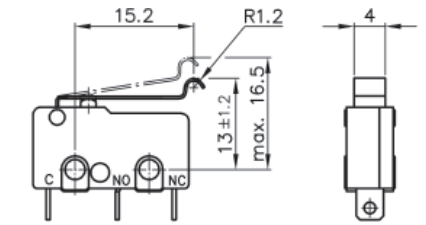

7 ANSCHLÜSSE / TERMINALS

Flachlötanschluss / Solder terminal

Code: MBB1 2 3 4 5 6 A

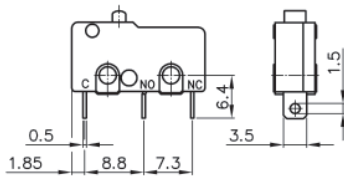

LP-Anschluss links / PCB terminal left

Code: MBB1 2 3 4 5 6 B

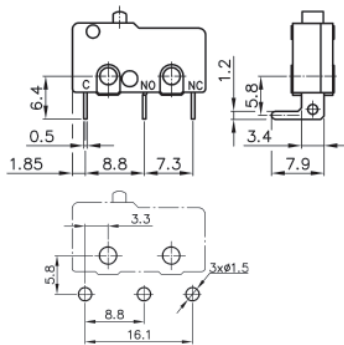

LP-Anschluss rechts / PCB terminal right

Code: MBB1 2 3 4 5 6 C

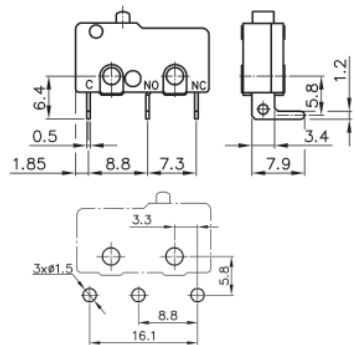

LP-Anschluss / PCB terminal

Code: MBB1 2 3 4 5 6 D

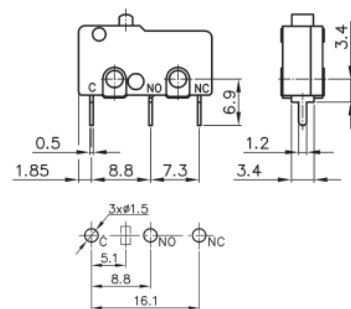

Steckkontakt / Plug connection

Code: MBB1 2 3 4 5 6 E

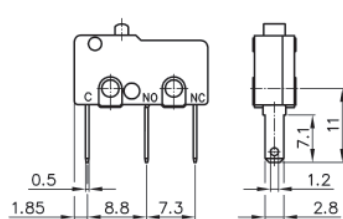

MBB1 Roller lever

ÜBERSICHT BETÄTIGER / WEGE / KRÄFTE
OVERVIEW ACTUATORS / TRAVEL / FORCES

	Code	mm	≤ N	Code	≤ N	≤ mm	min. mm	≤ mm	≤ mm	mm
Rolle 14,5mm	09	14,5	1,0	A	0,30	3,8	1,2	0,8	19,0	16,2 ±1
Roller lever 14,5mm			1,5	B	0,45					
			2,0	C	0,60					
			2,5	D	0,75					
			3,0	E	0,90					
	Code	mm	≤ N	Code	≤ N	≤ mm	min. mm	≤ mm	≤ mm	mm
Simulierte Rolle 14,5mm	10	14,5	1,0	A	0,30	4,0	1,2	0,8	17,5	14,5 ±1
Simulated roller lever 14,5mm			1,5	B	0,45					
			2,0	C	0,60					
			2,5	D	0,75					
			3,0	E	0,90					
	Code	mm	≤ N	Code	≤ N	≤ mm	min. mm	≤ mm	≤ mm	mm
Simulierte Rolle 15,2mm	11	15,2	1,0	A	0,25	4,7	1,2	0,8	16,5	13 ±1,2
Simulated roller lever 15,2mm			1,5	B	0,38					
			2,0	C	0,50					
			2,5	D	0,63					
			3,0	E	0,75					

Mouser Electronics

Authorized Distributor

Click to View Pricing, Inventory, Delivery & Lifecycle Information:

[Apem:](#)

[MBB101A01C01B](#) [MBB101A01C08A](#)