

WASHABLE TACT SWITCH



FEATURES

- Sharp click feel with a positive tactile feedback.
- Ultraminiature structure suitable for high density mounting. Economic but high reliability.
- Insert molded contacts with special treatment prevents flux build-up during soldering and permits auto-dipping.
- Allows submersed washing after soldering.

MATERIALS

COVER: Stainless Steel.
 TERMINALS: Brass with silver plating.
 BASE: UL94V-0 Nylon, High Temperature Thermoplastic.
 Color:Black

ITEM NO.	ADTSHW66N ADTSMW66N ADTSJW66N	ADTSHW68S ADTSMW68S ADTSJW68S
STEM	High-Temp. Thermoplastic Nylon UL 94V-0 Color: Brown(N), 160gf	None
ADHESIVE TAPE	TEFLON	TEFLON (Standard) KAPTON (V-option)
METAL STEM	Brass with Nickel plating	Brass with Nickel plating
FILLER	None	None
CONTACT	Phosphor bronze with silver cladding (Standard) Stainless steel (V-option)	

ITEM NO.	ADTS(H)MW69,65N (R)T ADTSJW69,65N (R)T	ADTS(H)MW67N(R)T ADTSJW67N(R)T
STEM	Silicone Rubber	Silicone Rubber
ADHESIVE TAPE	None	None
METAL STEM	None	None
FILLER	None	Nylon
CONTACT	Phosphor bronze with silver cladding(Standard) Stainless steel(V-option)	Stainless Steel

GENERAL SPECIFICATIONS

ELECTRICAL

Electrical life: 500,000 cycles for ADTS W 69, 67N(R)T, 65N(R)T, 64N(R)
 100,000 cycles for ADTS W 66N,68S

Rating: 50 mA, 12 VDC.
 Contact resistance: 100 milliohms max.
 Insulation resistance: 100 megohms min. 500 VDC.
 Dielectric Strength: 250 VAC /1 minute.
 Contact Arrangement: 1 pole 1 throw.

MECHANICAL

Stop Strength: 3kgf max, continuous vertical static load.

Stroke: 0.25 + 0.2 mm - 0.1 mm 66N, 68S
 0.6 ± 0.2 mm, 69, 67T
 0.45 ± 0.2 mm, 69, 67, 65N(R), 65T, 64, J=64N(R)

Operation Temperature Range: -25°C to +70°C

Storage Temperature: -30°C to +80°C

Shock Resistance: 50G per method 213B, MIL - STD - 202F

Vibration Resistance: Passes method 201A, MIL - STD - 202F

SPECIFICATIONS SUBJECT TO CHANGE WITHOUT NOTICE.

SOLDERING PROCESSES

HAND SOLDERING: 350°C max. for 5 seconds max. (30 watt iron max).

WAVE SOLDERING: 260°C max. for 5 seconds max.

REFLOW SOLDERING: 255°C max.(see profile)



CIRCUIT

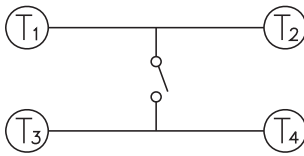

HOW TO ORDER

A D T S



W



V



B = Tube Package
T/R = Tape & Reel
 = Bulk (J Type only)

V = Lead Free Solderable

Color Of Stem For Operating Force:

N = Brown, 160gf (66N)
180gf (69N, 67N, 65N, 64)

S = Silver, 160gf

R = Red, 260gf

T = Transparent, 360gf (69T, 67T, 65T)

Dimension H:

64 = 4.5mm (N, R)

65 = 3.5mm (N, R, T)

66 = 3.1mm (N)

67 = 5.2mm (N, R, T)

68 = 2.3mm (S)

69 = 3.8mm (N, R, T)

H: Through Hole Terminals

J: Surface Mounting Type

M: Surface Mounting Type

SPECIFICATIONS SUBJECT TO CHANGE WITHOUT NOTICE.

SPECIFICATIONS SUBJECT TO CHANGE WITHOUT NOTICE.

ADTSHW66

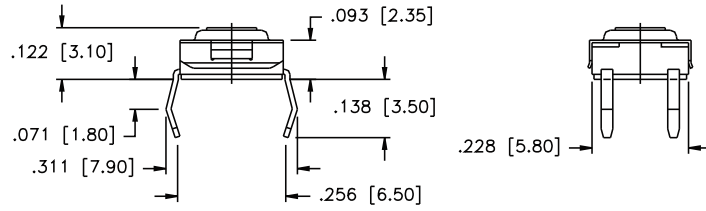
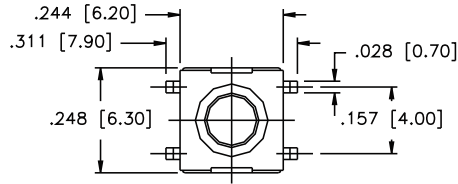

ADTSHW68

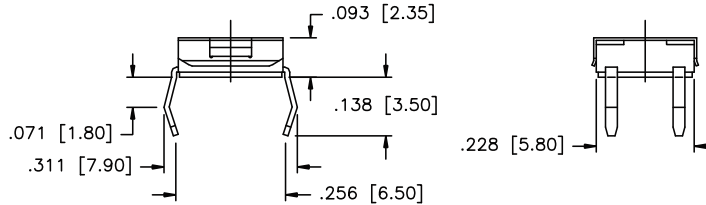
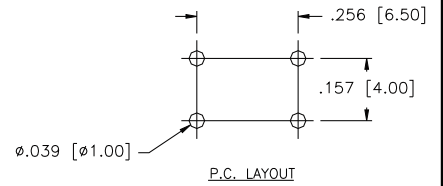
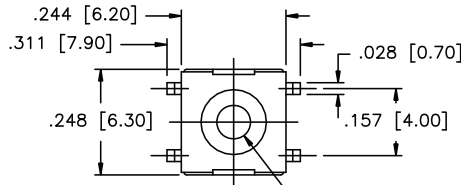

**ADTSHW69
ADTSHW67
ADTSHW65
ADTSHW64**

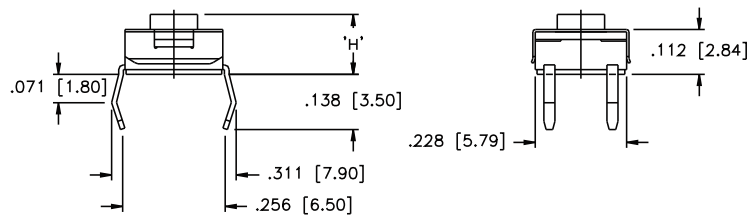
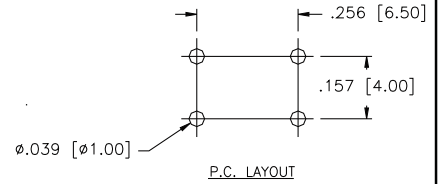
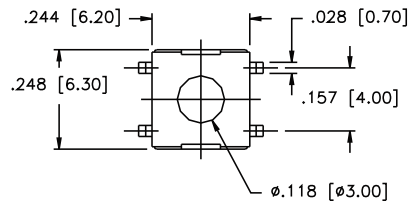

ADTSJW66

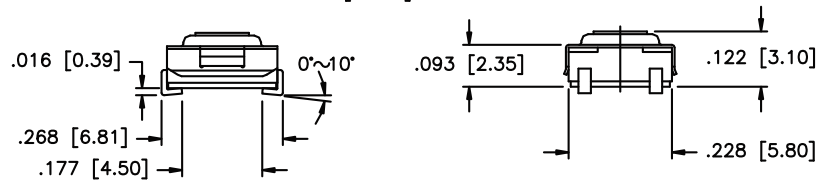
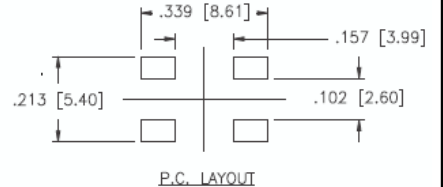
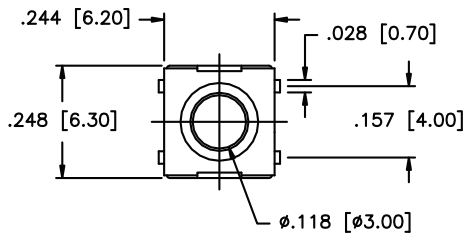

ADTSJW68

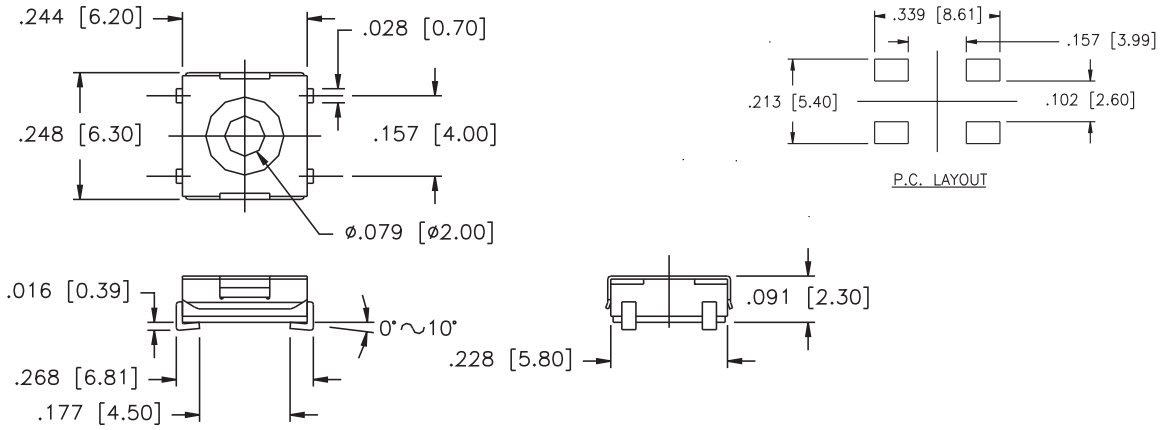

**ADTSJW69
ADTSJW67
ADTSJW65**

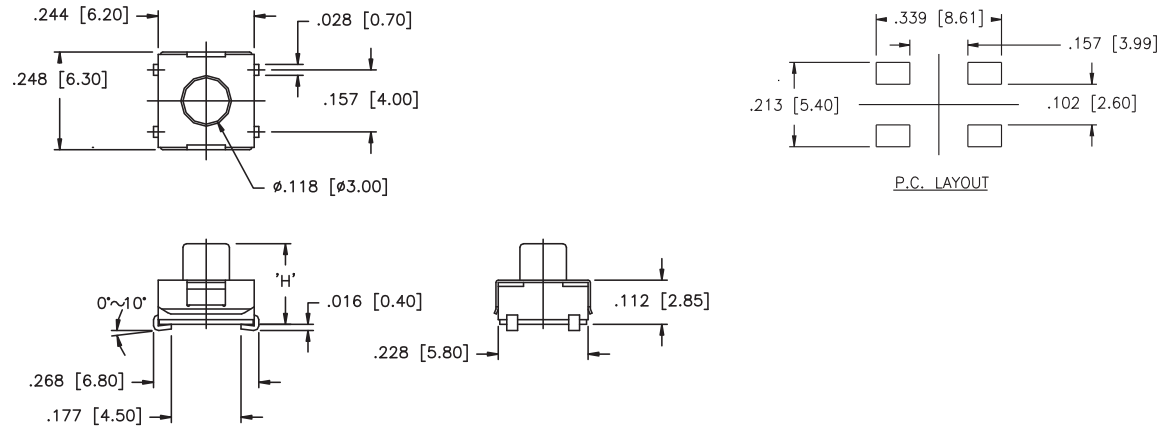

ADTSMW66



ADTSMW68

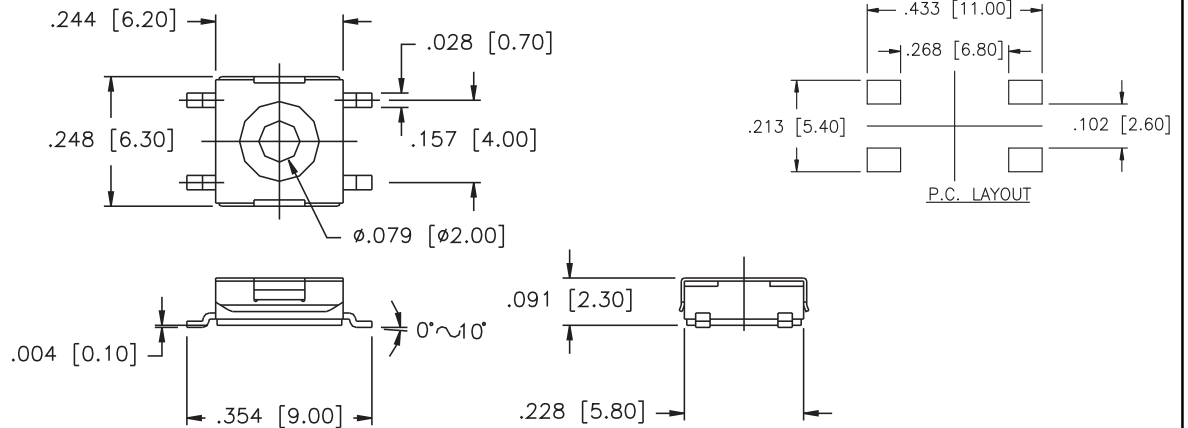

SPECIFICATIONS SUBJECT TO CHANGE WITHOUT NOTICE.

SPECIFICATIONS SUBJECT TO CHANGE WITHOUT NOTICE.

ADTSMW69
ADTSMW67
ADTSMW65
ADTSMW64



PACKAGING

Tube: 75 pcs/tube

- ADTSMW64 -T/R: 900 pcs/reel
- ADTSMW65 -T/R: 1900 pcs/reel
- ADTSMW66 -T/R: 2000 pcs/reel
- ADTSMW67 -T/R: 900 pcs/reel
- ADTSMW68 -T/R: 2000 pcs/reel
- ADTSMW69 -T/R: 1900 pcs/reel

Tube: 75 pcs/tube

- ADTSJW64 -T/R: 900 pcs/reel
- ADTSJW65 -T/R: 1800 pcs/reel
- ADTSJW66 -T/R: 1900 pcs/reel
- ADTSJW67 -T/R: 900 pcs/reel
- ADTSJW68 -T/R: 2700 pcs/reel
- ADTSJW69 -T/R: 1800 pcs/reel

Mouser Electronics

Authorized Distributor

Click to View Pricing, Inventory, Delivery & Lifecycle Information:

[Apem:](#)

[ADTSHW24NQB](#)