

Click [here](#) for production status of specific part numbers.

## MAX22700–MAX22702 Evaluation Kits

Evaluates: MAX22700D–MAX22702D  
MAX22700E–MAX22702E

### General Description

The MAX22700–MAX22702 evaluation kits (EV kits) provide a proven design to evaluate the MAX22700–MAX22702 family of single-channel isolated gate drivers with ultra-high common-mode transient immunity (CMTI) of 300kV/μs (typ). Two identical channels (devices) are included on the EV kit in order to demonstrate the very tight part-to-part propagation delay matching of 2ns (max) over the -40°C to +125°C operating temperature range.

Two types of evaluation kits, MAX22701EVKIT# and MAX22702EVKIT#, are available to support variants with different B-side options, gate driver common pin GNDB (MAX22700), Miller Clamp pin (MAX22701), and adjustable undervoltage-lockout pin (MAX22702). In addition, both EV kits support variants with different A-side options, differential inputs (D versions), or a single-ended input with an enable pin (E versions). Both evaluation boards come with the narrow-body 8-pin SOIC package type. See [Table 1](#) for EV kit options.

The MAX22701EVKIT# is fully assembled and tested, and comes populated with the MAX22701EASA+ (see [Figure 1](#)). This board also supports the MAX22701DASA+, but requires the user to replace U1 and U2.

The MAX22702EVKIT# is fully assembled and tested, and comes populated with the MAX22702EASA+ (see [Figure 2](#)). This board also supports the MAX22700DASA+, MAX22700EASA+, and MAX22702DASA+ if the user replaces U1, U2, and necessary external components on the B side. See [Table 3](#) and [Evaluate MAX22700 on MAX22702EVKIT#](#) section for details.

The EV kits should be powered from multiple independent isolated power supplies as required by the different power domains. The A side of the MAX22700–MAX22702 family has a nominal supply-voltage range from 3V to 5.5V. The B side has a nominal supply-voltage range of 13V to 36V or 6V to 36V depending upon the target device. For evaluating the electrical parameters of the devices without any isolation between the two sides and two devices, a common ground can be shared among different power domains.

**Note:** When ordering an EV kit, if the desired device is not the MAX22701EASA+ or the MAX22702EASA+, request samples of the desired MAX22700–MAX22702 IC that can be soldered to the PCB.

### Features

- 2 EV Kits to Support 3 Output Options: GNDB, Miller Clamp, or Adjustable UVLO
- 2 Input Configurations: Single-Ended with Enable, or Differential
- 2 Identical Channels Allowing Propagation Delay Matching Measurements
- 2 Calibration Channels for Precision Propagation Delay Measurements
- SMA Connectors and Terminal Blocks for Easy Connection to External Equipment
- Wide Power Supply Voltage Range from 3V to 5.5V (A Side) and 13V to 36V (B Side)
- Guaranteed Up to 3kVRMS Isolation for 60s
- -40°C to +125°C Temperature Range
- Proven PCB Layout

[Ordering Information](#) appears at end of data sheet.

MAX22700–MAX22702  
Evaluation Kits

Evaluates: MAX22700D–MAX22702D  
MAX22700E–MAX22702E

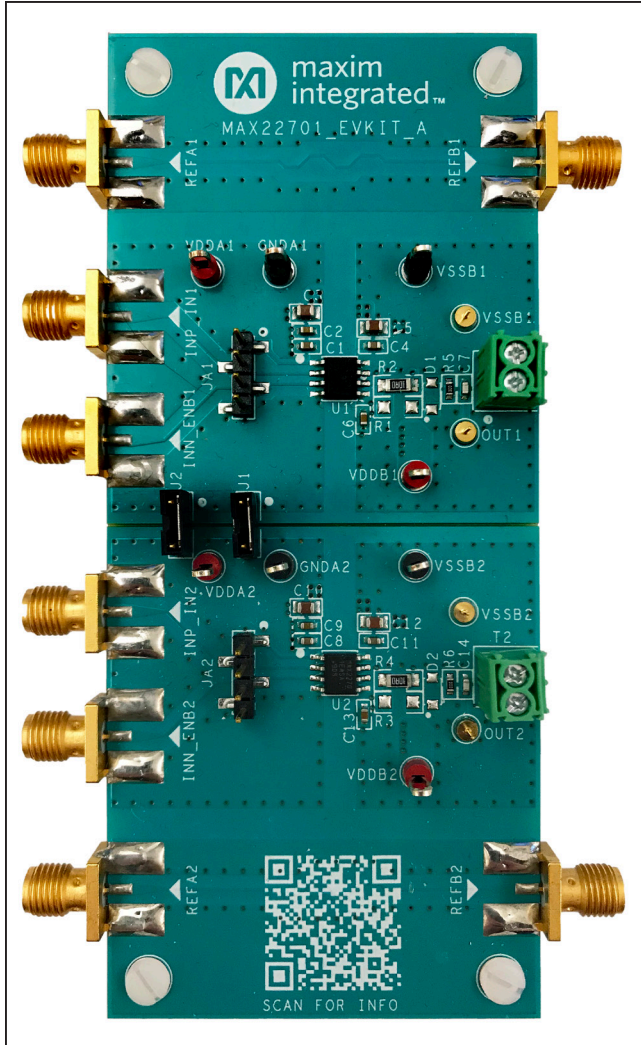

Figure 1. MAX22701EVKIT#

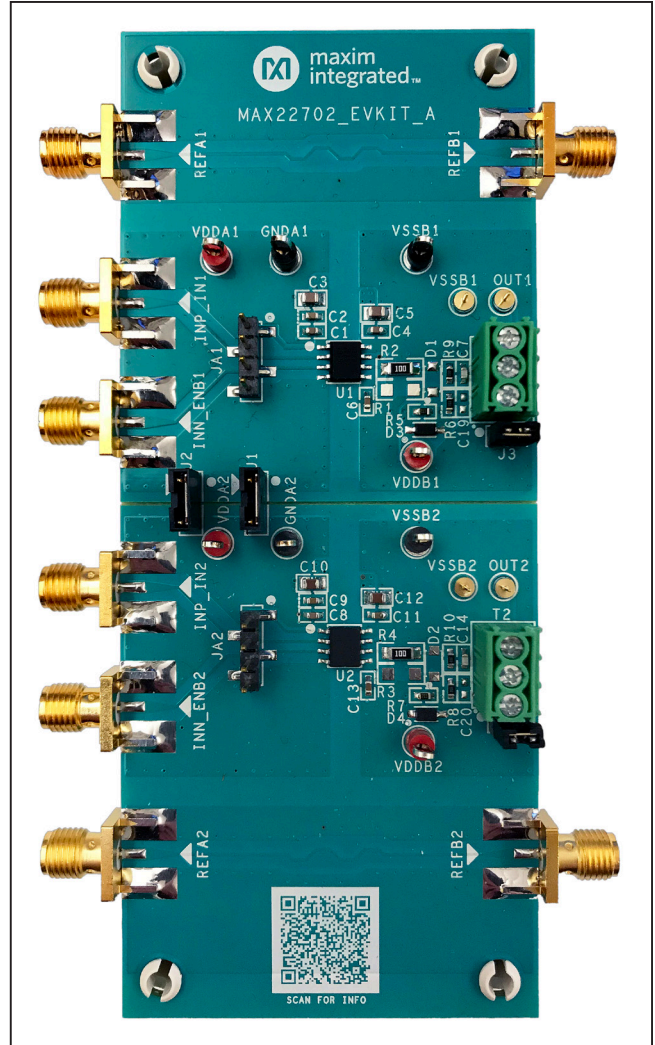

Figure 2. MAX22702EVKIT#

Table 1. EV Kit Options

EVKIT PART #	DEFAULT DEVICE	PACKAGE TYPE	POPULATED IC
MAX22701EVKIT#	MAX22701EASA+	8-SOIC Narrow-Body	Single-Ended Inputs with Miller Clamp on side B
MAX22702EVKIT#	MAX22702EASA+	8-SOIC Narrow-Body	Single-Ended Inputs with Adjustable UVLO on side B

# MAX22700–MAX22702 Evaluation Kits

Evaluates: MAX22700D–MAX22702D  
MAX22700E–MAX22702E

## Quick Start

### Required Equipment

- MAX22701EVKIT# with MAX22701EASA+ as U1 and U2, or MAX22702EVKIT# with MAX22702EASA+ as U1 and U2
- One DC power supply with an output range up to 5.5V
- Two DC power supplies with an output range up to 36V
- Signal/function generator
- Oscilloscope

### Procedure

The MAX22701 and MAX22702 EV kits are fully assembled and ready for evaluation. Follow the steps below to verify board functionality:

- 1) Verify jumper settings. See [Table 2](#) for all shunt positions.
  - J1 and J2 are closed.
  - For the MAX22702 EV kit, J3 and J4 are closed.
- 2) Connect the JA1 pin 3 (U1  $\overline{EN}$ ) and pin 4 (GNDA1) together, and the JA2 pin 3 (U2  $\overline{EN}$ ) and pin 4 (GNDA2) together using shunts or jump wires to always enable the U1 and U2 devices.
- 3) Connect a DC power supply between the EV kit VDDA1 and GNDA1 test points. Set the output between 3V and 5.5V.
- 4) Connect one DC power supply between the EV kit VDDB1 and VSSB1 test points, and another DC power supply between VDDB2 and VSSB2 test points.
- 5) MAX22701 EV kit: set both DC power supply outputs between 13V and 36V.  
MAX22702 EV kit: set both DC power supply outputs between 6V and 36V.
- 6) Enable all three power supplies.  
**Note:** *It is also possible to power the EV kits from a single power supply to test electrical parameters, but this invalidates the digital isolation between the A side and the B side of the IC, and the isolation between U1 and U2.*
- 7) Connect the signal/function generator output to SMA connector INP\_IN1. Set the function generator output to be a square wave with the amplitude of VDDA, 10kHz frequency, and 50% duty cycle. Enable the function generator output.
- 8) Observe the B-side output voltage on the OUT1 test point to be a square wave with the amplitude of VDDB, 10kHz frequency, and 50% duty cycle.
- 9) To measure the propagation delay matching between U1 and U2, connect the function generator output to both SMA connectors INP\_IN1 and INP\_IN2. Configure the output to be a square wave with the amplitude of VDDA, 10kHz frequency, and 50% duty cycle. Observe the propagation delay skew between the OUT1 test point and OUT2 test point.  
**Note:** *When connecting one scope probe between the OUT1 and VSSB1 test points and another scope probe between the OUT2 and VSSB2 test points, VSSB1 and VSSB2 are shorted together through the oscilloscope, which invalidates the isolation between U1 and U2. Make sure that VSSB1 and VSSB2 are safe to be shorted together when probing OUT1 and OUT2 using the same oscilloscope.*

**Table 2. MAX22701 and MAX22702 EV Kits Connectors and Shunt Positions**

CONNECTOR	SHUNT POSITION	DESCRIPTION
<b>SIDE A</b>		
J1	1-2*	Connect U1 GNDA and U2 GNDA
	Open	Disconnect U1 GNDA and U2 GNDA
J2	1-2*	Connect U1 V <sub>DDA</sub> and U2 V <sub>DDA</sub>
	Open	Disconnect U1 V <sub>DDA</sub> and U2 V <sub>DDA</sub>
JA1	1	Test point or input header for U1 V <sub>DDA</sub>
	2	Test point or input header for U1 INP (D versions) or IN (E versions); same as INP_IN1 SMA connector
	3	Test point or input header for U1 INN (D versions) or $\overline{EN}$ (E versions); same as INN_ENB1 SMA connector
	4	Test point or input header for U1 GNDA
JA2	5	Test point or input header for U2 V <sub>DDA</sub>
	6	Test point or input header for U2 INP (D versions) or IN (E versions); same as INP_IN2 SMA connector
	7	Test point or input header for U2 INN (D versions) or $\overline{EN}$ (E versions); same as INN_ENB2 SMA connector
	8	Test point or input header for U2 GNDA
INP_IN1	n/a	SMA connector for U1 INP input (D versions) or IN input (E versions)
INN_ENB1	n/a	SMA connector for U1 INN input (D versions) or $\overline{EN}$ input (E versions)
INP_IN2	n/a	SMA connector for U2 INP input (D versions) or IN input (E versions)
INN_ENB2	n/a	SMA connector for U2 INN input (D versions) or $\overline{EN}$ input (E versions)
<b>SIDE B</b>		
T1	1	(MAX22701 EV kit) Test point or connector for U1 output
		(MAX22702 EV kit) Test point or connector for U1 adjustable UVLO resistor-divider reference ground (MAX22702), or U1 GNDB (MAX22700); Connect to the external power transistor source pin
	2	(MAX22701 EV kit) Test point or connector for U1 V <sub>SSB</sub>
T2	1	(MAX22701 EV kit) Test point or connector for U2 output
		(MAX22702 EV kit) Test point or connector for U2 adjustable UVLO resistor-divider reference ground (MAX22702), or U2 GNDB (MAX22700); Connect to the external power transistor source pin
	2	(MAX22701 EV kit) Test point or connector for U2 V <sub>SSB</sub>
J3	1-2*	(MAX22702 EV kit only) Connect U1 V <sub>SSB</sub> and U1 GNDB (MAX22700) or U1 adjustable UVLO resistor-divider reference ground (MAX22702)
	Open	(MAX22702 EV kit only) Disconnect U1 V <sub>SSB</sub> and U1 GNDB (MAX22700) or U1 adjustable UVLO resistor-divider reference ground (MAX22702)
J4	1-2*	(MAX22702 EV kit only) Connect U2 V <sub>SSB</sub> and U2 GNDB (MAX22700) or U2 adjustable UVLO resistor-divider reference ground (MAX22702)
	Open	(MAX22702 EV kit only) Disconnect U2 V <sub>SSB</sub> and U2 GNDB (MAX22700) or U2 adjustable UVLO resistor-divider reference ground (MAX22702)

\*Default configuration

**Table 3. MAX22701 and MAX22702 EV Kits Board Configurations**

COMPONENTS	CONFIGURATIONS					
	MAX22700D	MAX22700E	MAX22701D	MAX22701E	MAX22702D	MAX22702E
<b>SIDE A</b>						
INP_IN1, INP_IN2	INP	IN	INP	IN	INP	IN
INN_ENB1, INN_ENB2	INN	$\overline{\text{EN}}$	INN	$\overline{\text{EN}}$	INN	$\overline{\text{EN}}$
JA1 PIN 2, JA2 PIN 2	INP	IN	INP	IN	INP	IN
JA1 PIN 3, JA2 PIN 3	INN	$\overline{\text{EN}}$	INN	$\overline{\text{EN}}$	INN	$\overline{\text{EN}}$
<b>SIDE B, MAX22701EVKIT#</b>						
T1 PIN1, T2 PIN 1	–	–	Output	Output	–	–
<b>SIDE B, MAX22702EVKIT#</b>						
T1 PIN 1, T2 PIN 1	GNDB	GNDB	–	–	ADJ Reference	ADJ Reference
T1 PIN 2, T2 PIN 2	Output	Output	–	–	Output	Output
R5, R7	DNI	DNI	–	–	20k $\Omega$	20k $\Omega$
D3, D4	DNI	DNI	–	–	6.2V Zener Diode	6.2V Zener Diode
R6, R8	0 $\Omega$	0 $\Omega$	–	–	110k $\Omega$	110k $\Omega$

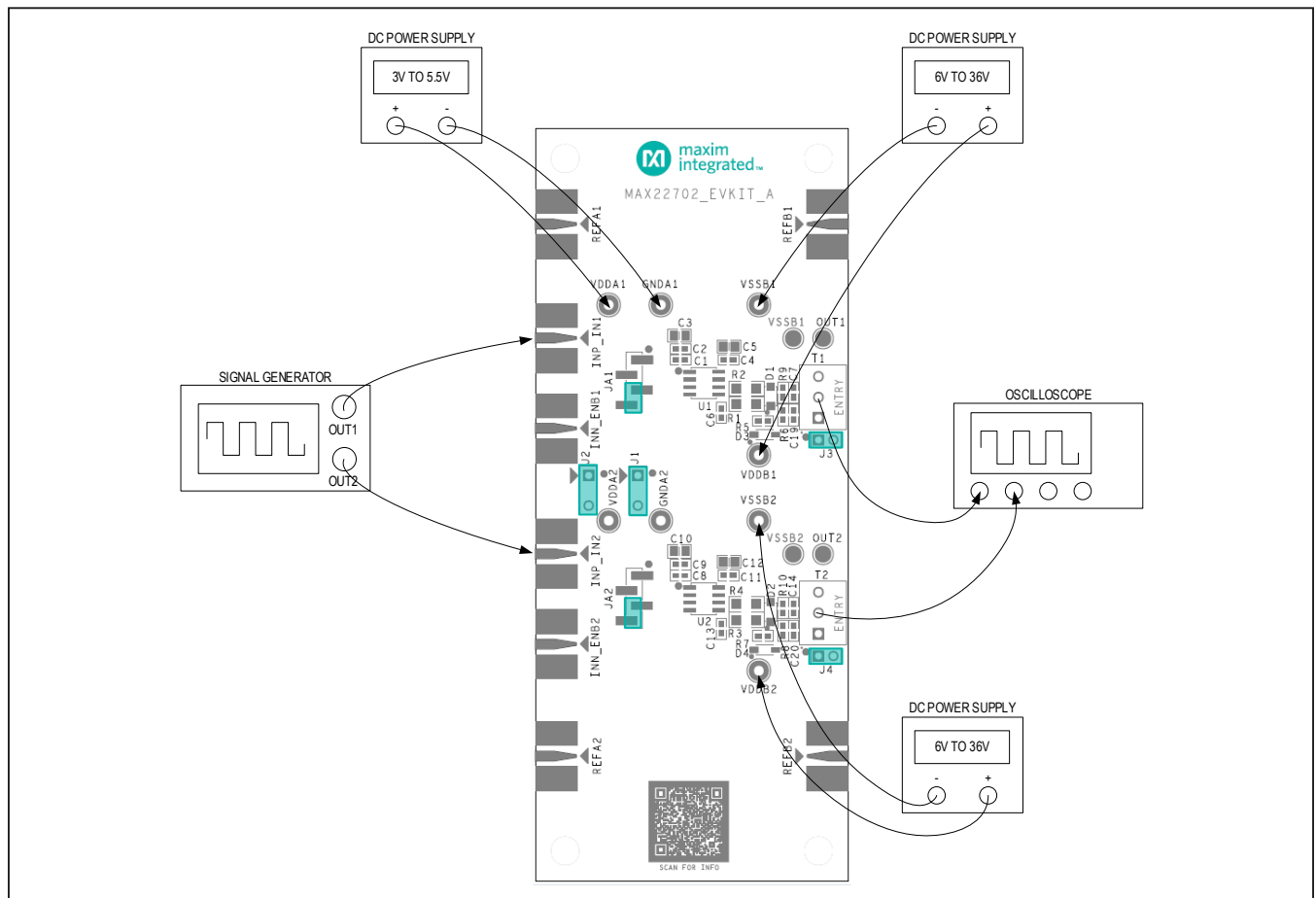

Figure 3. MAX22701 and MAX22702 EV Kits Typical Test Setup

## MAX22700–MAX22702 Evaluation Kits

### Detailed Description of Hardware

The MAX22700–MAX22702 EV kits allow the user to evaluate the features of the MAX22700–MAX22702 ultra-high CMTI isolated gate drivers.

#### Power Supplies and Isolation

Two identical channels (U1 and U2) are included on the EV kits and are fully isolated with each other. The A side and the B side of each device are also isolated to demonstrate the isolation feature of the devices.

Power to the MAX22701 or MAX22702 device is derived from two external sources. The A-side supply voltage range is between 3V and 5.5V, and the B-side supply voltage range is between 13V and 36V if the devices under evaluation are the MAX22700 and MAX22701, and between 6V and 36V if the device under evaluation is the MAX22702. Connect the A-side supply between VDDA and GNDA test points and connect the B-side supply between VDDB and VSSB test points. Each supply can be set independently and can be present over the entire voltage range regardless of the level or presence of the other supply.

The A side of both U1 and U2 devices can be powered from the same source when both J1 and J2 jumpers are installed. This is useful when both device inputs are driven from the same signal generator. In this case, the isolation between the U1 A side and the U2 A side no longer exists. The isolation between the U1 B side and the U2 B side and between the A side and the B side of each device is still intact. Refer to [Figure 3](#) for a typical test setup diagram.

#### Decoupling Capacitors

The VDDA power supply of both U1 and U2 are decoupled with 1000pF, 0.1μF and 1μF low-ESR and low-ESL ceramic capacitors, which are placed close to the VDDA pin of the device and are in parallel with each other.

The VDDB power supply of both U1 and U2 are decoupled with 1000pF, 0.1μF and 1μF low-ESR and low-ESL ceramic capacitors with 50V voltage rating in parallel with each other. The 1000pF and 1μF capacitors are placed close to the VSSB pin and the 0.1μF capacitor is placed close to the VDDB pin. An additional 10μF bulk capacitor is also included between the VDDB and VSSB pins to reduce the load current transient on the B-side supply. Refer to the [MAX22701 EV Kit PCB Layout Diagrams](#) and the [MAX22702 EV Kit PCB Layout Diagrams](#) for details.

## Evaluates: MAX22700D–MAX22702D MAX22700E–MAX22702E

### I/O Connections

Two SMA connectors (INP\_IN and INN\_ENB) are provided on the A side of each device to allow easy connections to signal generator(s). Depending on the U1 and U2 devices installed on the board, they can be connected to differential signals with opposite phases (MAX2270\_D versions) or a single-ended signal with an enable signal (MAX2270\_E versions).

To accommodate different B-side configurations of the MAX22700–MAX22702 IC family, different terminal blocks (T1 and T2) are provided on the B side of the MAX22701 and MAX22702 EV kits. On the MAX22701 EV kit, two-pin connectors are provided, where pin 1 is the output and pin 2 is U1 or U2 VSSB. On the MAX22702 EV kit, three-pin connectors are provided. Pin 1 is the external resistor-divider reference ground for adjustable UVLO if the MAX22702 IC devices are installed as U1 and U2. If the MAX22700 IC devices are installed as U1 and U2, pin 1 is connected to GNDB. Regardless of the U1 and U2 devices, pin 2 is the output and pin 3 is U1 or U2 VSSB. Refer to [Table 2](#) for connector positions and [Table 3](#) for board configurations based on different U1 and U2 devices.

### Shunt Positions

Install the jumpers on J1 and J2 to connect U1 VDDA and U2 VDDA, and U1 GNDA and U2 GNDA when a single power supply is used to drive the A side of both devices.

On the MAX22702 EV kit, jumpers J3 and J4 are provided to connect VSSB supply and the adjustable UVLO resistor-divider reference ground (MAX22702), or VSSB supply and GNDB (MAX22700). This is useful when evaluating the electrical performance of the devices without power transistors. The J3 and J4 jumpers should be removed when driving the external power transistors using the EV kit. The adjustable UVLO resistor-divider reference ground or GNDB should be connected to the external power transistor source pin. Refer to the *MAX22700–MAX22702 IC data sheet* for more details. See [Table 2](#) for all shunt positions.

### Calibration Channels

Two reference channels (REFA1–REFB1, REFA2–REFB2) are implemented on the EV kits to help calibrate the test setup for timing measurements such as propagation delay. Measure the propagation delay ( $t_{PD\_REF}$ ) using the reference channel first to determine the delay introduced by the test setup. Measure the propagation delay ( $t_{PD\_ISO}$ ) again using either U1 or U2 channel. The calibrated propagation delay is  $t_{PD\_ISO} - t_{PD\_REF}$ .

## MAX22700–MAX22702 Evaluation Kits

The U1 and U2 channels are made identical to demonstrate the tight part-to-part propagation delay skew of the MAX22700–MAX22702 family. Apply the input signals to both U1 and U2 inputs and measure the propagation delay skew on the outputs (OUT1 and OUT2). Care should be taken that the connections between the signal generator and the inputs, and the connections between the outputs and the oscilloscope are made identical to minimize the skew introduced by the test setup. Refer to the EV kit typical test setup diagram as shown in [Figure 3](#).

### Gate Driver Output Resistors

External series resistors between the MAX22700–MAX22702 IC output and the gate of the power transistor are required in gate driver applications. These resistors control the turn-on and turn-off times of the power transistor.

Both MAX22701 and MAX22702 EV kits come populated with a 10Ω output resistor (R2 for U1, R4 for U2). In parallel to this 10Ω resistor, a resistor footprint (R1 for U1, R3 for U2) in series with a diode footprint (D1 for U1, D2 for U2) are provided on the EV kits to allow different rise and fall times of the output. These resistors can be modified by the user to configure turn-on and turn-off times of the output based on the application.

The EV kits also come populated with a 220pF load capacitor (C7 for U1, C14 for U2) on each output. The user can replace this capacitor to emulate the required gate capacitance of the external power transistor.

A 0Ω resistor (R5 and R6 on the MAX22701EVKIT#, R9 and R10 on the MAX22702EVKIT#) is included between the output resistor and the load capacitor, which can be replaced by a ferrite bead to help minimize ringing on the output signal.

## Evaluates: MAX22700D–MAX22702D MAX22700E–MAX22702E

### Evaluate MAX22700 on MAX22702EVKIT#

The MAX22702 EV kit is designed to evaluate all MAX22700 and MAX22702 devices. The MAX22700 provides a common ground pin (GNDB) on the driver side while the MAX22702 features an adjustable B-side UVLO (ADJ) to accommodate UVLO requirements of different types of power transistors. Due to this difference, the external components need to be configured differently when using the MAX22702 EV kit to evaluate the MAX22700.

By default, the MAX22702EVKIT# comes populated with the MAX22702EASA+. Resistor-dividers formed by R5 and R6 for U1, and R7 and R8 for U2 are implemented on the board to set the B-side UVLO to 13V. The zener diodes D3 for U1 and D4 for U2 prevent the voltage difference between  $V_{DDB}$  supply and ADJ being more than 6V, which violates the Absolute Maximum Ratings for the ADJ pin.

To evaluate the MAX22700 devices on the MAX22702 EV kit, U1 and U2 need to be replaced with the MAX22700. R5, R7, D3 and D4 need to be removed. R6 and R8 need to be replaced with 0Ω resistors in order to connect the GNDB pin of the MAX22700 directly to the terminal blocks (T1 and T2). When installing U1 and U2, make sure pin 1 of the device is mounted onto pin 1 of U1 and U2 on the PCB. Pin 1 is located at the upper left corner of U1 and U2, denoted by a white dot on the silkscreen. Refer to [Table 3](#) for different board configurations.

The MAX22701 EV kit is designed to evaluate the MAX22701 devices with Miller Clamp feature.

Refer to the [MAX22701 EV Kit Schematic](#) and the [MAX22702 EV Kit Schematic](#) for details.

## Ordering Information

PART	TYPE
MAX22701EVKIT#	EV Kit with installed MAX22701EASA+
MAX22702EVKIT#	EV Kit with installed MAX22702EASA+

#Denotes RoHS compliant.

MAX22700–MAX22702  
Evaluation Kits

Evaluates: MAX22700D–MAX22702D  
MAX22700E–MAX22702E

MAX22701 EV Kit Bill of Materials

ITEM	REF_DES		QTY	MFG PART #	MANUFACTURER	VALUE	DESCRIPTION
1	C1, C4, C8, C11		4	C0603H102J1GAC	KEMET	1000PF	CAPACITOR; SMT (0603); CERAMIC CHIP; 1000PF; 100V; TOL = 5%; MODEL = HT SERIES; TG = -55°C TO +200°C; TC = C0G
2	C2, C6, C9, C13		4	CC0603KRX7R0BB104; GRM188R72A104KA35; GCJ188R72A104KA01	YAGEO; MURATA;MURATA	0.1µF	CAPACITOR; SMT (0603); CERAMIC CHIP; 0.1µF; 100V; TOL = 10%; TG = -55°C TO +125°C; TC = X7R
3	C3, C5, C10, C12		4	C2012X7S2A105K125; GRJ21BC72A105KE11; CGA4J3X7S2A105K125AB; GRM21BC72A105KE01	TDK;MURATA; TDK;MURATA	1µF	CAPACITOR; SMT (0805); CERAMIC CHIP; 1µF; 100V; TOL = 10%; TG = -55°C TO +125°C; TC = X7S
4	C7, C14		2	C0603C221K1GAC	KEMET	220PF	CAPACITOR; SMT (0603); CERAMIC CHIP; 220PF; 100V; TOL = 10%; MODEL = C0G; TG = -55°C TO +125°C; TC = +
5	C15, C16		2	T591D106M050ATE090	KEMET	10µF	CAP; SMT (7343-31); 10µF; 20%; 50V; TANTALUM CHIP
6	GND A1, GND A2, VSSB1, VSSB2		4	5011	KEYSTONE	N/A	TEST POINT; PIN DIA = 0.125IN; TOTAL LENGTH = 0.445IN; BOARD HOLE = 0.063IN; BLACK; PHOSPHOR BRONZE WIRE SILVER PLATE FINISH;
7	INN_ENB1, INN_ENB2, INP_IN1, INP_IN2, REFA1, REFA2, REFB1, REFB2		8	142-0701-851	JOHNSON COMPONENTS	142-0701-851	CONNECTOR; END LAUNCH JACK RECEPTACLE; BOARDMOUNT; STRAIGHT THROUGH; 2PINS;
8	J1, J2		2	TSW-202-07-G-S	SAMTEC	TSW-202-07-G-S	CONNECTOR; MALE; THROUGH HOLE; SQUARE POST HEADER; STRAIGHT; 2PINS
9	JA1, JA2		2	" 5-146128-2"	TE CONNECTIVITY	" 5-146128-2"	CONNECTOR; HEADER ASSEMBLY; BREAKAWAY MALE; SMT; STRAIGHT; 4PINS
10	OUT1, OUT2, VSSB1_TP, VSSB2_TP		4	1508-0-57-15-00-00-03-0	MILL-MAX	N/A	TEST POINT; SMT; PIN DIA = 0.110IN; TOTAL LENGTH = 0.17IN
11	R2, R4		2	CRCW120610R0FKEBHP	VISHAY	10	RES; SMT (1206); 10; 1%; ±100PPM/°K; 0.75W ;
12	R5, R6		2	CRCW06030000Z0	VISHAY DALE	0	RESISTOR; 0603; 0Ω; 0%; JUMPER; 0.1W; THICK FILM
13	SU1, SU2		2	531230-4	TE CONNECTIVITY	531230-4	TEST POINT; ECONOMY SHUNT ASSEMBLY; STR; TOTAL LENGTH = 2IN; BLACK; CONTACT BASE MATERIAL= BERYLLIUM COPPER
14	T1, T2		2	1984617	PHOENIX CONTACT	1984617	CONNECTOR; FEMALE; SMT; PCB TERMINAL BLOCK; RIGHT ANGLE; 2PINS
15	U1, U2		2	MAX22701	MAXIM	MAX22701	EVKIT PART -IC; MAX22701; ULTRA-HIGH CMTI SILICON-CARBIDE (SiC) GATE DRIVER; PACKAGE OUTLINE: 21-0041; PACKAGE CODE: S8M+5; LAND PATTERN NO.: 90-0096; NSOIC8
16	VDDA1, VDDA2, VDD B1, VDD B2		4	5010	KEYSTONE	N/A	TEST POINT; PIN DIA = 0.125IN; TOTAL LENGTH = 0.445IN; BOARD HOLE = 0.063IN; RED; PHOSPHOR BRONZE WIRE SIL;
17	PCB		1	MAX22701	MAXIM	PCB	PCB:MAX22701
18	MTH1-MTH4	DNI	4	1902B	GENERIC PART	N/A	STANDOFF; FEMALE-THREADED; HEX; 4-40IN; 3/8IN; NYLON
19	MTH1-MTH4	DNI	4	P440.375	GENERIC PART	N/A	MACHINE SCREW; SLOTTED; PAN; 4-40IN; 3/8IN; NYLON
20	D1, D2	DNI	2	SL04	VISHAY	SL04	DIODE; SCH; SMT (DO-219AB); PIV = 40V; IF = 1.1A
21	R1, R3	DNI	2	CRCW12062R49FKEAHP	VISHAY	2.49	RES; SMT (1206); 2.49; 1%; ±100PPM/°K; 0.75W



# MAX22700–MAX22702 Evaluation Kits

# Evaluates: MAX22700D–MAX22702D MAX22700E–MAX22702E

## MAX22701 EV Kit Schematic

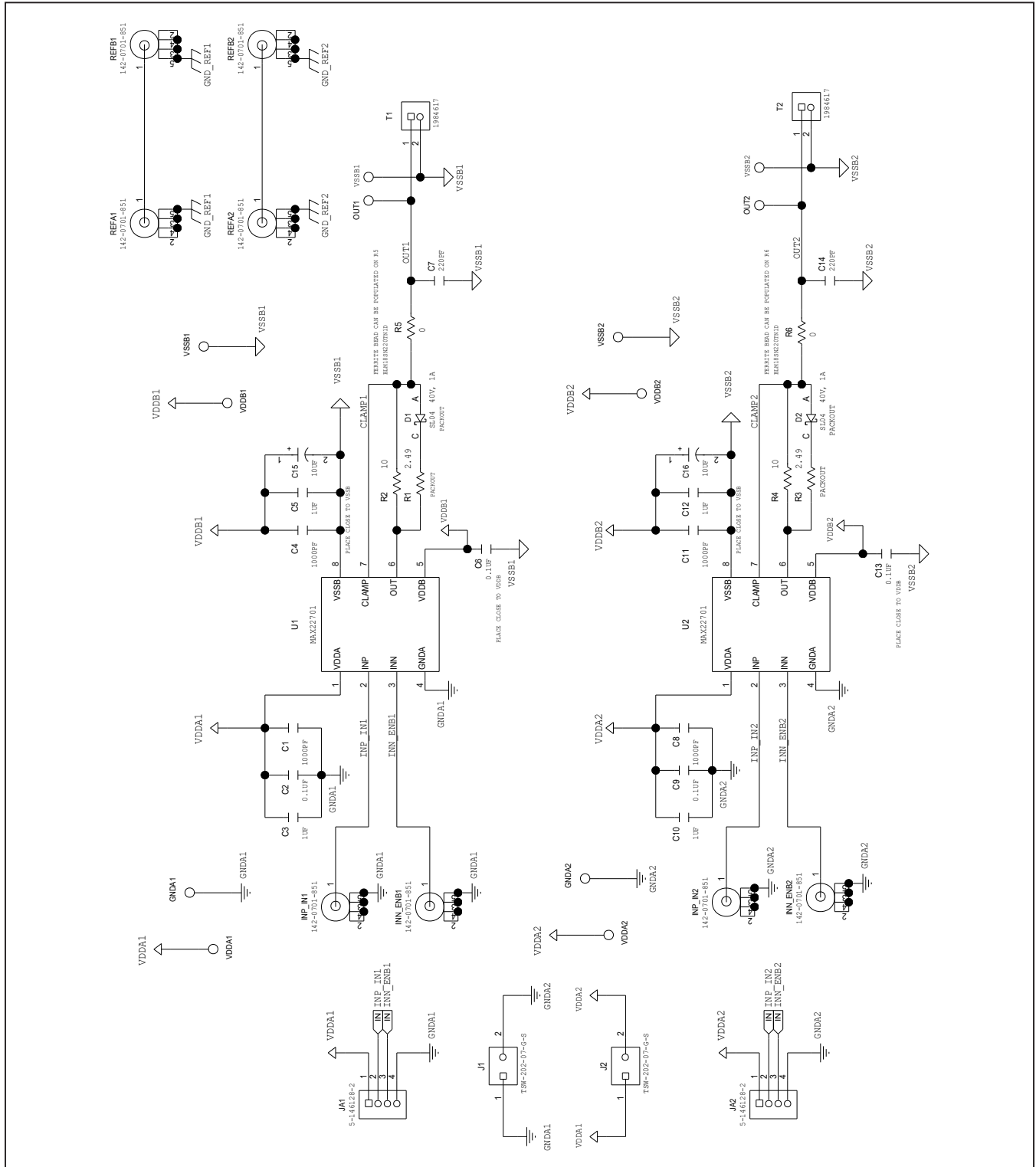

MAX22700–MAX22702  
Evaluation Kits

Evaluates: MAX22700D–MAX22702D  
MAX22700E–MAX22702E

MAX22701 EV Kit PCB Layout Diagrams

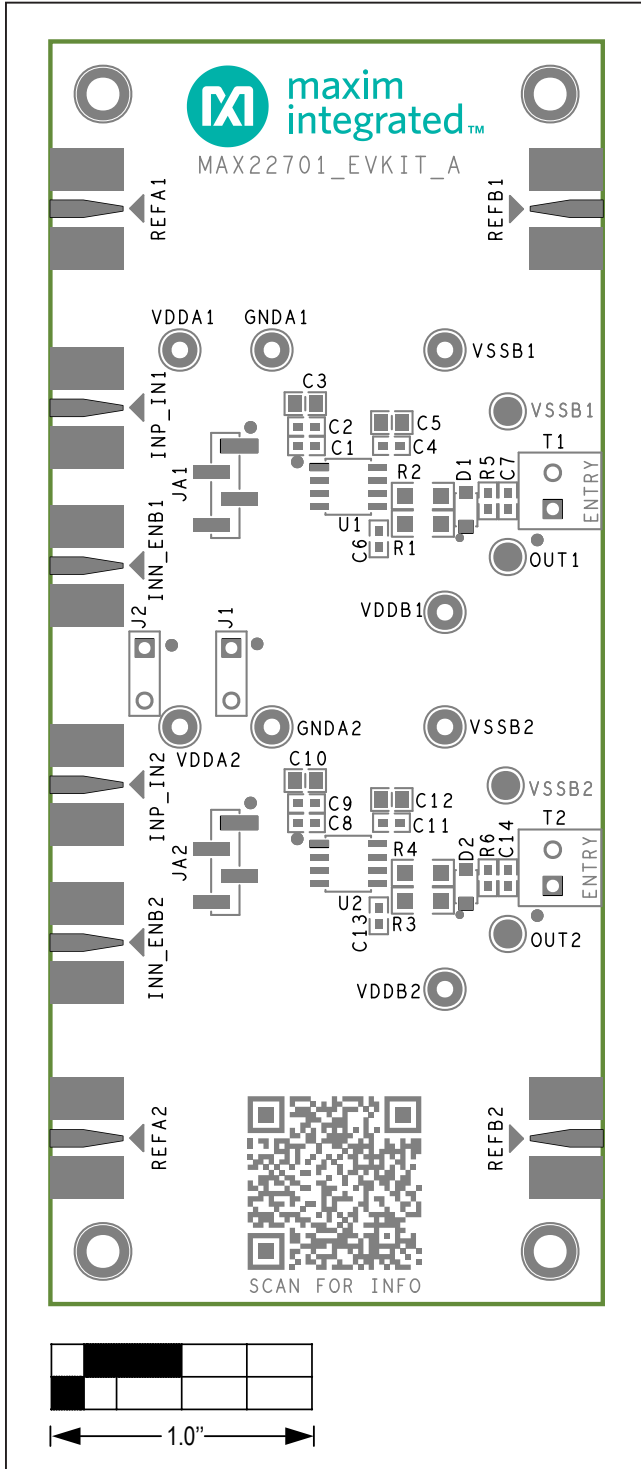

MAX22701 EV Kit PCB Layout—Top Silkscreen

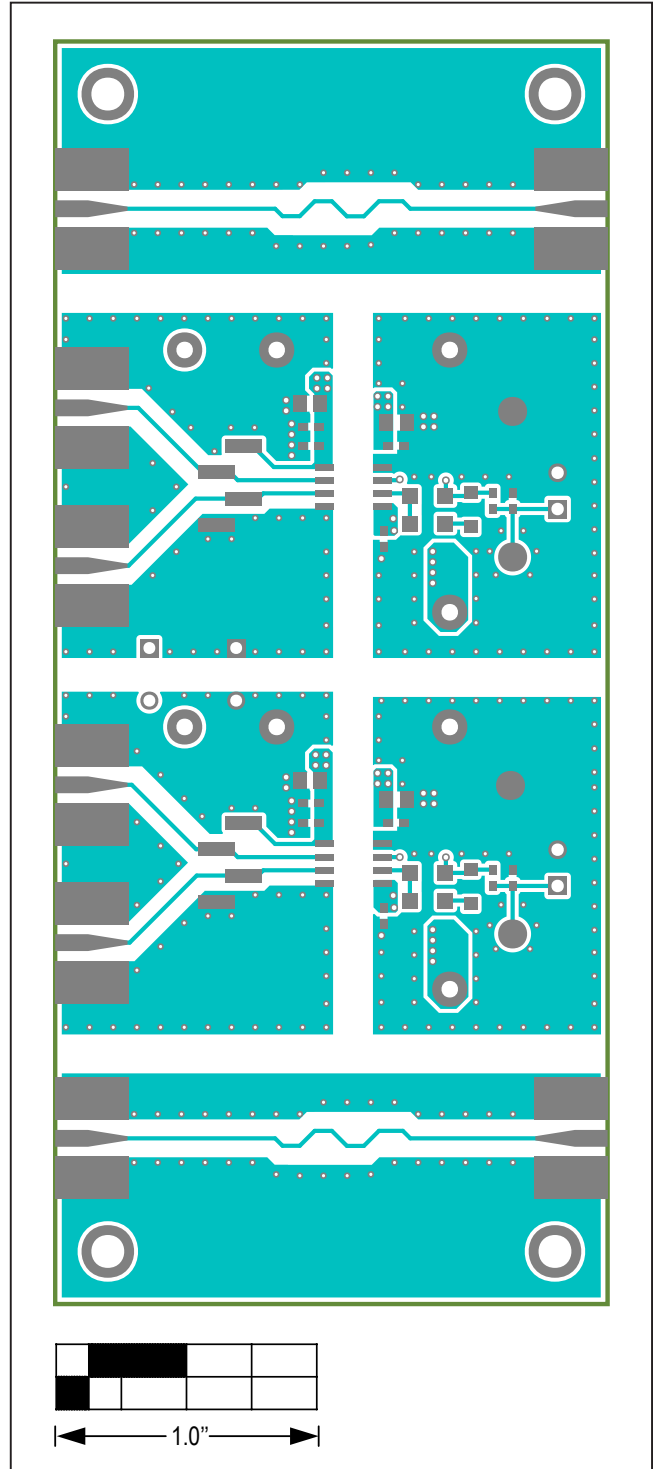

MAX22701 EV Kit PCB Layout—Top View

MAX22701 EV Kit PCB Layout Diagrams (continued)

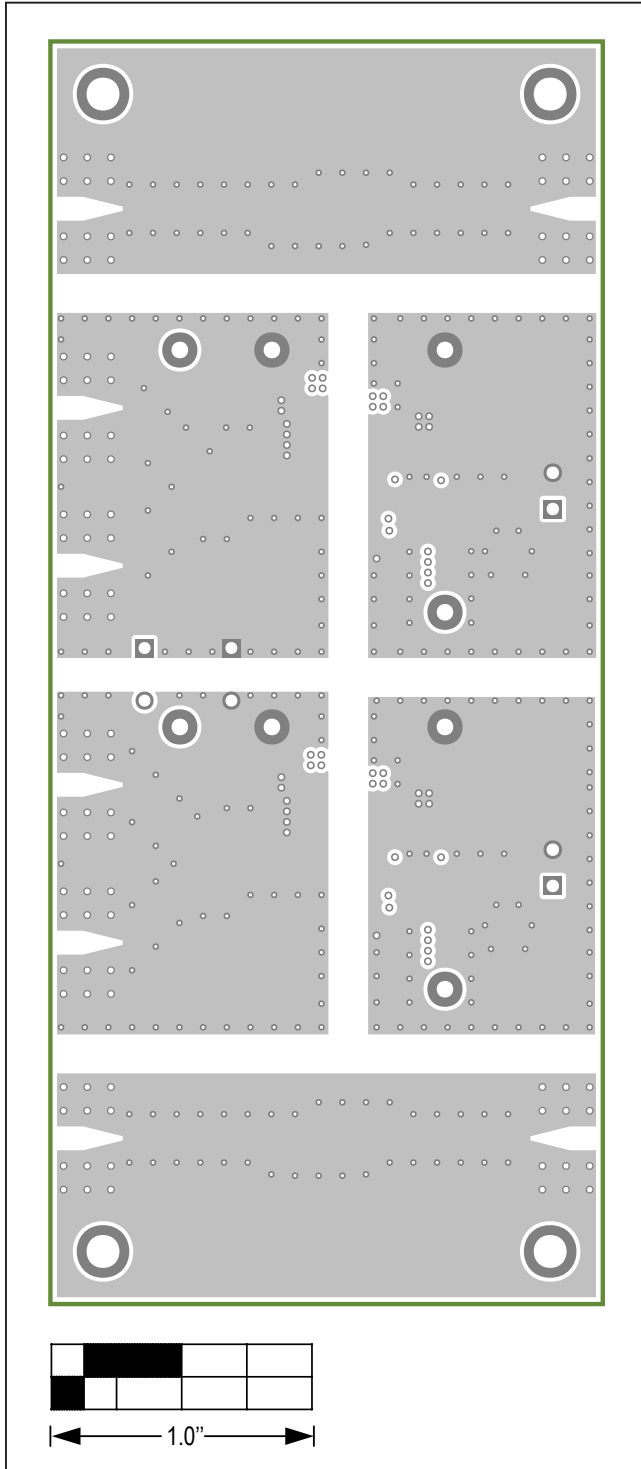

MAX22701 EV Kit PCB Layout—L2 GND

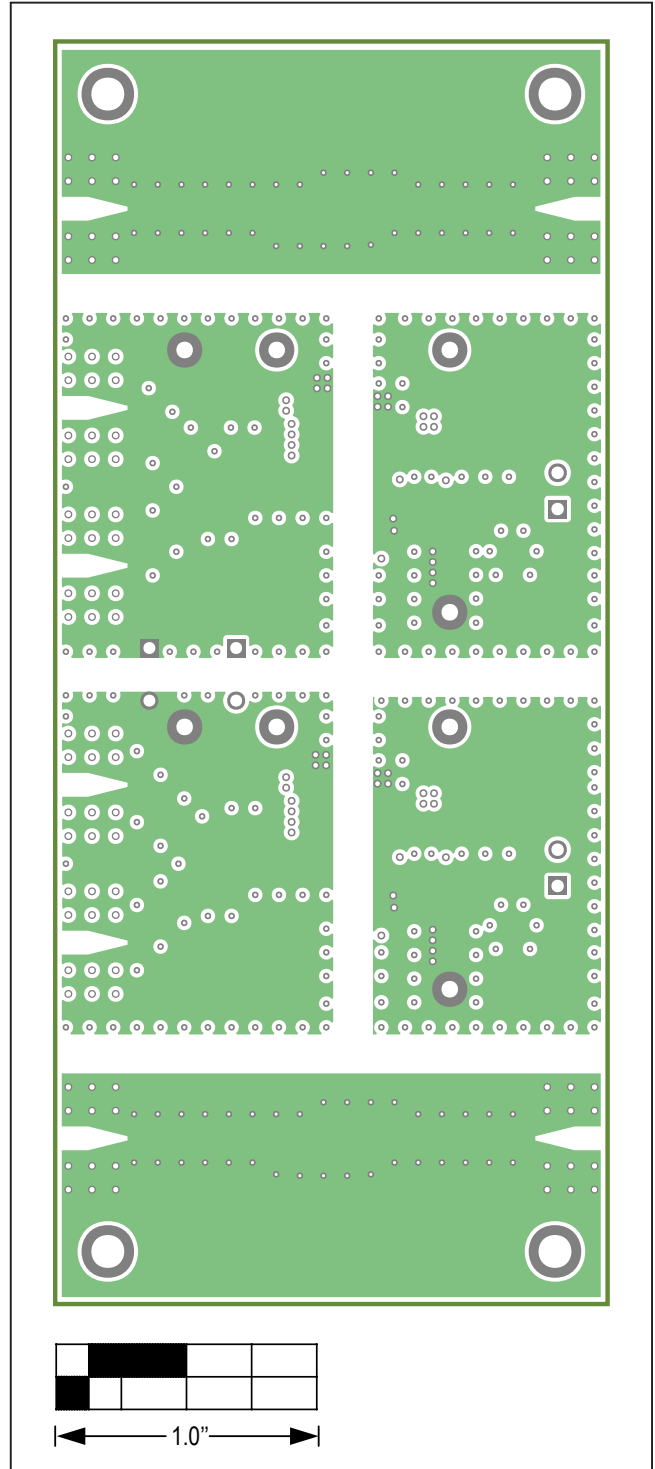

MAX22701 EV Kit PCB Layout—L3 PWR

MAX22701 EV Kit PCB Layout Diagrams (continued)

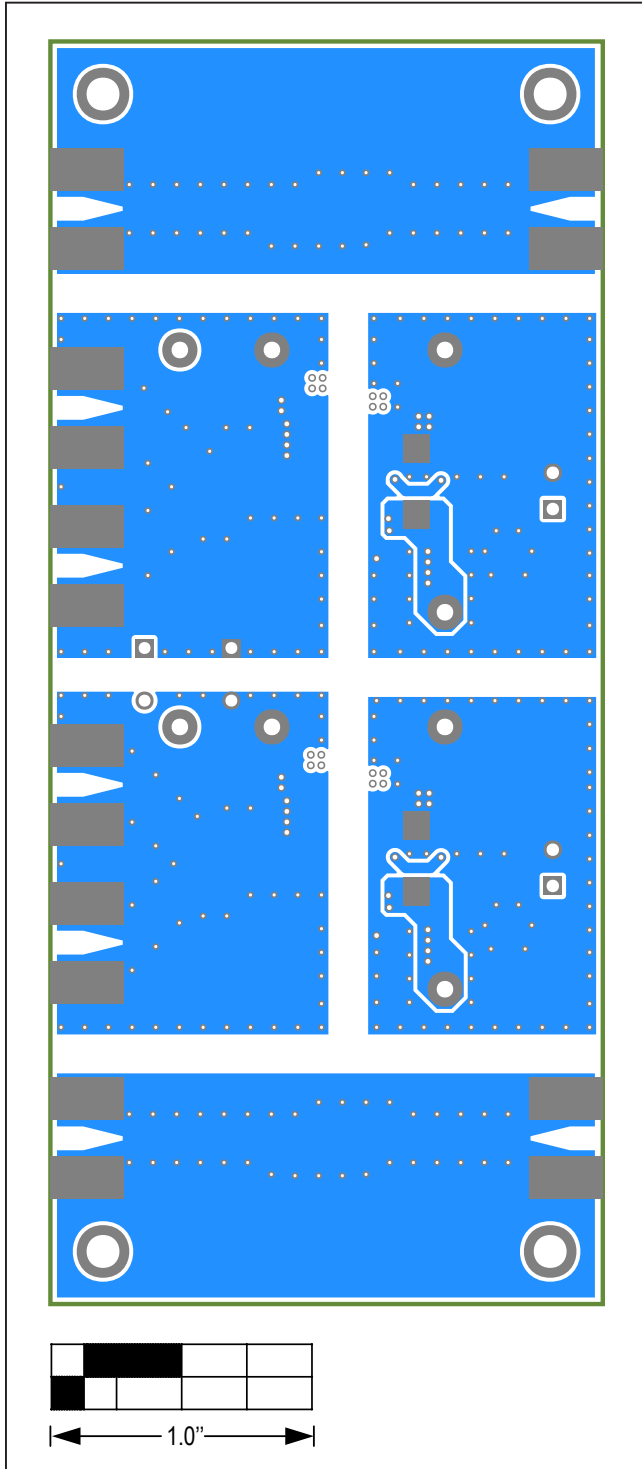

MAX22701 EV Kit—Bottom View

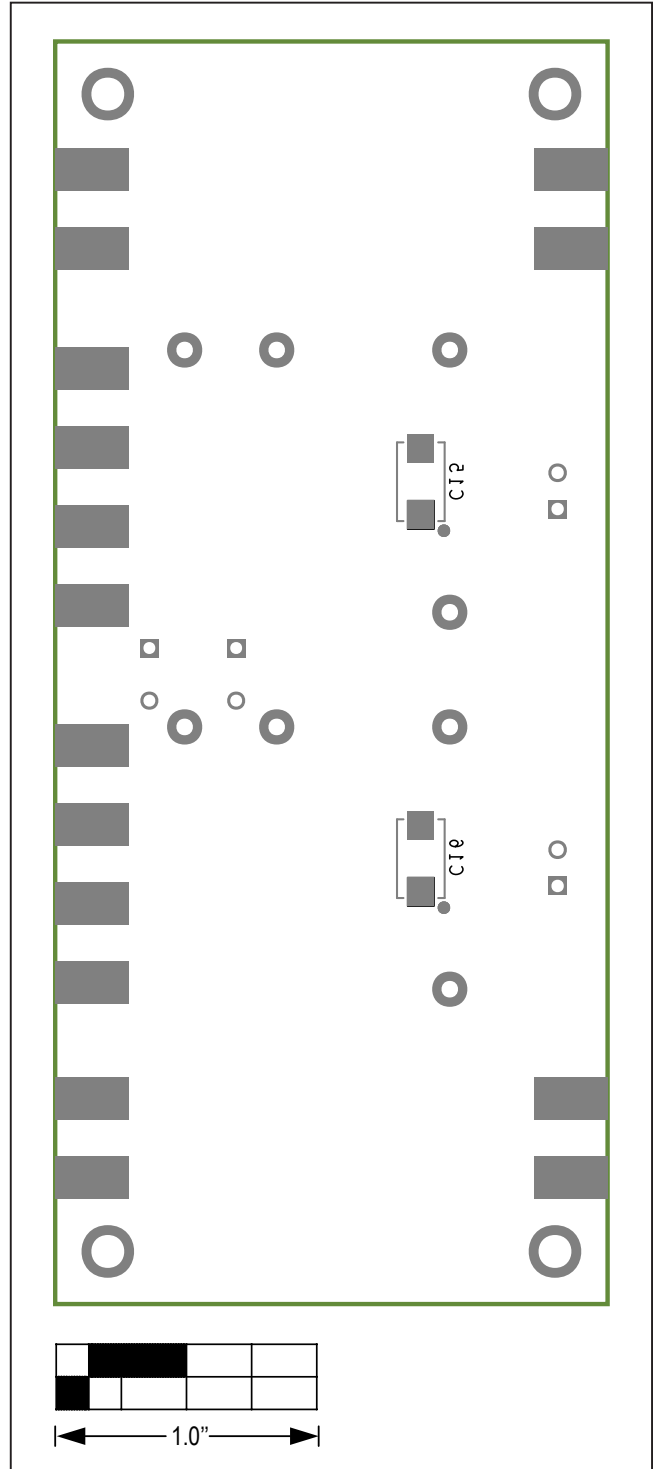

MAX22701 EV Kit PCB Layout—Bottom Silkscreen

MAX22700–MAX22702  
Evaluation Kits

Evaluates: MAX22700D–MAX22702D  
MAX22700E–MAX22702E

MAX22702 EV Kit Bill of Materials

ITEM	REF_DES		QTY	MFG PART #	MANUFACTURER	VALUE	DESCRIPTION
1	C1, C4, C8, C11		4	C0603H102J1GAC	KEMET	1000PF	CAPACITOR; SMT (0603); CERAMIC CHIP; 1000PF; 100V; TOL = 5%; MODEL = HT SERIES; TG = -55°C TO +200°C; TC = C0G
2	C2, C6, C9, C13		4	CC0603KRX7R0BB104; GRM188R72A104KA35; GCJ188R72A104KA01; HMK107B7104KA; 06031C104KAT2A	YAGEO;MURATA; MURATA;TAIYO YUDEN; AVX	0.1µF	CAPACITOR; SMT (0603); CERAMIC CHIP; 0.1µF; 100V; TOL = 10%; TG = -55°C TO +125 DEGC; TC = X7R
3	C3, C5, C10, C12		4	C2012X7S2A105K125AB; GRJ21BC72A105KE11; CGA4J3X7S2A105K125AB; GRM21BC72A105KE01	TDK;MURATA;TDK	1µF	CAPACITOR; SMT (0805); CERAMIC CHIP; 1µF; 100V; TOL = 10%; TG = -55°C TO +125°C; TC = X7S
4	C7, C14		2	C0603C221K1GAC	KEMET	220PF	CAPACITOR; SMT (0603); CERAMIC CHIP; 220PF; 100V; TOL = 10%; MODEL = C0G; TG = -55°C TO +125°C; TC = +
5	C15, C16		2	T591D106M050ATE090	KEMET	10µF	CAP; SMT (7343-31); 10µF; 20%; 50V; TANTALUM CHIP
6	D3, D4		2	MMSZ5234B-7-F	DIODES INCORPORATED	6.2V	DIODE; ZNR; SMT (SOD-123); VZ = 6.2V; IZ = 0.02A
7	GND A1, GND A2, VSSB1, VSSB2		4	5011	KEYSTONE	N/A	TEST POINT; PIN DIA = 0.125IN; TOTAL LENGTH = 0.445IN; BOARD HOLE = 0.063IN; BLACK; PHOSPHOR BRONZE WIRE SILVER PLATE FINISH;
8	INN_ENB1, INN_ENB2, INP_IN1, INP_IN2, REF A1, REF A2, REF B1, REF B2		8	142-0701-851	JOHNSON COMPONENTS	142-0701-851	CONNECTOR; END LAUNCH JACK RECEPTACLE; BOARD MOUNT; STRAIGHT THROUGH; 2PINS;
9	J1, J2		2	TSW-202-07-G-S	SAMTEC	TSW-202-07-G-S	CONNECTOR; MALE; THROUGH HOLE; SQUARE POST HEADER; STRAIGHT; 2PINS
10	J3, J4		2	PEC02SAAN	SULLINS	PEC02SAAN	CONNECTOR; MALE; THROUGH HOLE; BREAKAWAY; STRAIGHT; 2PINS
11	JA1, JA2		2	5-146128-2	TE CONNECTIVITY	5-146128-2	CONNECTOR; HEADER ASSEMBLY; BREAKAWAY MALE; SMT; STRAIGHT; 4PINS
12	MTH1-MTH4		4	9032	KEYSTONE	9032	MACHINE FABRICATED; ROUND-THRU HOLE SPACER; NO THREAD; M3.5; 5/8IN; NYLON
13	OUT1, OUT2, VSSB1_TP, VSSB2_TP		4	1508-0-57-15-00-00-03-0	MILL-MAX	N/A	TEST POINT; SMT; PIN DIA = 0.110IN; TOTAL LENGTH=0.17IN
14	R2, R4		2	CRCW120610R0FKEBHP	VISHAY	10	RES; SMT (1206); 10; 1%; ±100PPM/K; 0.75W ;
15	R5, R7		2	MCR03EZPF2002; ERJ-3EKF2002; CR0603-FX-2002ELF; CRCW060320K0FK	ROHM;PANASONIC; BOURNS; VISHAY DALE	20K	RESISTOR; 0603; 20KΩ; 1%; 100PPM; 0.10W; THICK FILM
16	R6, R8		2	CRCW0603110KFK	VISHAY DALE	110K	RESISTOR; 0603; 110K; 1%; 100PPM; 0.10W; THICK FILM
17	R9, R10		2	CRCW06030000Z0	VISHAY DALE	0	RESISTOR; 0603; 0Ω; 0%; JUMPER; 0.1W; THICK FILM
18	SU1, SU2		2	531230-4	TE CONNECTIVITY	531230-4	TEST POINT; ECONOMY SHUNT ASSEMBLY; STR; TOTAL LENGTH = 2IN; BLACK; CONTACT BASE MATERIAL= BERYLLIUM COPPER
19	SU3, SU4		2	S1100-B;SX1100-B; STC02SYAN	KYCON;KYCON; SULLINS ELECTRONICS CORP.	SX1100-B	TEST POINT; JUMPER; STR; TOTAL LENGTH = 0.24IN; BLACK; INSULATION = PBT; PHOSPHOR BRONZE CONTACT=GOLD PLATED
20	T1, T2		2	1984620	PHOENIX CONTACT	1984620	CONNECTOR; FEMALE; SMT; COMBICON COMPACT; RIGHT ANGLE; 3PINS
21	U1, U2		2	MAX22702	MAXIM	MAX22702	EVKIT PART -IC; MAX22702; ULTRA-HIGH CMTI SILICON-CARBIDE (SIC) AND GALLIUM NITRIDE (GAN) GATE DRIVER; PACKAGE OUTLINE: 21-0041; PACKAGE CODE: S8M+5; LAND PATTERN NO.: 90-0096; NSOIC8
22	VDDA1, VDDA2, VDD B1, VDD B2		4	5010	KEYSTONE	N/A	TEST POINT; PIN DIA = 0.125IN; TOTAL LENGTH=0.445IN; BOARD HOLE = 0.063IN; RED; PHOSPHOR BRONZE WIRE SIL;
23	PCB		1	MAX22702	MAXIM	PCB	PCB:MAX22702
24	D1, D2	DNI	2	SL04	VISHAY	SL04	DIODE; SCH; SMT (DO-219AB); PIV = 40V; IF = 1.1A
25	R1, R3	DNI	2	CRCW12062R49FKEAHP	VISHAY	2.49	RES; SMT (1206); 2.49; 1%; ±100PPM/K; 0.75W
26	C19, C20	DNP	0	N/A	N/A	OPEN	PACKAGE OUTLINE 0603 NON-POLAR CAPACITOR
27	C17, C18	DNP	0	N/A	N/A	OPEN	PACKAGE OUTLINE 0805 NON-POLAR CAPACITOR
<b>TOTAL</b>			<b>69</b>				

# MAX22700–MAX22702 Evaluation Kits

Evaluates: MAX22700D–MAX22702D  
MAX22700E–MAX22702E

## MAX22702 EV Kit Schematic

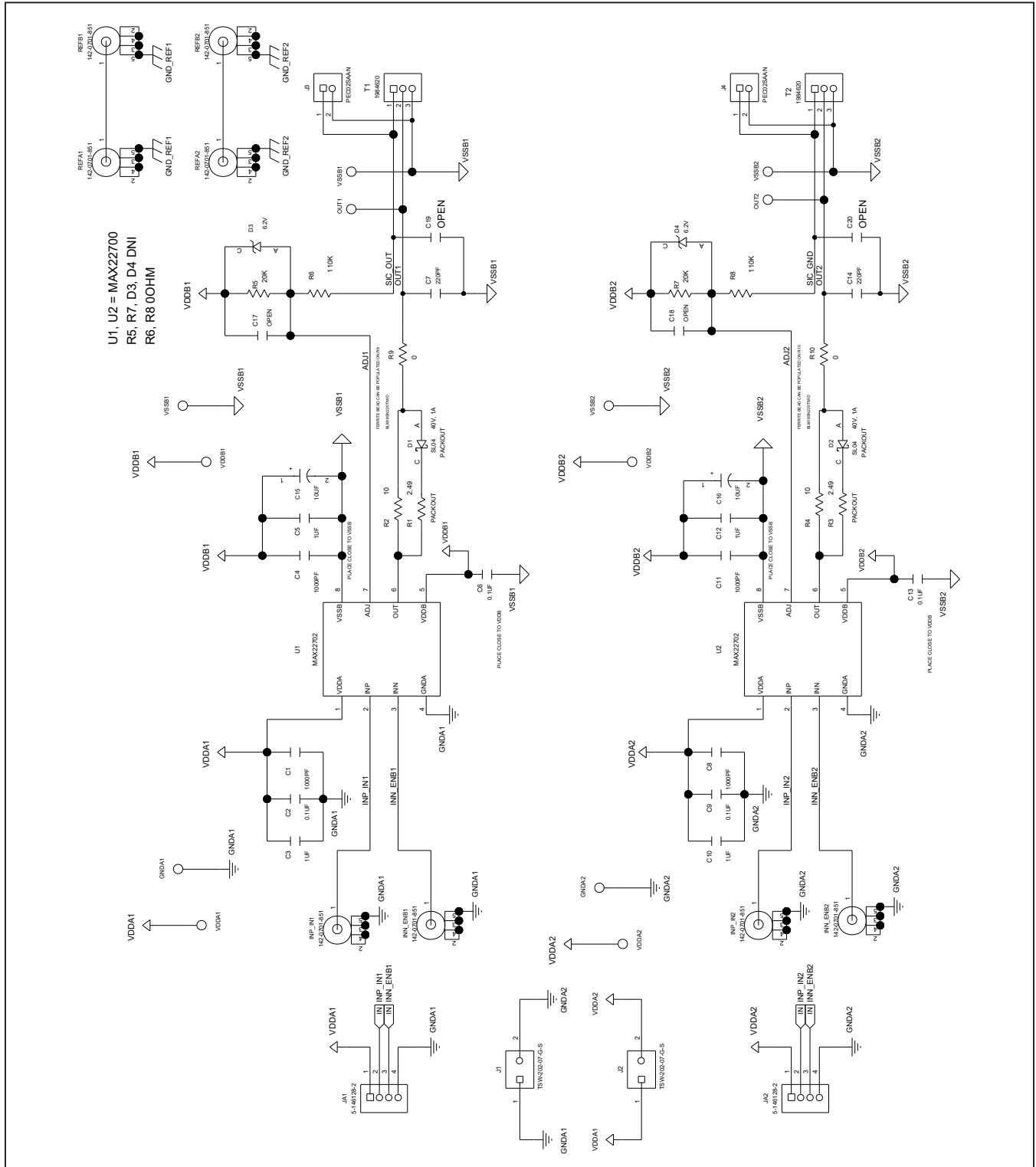

MAX22700–MAX22702  
Evaluation Kits

Evaluates: MAX22700D–MAX22702D  
MAX22700E–MAX22702E

MAX22702 EV Kit PCB Layout Diagrams

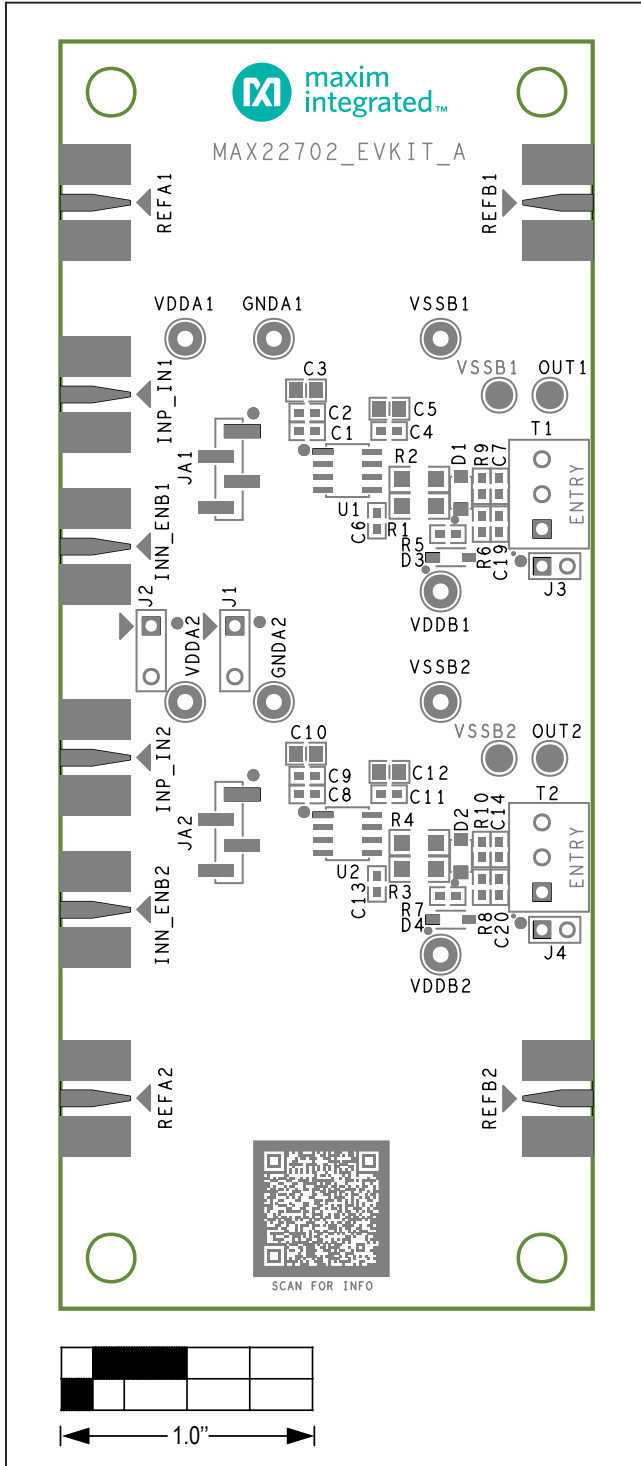

MAX22702 EV Kit PCB Layout—Top Silkscreen

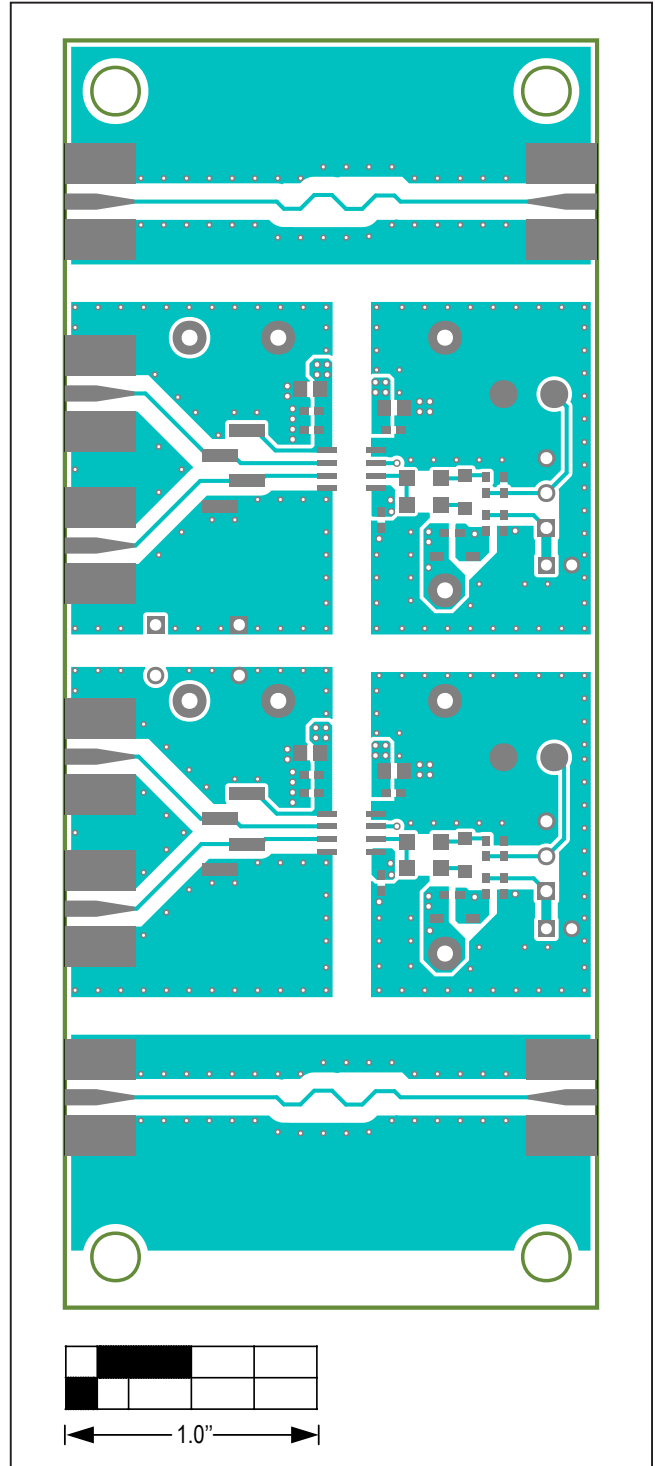

MAX22702 EV Kit PCB Layout—Top View

MAX22702 EV Kit PCB Layout Diagrams (continued)

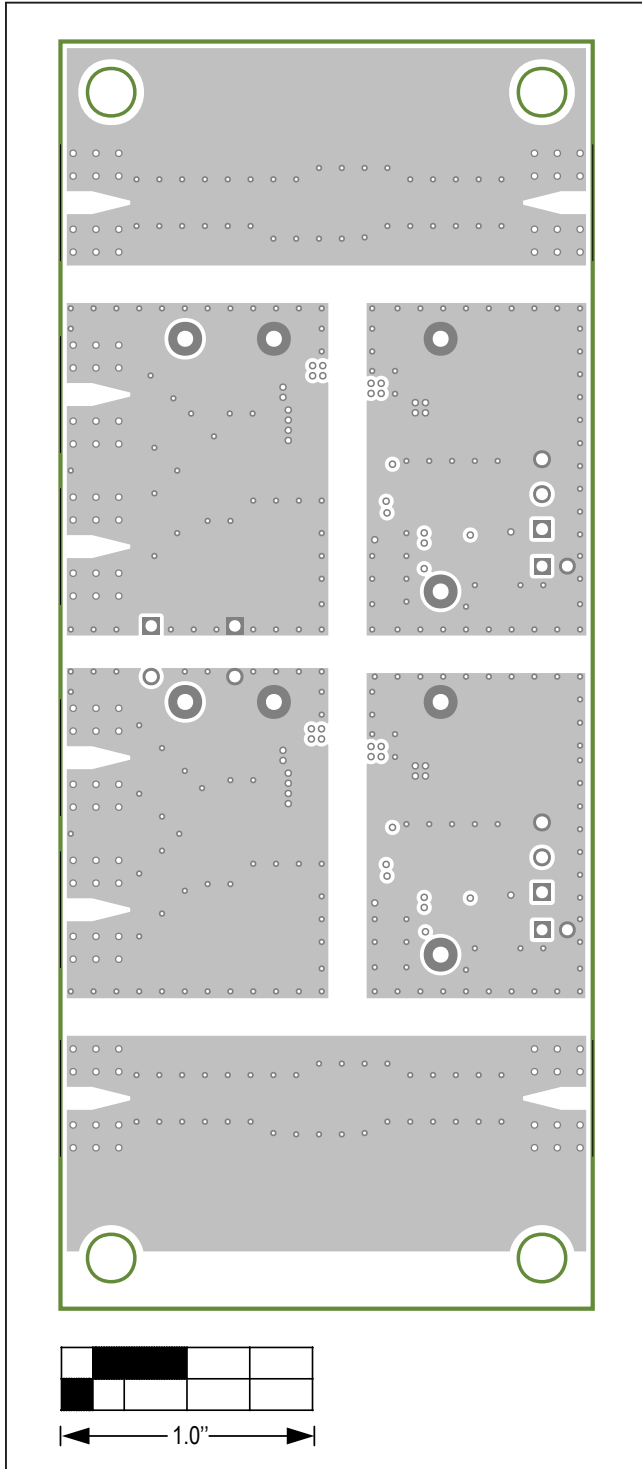

MAX22702 EV Kit PCB Layout—L2 GND

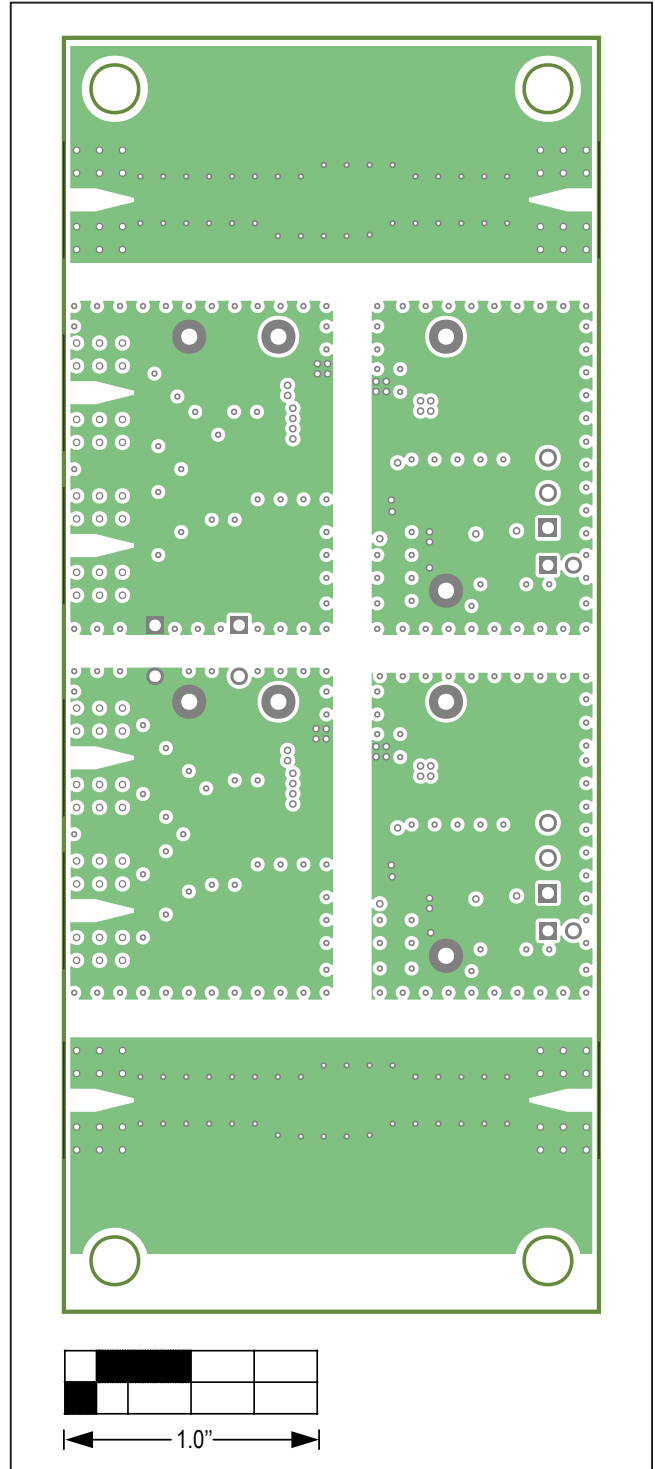

MAX22702 EV Kit PCB Layout—L3 PWR



MAX22702 EV Kit PCB Layout Diagrams (continued)

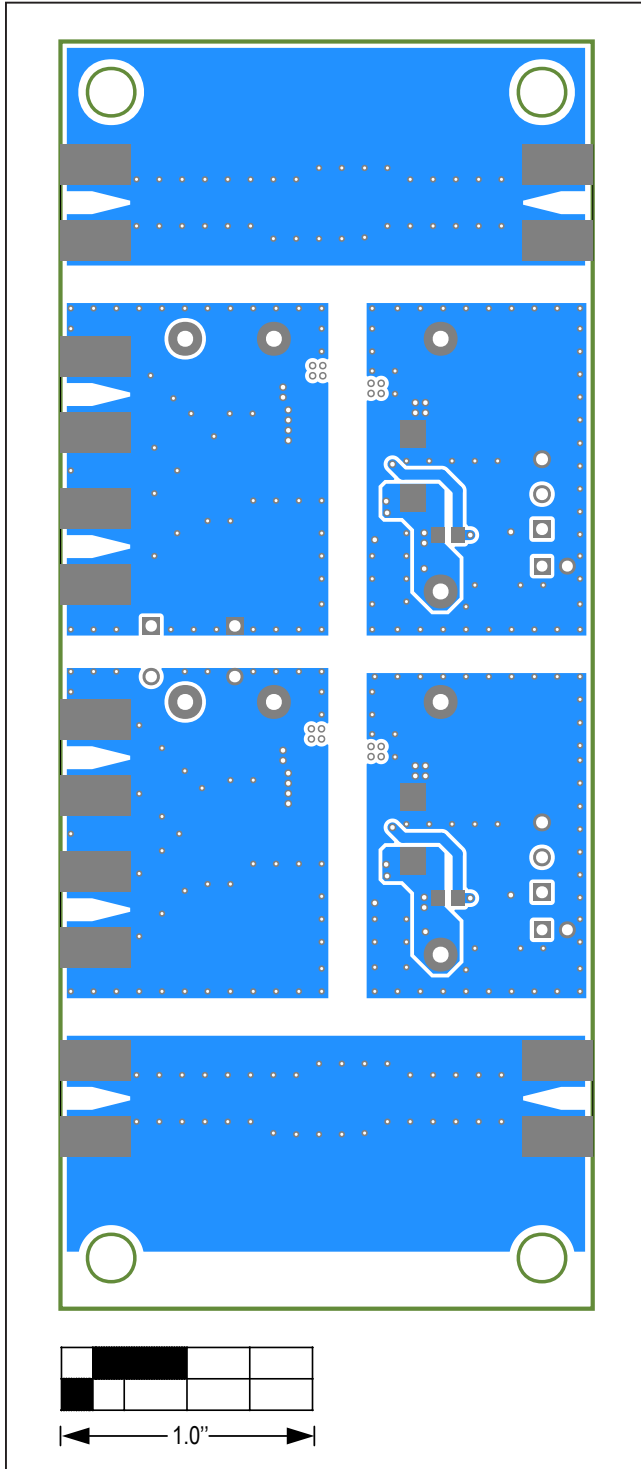

MAX22702 EV Kit—Bottom View

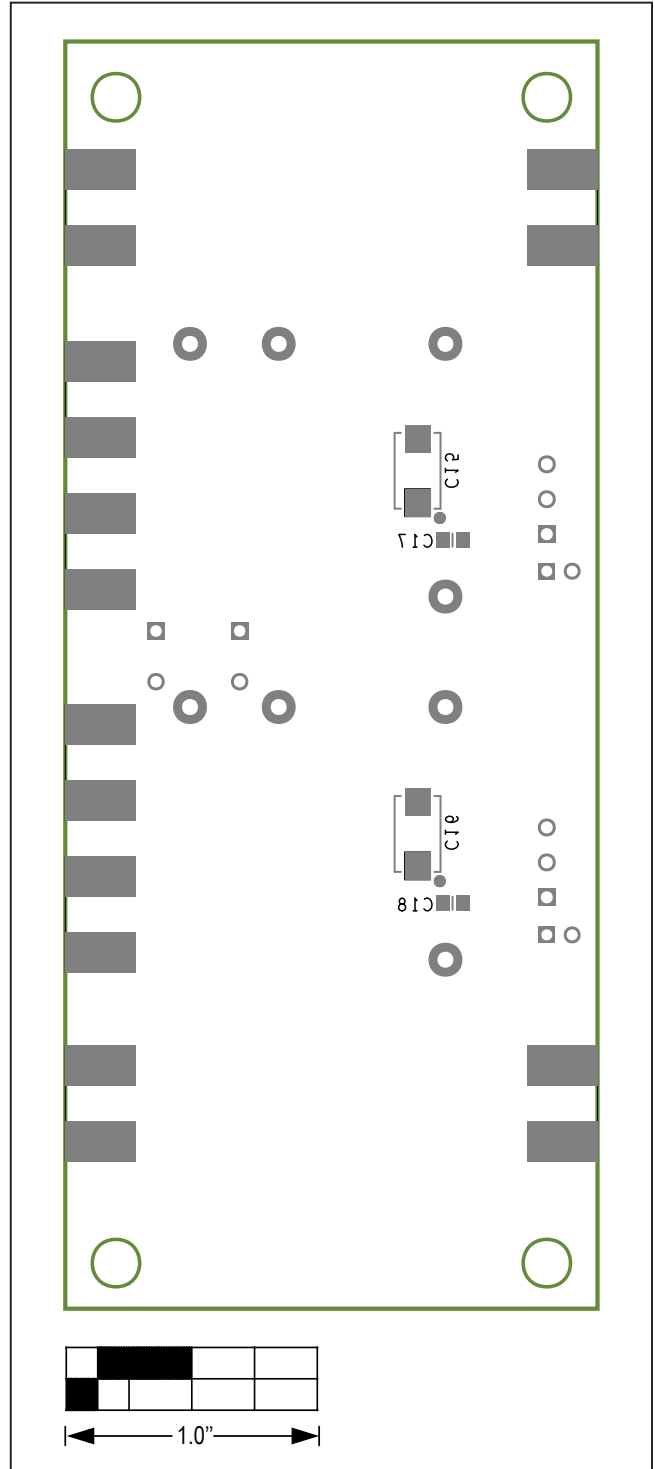

MAX22702 EV Kit PCB Layout—Bottom Silkscreen

MAX22700–MAX22702  
Evaluation Kits

Evaluates: MAX22700D–MAX22702D  
MAX22700E–MAX22702E

## Revision History

REVISION NUMBER	REVISION DATE	DESCRIPTION	PAGES CHANGED
0	10/19	Initial release	—
1	3/20	Removed future product designation from MAX22702EVKIT# in the <i>Ordering Information</i> table	7

For pricing, delivery, and ordering information, please visit Maxim Integrated's online storefront at <https://www.maximintegrated.com/en/storefront/storefront.html>.

*Maxim Integrated cannot assume responsibility for use of any circuitry other than circuitry entirely embodied in a Maxim Integrated product. No circuit patent licenses are implied. Maxim Integrated reserves the right to change the circuitry and specifications without notice at any time.*

# Mouser Electronics

Authorized Distributor

Click to View Pricing, Inventory, Delivery & Lifecycle Information:

[Maxim Integrated:](#)

[MAX22701EVKIT#](#)