

MAX17524EVKITE# Evaluation Kit

Evaluates: MAX17524 Dual-Output Voltage 3.3V and 5V Application

General Description

The MAX17524EVKITE# (EV kit) provides a proven design to evaluate the MAX17524 high-efficiency, high-voltage, synchronous step-down dual DC-DC converter. The EV kit is preset to generate 3.3V and 5V output voltages, at load currents up to 3A per converter and features a 450kHz switching frequency for optimum efficiency and component size. The EV kit features adjustable input undervoltage lockout, adjustable soft-start, open-drain $\overline{\text{RESET}}$ signal, and external clock synchronization. The EV kit also provides a good layout example that is optimized for conducted, radiated EMI and thermal performance. For more details about the IC benefits and features, refer to MAX17524 IC data sheet.

Features

- Operates from a 6.5V to 60V Input Supply
- Dual Output Voltage: 3.3V and 5V
- Up to 3A Output Current per Converter
- 450kHz Switching Frequency
- Enable/UVLO Input, Resistor-Programmable UVLO Threshold
- MODE/SYNC Pin to Select Among PWM, PFM, or DCM Modes
- Open-Drain $\overline{\text{RESET}}$ Output
- External Clock Synchronization
- Overcurrent and Overtemperature Protection
- Proven PCB Layout
- Fully Assembled and Tested
- Complies with CISPR22(EN55022) Class B Conducted and Radiated Emissions

Ordering Information appears at end of data sheet.

Quick Start

Recommended Equipment

- MAX17524EVKITE#
- 6.5V to 60V, 5A DC-input power supply
- Two loads capable of sinking 3A
- Four digital voltmeters (DVM)

Equipment Setup and Test Procedure

The EV kit is fully assembled and tested. Follow the steps below to verify the board operation.

Caution: Do not turn on power supply until all connections are completed.

- 1) Set the power supply at a voltage between 6.5V and 60V. Disable the power supply.
- 2) Connect the positive terminal of the power supply to the VIN1 PCB pad and the negative terminal to the nearest PGND PCB pad. Connect the positive terminal of the 3A load to the VOUT1 PCB pad and the negative terminal to the nearest PGND PCB pad. Connect the positive terminal of the other 3A load to the VOUT2 PCB pad and the negative terminal to the nearest PGND PCB pad.
- 3) Connect the DVMs across the VOUT1 PCB pad and the nearest PGND PCB pad, and across the VOUT2 PCB pad and the nearest PGND PCB pad.
- 4) Verify that shunts are installed across pins 1-2 on jumper JU4 and pins 1-2 on JU5 (see [Table 1](#) and [Table 2](#)).
- 5) Select the shunt position on jumper JU1 and JU2 according to the intended mode of operation (see [Table 3](#) and [Table 4](#)).
- 6) Verify that the shunt is connected across pins 1-2 on jumper JU3 (see [Table 6](#) for details).
- 7) Turn on the DC power supply.
- 8) Enable the loads.
- 9) Verify that the DVMs display 3.3V and 5V.
- 10) Connect two DVMs across the $\overline{\text{RESET}}_1$ pad and SGND, and $\overline{\text{RESET}}_2$ pad and SGND. Verify that the DVMs display 5V.
- 11) Reduce the input voltage to 5V, which is below the EN/UVLO falling threshold.
- 12) Verify that the DVMs across the VOUT1 pad and nearest PGND, and VOUT2 pad and nearest PGND display 0V.

MAX17524EVKITE# Evaluation Kit

Evaluates: MAX17524 Dual-Output Voltage 3.3V and 5V Application

- 13) Verify that the DVMS across the $\overline{\text{RESET1}}$ pad and nearest SGND, and $\overline{\text{RESET2}}$ pad and nearest SGND display 0V.
- 14) Disable the input.

Detailed Description

The MAX17524EVKITE# provides a proven design to evaluate the MAX17524 high-efficiency, high-voltage, synchronous step-down dual DC-DC converter. The EV kit generates a fixed 3.3V and 5V, at load currents up to 3A per channel, from a 6.5V to 60V input supply. The EV kit features a 450kHz fixed switching frequency for optimum efficiency and component size.

This EV kit includes an EN/UVLO PCB pad and JU4, JU5 to enable the two outputs at a desired input voltage. The MODE/SYNC1 PCB pad and JU1, and MODE/SYNC2 PCB pad and JU2 allow an external clock to synchronize the respective channels. The EV kit features individual mode-of-operation selector pins, adjustable input under-voltage lockout (EN/UVLO) pins, adjustable soft-start pins, and open-drain RESET signals for each output channel.

Soft-Start Input (SS)

The EV kit offers an adjustable soft-start operation for each output to reduce inrush current. Capacitors connected from the SS pins to SGND (C_{SS}) program the soft-start time for the corresponding output voltages. The selected output capacitance (C_{SEL}) and the output voltage (V_{OUT}) determine the minimum required soft-start capacitor as follows:

$$C_{SS} \geq 28 \times 10^{-6} \times C_{SEL} \times V_{OUT}$$

The soft-start time (t_{SS}) is related to the capacitor connected at SS (C_{SS}) by the following equation:

$$t_{SS} = \frac{C_{SS}}{(5.55 \times 10^{-6})}$$

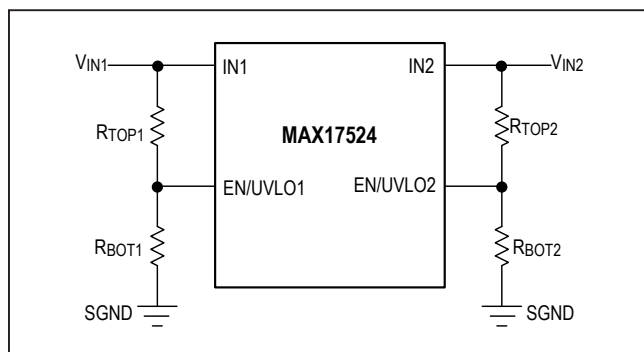

Figure 1. Setting the Input Undervoltage Lockout

For example, to program a 1ms soft-start time on one channel, a 5.6nF capacitor should be connected from the corresponding SS pin to SGND.

Enable/Undervoltage-Lockout (EN/UVLO1, EN/UVLO2) Programming

The MAX17524 offers an enable and adjustable input undervoltage-lockout level for each converter. In this EV kit leave EN/UVLO jumpers, JU4 and JU5 (for the converter 1 and converter 2, respectively) in the open position for the normal operation of the converters. When JU4 and JU5 are left open, the MAX17524 converters are enabled when the input voltage rises above 6.5V. To disable converter 1 and converter 2, install a jumper across pins 2-3 on JU4 and JU5, appropriately. See [Table 1](#) and [Table 2](#) for jumper settings. The EN/UVLO1 and EN/UVLO2 PCB pads on the EV kit support external enable/disable control of the converters. Leave JU4 and JU5 open when external enable/disable control is desired. Set the voltage at which the converter turns on with a resistive voltage-divider connected from the respective input (VIN1 and VIN2) to SGND. Connect the center node of the divider to the relevant EN/UVLO pins as shown in [Figure 1](#).

Choose R_{TOP} to be 3.32M Ω max, and then calculate R_{BOT} as follows:

$$R_{BOT} = \frac{R_{TOP} \times 1.216}{(V_{INU} - 1.216)}$$

where

V_{INU} is the voltage at which the converter is required to turn on

R_{TOP} and R_{BOT} are in k Ω

For more details about setting the undervoltage lockout level, refer to the MAX17524 data sheet.

Table 1. Converter 1 (EN/UVLO1) Jumper (JU4) Settings

SHUNT POSITION	EN/UVLO1 PIN	MAX17524 CONVERTER 1
1-2*	Connected to IN1	Enabled
Not installed	Connected to the center node of resistor-divider R1 and R2	Enabled, UVLO level set through the R1 and R2 resistors
2-3	Connected to SGND	Disabled

*Default position

MAX17524EVKITE# Evaluation Kit

Evaluates: MAX17524 Dual-Output
Voltage 3.3V and 5V Application

Mode Selection (MODE/SYNC1, MODE/SYNC2)

The EV Kit provide jumpers (JU1 and JU2, for the converter 1 and converter 2, respectively) that allow the MAX17524 converters to operate in PWM, PFM and DCM modes. Refer to MAX17524 datasheet for more details on the modes of operation. [Table 3](#) and [Table 4](#) shows the Mode Selection (JU1 and JU2) settings that can be used to configure the desired mode of operation for each converter.

External Clock Synchronization (MODE/SYNC1, MODE/SYNC2)

The EV Kit provides MODE/SYNC1 and MODE/SYNC2 PCB pads, to individually synchronize the MAX17524 converters to an optional external clock. Leave Jumpers (JU1 and JU2) open when external clock signals are applied. In the presence of a valid external clock for synchronization, the MAX17524 converters operate in PWM mode only. For more details about external clock synchronization, refer to the MAX17524 data sheet.

Table 2. Converter 2 (EN/UVLO2) Jumper (JU5) Settings

SHUNT POSITION	EN/UVLO2 PIN	MAX17524 CONVERTER 2
1-2*	Connected to IN2	Enabled
Not installed	Connected to the center node of resistor-divider R3 and R4	Enabled, UVLO level set through the R3 and R4 resistors
2-3	Connected to SGND	Disabled

*Default position

Table 3. Mode Selection Jumper (JU1) Settings

SHUNT POSITION	MODE/SYNC1 PIN	MAX17524 CONVERTER 1 MODE
Not installed	Unconnected	PFM mode of operation
1-2*	Connected to SGND	PWM mode of operation
2-3	Connected to VCC1	DCM mode of operation

*Default position

Active-Low, Open-Drain Reset Output (RESET1 and RESET2)

The EV kit provides $\overline{\text{RESET1}}$ and $\overline{\text{RESET2}}$ PCB pads to monitor the status of the converters. $\overline{\text{RESET1}}$ and $\overline{\text{RESET2}}$ goes high respectively, when VOUT1 and VOUT2 rise above 95% (typ) of their nominal regulated output voltage. $\overline{\text{RESET1}}$ and $\overline{\text{RESET2}}$ goes low when VOUT1 and VOUT2 falls below 92% (typ) of their nominal regulated voltage.

Converter 2 Input Supply (IN2) Connection

By default, the converter 2 input supply is derived from the converter 1 input supply, through a jumper resistor connection RIN1. The MAX17524EVKITE# PCB layout has also the provision at VIN2 PCB pad, to power up the converter 2 through a second supply by removing RIN1 and placing a jumper resistor on RIN2. [Table 5](#) shows the converter 2 input supply connection settings.

Table 4. Mode Selection Jumper (JU2) Settings

SHUNT POSITION	MODE/SYNC2 PIN	MAX17524 CONVERTER 2 MODE
Not installed	Unconnected	PFM mode of operation
1-2*	Connected to SGND	PWM mode of operation
2-3	Connected to VCC2	DCM mode of operation

*Default position

Table 5. Converter 2 Input (IN2) Connection Settings

RIN1 CONNECTION	RIN2 CONNECTION	CONVERTER 2 INPUT (IN2) CONNECTION
Jumper Resistor*	Open	Derived from IN1
Open	Jumper resistor	Through a supply connected at VIN2 PCB Pad

*Default position

Converter 2 EXTVCC Pin Connection

The EV kit provides a jumper connection to the pin EXTVCC2 from the output voltage node of the converter 1 (VOUT1) for the improved efficiency. The EXTVCC2 pin can be grounded to disable its functionality. [Table 6](#) shows the EXTVCC2 connection settings. For more details about EXTVCC2, refer to the MAX17524 data sheet.

Table 6. EXTVCC2 Connection Jumper (JU3) Settings

SHUNT POSITION	EXTVCC2 PIN	SETTING
Not installed	Unconnected	Not recommended
1-2*	Connected to VOUT1	Improved efficiency
2-3	Connected to SGND	EXTVCC functionality disabled

*Default position

Hot Plug-In and Long Input Cables

The MAX17524EVKITE# PCB layout provides an optional electrolytic capacitor (C9 = 47 μ F/80V). In the default EV kit configuration (RIN2 in an open position), this capacitor limits the peak voltage at the inputs of the MAX17524 converters when the DC input source is hot-plugged to the EV kit input terminals with long input cables. The equivalent series resistance (ESR) of the electrolytic capacitor dampens the oscillations caused by interaction of the inductance of the long input cables, and the ceramic capacitors at the buck converter input.

Electromagnetic Interference (EMI)

Compliance to conducted emissions (CE) standards requires an EMI filter at the input of a switching power converter. The EMI filter attenuates high-frequency currents drawn by the switching power converter, and limits the noise injected back into the input power source.

The MAX17524EVKITE# PCB has designated footprints on the EV kit for placement of EMI filter components. Use of these filter components results in lower conducted EMI, below CISPR22 Class B limits. Cut open the trace at L3 before installing EMI filter components. The MAX17524EVKITE# PCB layout is also designed to limit radiated emissions from switching nodes of the power converters, resulting in radiated emissions below CISPR22 Class B limits.

MAX17524EVKITE# Performance Report

($V_{IN1} = 24V$, $R_{IN1} = 0\Omega$, $R_{IN2} = \text{open}$, $f_{SW} = 450kHz$, $T_A = 25^\circ C$, unless otherwise noted.)

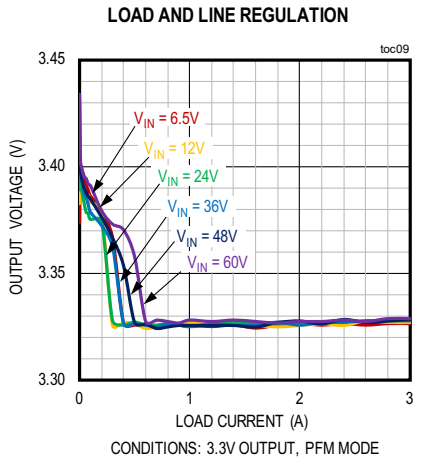
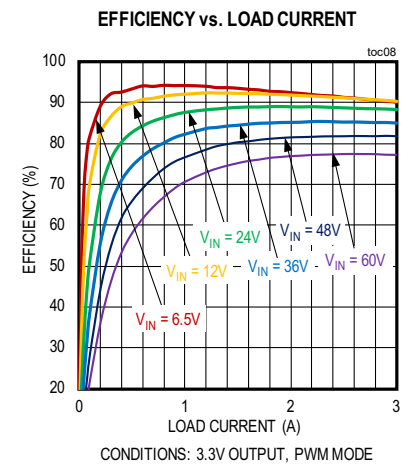
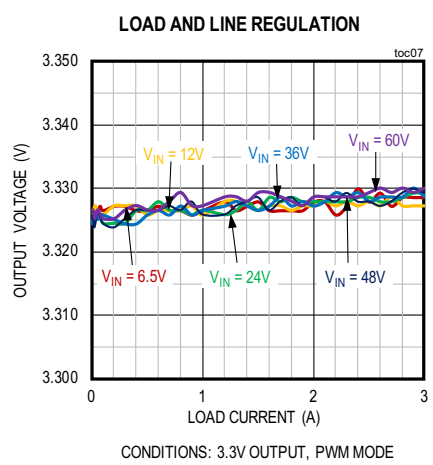
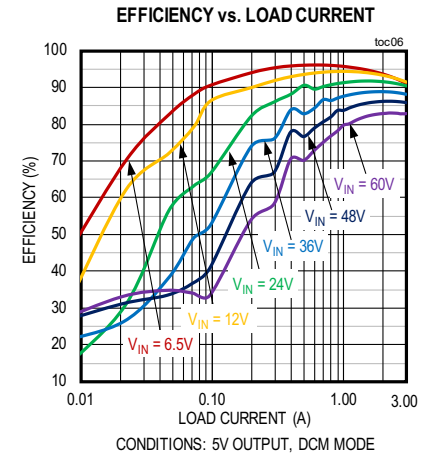
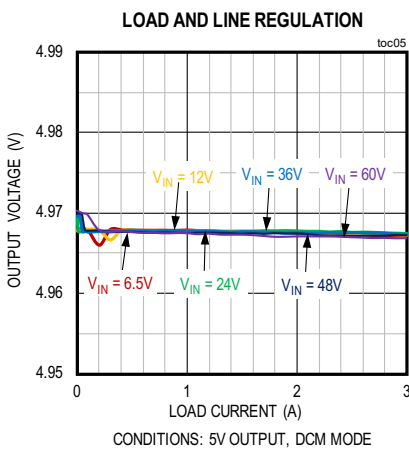
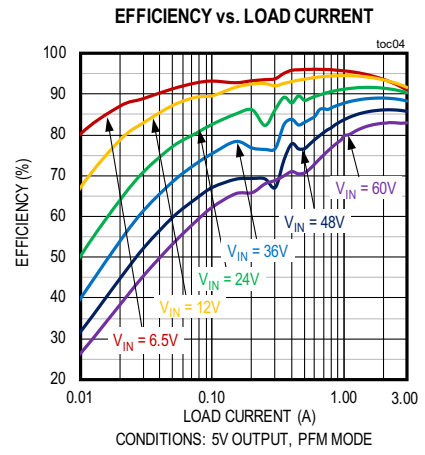
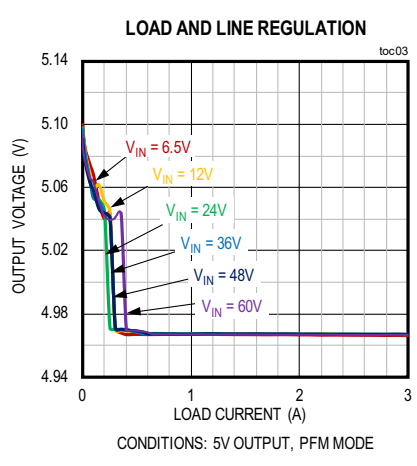
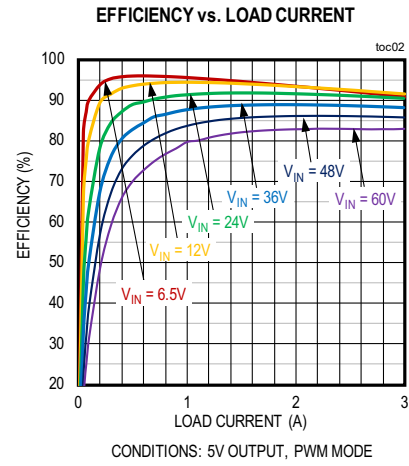
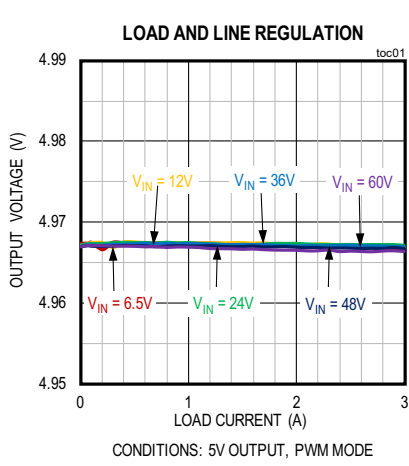

MAX17524EVKITE# Evaluation Kit

Evaluates: MAX17524 Dual-Output Voltage 3.3V and 5V Application

MAX17524EVKITE# Performance Report (continued)

($V_{IN1} = 24V$, $R_{IN1} = 0\Omega$, $R_{IN2} = \text{open}$, $f_{SW} = 450kHz$, $T_A = 25^\circ C$, unless otherwise noted.)

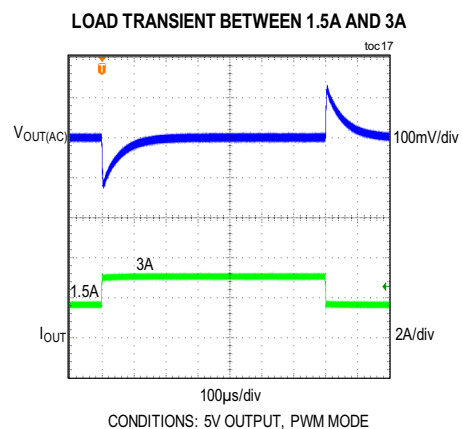
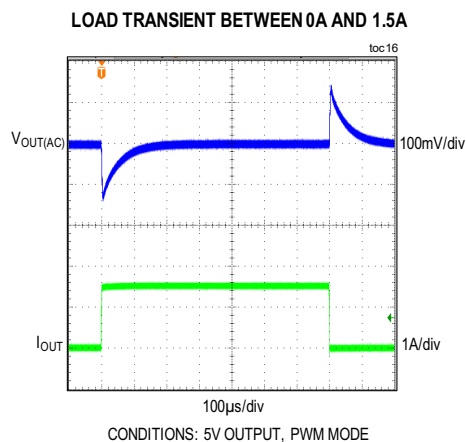
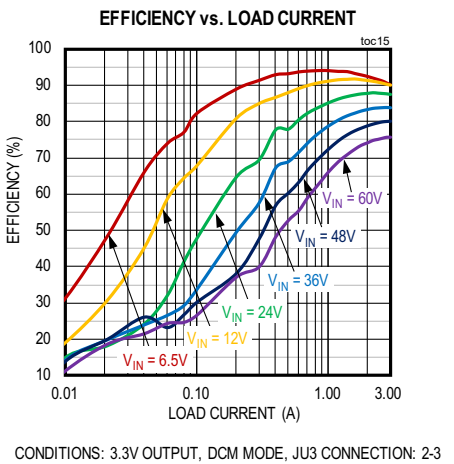
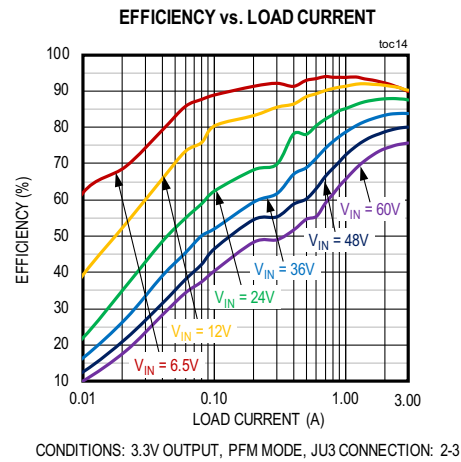
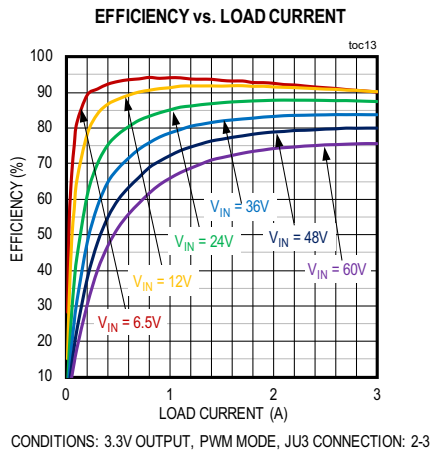
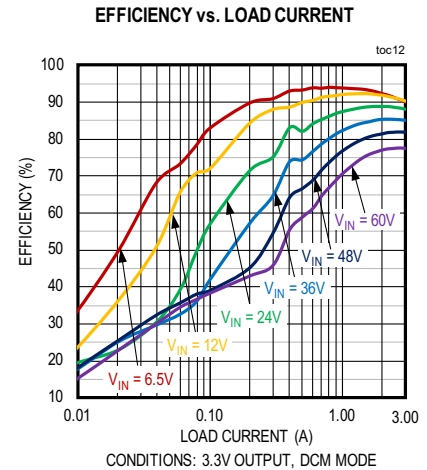
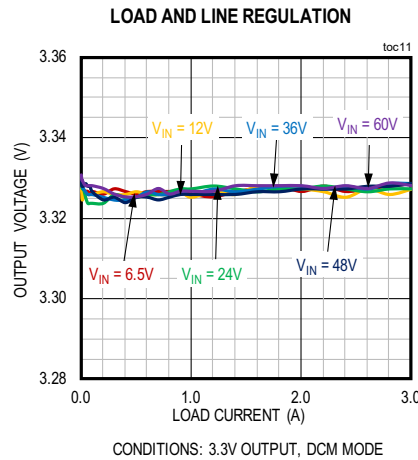
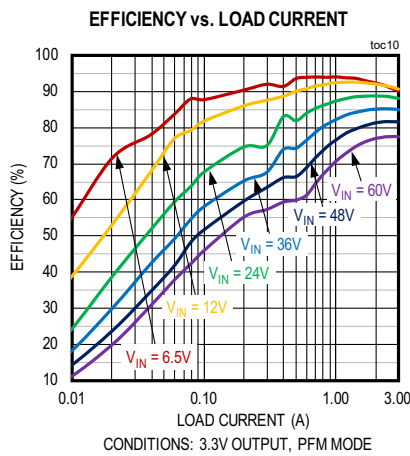

MAX17524EVKITE# Performance Report (continued)

($V_{IN1} = 24V$, $R_{IN1} = 0\Omega$, $R_{IN2} = \text{open}$, $f_{SW} = 450kHz$, $T_A = 25^\circ C$, unless otherwise noted.)

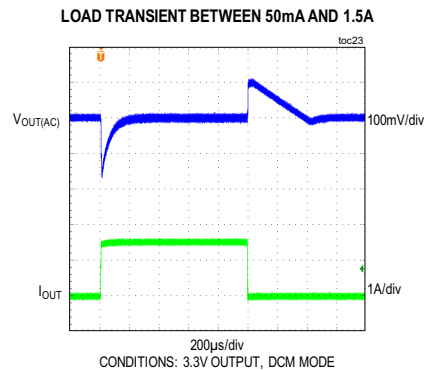
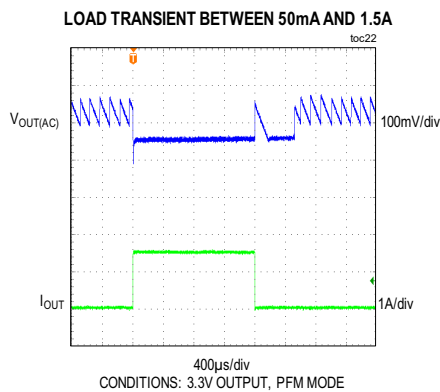
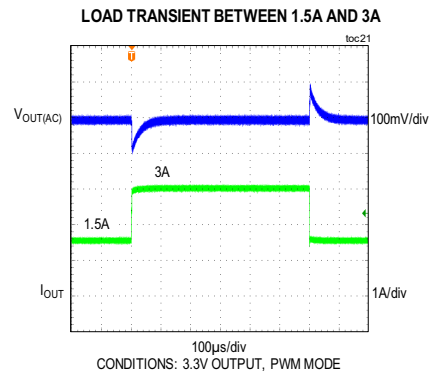
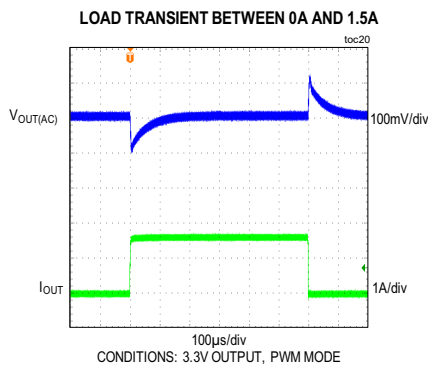
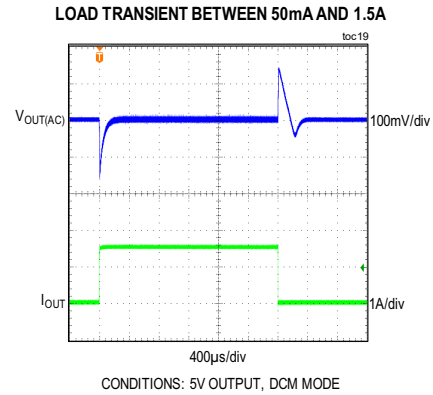
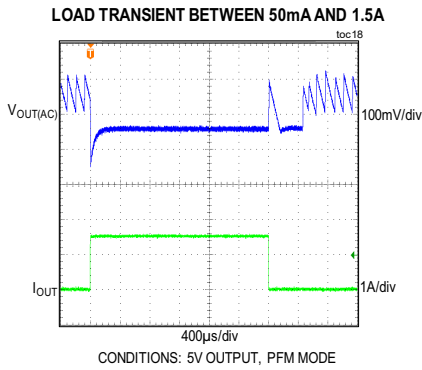

MAX17524EVKITE# Performance Report (continued)

($V_{IN1} = 24V$, $R_{IN1} = 0\Omega$, $R_{IN2} = \text{open}$, $f_{SW} = 450kHz$, $T_A = 25^\circ C$, unless otherwise noted.)

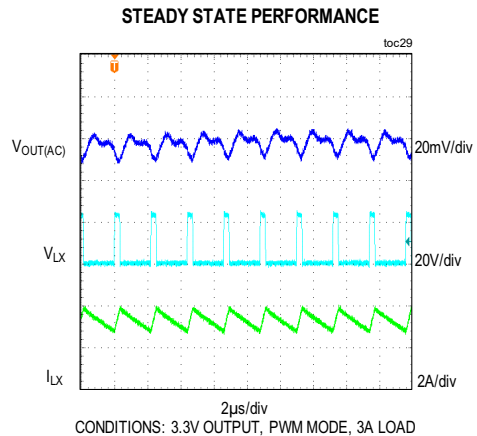
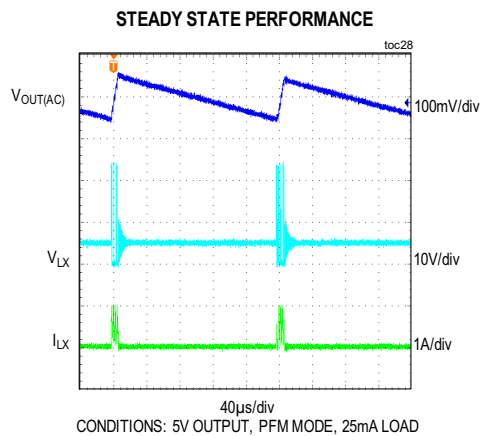
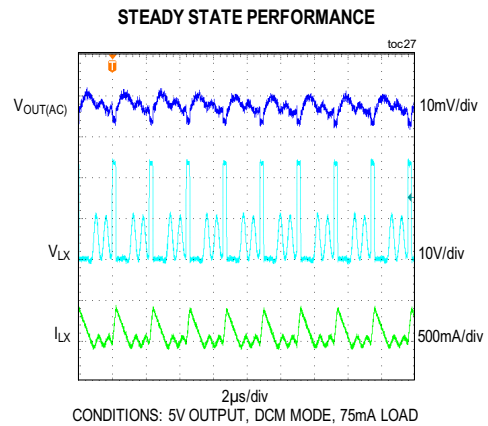
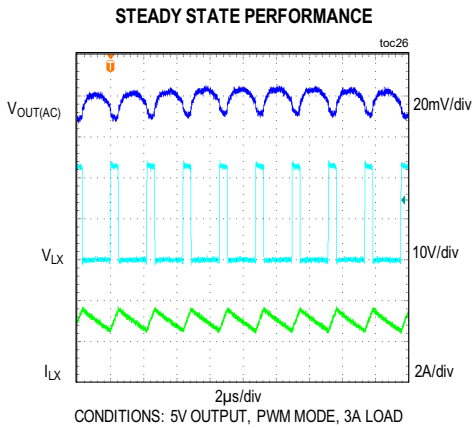
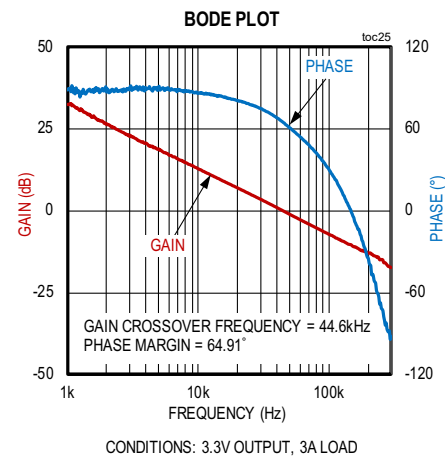
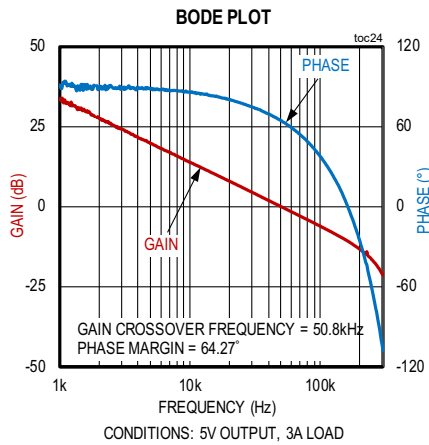

MAX17524EVKITE# Performance Report (continued)

($V_{IN1} = 24V$, $R_{IN1} = 0\Omega$, $R_{IN2} = \text{open}$, $f_{SW} = 450kHz$, $T_A = 25^\circ C$, unless otherwise noted.)

STEADY STATE PERFORMANCE

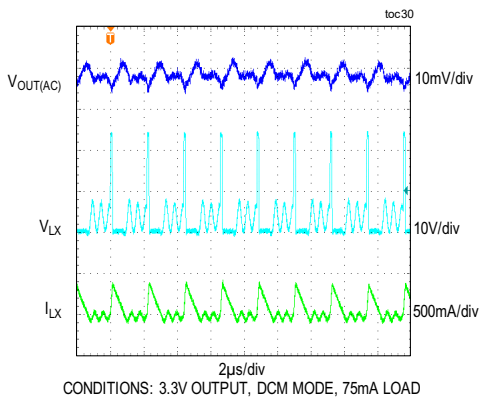

STEADY STATE PERFORMANCE

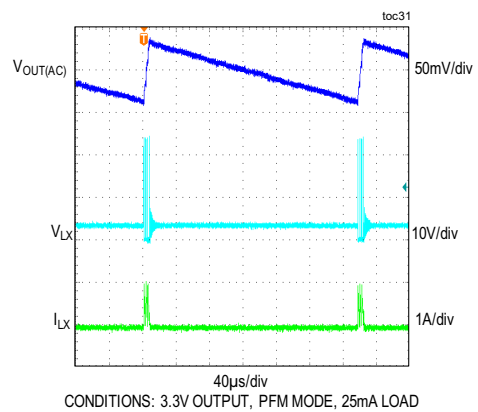

SOFT-START/SHUTDOWN THROUGH EN/UVLO

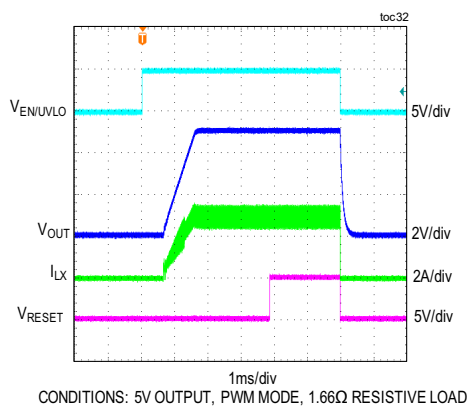

SOFT-START WITH PREBIAS VOLTAGE OF 2.5V

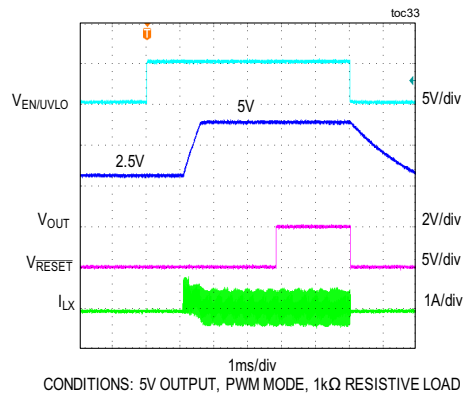

SOFT-START/SHUTDOWN THROUGH EN/UVLO

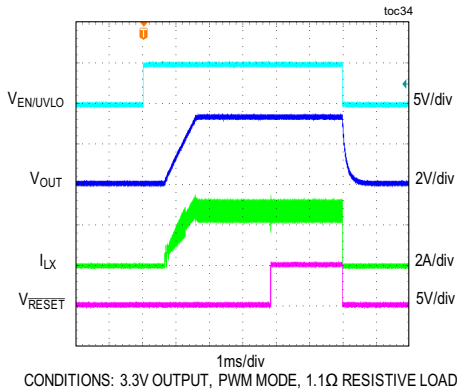

SOFT-START WITH PREBIAS VOLTAGE OF 1.65V

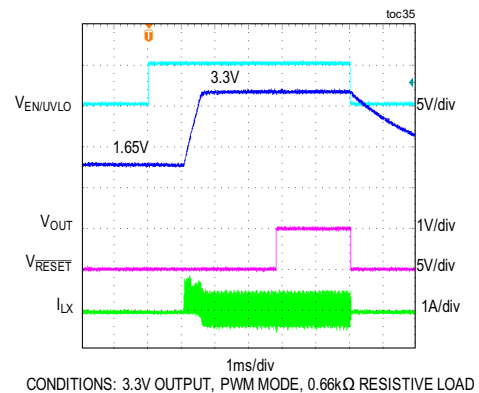

MAX17524EVKITE# Performance Report (continued)

($V_{IN1} = 24V$, $R_{IN1} = 0\Omega$, $R_{IN2} = \text{open}$, $f_{SW} = 450\text{kHz}$, $T_A = 25^\circ\text{C}$, unless otherwise noted.)

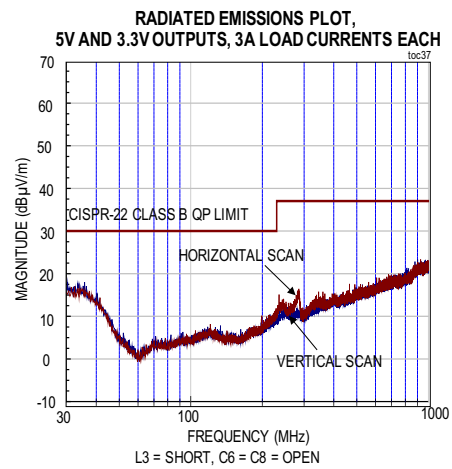
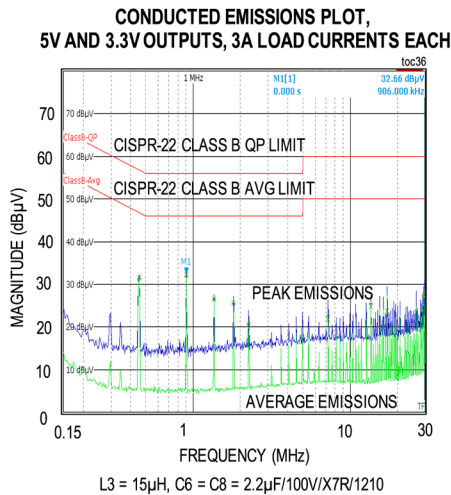

Ordering Information

PART	TYPE
MAX17524EVKITE#	EV Kit

#Denotes RoHS compliance.

Component Suppliers

SUPPLIER	WEBSITE
Coilcraft, Inc.	www.coilcraft.com
Murata Americas	www.murataamericas.com
Panasonic Corp.	www.panasonic.com
Vishay	www.vishay.com
TDK	www.tdk.com
Taiyo Yuden	www.yuden.co.jp/eu/

Note: Indicate that you are using the MAX17524 when contacting these component suppliers.

MAX17524EVKITE#
Evaluation Kit

Evaluates: MAX17524 Dual-Output
Voltage 3.3V and 5V Application

MAX17524EVKITE# Bill of Materials

S.No	DESIGNATOR	DESCRIPTION	QUANTITY	MANUFACTURER PART NUMBER
1	C1	220pF, 5%, 100V, COG, Ceramic capacitor (0603)	1	TDK C1608COG2A221J080AA
2	C2, C11, C27	0.1µF, 10%, 100V, X7R, Ceramic capacitor (0603)	3	TAIYO YUDEN HMK107B7104KA-T
3	C9	47µF, 20%, 80V, Electrolytic capacitor	1	PANASONIC EEE-FK1K470P
4	C10, C26	4.7µF, 10%, 100V, X7R, Ceramic capacitor (1206)	2	MURATA GRM31CZ72A475KE11
5	C14, C30, C31	47µF, 10%, 10V, X7R, Ceramic capacitor (1210)	3	MURATA GRM32ER71A476KE15
6	C15	22µF, 20%, 25V, X7R, Ceramic capacitor (1210)	1	MURATA GRM32ER71E226ME15
7	C19, C21, C35, C37	0.1µF, 10%, 16V, X7R, Ceramic capacitor (0402)	4	TAIYO YUDEN EMK105B7104KV-F
8	C23, C39	0.1µF, 10%, 50V, X7R, Ceramic capacitor (0402)	2	MURATA GRM155R71H104KE14
9	C24, C40	2.2µF, 10%, 10V, X7R, Ceramic capacitor (0603)	2	MURATA GRM188R71A225KE15
10	C25, C41	5600pF, 10%, 25V, X7R, Ceramic capacitor (0402)	2	MURATA GRM155R71E562KA01
11	L1	Inductor, 10µH, 7A (6mm X 6mm)	1	COILCRAFT XAL6060-103ME
12	L2	Inductor, 6.8µH, 9A (6mm X 6mm)	1	COILCRAFT XAL6060-682ME
13	Q1, Q2	MOSFET (80V, 30A) (3.3mm X 3.3mm)	2	VISHAY SILICONIX SIS468DN-T1-GE3
14	R1, R3	3.32MΩ, ±1%, 1/10W, Resistor (0603)	2	
15	R2, R4	768kΩ, ±1%, 1/10W, Resistor (0603)	2	
16	R5	140kΩ, ±1%, 1/10W, Resistor (0402)	1	
17	R6	30.9kΩ, ±1%, 1/16W, Resistor (0402)	1	
18	R7	100kΩ, ±1%, 1/16W, Resistor (0402)	1	
19	R8	37.4kΩ, ±1%, 1/16W, Resistor (0402)	1	
20	R9, R10, R16, R17	10kΩ, ±1%, 1/16W, Resistor (0402)	4	
21	R12, R13	0Ω, ±5%, 1/16W, Resistor (0402)	2	
22	R14, R15	4.7Ω, ±1%, 1/16W, Resistor (0402)	2	
23	RIN1	0Ω, ±5%, 1/2W, Resistor (0805)	1	
24	U1	Dual Buck Converter, MAX17524, 32 TQFN (5mm x 5mm)	1	MAXIM MAX17524ATJ+
25	JU1, JU2, JU3, JU4, JU5	3-pin header (36-pin header 0.1" centers)	5	SULLINS PEC03SAAN
26	L3	OPTIONAL: Inductor, 15µH, 2.2A (4mm x 4mm)	1	COILCRAFT XAL4040-153ME
27	C6, C8	OPTIONAL: 2.2µF, 10%, 100V, X7R, Ceramic capacitor (1210)	2	TAIYO YUDEN HMK325B7225KM-P
28	C3, C12, C16, C17, C22, C29, C32, C33, C38	OPEN: Capacitor (0402)	0	N/A
29	C4, C13, C18, C28, C34	OPEN: Capacitor (0603)	0	N/A
30	C5, C7, C20, C36	OPEN: Capacitor (1210)	0	N/A
31	R11	OPEN: Resistor (0402)	0	N/A
32	RIN2	OPEN: Resistor (0805)	0	N/A

DEFAULT JUMPER TABLE	
Jumper	Shunt Position
JU1, JU2, JU3, JU4, JU5	1-2 Short

MAX17524EVKITE# Evaluation Kit

Evaluates: MAX17524 Dual-Output
Voltage 3.3V and 5V Application

MAX17524EVKITE# Schematic

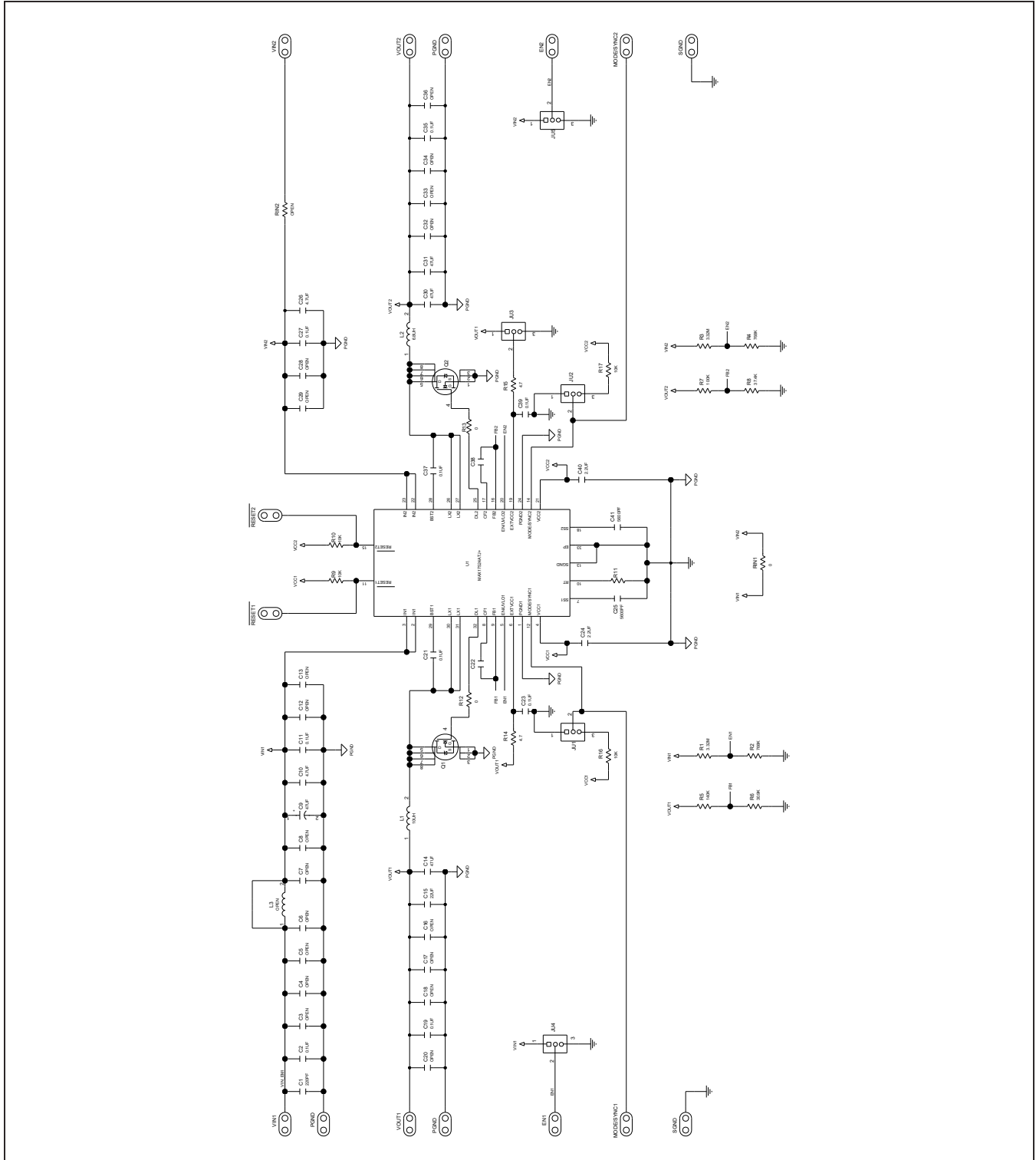

MAX17524EVKITE# Evaluation Kit

Evaluates: MAX17524 Dual-Output
Voltage 3.3V and 5V Application

MAX17524EVKITE# PCB Layout

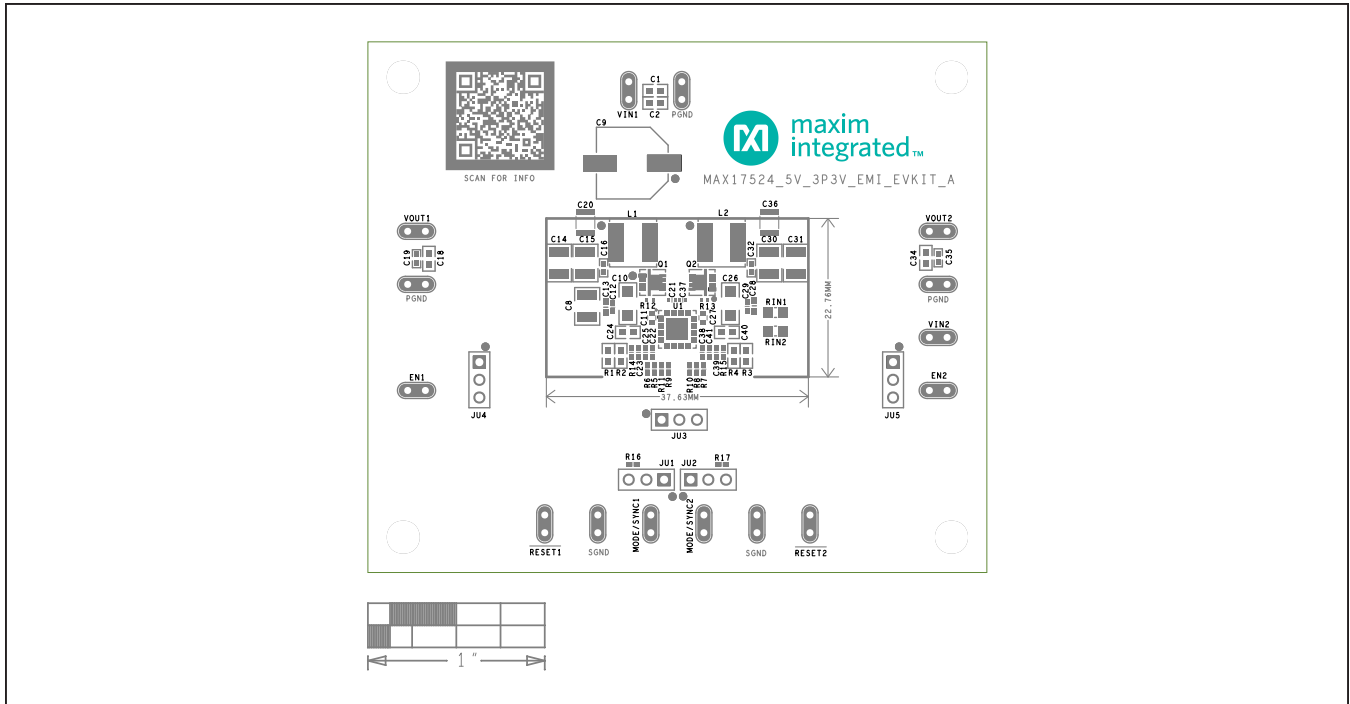

MAX17524EVKITE# PCB—Top Silkscreen

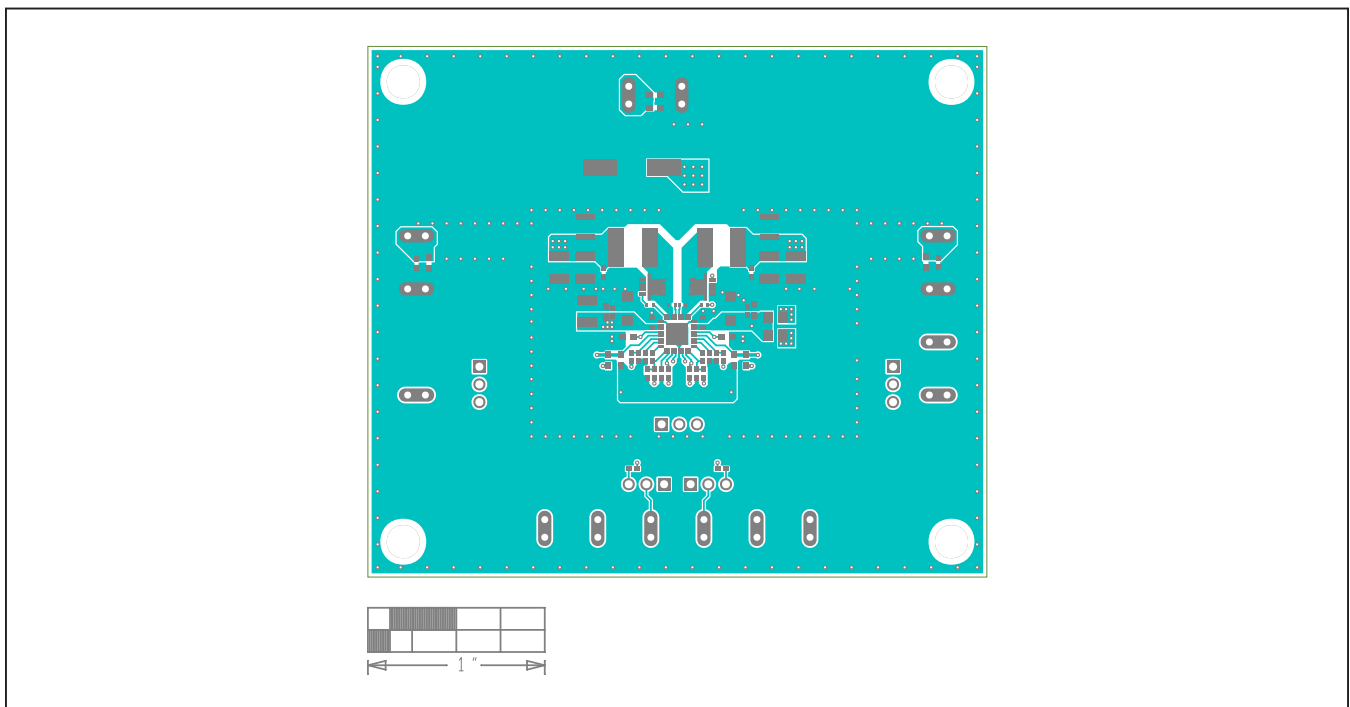

MAX17524EVKITE# PCB—Top Layer

MAX17524EVKITE#
Evaluation Kit

Evaluates: MAX17524 Dual-Output
Voltage 3.3V and 5V Application

MAX17524EVKITE# PCB Layout (continued)

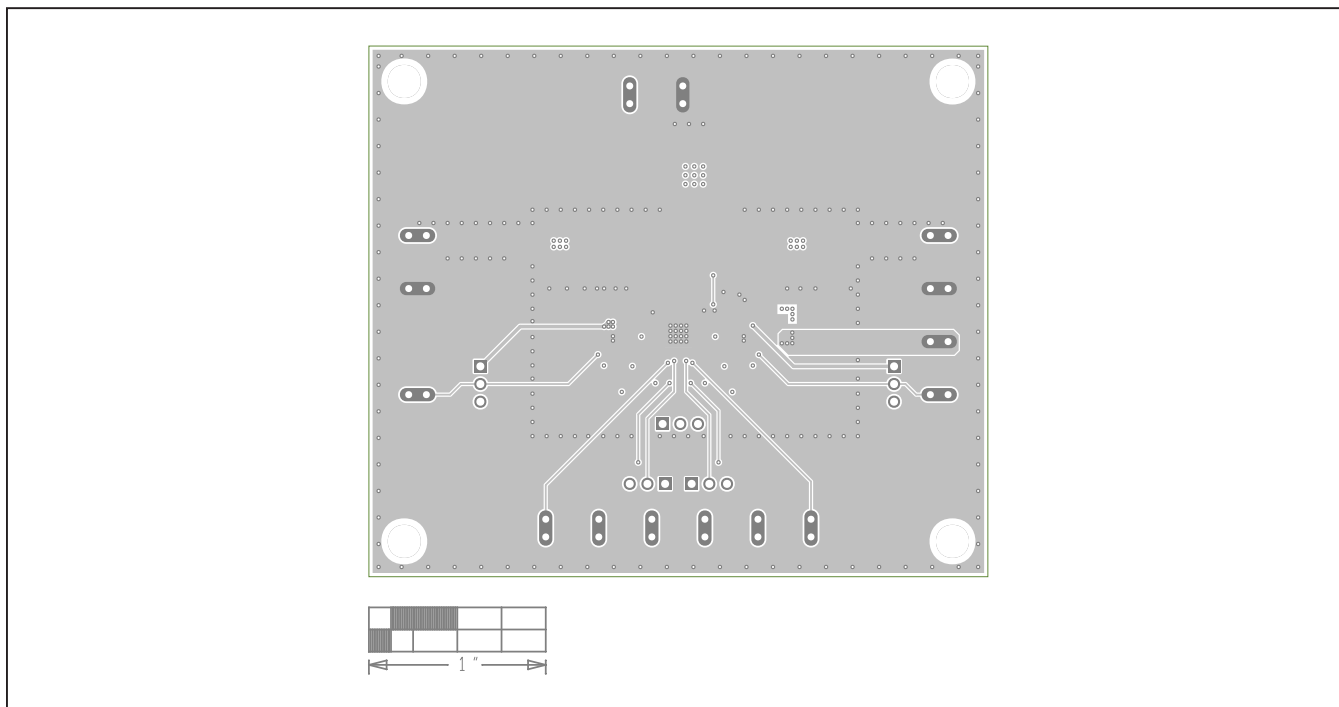

MAX17524EVKITE# PCB—Layer 2

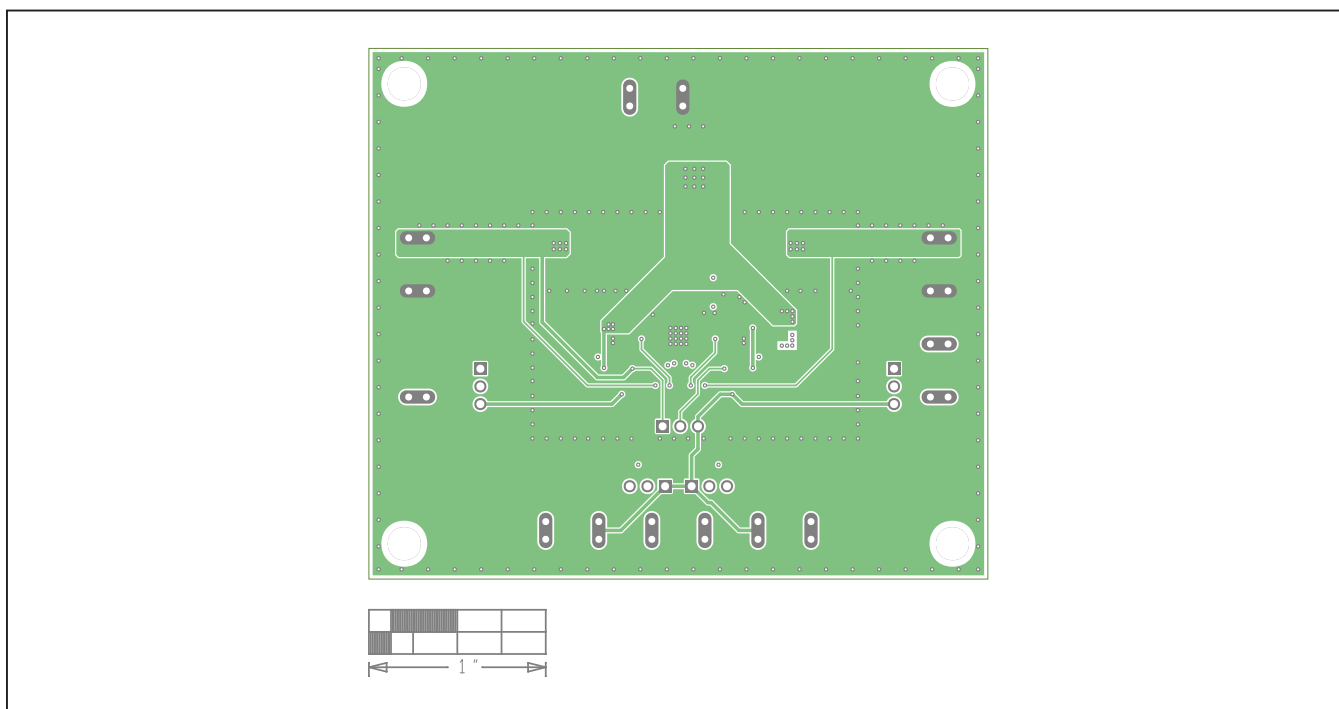

MAX17524EVKITE# PCB—Layer 3

MAX17524EVKITE#
Evaluation Kit

Evaluates: MAX17524 Dual-Output
Voltage 3.3V and 5V Application

MAX17524EVKITE# PCB Layout (continued)

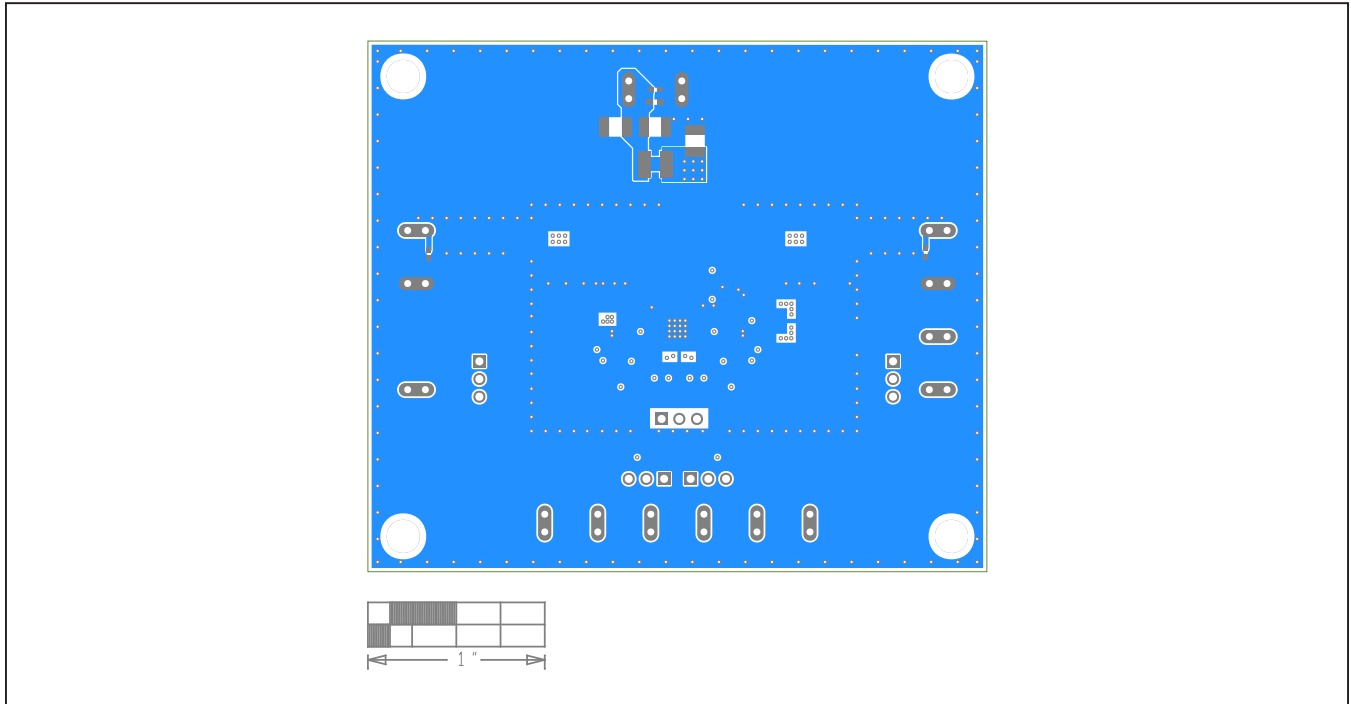

MAX17524EVKITE# PCB—Bottom Layer

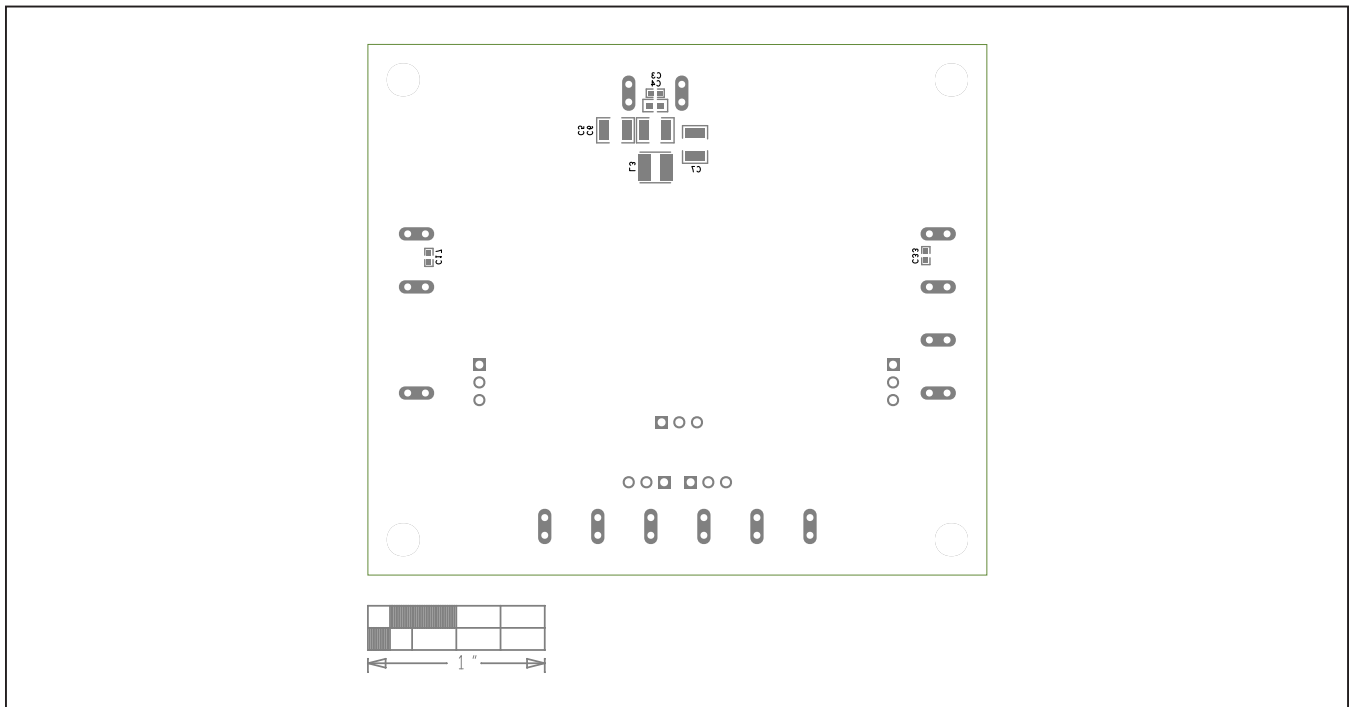

MAX17524EVKITE# PCB—Bottom Silkscreen

MAX17524EVKITE#
Evaluation Kit

Evaluates: MAX17524 Dual-Output
Voltage 3.3V and 5V Application

Revision History

REVISION NUMBER	REVISION DATE	DESCRIPTION	PAGES CHANGED
0	1/20	Initial release	—

For pricing, delivery, and ordering information, please visit Maxim Integrated's online storefront at <https://www.maximintegrated.com/en/storefront/storefront.html>.

Maxim Integrated cannot assume responsibility for use of any circuitry other than circuitry entirely embodied in a Maxim Integrated product. No circuit patent licenses are implied. Maxim Integrated reserves the right to change the circuitry and specifications without notice at any time.

Mouser Electronics

Authorized Distributor

Click to View Pricing, Inventory, Delivery & Lifecycle Information:

[Maxim Integrated:](#)

[MAX17524EVKITE#](#)