

PTRA093818NF

Thermally-Enhanced High Power RF LDMOS FET
415 W, 48 V, 925 – 960 MHz



Package Types: PG-HBSOF-6-2

Description

The PTRA093818NF is a 415-watt LDMOS FET intended for use in multi-standard cellular power amplifier applications in the 925 to 960 MHz frequency band. Features include input matching, high gain and thermally-enhanced package with earless flanges. Manufactured with an advanced LDMOS process, this device provides excellent thermal performance and superior reliability.

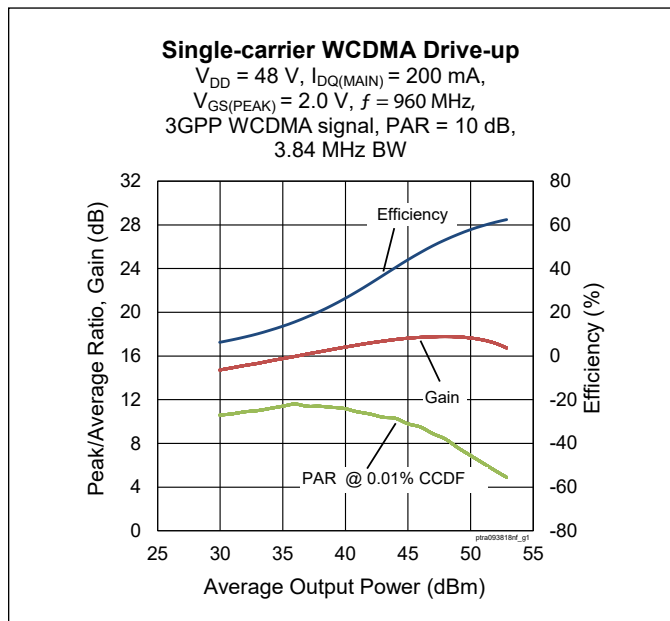

Features

- Broadband internal input matching
- Asymmetrical design
 - Main : $P_{1dB} = 165\text{ W Typ}$
 - Peak : $P_{1dB} = 250\text{ W Typ}$
- Typical Pulsed CW performance, 960 MHz, 48 V, Doherty configuration
 - Output power at $P_{3dB} = 375\text{ W}$
 - Efficiency = 55%
 - Gain = 18 dB
- Capable of handling 10:1 VSWR @ 48 V, 81.4 W CW output power
- Integrated ESD protection
- Human Body Model class 1C (per ANSI/ESDA/ JEDEC JS-001)
- Low thermal resistance
- Pb-free and RoHS compliant

RF Characteristics

Single-carrier WCDMA Specifications (tested in the Doherty production test fixture)

$V_{DD} = 48\text{ V}$, $I_{DQ} = 200\text{ mA}$, $V_{GS(PEAK)} = 2.0\text{ V}$, $P_{OUT} = 81.3\text{ W avg}$, $f = 960\text{ MHz}$, 3GPP signal, channel bandwidth = 3.84 MHz, peak/average = 10 dB @ 0.01% CCDF

Characteristic	Symbol	Min.	Typ.	Max.	Unit
Linear Gain	G_{ps}	16.5	17	—	dB
Drain Efficiency	η_D	49	52	—	%
Adjacent Channel Power Ratio	ACPR	—	-30	-28.5	dBc
Output PAR @ 0.01% CCDF	OPAR	7	7.7	—	dB

Note:

All published data at $T_{CASE} = 25^\circ\text{C}$ unless otherwise indicated

ESD: Electrostatic discharge sensitive device—observe handling precautions!



DC Characteristics (each side)

Characteristic	Symbol	Min.	Typ.	Max.	Unit	Conditions
Drain-Source Breakdown Voltage	$V_{BR(DSS)}$	105	—	—	V	$V_{GS} = 0\text{ V}, I_{DS} = 10\text{ mA}$
Drain Leakage Current	I_{DSS}	—	—	1	μA	$V_{DS} = 50\text{ V}, V_{GS} = 0\text{ V}$
		—	—	10		$V_{DS} = 105\text{ V}, V_{GS} = 0\text{ V}$
Gate Leakage Current	I_{GSS}	—	—	1		$V_{GS} = 10\text{ V}, V_{DS} = 0\text{ V}$
On-State Resistance (main)	$R_{DS(on)}$	—	0.12	—	Ω	$V_{GS} = 10\text{ V}, V_{DS} = 0.1\text{ V}$
On-State Resistance (peak)		—	0.08	—		
Operating Gate Voltage (main)	V_{GS}	3	3.5	4	V	$V_{DS} = 48\text{ V}, I_{DQ} = 0.9\text{ A}$
Operating Gate Voltage (peak)		—	2	—		$V_{DS} = 48\text{ V}, I_{DQ} = 0\text{ A}$

Maximum Ratings

Parameter	Symbol	Value	Unit
Drain-source Voltage	V_{DSS}	105	V
Gate-source Voltage	V_{GS}	-6 to +12	
Operating Voltage	V_{DD}	0 to +55	
Junction Temperature	T_J	225	$^{\circ}\text{C}$
Storage Temperature Range	T_{STG}	-65 to +150	

1. Operation above the maximum values listed here may cause permanent damage. Maximum ratings are absolute ratings; exceeding only one of these values may cause irreversible damage to the component. Exposure to absolute maximum rating conditions for extended periods may affect device reliability. For reliable continuous operation, the device should be operated within the operating voltage range (V_{DD}) specified above.

2. Parameters values can be affected by end application and product usage. Values may change over time.

Thermal Characteristics

Characteristics	Symbol	Value	Unit	Conditions
Thermal Resistance (Main)	$R_{\theta JC}$	0.57	$^{\circ}\text{C}/\text{W}$	$T_{CASE} = 70^{\circ}\text{C}, 81.3\text{ W CW}$

Moisture Sensitivity Level

Level	Test Signal	Package Temperature	Unit
3	IPC/JEDEC J-STD-020	260	$^{\circ}\text{C}$

Ordering Information

Type and Version	Order Code	Package and Description	Shipping
PTRA093818NF V1 R5	PTRA093818NF-V1-R5	PG-HBSOF-6-2	Tape & Reel, 500 pcs

Typical Performance (data taken in a production test fixture)

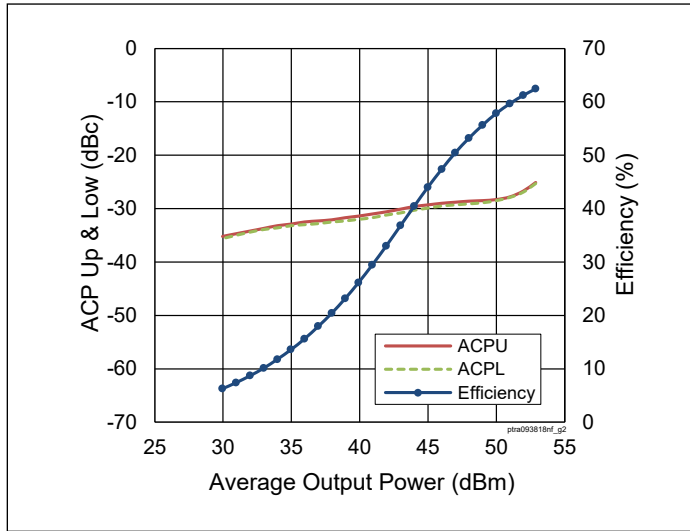

Figure 1. Single-carrier WCDMA Drive-up

$V_{DD} = 48\text{ V}$, $I_{DQ(MAIN)} = 200\text{ mA}$,
 $V_{GS(PEAK)} = 2.0\text{ V}$, $f = 960\text{ MHz}$,
 3GPP WCDMA signal, PAR = 10 dB,
 BW = 3.84 MHz

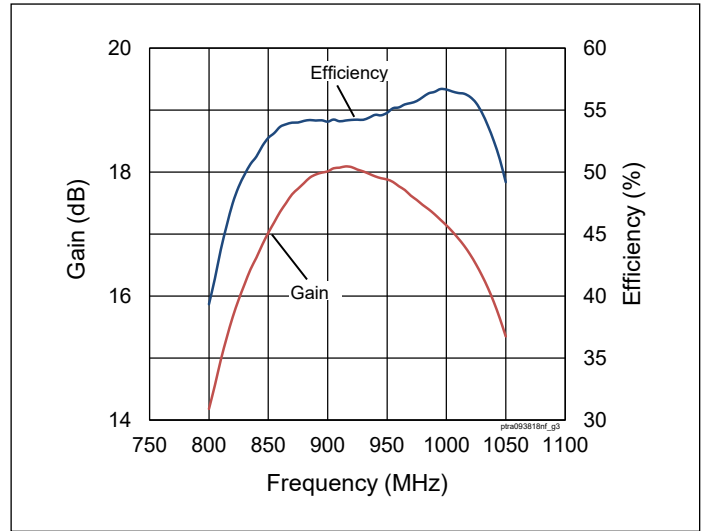

Figure 2. Single-carrier WCDMA Broadband Performance

$V_{DD} = 48\text{ V}$, $I_{DQ(MAIN)} = 200\text{ mA}$,
 $V_{GS(PEAK)} = 2.0\text{ V}$, $P_{OUT} = 49.1\text{ dBm}$,
 3GPP WCDMA signal, PAR = 10 dB

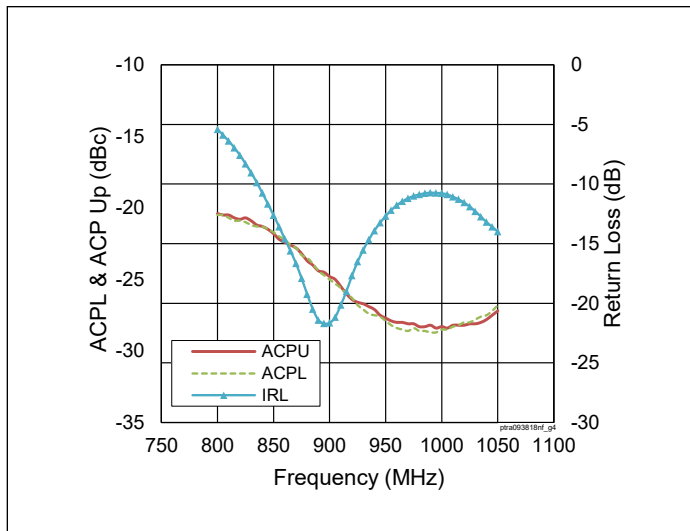

Figure 3. Single-carrier WCDMA Broadband Performance

$V_{DD} = 48\text{ V}$, $I_{DQ(MAIN)} = 200\text{ mA}$,
 $V_{GS(PEAK)} = 2.0\text{ V}$, $P_{OUT} = 49.1\text{ dBm}$,
 3GPP WCDMA signal. PAR = 10 dB

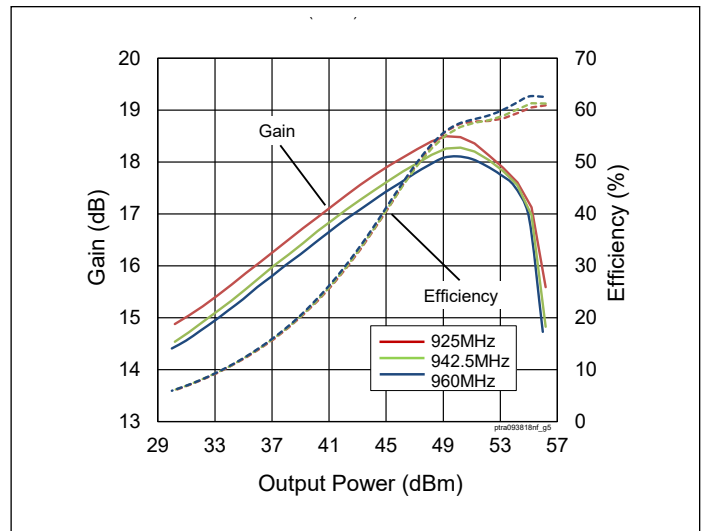

Figure 4. CW Performance

$V_{DD} = 48\text{ V}$, $I_{DQ(MAIN)} = 200\text{ mA}$,
 $V_{GS(PEAK)} = 2.0\text{ V}$

Typical Performance (cont.)

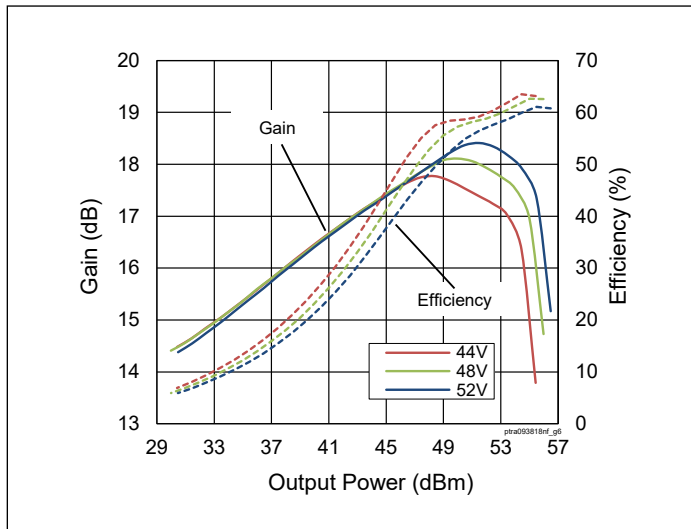

Figure 5. CW Performance at various V_{DD}

$I_{DQ(MAIN)} = 200 \text{ mA}$, $V_{GS(PEAK)} = 2.0 \text{ V}$,
 $f = 960 \text{ MHz}$

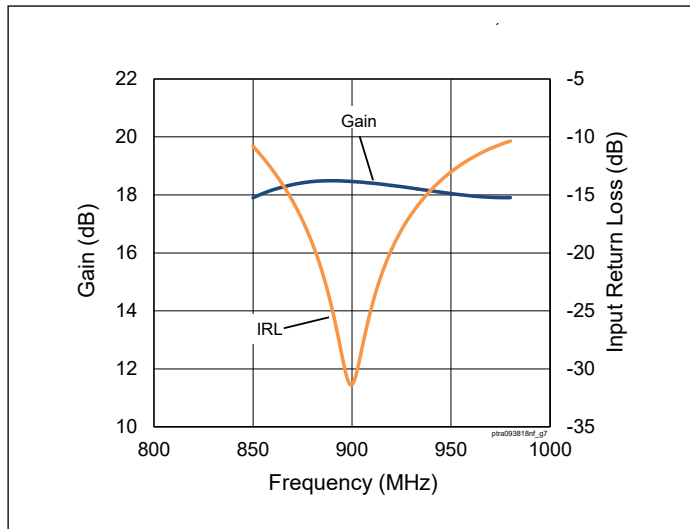

Figure 6. CW Performance Small Signal Gain & Input Return Loss

$V_{DD} = 48 \text{ V}$, $I_{DQ(MAIN)} = 200 \text{ mA}$,
 $V_{GS(PEAK)} = 2.0 \text{ V}$

Load Pull Performance

Main Side Load Pull Performance – Pulsed CW signal: 10 μ sec, 10% duty cycle, $V_{DD} = 48$ V, $I_{DQ} = 350$ mA, class AB

P_{1dB}											
Max Output Power							Max Drain Efficiency				
Freq [MHz]	Z_S [Ω]	Z_L [Ω]	Gain [dB]	P_{1dB} [dBm]	P_{1dB} [W]	η_D [%]	Z_L [Ω]	Gain [dB]	P_{1dB} [dBm]	P_{1dB} [W]	η_D [%]
925	2.34-j5.57	2.03-j1.79	19.7	53.30	216	60.0	3.40-j0.14	21.4	52.00	159	70.6
940	2.38-j5.42	2.09-j1.85	19.8	53.10	206	59.0	3.44-j0.44	21.5	51.70	147	69.3
960	3.96-j5.20	2.07-j1.66	20	53.10	205	61.0	3.33-j0.07	21.5	51.60	144	69.2

P_{3dB}											
Max Output Power							Max Drain Efficiency				
Freq [MHz]	Z_S [Ω]	Z_L [Ω]	Gain [dB]	P_{3dB} [dBm]	P_{3dB} [W]	η_D [%]	Z_L [Ω]	Gain [dB]	P_{3dB} [dBm]	P_{3dB} [W]	η_D [%]
925	2.34-j5.57	2.13-j2.00	17.8	54.13	259	62.6	3.49-j0.40	19.4	52.76	189	72.1
940	2.38-j5.42	2.14-j2.24	17.8	53.91	246	60.0	4.01-j0.08	19.8	52.04	160	70.6
960	3.96-j5.20	2.19-j2.31	17.9	53.87	244	60.6	3.44-j0.18	19.5	52.28	169	70.7

Peak Side Load Pull Performance – Pulsed CW signal: 10 μ sec, 10% duty cycle, $V_{DD} = 48$ V, $V_{GS(PEAK)} = 2$ V, class C

P_{1dB}											
Max Output Power							Max Drain Efficiency				
Freq [MHz]	Z_S [Ω]	Z_L [Ω]	Gain [dB]	P_{1dB} [dBm]	P_{1dB} [W]	η_D [%]	Z_L [Ω]	Gain [dB]	P_{1dB} [dBm]	P_{1dB} [W]	η_D [%]
925	1.92-j4.34	1.06-j2.15	15.3	55.05	320	59.7	1.0-j0.86	16.4	52.56	180	72.8
940	2.49-j4.58	1-j2.17	15.48	55.05	320	59.4	1-j0.84	16.4	52.20	166	71.9
960	3.20-j5.21	1.12-j2.37	15.54	55.00	316	59.0	1.06-j1.12	16.5	52.67	185	70.4

P_{3dB}											
Max Output Power							Max Drain Efficiency				
Freq [MHz]	Z_S [Ω]	Z_L [Ω]	Gain [dB]	P_{3dB} [dBm]	P_{3dB} [W]	η_D [%]	Z_L [Ω]	Gain [dB]	P_{3dB} [dBm]	P_{3dB} [W]	η_D [%]
925	1.92-j4.34	1.33-j2.18	13.5	55.74	375	63.5	1.09-j0.98	14.4	53.57	228	72.7
940	2.49-j4.58	1.38-j2.45	13.3	55.70	372	59.4	1.04-j0.95	14.47	53.20	209	71.5
960	3.20-j5.21	1.04-j2.47	13.4	55.67	369	59.1	1.1-j1.26	14.57	53.50	224	70.0

Evaluation Board, 925 – 960 MHz

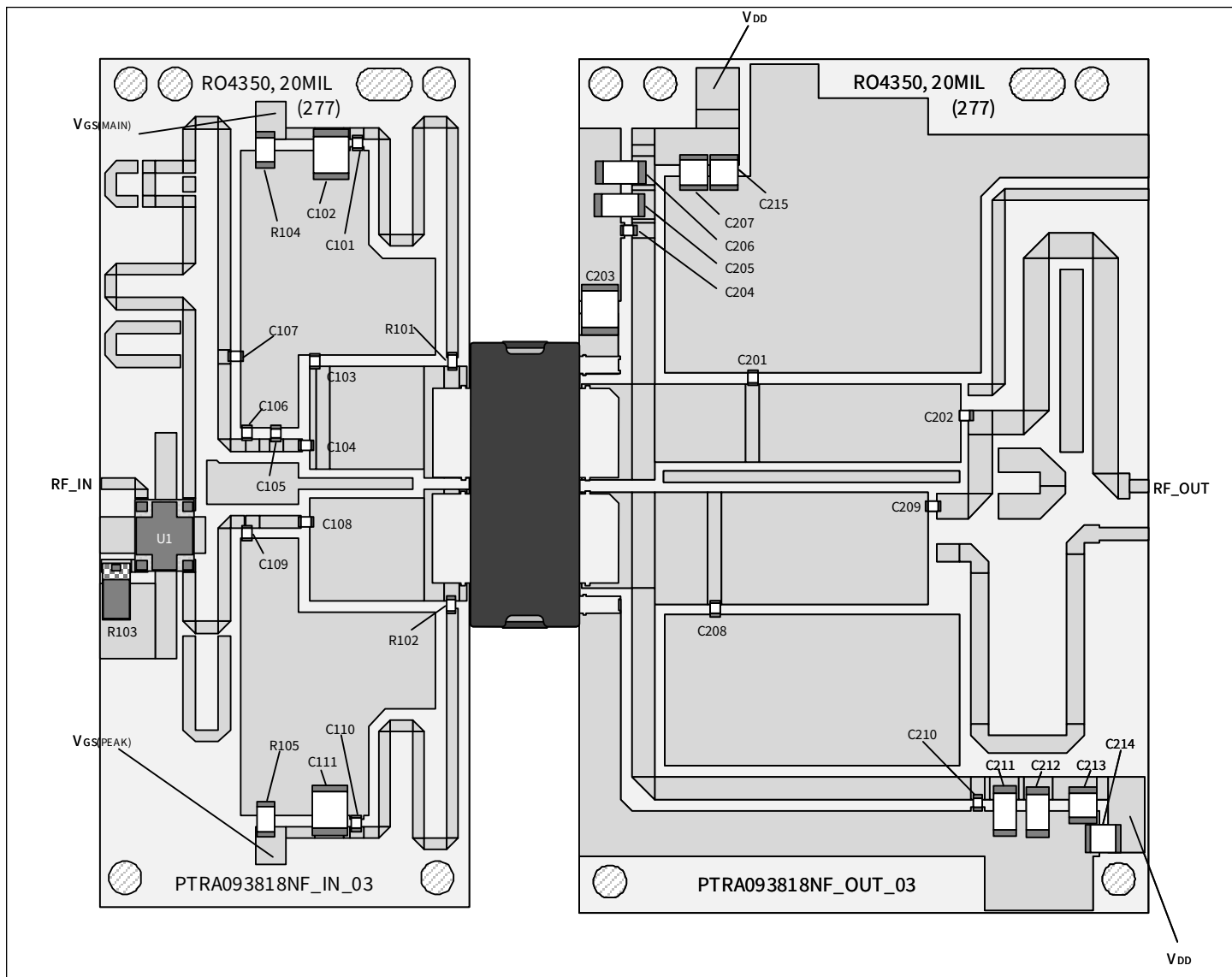

Reference circuit assembly diagram (not to scale)

Evaluation Board Part Number	LTA/PTRA093818NF-V1
PCB Information	Rogers 4350, 0.508 mm [0.020"] thick, 2 oz. copper, $\epsilon_r = 3.66$, $f = 925 - 960$ MHz

Components Information

Component	Description	Manufacturer	P/N
Input			
C101, C104, C108, C110	Capacitor, 43 pF	ATC	ATC600F430JW250T
C102, C111	Capacitor, 4.7 μ F	TDK Corporation	C4532X7S2A475M230KB
C103	Capacitor, 3.3 pF	ATC	ATC600F3R3CW250T
C105	Capacitor, 2.2 pF	ATC	ATC600F2R2CW250T
C106, C109	Capacitor, 6.2 pF	ATC	ATC600F6R2CW250T
C107	Capacitor, 1.8 pF	ATC	ATC600F1R8CW250T
R101, R102	Resistor, 10 ohms	Panasonic Electronic Components	ERJ-3GEYJ100V
R103	Resistor, 50 ohms	Anaren	C16A50Z4
R104, R105	Resistor, 1K ohms	Panasonic Electronic Components	ERJ-8GEYJ102V
U1	Hybrid Coupler	Anaren	X3C09P1-04S
Output			
C201, C208	Capacitor, 6.2 pF	ATC	ATC600F6R2CW250T
C202	Capacitor, 10 pF	ATC	ATC600F100JW250T
C203, C205, C206, C211, C212	Capacitor, 4.7 μ F	TDK Corporation	C4532X7S2A475M230KB
C204, C209, C210	Capacitor, 43 pF	ATC	ATC600F430JW250T
C207, C213, C214, C215	Capacitor, 10 μ F	MURATA	GRM32EC72A106KE05

Pinout Diagram (top view)

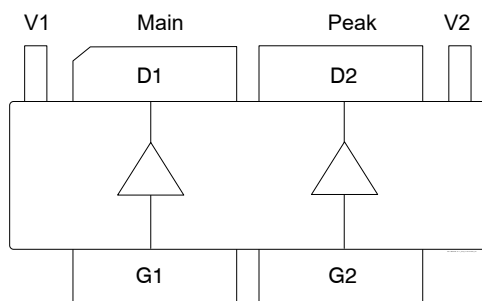

Pin	Description
D1	Drain Device 1 (Main)
D2	Drain Device 2 (Peak)
G1	Gate Device 1 (Main)
G2	Gate Device 2 (Peak)
S	Source (flange)
V1	Drain video decoupling, no DC bias
V2	NC or connected to GRD

Package Outline Specifications – Package PG-HBSOF-6-2 (top view)

Diagram Notes—unless otherwise specified:

1. Mold/dam bar/metal protrusion of 0.30 mm max per side not included.
2. Metal protrusions are connected to source and shall not exceed 0.10 mm max.
3. Fillets and radii: all radii are 0.3 mm max.
4. Interpret dimensions and tolerances per ISO 8015.
5. Dimensions are mm.
6. Does not include mold/dam bar and metal protrusion.
7. Exposed metal surface is tin-plated, may not be covered by mold compound.
8. All tolerances ± 0.1 mm unless specified otherwise.
9. All metal surfaces are tin-plated, except area of cut.
10. Lead thickness: 0.25 mm.
11. Pins: D1, D2 = drain; G1, G2 = gate; S = source; V1 = drain video decoupling, no DC Bias, V2 = NC or connected to GRD

Package Outline Specifications (cont.) – Package PG-HBSOF-6-2 (bottom view)

Diagram Notes—unless otherwise specified:

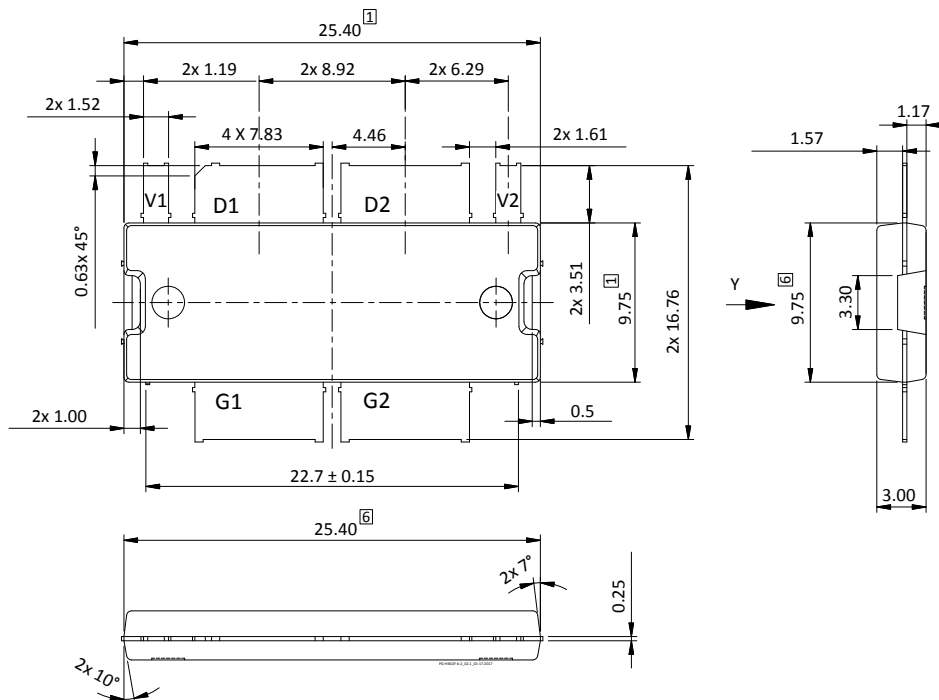
1. Mold/dam bar/metal protrusion of 0.30 mm max per side not included.
2. Metal protrusions are connected to source and shall not exceed 0.10 mm max.
3. Fillets and radii: all radii are 0.3 mm max.
4. Interpret dimensions and tolerances per ISO 8015.
5. Dimensions are mm.
6. Does not include mold/dam bar and metal protrusion.
7. Exposed metal surface is tin-plated, may not be covered by mold compound.
8. All tolerances ± 0.1 mm unless specified otherwise.
9. All metal surfaces are tin-plated, except area of cut.
10. Lead thickness: 0.25 mm.
11. Pins: D1, D2 = drain; G1, G2 = gate; S = source; V1 = drain video decoupling, no DC Bias, V2 = NC or connected to GRD

Notes & Disclaimer

MACOM Technology Solutions Inc. ("MACOM"). All rights reserved.

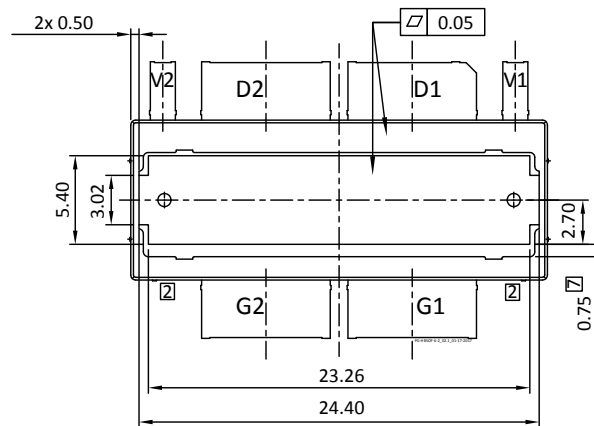
These materials are provided in connection with MACOM's products as a service to its customers and may be used for informational purposes only. Except as provided in its Terms and Conditions of Sale or any separate agreement, MACOM assumes no liability or responsibility whatsoever, including for (i) errors or omissions in these materials; (ii) failure to update these materials; or (iii) conflicts or incompatibilities arising from future changes to specifications and product descriptions, which MACOM may make at any time, without notice. These materials grant no license, express or implied, to any intellectual property rights.

THESE MATERIALS ARE PROVIDED "AS IS" WITH NO WARRANTY OR LIABILITY, EXPRESS OR IMPLIED, RELATING TO SALE AND/OR USE OF MACOM PRODUCTS INCLUDING FITNESS FOR A PARTICULAR PURPOSE, MERCHANTABILITY, INFRINGEMENT OF INTELLECTUAL PROPERTY RIGHT, ACCURACY OR COMPLETENESS, OR SPECIAL, INDIRECT, INCIDENTAL, OR CONSEQUENTIAL DAMAGES WHICH MAY RESULT FROM USE OF THESE MATERIALS.

MACOM products are not intended for use in medical, lifesaving or life sustaining applications. MACOM customers using or selling MACOM products for use in such applications do so at their own risk and agree to fully indemnify MACOM for any damages resulting from such improper use or sale.

Mouser Electronics

Authorized Distributor

Click to View Pricing, Inventory, Delivery & Lifecycle Information:

[MACOM:](#)

[LTA/PTRA093818NF-V1](#)