

GTRA263902FC

Thermally-Enhanced High Power RF GaN on SiC Amplifier, 370 W, 48 V, 2495 – 2690 MHz

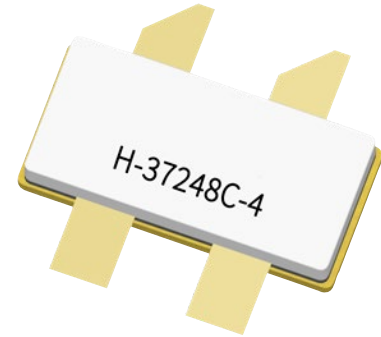

Package Types: H-37248C-4
PN: GTRA263902FC

Description

The GTRA263902FC is a 370-watt (P_{3dB}) GaN on SiC HEMT D-mode amplifier for use in multi-standard cellular power amplifier applications. It features input matching, high efficiency, and a thermally-enhanced package with earless flange.

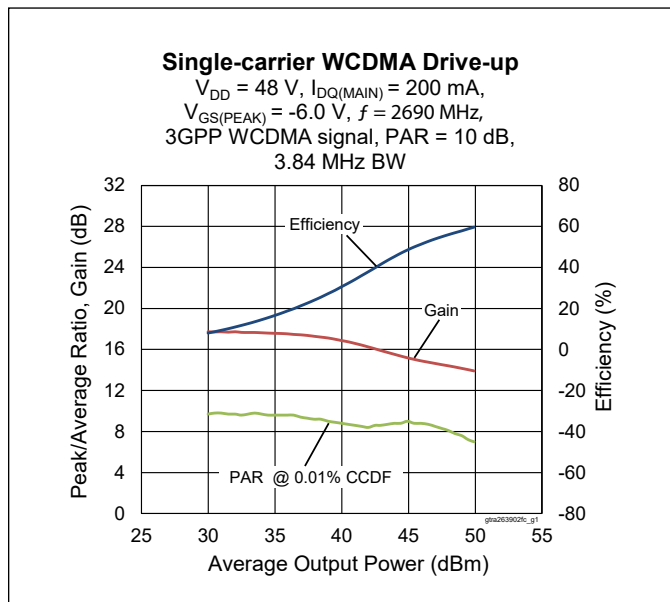

Features

- GaN on SiC HEMT technology
- Input matched
- Typical Pulsed CW performance, 2690 MHz, 48 V, combined outputs
 - Output power at $P_{3dB} = 370\text{ W}$
 - Efficiency = 70%
 - Gain = 15 dB
- Capable of handling 10:1 VSWR @48 V, 56 W (CW) output power
- Human Body Model class 1A (per ANSI/ESDA/ JEDEC JS-001)
- Low thermal resistance
- Pb-free and RoHS compliant

RF Characteristics

Single-carrier WCDMA Specifications (tested in the Doherty production test fixture)

$V_{DD} = 48\text{ V}$, $I_{DQ} = 200\text{ mA}$, $V_{GS(PEAK)} = V_{GS} @ I_{DQ} = 280\text{ mA} -3.0\text{ V}$, $P_{OUT} = 56.2\text{ W avg}$, $f = 2690\text{ MHz}$, 3GPP signal, channel bandwidth = 3.84 MHz, peak/average = 10 dB @ 0.01% CCDF

Characteristic	Symbol	Min.	Typ.	Max.	Unit
Linear Gain	G_{ps}	12.5	13.8	—	dB
Drain Efficiency	η_D	50	54	—	%
Adjacent Channel Power Ratio	ACPR	—	-27	-23	dBc
Output PAR @ 0.01% CCDF	OPAR	5	6.7	—	dB

Note:

All published data at $T_{CASE} = 25^\circ\text{C}$ unless otherwise indicated

ESD: Electrostatic discharge sensitive device—observe handling precautions!



DC Characteristics

Characteristic	Symbol	Min.	Typ.	Max.	Unit	Conditions
Drain-source Breakdown Voltage (Main)	$V_{BR(DSS)}$	150	—	—	V	$V_{GS} = -8\text{ V}, I_D = 10\text{ mA}$
Drain-source Breakdown Voltage (Peak)						$V_{GS} = -8\text{ V}, I_{DS} = 10\text{ mA}$
Drain-source Leakage Current (Main)	I_{DSS}	—	—	2.7	mA	$V_{GS} = -8\text{ V}, V_{DS} = 10\text{ V}$
Gate Threshold Voltage (main)	$V_{GS(th)}$	-3.8	-3	-2.3	V	$V_{DS} = 10\text{ V}, I_D = 20\text{ mA}$
Gate Threshold Voltage (peak)						$V_{DS} = 10\text{ V}, I_D = 28.8\text{ mA}$

Recommended Operating Conditions

Parameter	Symbol	Min.	Typ.	Max.	Unit	Conditions
Operating Voltage	V_{DD}	0	—	55	V	
Gate Quiescent Voltage	$V_{GS(Q)}$	—	-3	—		$V_{DS} = 48\text{ V}, I_D = 200\text{ mA}$

Absolute Maximum Ratings

Parameter	Symbol	Value	Unit
Drain-source Voltage	V_{DSS}	125	V
Gate-source Voltage	V_{GS}	-10 to +2	
Gate Current	I_G	20	mA
Drain Current	I_D	7.5	A
Junction Temperature	T_J	225	°C
Storage Temperature Range	T_{STG}	-65 to +150	

Operation above the maximum values listed here may cause permanent damage. Maximum ratings are absolute ratings; exceeding only one of these values may cause irreversible damage to the component. Exposure to absolute maximum rating conditions for extended periods may affect device reliability. For reliable continuous operation, the device should be operated within the operating voltage range (V_{DD}) specified above.

Thermal Characteristics

Characteristics	Symbol	Value	Unit	Conditions
Thermal Resistance (main)	$R_{\theta JC}$	1.8	°C/W	$T_{CASE} = 70^\circ\text{C}, P_{DISS} = 77\text{ DC}$

Ordering Information

Type and Version	Order Code	Package Description	Shipping
GTRA263902FC V2 R0	GTRA263902FC-V2-R0	H-37248C-4, earless flange	Tape & Reel, 50 pcs
GTRA263902FC V2 R2	GTRA263902FC-V2-R2	H-37248C-4, earless flange	Tape & Reel, 250 pcs

Typical RF Performance (data taken in production test fixture)

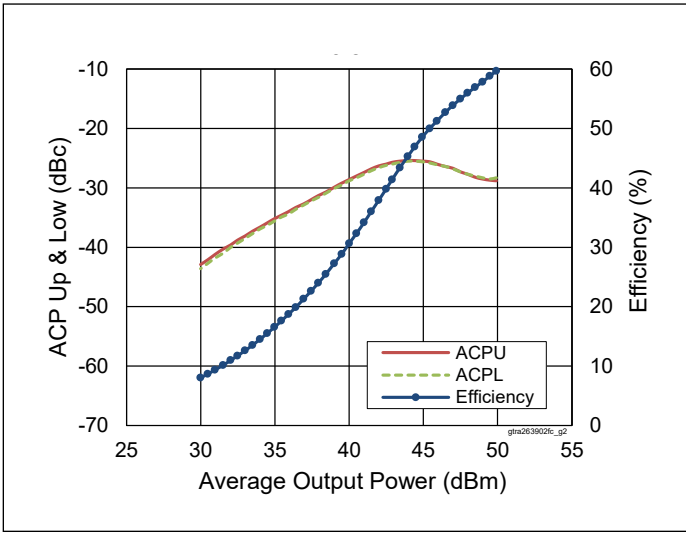

Figure 1. Single-carrier WCDMA Drive-up

$V_{DD} = 48\text{ V}$, $I_{DQ(MAIN)} = 200\text{ mA}$,
 $V_{GS(PEAK)} = -6.0\text{ V}$, $f = 2690\text{ MHz}$,
 3GPP WCDMA signal, PAR = 10 dB,
 BW = 3.84 MHz

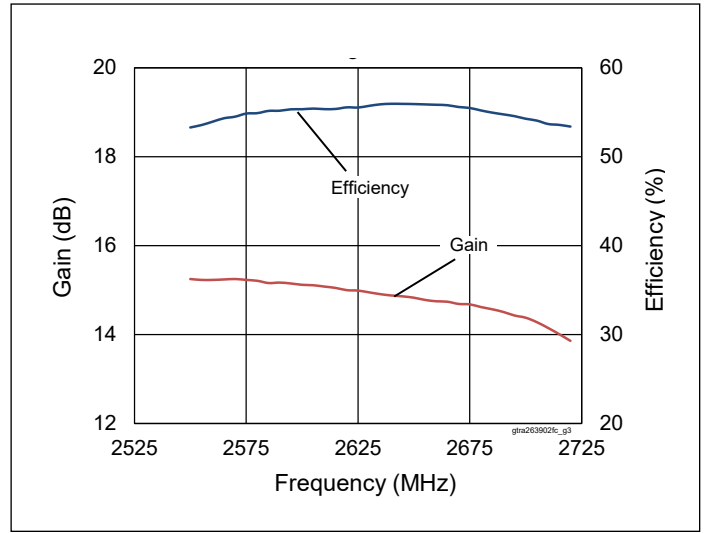

Figure 2. Single-carrier WCDMA Broadband Performance

$V_{DD} = 48\text{ V}$, $I_{DQ(MAIN)} = 200\text{ mA}$,
 $V_{GS(PEAK)} = -6.0\text{ V}$, $P_{OUT} = 47.5\text{ dBm}$,
 3GPP WCDMA signal, PAR = 10 dB

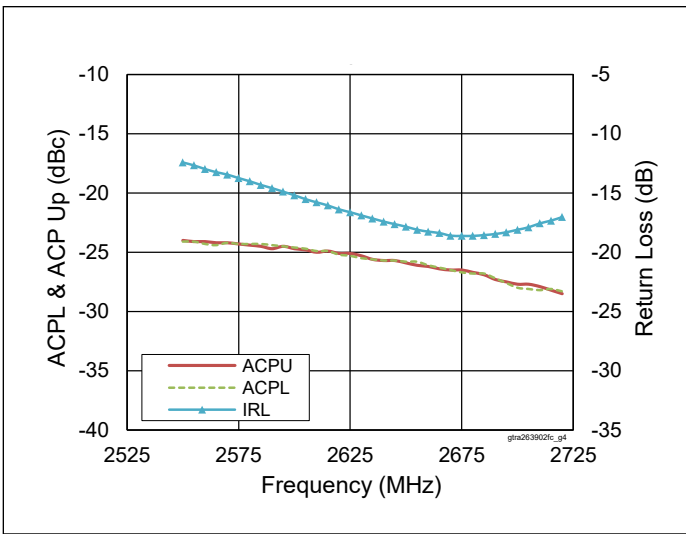

Figure 3. Single-carrier WCDMA Broadband Performance

$V_{DD} = 48\text{ V}$, $I_{DQ(MAIN)} = 200\text{ mA}$,
 $V_{GS(PEAK)} = -6.0\text{ V}$, $P_{OUT} = 47.5\text{ dBm}$,
 3GPP WCDMA signal, PAR = 10 dB

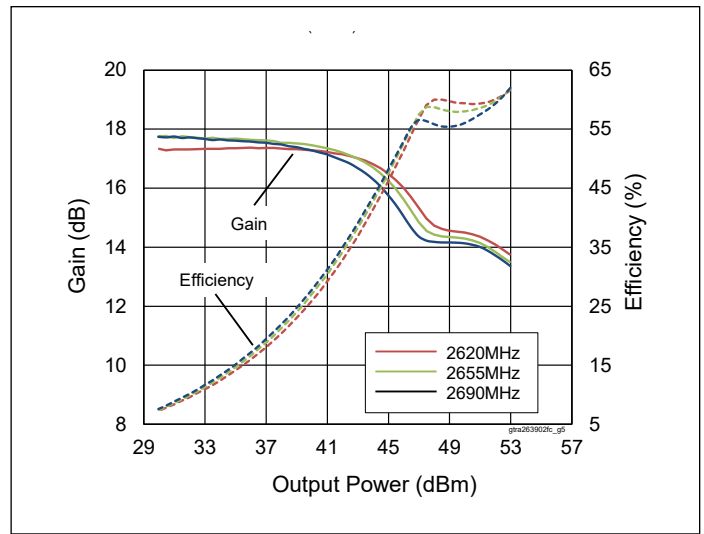

Figure 4. CW Performance

$V_{DD} = 48\text{ V}$, $I_{DQ(MAIN)} = 200\text{ mA}$,
 $V_{GS(PEAK)} = -6.0\text{ V}$

Typical RF Performance (cont.)

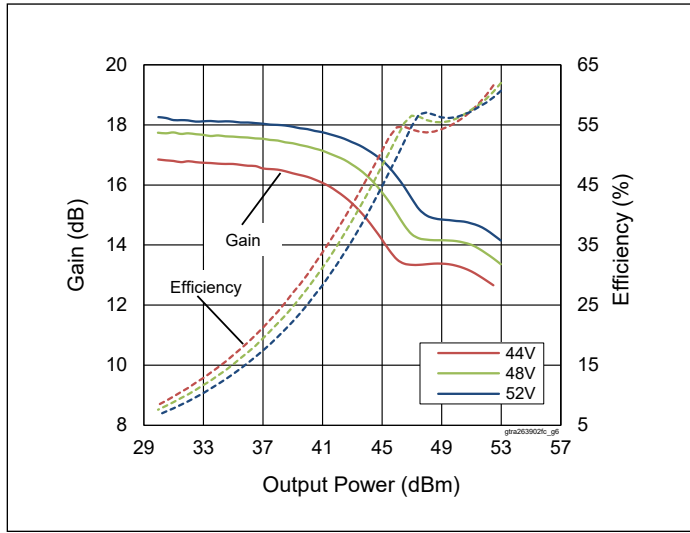

Figure 5. CW Performance at various V_{DD}

$I_{DQ(MAIN)} = 200 \text{ mA}$, $V_{GS(PEAK)} = -6.0 \text{ V}$,
 $f = 2690 \text{ MHz}$

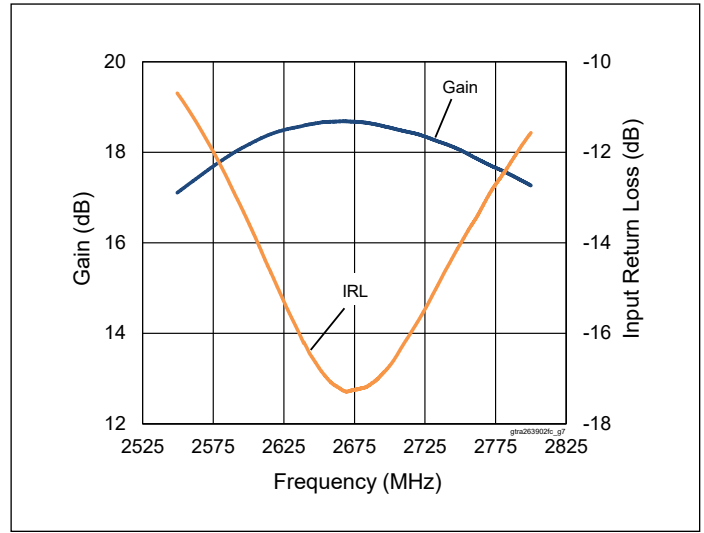

Figure 6. CW Performance Small Signal Gain & Input Return Loss

$V_{DD} = 48 \text{ V}$, $I_{DQ(MAIN)} = 200 \text{ mA}$,
 $V_{GS(PEAK)} = -6.0 \text{ V}$

Load Pull Performance

Main Side Load Pull Performance - Pulsed CW signal: 10 μs , 10% duty cycle, 48 V, $I_{DQ} = 200 \text{ mA}$, class AB

		P_{3dB}									
		Max Output Power					Max Drain Efficiency				
Freq [MHz]	$Z_s [\Omega]$	$Z_l [\Omega]$	Gain [dB]	P_{3dB} [dBm]	P_{3dB} [W]	η_D [%]	$Z_l [\Omega]$	Gain [dB]	P_{3dB} [dBm]	P_{3dB} [W]	η_D [%]
2620	10.4 - j6.7	3.88 - j4.7	16.37	52.80	190.55	65.2	2.84 - j2.35	18.15	50.98	125.3	75.3
2690	7.6 - j6.7	3.91 - j5.35	15.79	52.85	192.75	62.4	2.55 - j2.27	18.05	50.69	117.2	76.6

Peak Side Load Pull Performance - Pulsed CW signal: 10 μs , 10% duty cycle, 48 V, $V_{GS(PEAK)} = -5 \text{ V}$, class C

		P_{3dB}									
		Max Output Power					Max Drain Efficiency				
Freq [MHz]	$Z_s [\Omega]$	$Z_l [\Omega]$	Gain [dB]	P_{3dB} [dBm]	P_{3dB} [W]	η_D [%]	$Z_l [\Omega]$	Gain [dB]	P_{3dB} [dBm]	P_{3dB} [W]	η_D [%]
2620	16.8 - j16.8	2.35 - j3.92	14.72	54.55	285.1	68.1	1.68 - j2.17	16	52.29	169.43	77.6
2690	20 - j7.5	2.5 - j4.37	14.32	54.67	293.1	66.4	2.14 - j2.52	15.3	53.12	205.11	77.7

Reference Circuit, 2620 – 2690 MHz

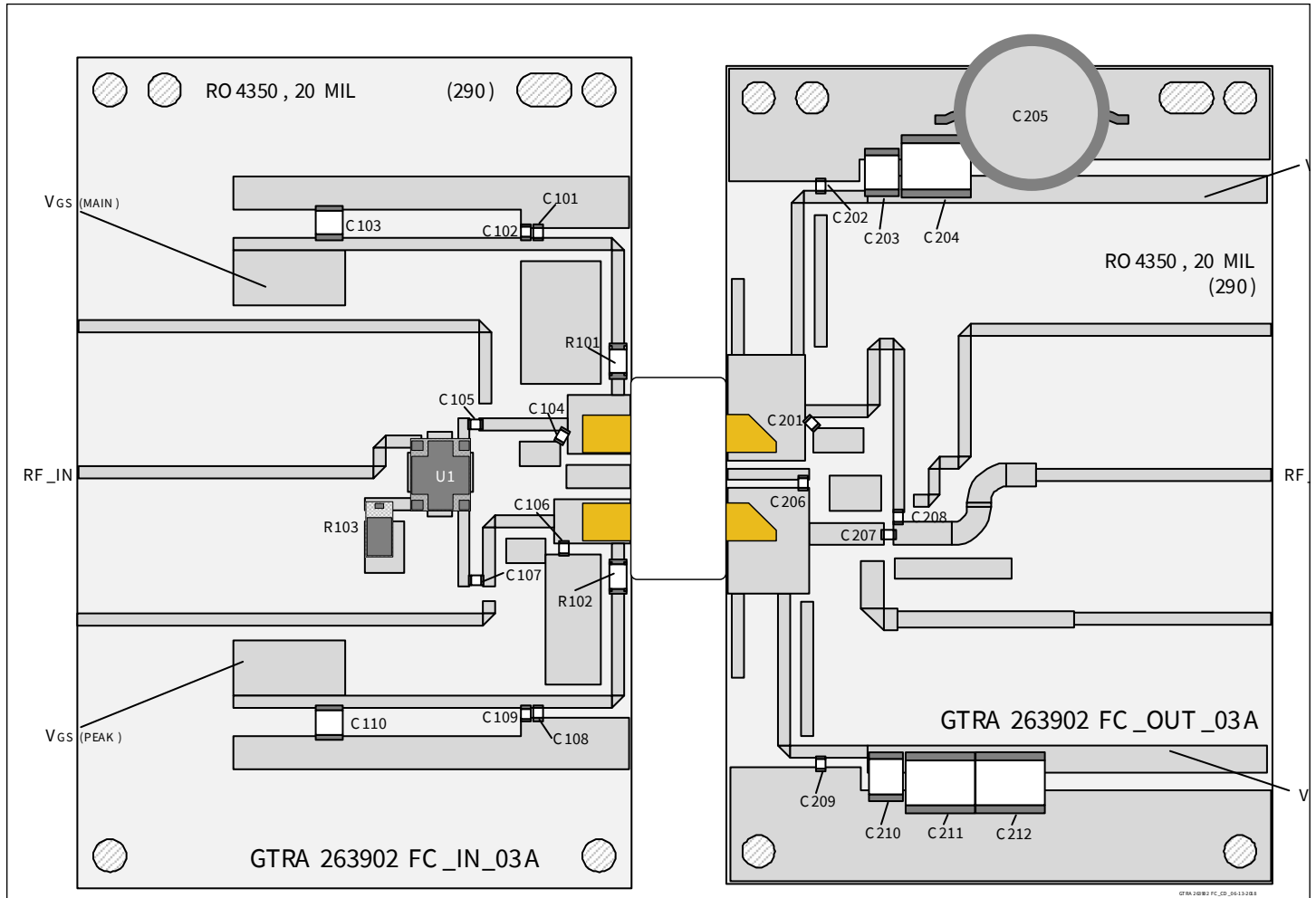

Reference circuit assembly diagram (not to scale)

Reference Circuit Assembly

DUT	GTRA263902FC-V2
Test Fixture Part No.	LTA/GTRA263902FC-V2
PCB	Rogers 4350, 0.508 mm [0.020"] thick, 2 oz. copper, $\epsilon_r = 3.66$, $f = 2620 - 2690$ MHz

Components Information

Component	Description	Manufacturer	P/N
Input			
C101, C105, C107, C108	Capacitor, 10 pF	ATC	ATC800A100JT250T
C102, C109	Capacitor, 1 μ F	Murata Electronics North America	GRM21BR71H105KA12L
C103, C110	Capacitor, 10 μ F	Taiyo Yuden	UMK325C7106MM-T
C104	Capacitor, 1.0 pF	ATC	ATC600S1R0JT250T
C106	Capacitor, 1.2 pF	ATC	ATC600S1R2JT250T
R101, R102	Resistor, 5.6 ohms	Panasonic Electronic Components	ERJ-8RQJ5R6V
R103	Resistor, 50 ohms	Richardson	C16A50Z4
U1	Hybrid Coupler	Anaren	X3C26P1-03S
Output			
C201, C206	Capacitor, 1.5 pF	ATC	ATC600S1R5JT250T
C202, C209	Capacitor, 10 pF	ATC	ATC800A100JT250T
C203, C210	Capacitor, 1 μ F	TDK Corporation	C4532X7R2A105M230KA
C204, C211, C212	Capacitor, 10 μ F	AVX Corporation	2225PC105KAT1A
C205	Capacitor, 220 μ F	Panasonic Electronic Components	ECA-2AHG221
C207, C208	Capacitor, 10 pF	ATC	ATC600F100JW250T

Pinout Diagram (top view)

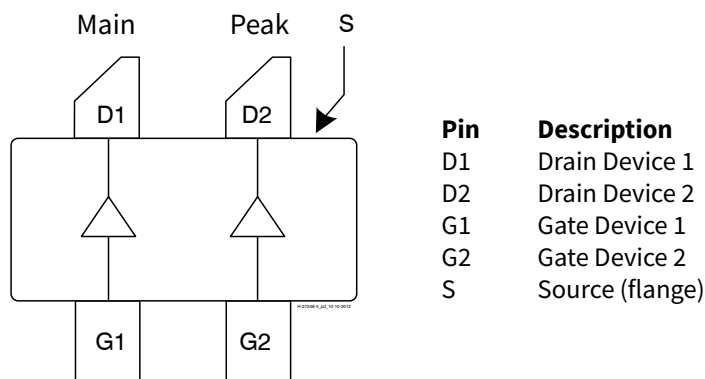

Package Outline Specifications (top view) – Package H-37248C-4

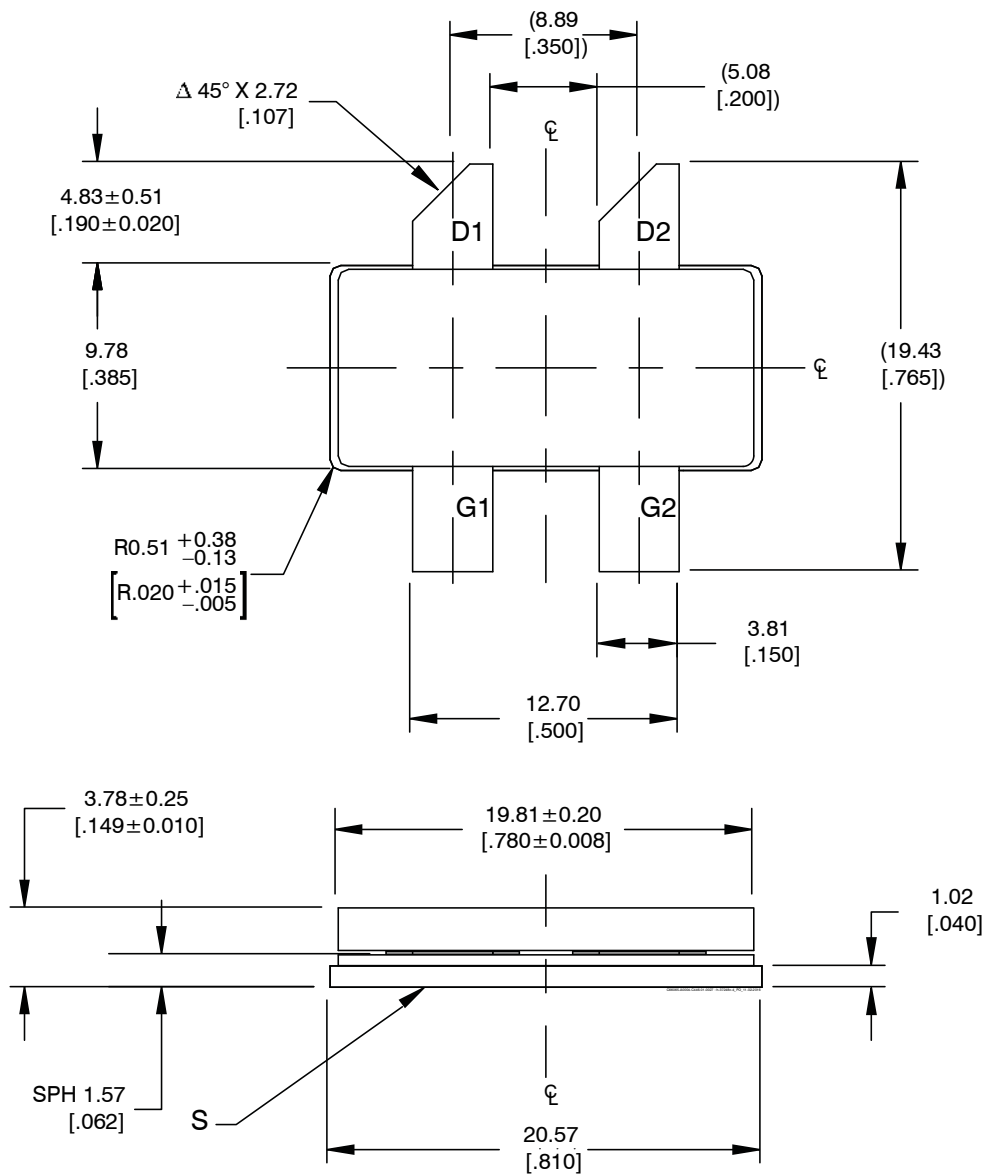

Diagram Notes—unless otherwise specified:

1. Interpret dimensions and tolerances per ASME Y14.5M-1994
2. Primary dimensions are mm, alternate dimensions are inches
3. All tolerances ± 0.127 [0.005]
4. Pins: D1, D2 – drain, G1, G2 – gate, S – source (flange)
5. Lead thickness: 0.13 ± 0.05 [0.005 ± 0.002]
6. Gold plating thickness: 1.14 ± 0.38 micron [45 ± 15 microinch]

Notes & Disclaimer

MACOM Technology Solutions Inc. ("MACOM"). All rights reserved.

These materials are provided in connection with MACOM's products as a service to its customers and may be used for informational purposes only. Except as provided in its Terms and Conditions of Sale or any separate agreement, MACOM assumes no liability or responsibility whatsoever, including for (i) errors or omissions in these materials; (ii) failure to update these materials; or (iii) conflicts or incompatibilities arising from future changes to specifications and product descriptions, which MACOM may make at any time, without notice. These materials grant no license, express or implied, to any intellectual property rights.

THESE MATERIALS ARE PROVIDED "AS IS" WITH NO WARRANTY OR LIABILITY, EXPRESS OR IMPLIED, RELATING TO SALE AND/OR USE OF MACOM PRODUCTS INCLUDING FITNESS FOR A PARTICULAR PURPOSE, MERCHANTABILITY, INFRINGEMENT OF INTELLECTUAL PROPERTY RIGHT, ACCURACY OR COMPLETENESS, OR SPECIAL, INDIRECT, INCIDENTAL, OR CONSEQUENTIAL DAMAGES WHICH MAY RESULT FROM USE OF THESE MATERIALS.

MACOM products are not intended for use in medical, lifesaving or life sustaining applications. MACOM customers using or selling MACOM products for use in such applications do so at their own risk and agree to fully indemnify MACOM for any damages resulting from such improper use or sale.

Mouser Electronics

Authorized Distributor

Click to View Pricing, Inventory, Delivery & Lifecycle Information:

[MACOM:](#)

[GTRA263902FC-V2-R0](#) [GTRA263902FC-V2-R2](#) [LTA/GTRA263902FC-V2](#)