

CMPA901A035F

35 W, 9.0 - 11.0 GHz, GaN MMIC, Power Amplifier

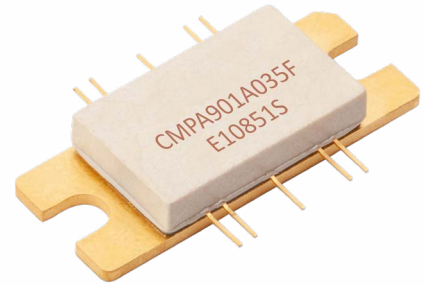

Description

The CMPA901A035F is a gallium nitride (GaN) high electron mobility transistor (HEMT) based monolithic microwave integrated circuit (MMIC) on a silicon carbide (SiC) substrate. The semiconductor offers 35 Watts of power from 9 to 11 GHz of instantaneous bandwidth. The GaN HEMT MMIC is housed in a thermally-enhanced, 10-lead 25 mm x 9.9 mm metal/ceramic flanged package. It offers high gain and superior efficiency in a small footprint package at 50 ohms.

Package Types: 440213
PN's: CMPA901A035F

Features

- 35 W typical P_{SAT}
- >33% typical power added efficiency
- 22.5 dB large signal gain
- High temperature operation

Applications

- Military radar
- Marine radar
- Weather radar
- Medical applications

Note:

Features are typical performance across frequency under 25 °C operation. Please reference performance charts for additional details.

Typical Performance Over 9.0 - 11.0 GHz ($T_c = 25\text{ °C}$)

Parameter	9.0 GHz	9.5 GHz	10.0 GHz	10.5 GHz	11.0 GHz	Units
Small Signal Gain ^{1,2}	34.8	32.4	32.7	33.2	32.6	dB
Output Power ^{1,3}	45.9	45.8	45.6	45.6	45.4	dBm
Power Gain ^{1,3}	22.9	22.8	22.6	22.6	22.4	dB
Power Added Efficiency ^{1,3}	37	34	33	33	34	%

Notes:

¹ $V_{DD} = 28\text{ V}$, $I_{DQ} = 1500\text{ mA}$.

² Measured at $P_{IN} = -20\text{ dBm}$.

³ Measured at $P_{IN} = 23\text{ dBm}$ and 300 μs ; duty cycle = 20%.



Absolute Maximum Ratings (Not Simultaneous) at 25 °C

Parameter	Symbol	Rating	Units	Conditions
Drain-Source Voltage	V_{DSS}	84	V_{DC}	25 °C
Gate-Source Voltage	V_{GS}	-10, +2	V_{DC}	25 °C
Storage Temperature	T_{STG}	-40, +150	°C	
Maximum Forward Gate Current	I_G	19	mA	25 °C
Maximum Drain Current	I_{DMAX}	5	A	
Soldering Temperature	T_s	260	°C	
Junction Temperature	T_J	225	°C	MTTF > 1e6 Hours

Electrical Characteristics (Frequency = 9.0 GHz to 11.0 GHz Unless Otherwise Stated; $T_c = 25 °C$)

Characteristics	Symbol	Min.	Typ.	Max.	Units	Conditions
DC Characteristics						
Gate Threshold Voltage	$V_{GS(th)}$	-3.8	-2.8	-2.3	V	$V_{DS} = 10 V, I_D = 19.8 mA$
Gate Quiescent Voltage	$V_{GS(Q)}$	-	-2.7	-	V_{DC}	$V_{DD} = 28 V, I_{DQ} = 1500 mA$
Saturated Drain Current ¹	I_{DS}	14.3	19.8	-	A	$V_{DS} = 6.0 V, V_{GS} = 2.0 V$
Drain-Source Breakdown Voltage	V_{BD}	84	-	-	V	$V_{GS} = -8 V, I_D = 19.8 mA$
RF Characteristics²						
Small Signal Gain	S21	-	34	-	dB	$P_{IN} = -23 dBm, Freq = 9.0 - 10.0 GHz$
Output Power	P_{OUT1}	-	45.7	-	dBm	$V_{DD} = 28 V, I_{DQ} = 1500 mA, P_{IN} = 23 dBm, Freq = 9.0 GHz$
Output Power	P_{OUT2}	-	44.7	-	dBm	$V_{DD} = 28 V, I_{DQ} = 1500 mA, P_{IN} = 23 dBm, Freq = 10.0 GHz$
Power Added Efficiency	PAE_1	-	40	-	%	$V_{DD} = 28 V, I_{DQ} = 1500 mA, P_{IN} = 23 dBm, Freq = 9.0 GHz$
Power Added Efficiency	PAE_2	-	37	-	%	$V_{DD} = 28 V, I_{DQ} = 1500 mA, P_{IN} = 23 dBm, Freq = 10.0 GHz$
Input Return Loss	S11	-	-6.4	-	dB	$P_{IN} = -23 dBm, 9.0 - 10.0 GHz$
Output Return Loss	S22	-	-6.8	-	dB	$P_{IN} = -23 dBm, 9.0 - 10.0 GHz$
Output Mismatch Stress	VSWR	-	5:1	-	Ψ	No Damage at All Phase Angles

Notes:

¹ Scaled from PCM data.

² Unless otherwise noted: Pulse width = 300 μs , duty cycle = 20%.

Thermal Characteristics

Parameter	Symbol	Rating	Units	Conditions
Operating Junction Temperature	T_J	159	°C	Pulse Width = 300 μs , Duty Cycle = 20% $P_{DISS} = 80 W, T_{CASE} = 85 °C$
Thermal Resistance, Junction to Case	$R_{\theta JC}$	0.93	°C/W	
Operating Junction Temperature	T_J	217	°C	$P_{DISS} = 80 W, T_{CASE} = 85 °C$
Thermal Resistance, Junction to Case	$R_{\theta JC}$	1.66	°C/W	

Typical Performance of the CMPA901A035F

Test conditions unless otherwise noted: $V_D = 28\text{ V}$, $I_{DQ} = 1500\text{ mA}$, pulse width = $300\ \mu\text{s}$, duty cycle = 20%, $P_{IN} = 23\text{ dBm}$, $T_{BASE} = +25\text{ }^\circ\text{C}$

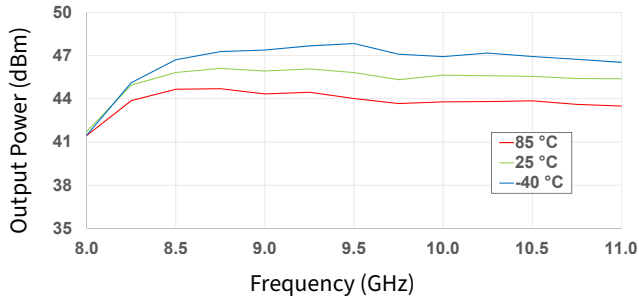

Figure 1. Output Power vs Frequency as a Function of Temperature

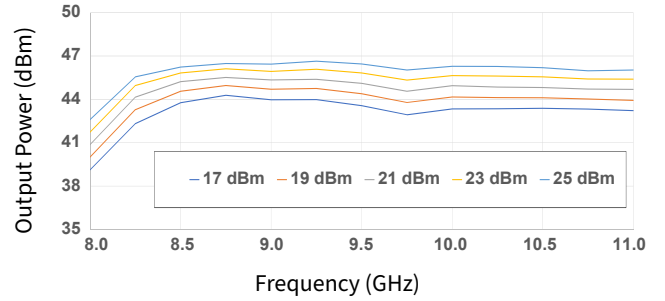

Figure 2. Output Power vs Frequency as a Function of Input Power

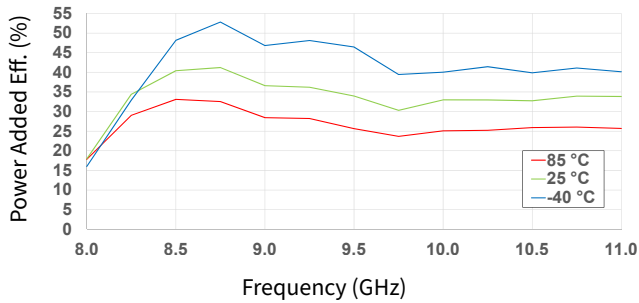

Figure 3. Power Added Eff. vs Frequency as a Function of Temperature

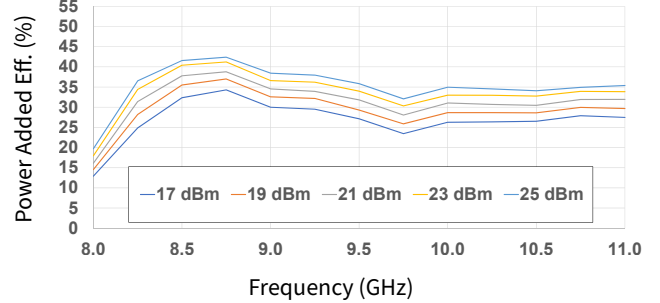

Figure 4. Power Added Eff. vs Frequency as a Function of Input Power

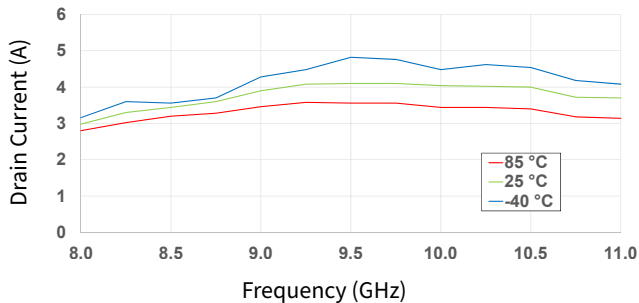

Figure 5. Drain Current vs Frequency as a Function of Temperature

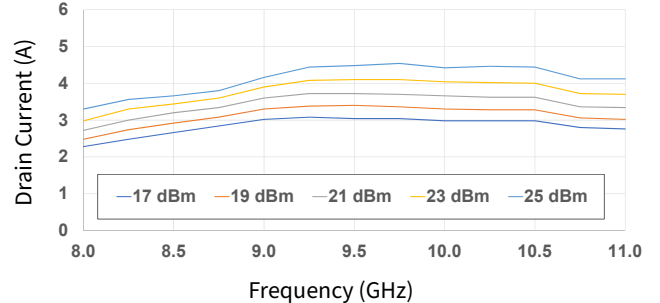

Figure 6. Drain Current vs Frequency as a Function of Input Power

Typical Performance of the CMPA901A035F

Test conditions unless otherwise noted: $V_D = 28\text{ V}$, $I_{DQ} = 1500\text{ mA}$, pulse width = $300\text{ }\mu\text{s}$, duty cycle = 20%, $P_{IN} = 23\text{ dBm}$, $T_{BASE} = +25\text{ }^\circ\text{C}$

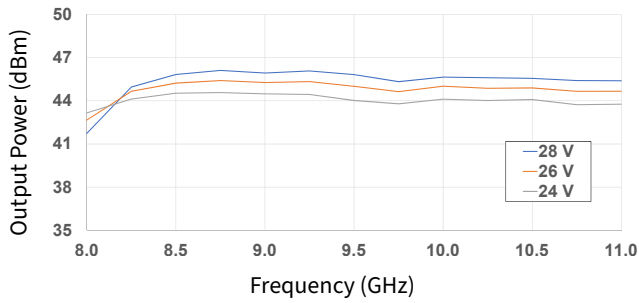

Figure 7. Output Power vs Frequency as a Function of V_D

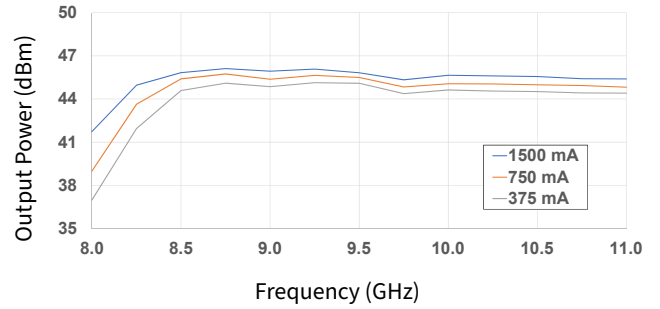

Figure 8. Output Power vs Frequency as a Function of I_{DQ}

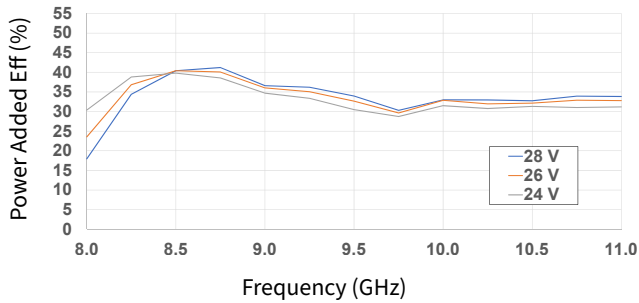

Figure 9. Power Added Eff. vs Frequency as a Function of V_D

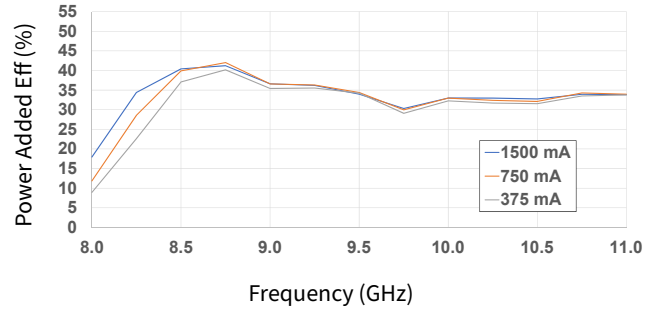

Figure 10. Power Added Eff. vs Frequency as a Function of I_{DQ}

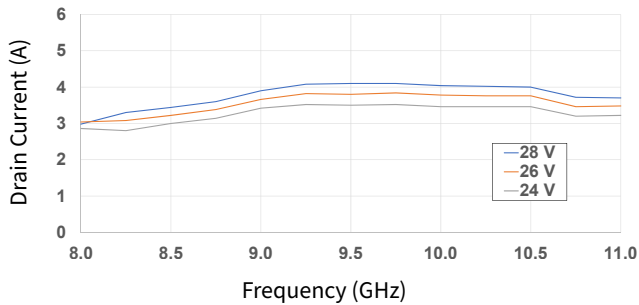

Figure 11. Drain Current vs Frequency as a Function of V_D

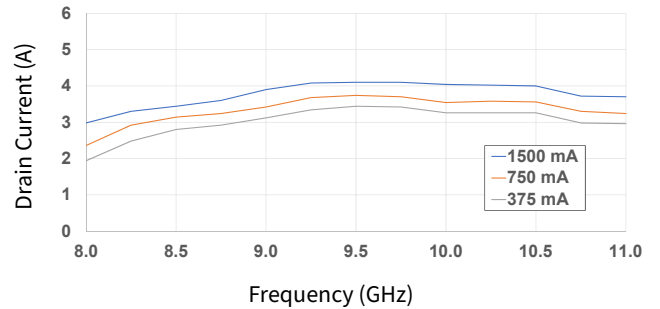

Figure 12. Drain Current vs Frequency as a Function of I_{DQ}

Typical Performance of the CPMA901A035F

Test conditions unless otherwise noted: $V_D = 28\text{ V}$, $I_{DQ} = 1500\text{ mA}$, pulse width = $300\text{ }\mu\text{s}$, duty cycle = 20%, $P_{IN} = 23\text{ dBm}$, $T_{BASE} = +25\text{ }^\circ\text{C}$

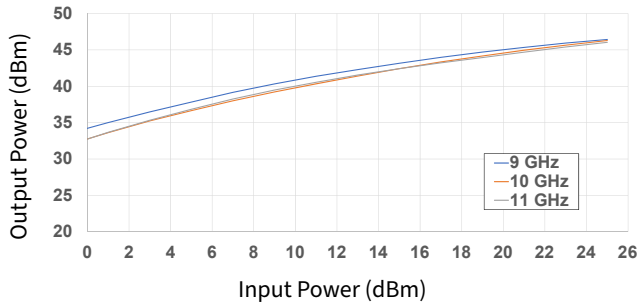

Figure 13. Output Power vs Input Power as a Function of Frequency

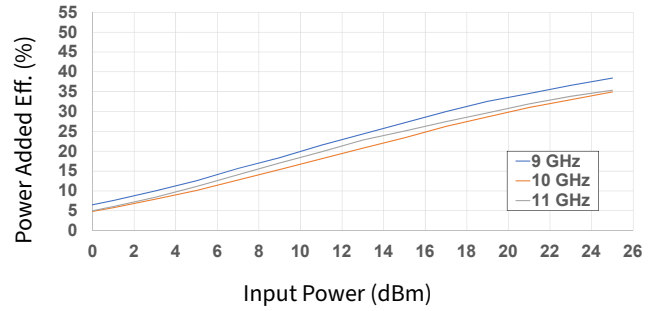

Figure 14. Power Added Eff. vs Input Power as a Function of Frequency

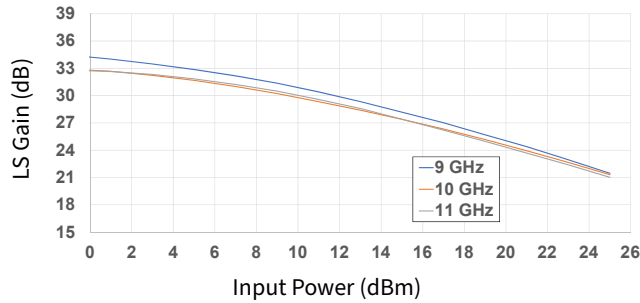

Figure 15. Large Signal Gain vs Input Power as a Function of Frequency

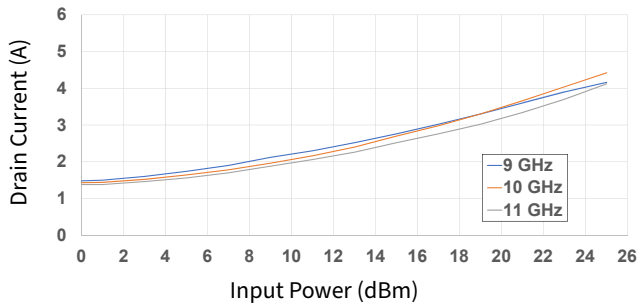

Figure 16. Drain Current vs Input Power as a Function of Frequency

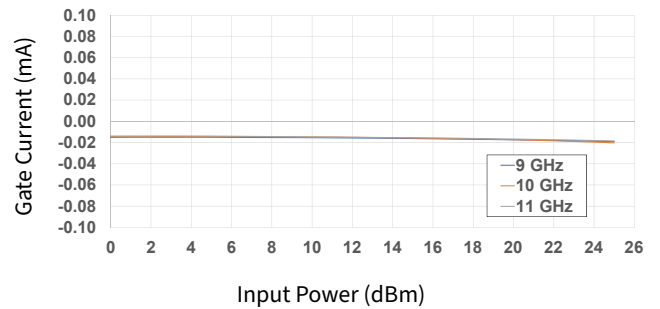

Figure 17. Gate Current vs Input Power as a Function of Frequency

Typical Performance of the CMPA901A035F

Test conditions unless otherwise noted: $V_D = 28\text{ V}$, $I_{DQ} = 1500\text{ mA}$, pulse width = $300\text{ }\mu\text{s}$, duty cycle = 20%, $P_{IN} = 23\text{ dBm}$, $T_{BASE} = +25\text{ }^\circ\text{C}$

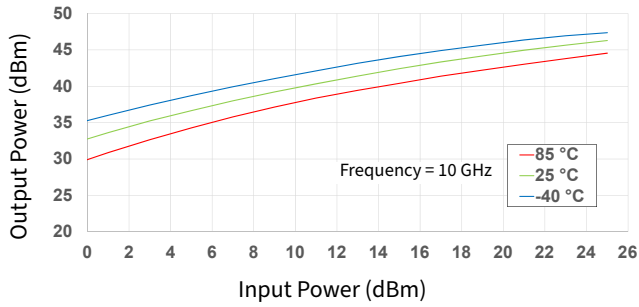

Figure 18. Output Power vs Input Power as a Function of Temperature

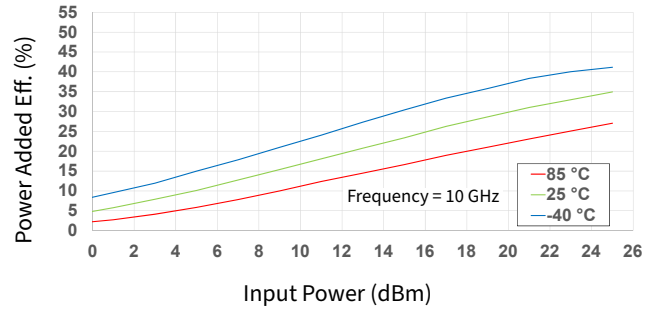

Figure 19. Power Added Eff. vs Input Power as a Function of Temperature

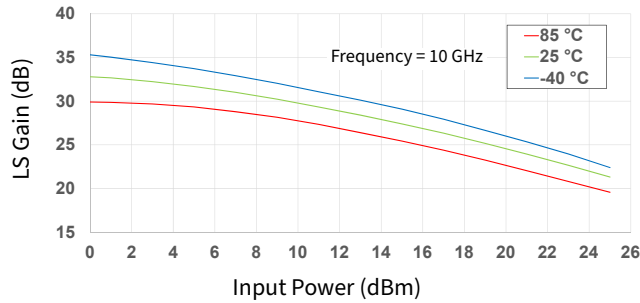

Figure 20. Large Signal Gain vs Input Power as a Function of Temperature

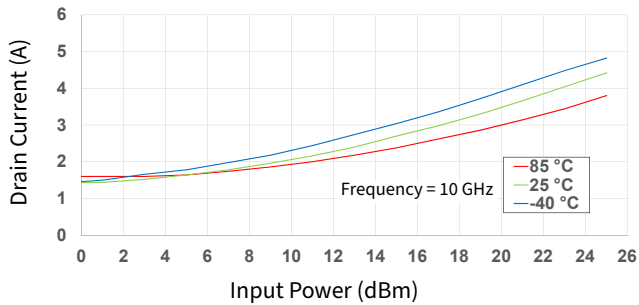

Figure 21. Drain Current vs Input Power as a Function of Temperature

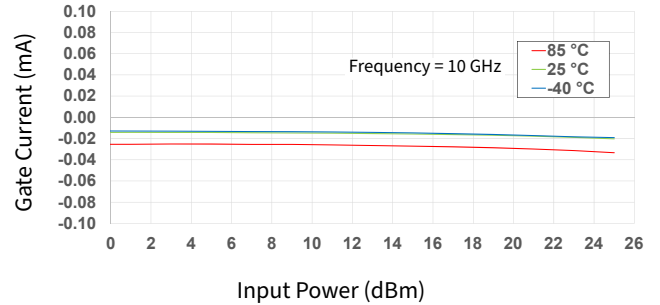

Figure 22. Gate Current vs Input Power as a Function of Temperature

Typical Performance of the CMPA901A035F

Test conditions unless otherwise noted: $V_D = 28\text{ V}$, $I_{DQ} = 1500\text{ mA}$, pulse width = $300\text{ }\mu\text{s}$, duty cycle = 20%, $P_{IN} = 23\text{ dBm}$, $T_{BASE} = +25\text{ }^\circ\text{C}$

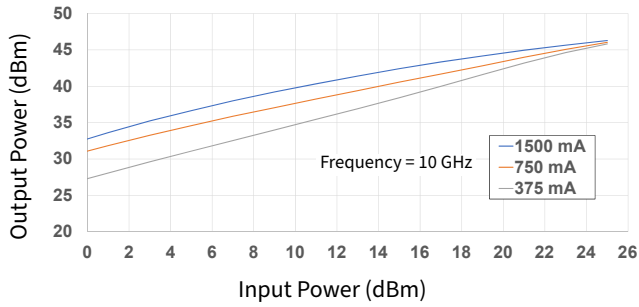

Figure 23. Output Power vs Input Power as a Function of I_{DQ}

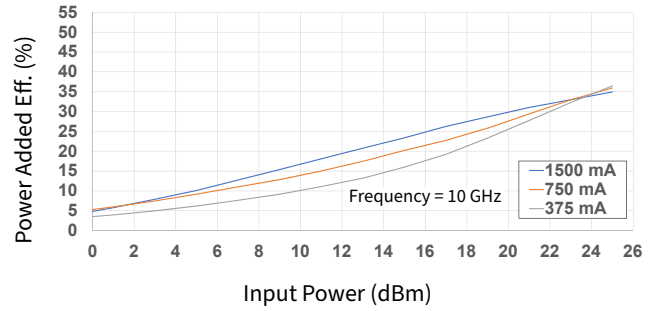

Figure 24. Power Added Eff. vs Input Power as a Function of I_{DQ}

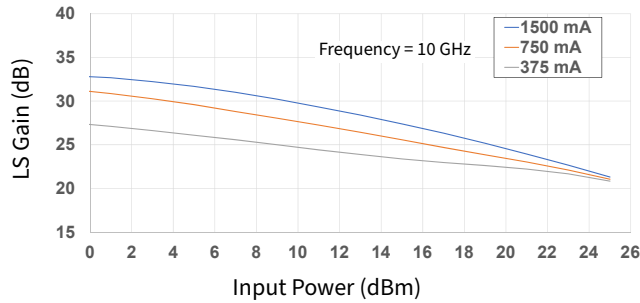

Figure 25. Large Signal Gain vs Input Power as a Function of I_{DQ}

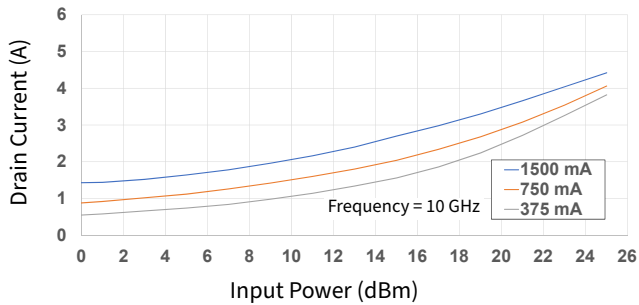

Figure 26. Drain Current vs Input Power as a Function of I_{DQ}

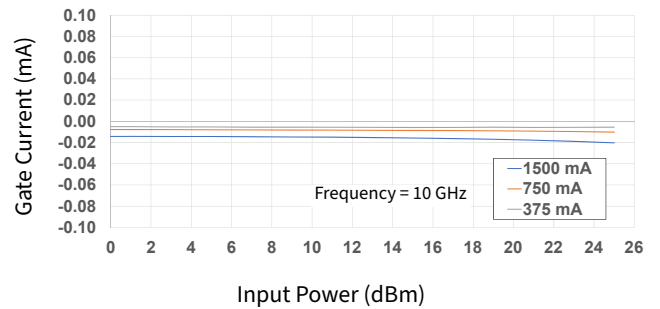

Figure 27. Gate Current vs Input Power as a Function of I_{DQ}

Typical Performance of the CMPA901A035F

Test conditions unless otherwise noted: $V_D = 28\text{ V}$, $I_{DQ} = 1500\text{ mA}$, pulse width = $300\text{ }\mu\text{s}$, duty cycle = 20%, $P_{IN} = 23\text{ dBm}$, $T_{BASE} = +25\text{ }^\circ\text{C}$

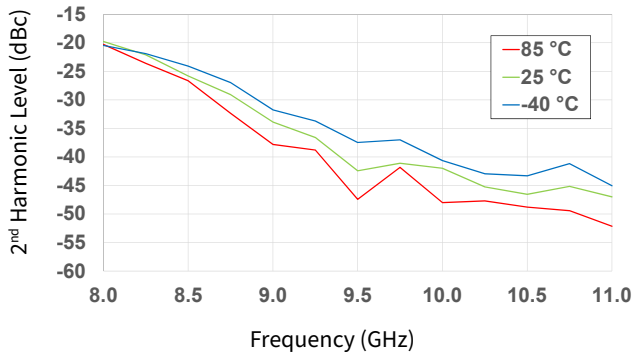

Figure 28. 2nd Harmonic vs Frequency as a Function of Temperature

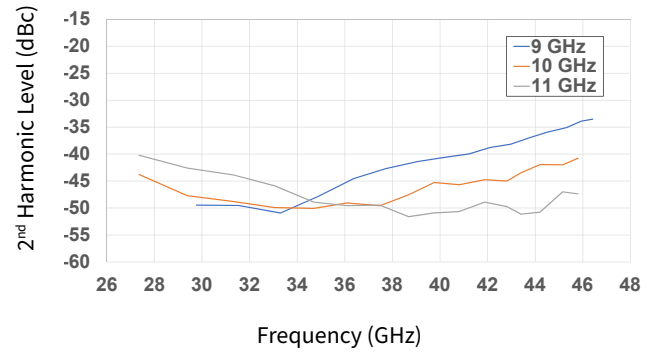

Figure 29. 2nd Harmonic vs Output Power as a Function of Frequency

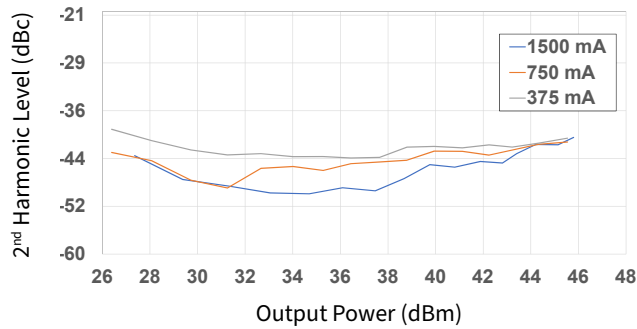

Figure 30. 2nd Harmonic vs Output Power as a Function of I_{DQ}

Typical Performance of the CMPA901A035F

Test conditions unless otherwise noted: $V_D = 28\text{ V}$, $I_{DQ} = 1500\text{ mA}$, $P_{IN} = -20\text{ dBm}$, $T_{BASE} = +25\text{ }^\circ\text{C}$

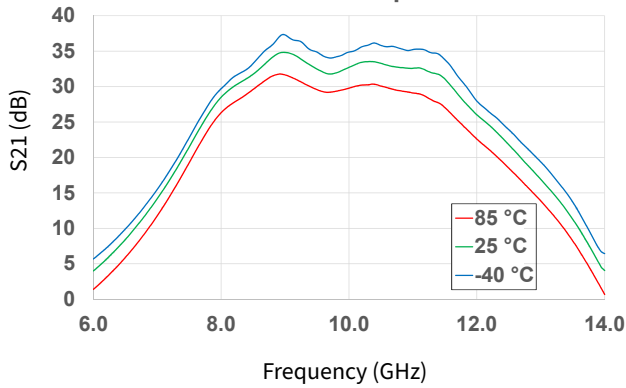

Figure 31. Gain vs Frequency as a Function of Temperature

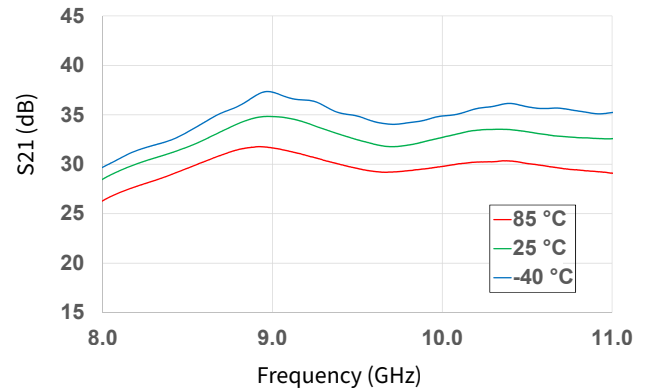

Figure 32. Gain vs Frequency as a Function of Temperature

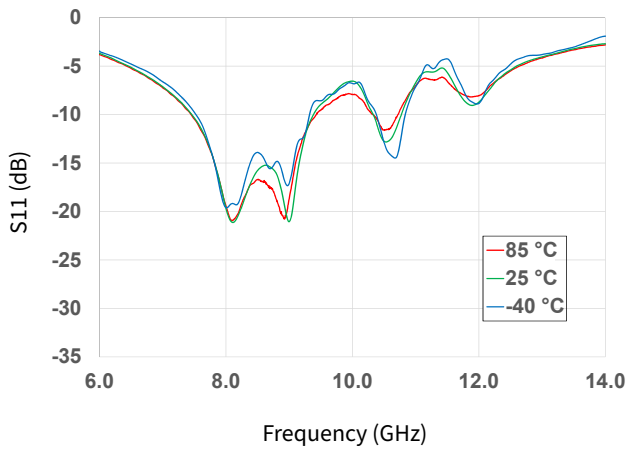

Figure 33. Input RL vs Frequency as a Function of Temperature

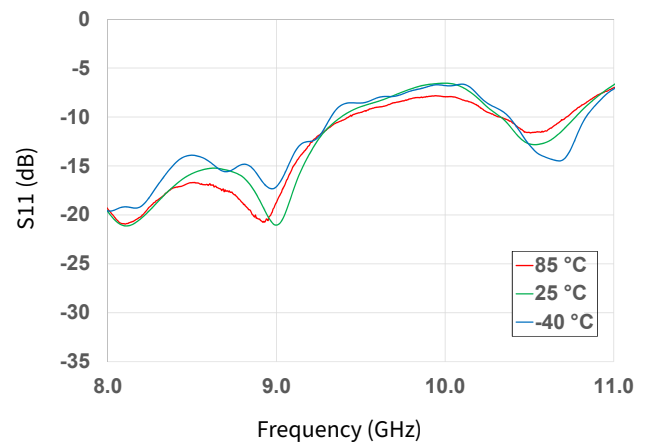

Figure 34. Input RL vs Frequency as a Function of Temperature

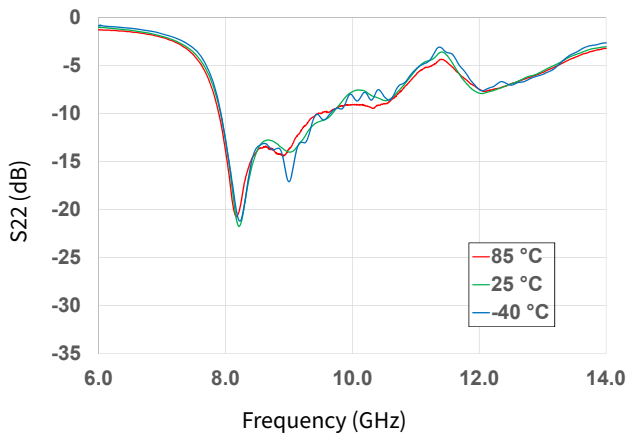

Figure 35. Output RL vs Frequency as a Function of Temperature

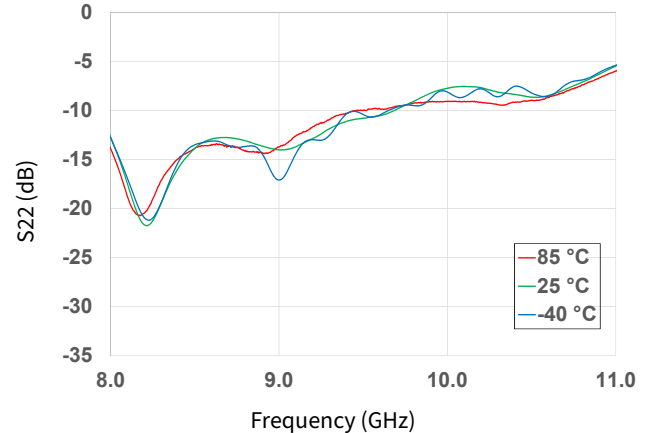

Figure 36. Output RL vs Frequency as a Function of Temperature

Typical Performance of the CMPA901A035F

Test conditions unless otherwise noted: $V_D = 28\text{ V}$, $I_{DQ} = 1500\text{ mA}$, $P_{IN} = -20\text{ dBm}$, $T_{BASE} = +25\text{ }^\circ\text{C}$

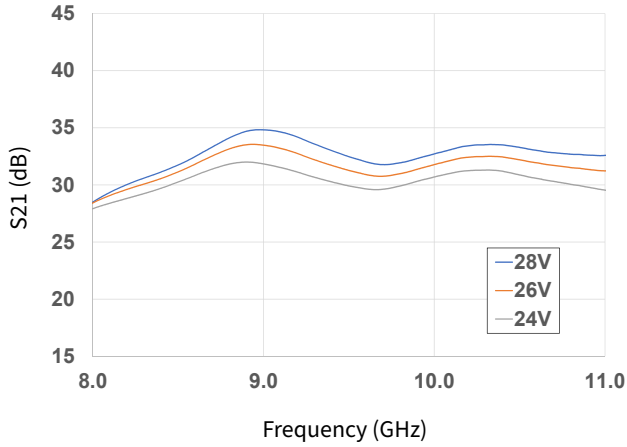

Figure 37. Gain vs Frequency as a Function of Voltage

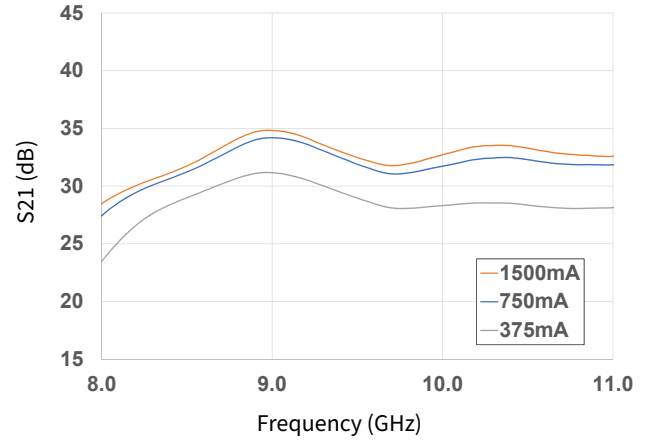

Figure 38. Gain vs Frequency as a Function of I_{DQ}

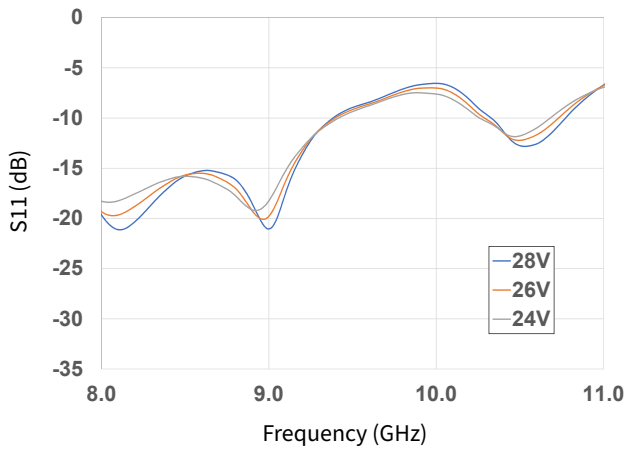

Figure 39. Input RL vs Frequency as a Function of Voltage

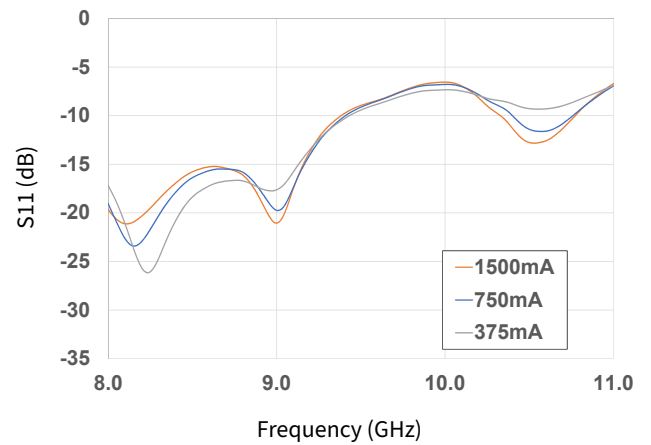

Figure 40. Input RL vs Frequency as a Function of I_{DQ}

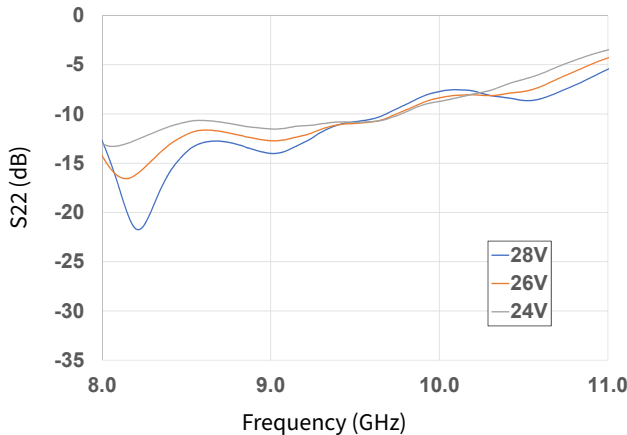

Figure 41. Output RL vs Frequency as a Function of Voltage

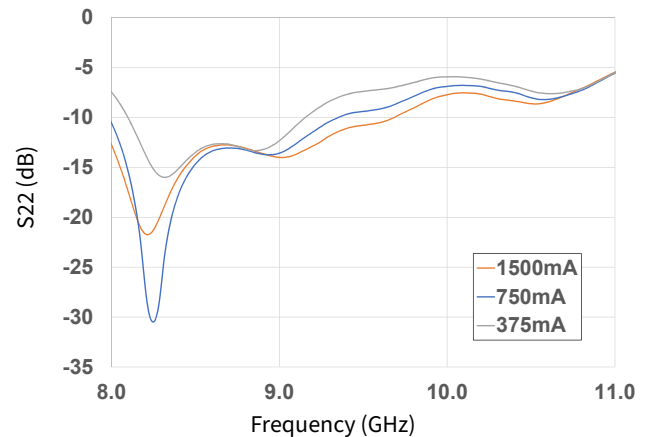

Figure 42. Output RL vs Frequency as a Function of I_{DQ}

Typical Performance of the CPMA901A035F

Test conditions unless otherwise noted: $V_D = 28\text{ V}$, $I_{DQ} = 1500\text{ mA}$, CW, $P_{IN} = 23\text{ dBm}$, $T_{BASE} = +25\text{ }^\circ\text{C}$

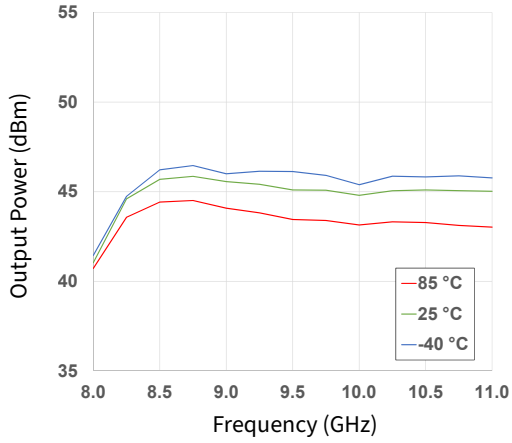

Figure 43. Output Power vs Frequency as a Function of Temperature

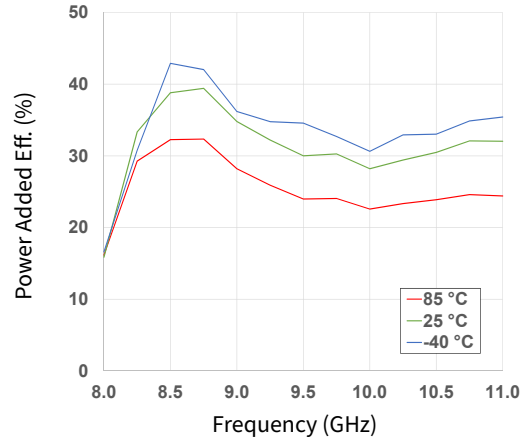

Figure 44. Power Added Eff. vs Frequency as a Function of Temperature

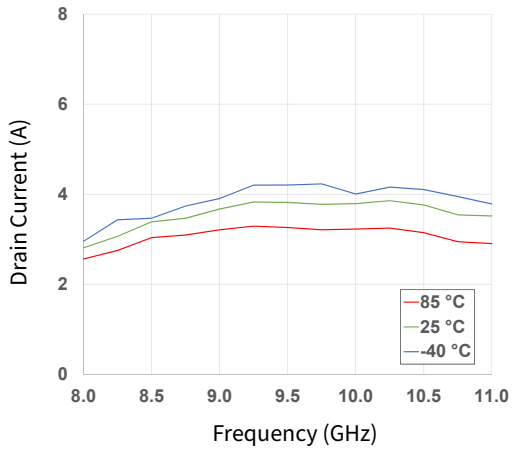

Figure 45. Drain Current vs Frequency as a Function of Temperature

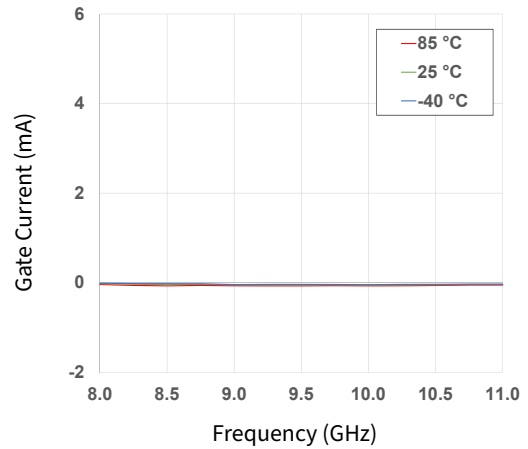

Figure 46. Gate Current vs Frequency as a Function of Temperature

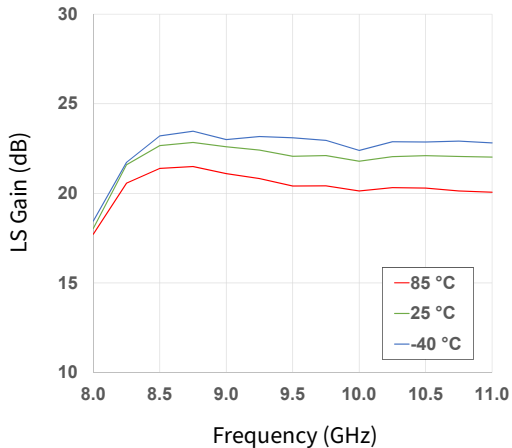

Figure 47. Large Signal Gain vs Frequency as a Function of Temperature

Typical Performance of the CMPA901A035F

Test conditions unless otherwise noted: $V_D = 28\text{ V}$, $I_{DQ} = 1500\text{ mA}$, CW, $P_{IN} = 23\text{ dBm}$, $T_{BASE} = +25\text{ }^\circ\text{C}$

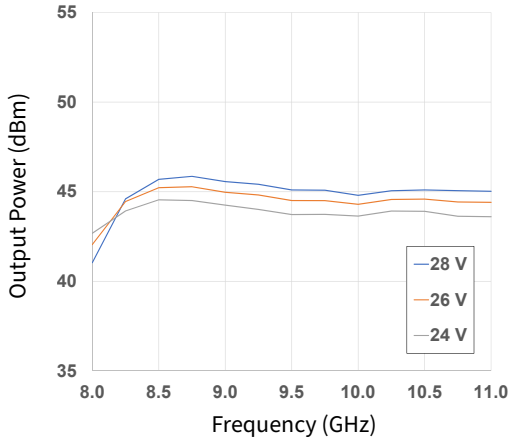

Figure 48. Output Power vs Frequency as a Function of Voltage

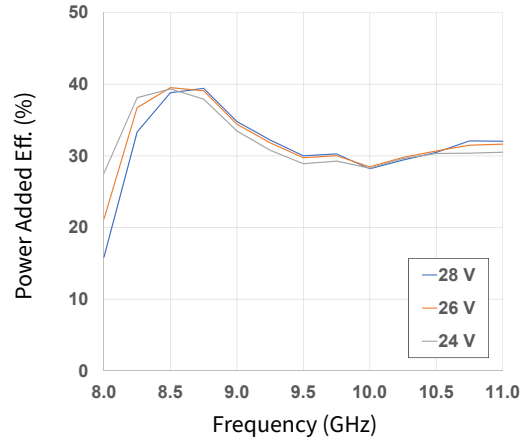

Figure 49. Power Added Eff. vs Frequency as a Function of Voltage

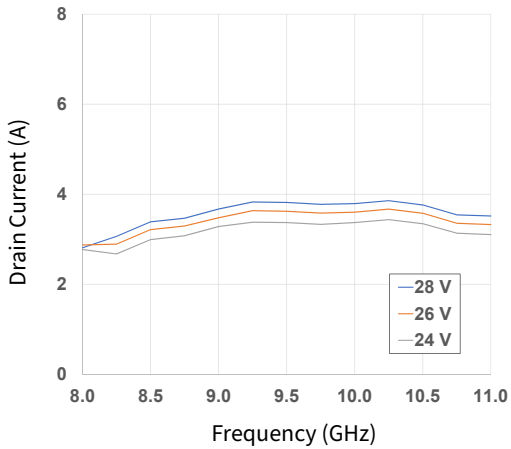

Figure 50. Drain Current vs Frequency as a Function of Voltage

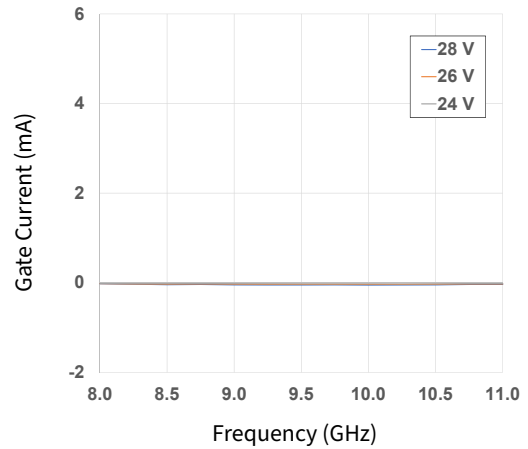

Figure 51. Gate Current vs Frequency as a Function of Voltage

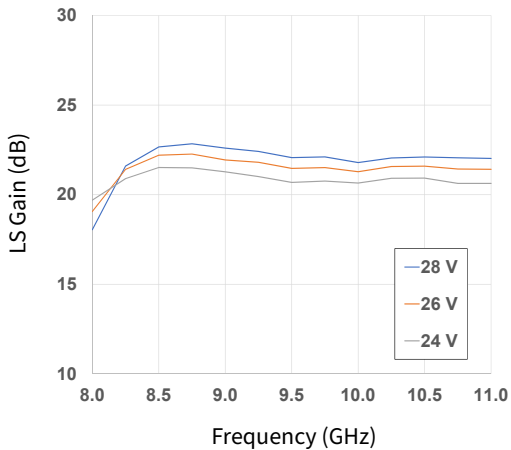

Figure 52. Large Signal Gain vs Frequency as a Function of Voltage

Typical Performance of the CMPA901A035F

Test conditions unless otherwise noted: $V_D = 28\text{ V}$, $I_{DQ} = 1500\text{ mA}$, CW, $P_{IN} = 23\text{ dBm}$, $T_{BASE} = +25\text{ }^\circ\text{C}$

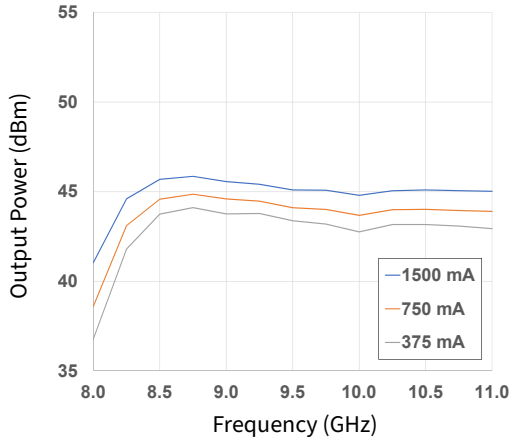

Figure 53. Output Power vs Frequency as a Function of I_{DQ}

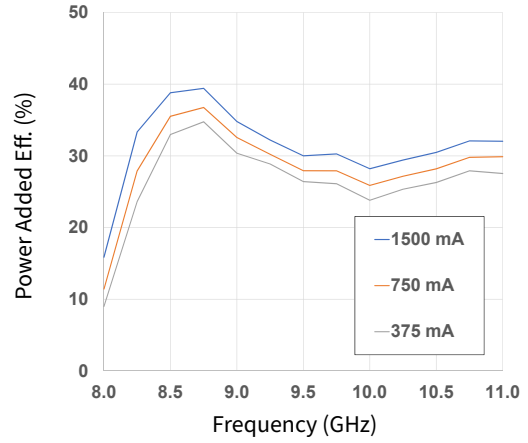

Figure 54. Power Added Eff. vs Frequency as a Function of I_{DQ}

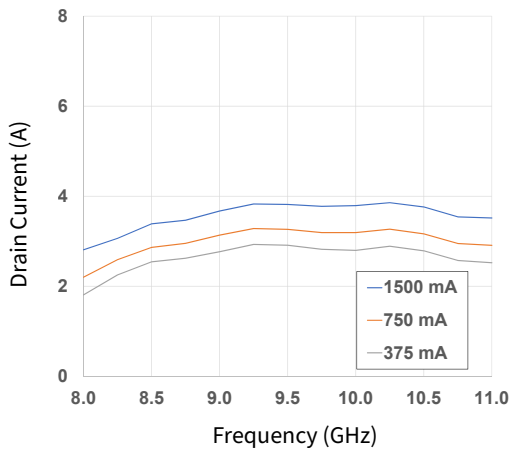

Figure 55. Drain Current vs Frequency as a Function of I_{DQ}

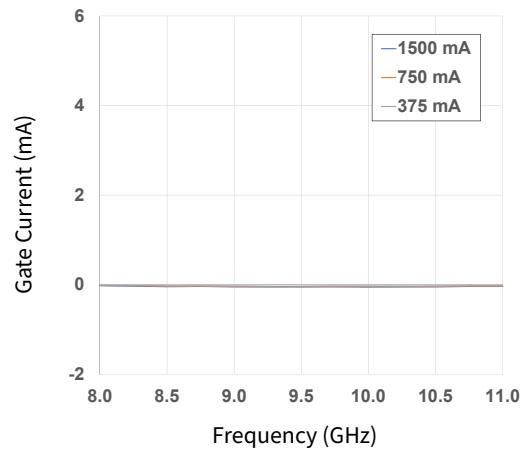

Figure 56. Gate Current vs Frequency as a Function of I_{DQ}

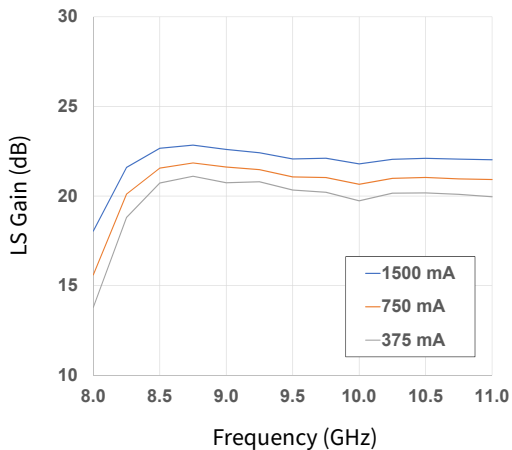

Figure 57. Large Signal Gain vs Frequency as a Function of I_{DQ}

Typical Performance of the CPMA901A035F

Test conditions unless otherwise noted: $V_D = 28\text{ V}$, $I_{DQ} = 1500\text{ mA}$, CW, $P_{IN} = 23\text{ dBm}$, Frequency = 10 GHz, $T_{BASE} = +25\text{ }^\circ\text{C}$

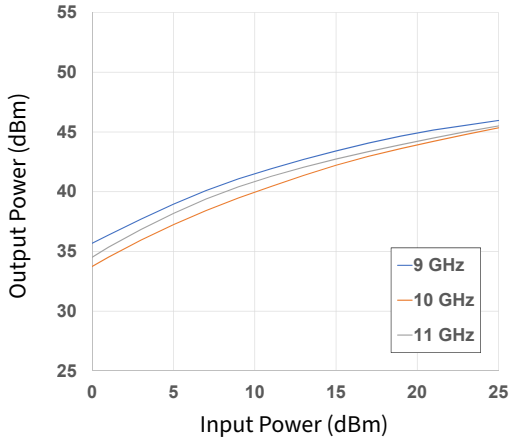

Figure 58. Output Power vs Input Power as a Function of Frequency

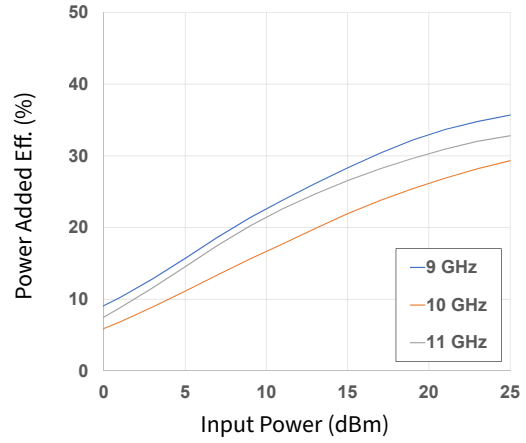

Figure 59. Power Added Eff. vs Input Power as a Function of Frequency

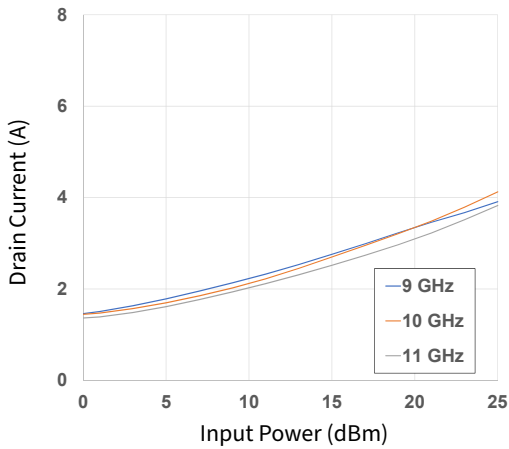

Figure 60. Drain Current vs Input Power as a Function of Frequency

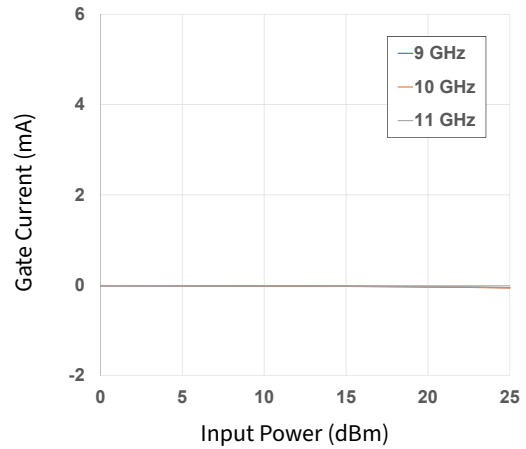

Figure 61. Gate Current vs Input Power as a Function of Frequency

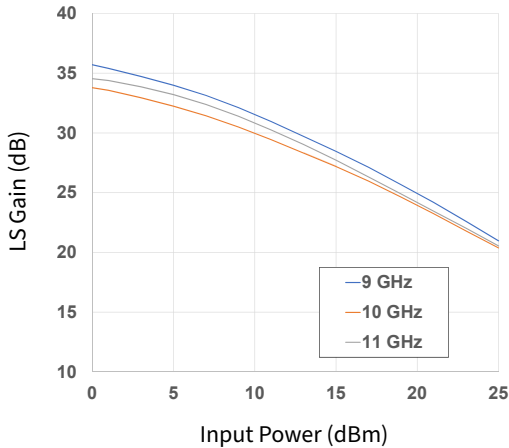

Figure 62. Large Signal Gain vs Input Power as a Function of Frequency

Typical Performance of the CMPA901A035F

Test conditions unless otherwise noted: $V_D = 28\text{ V}$, $I_{DQ} = 1500\text{ mA}$, CW, $P_{IN} = 23\text{ dBm}$, Frequency = 10 GHz, $T_{BASE} = +25\text{ }^\circ\text{C}$

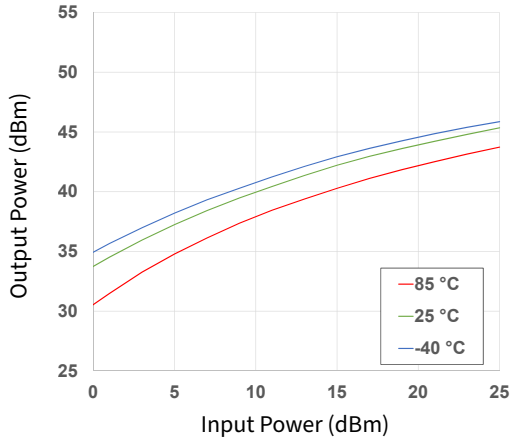

Figure 63. Output Power vs Input Power as a Function of Temperature

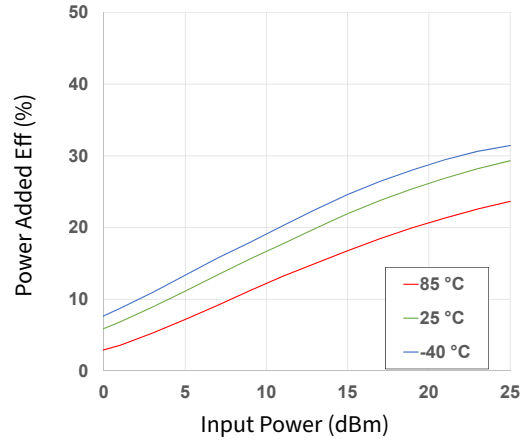

Figure 64. Power Added Eff. vs Input Power as a Function of Temperature

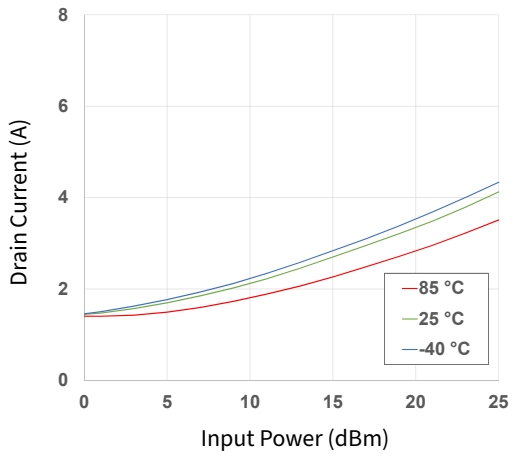

Figure 65. Drain Current vs Input Power as a Function of Temperature

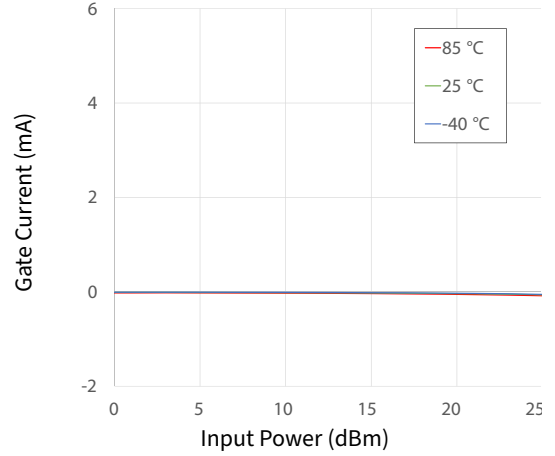

Figure 66. Gate Current vs Input Power as a Function of Temperature

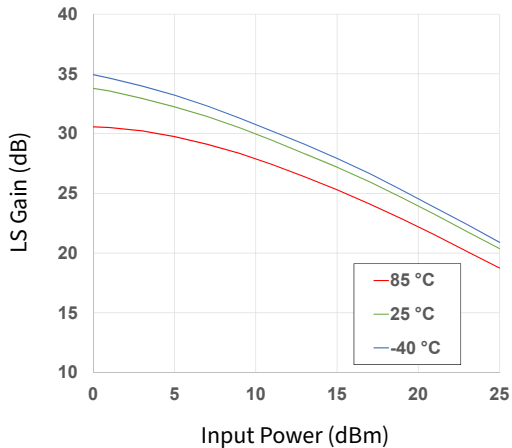

Figure 67. Large Signal Gain vs Input Power as a Function of Temperature

Typical Performance of the CMPA901A035F

Test conditions unless otherwise noted: $V_D = 28\text{ V}$, $I_{DQ} = 1500\text{ mA}$, CW, $P_{IN} = 23\text{ dBm}$, Frequency = 10 GHz, $T_{BASE} = +25\text{ }^\circ\text{C}$

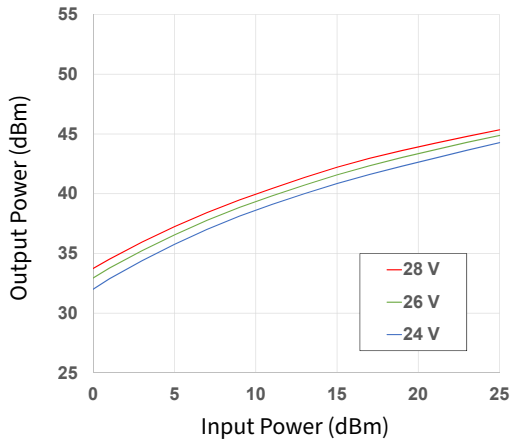

Figure 68. Output Power vs Input Power as a Function of Voltage

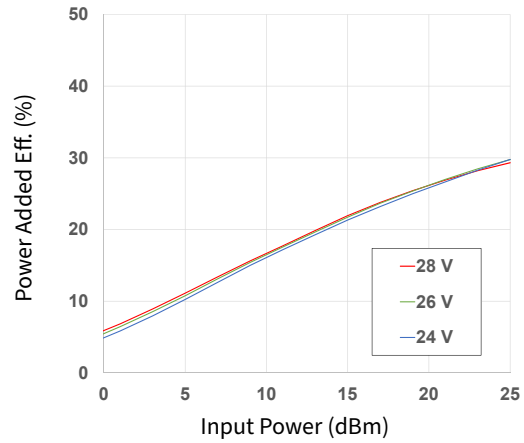

Figure 69. Power Added Eff. vs Input Power as a Function of Voltage

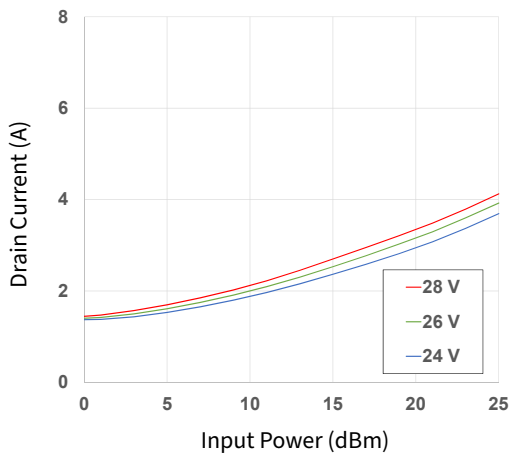

Figure 70. Drain Current vs Input Power as a Function of Voltage

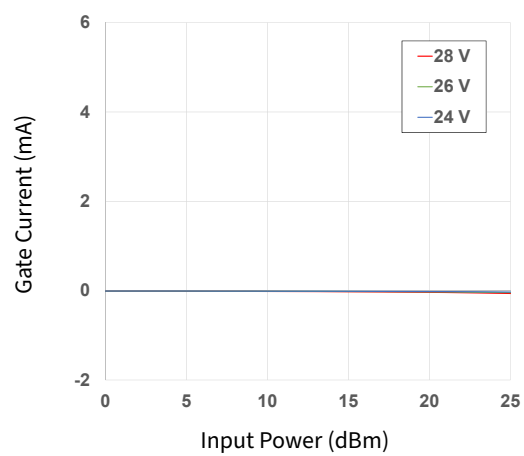

Figure 71. Gate Current vs Input Power as a Function of Voltage

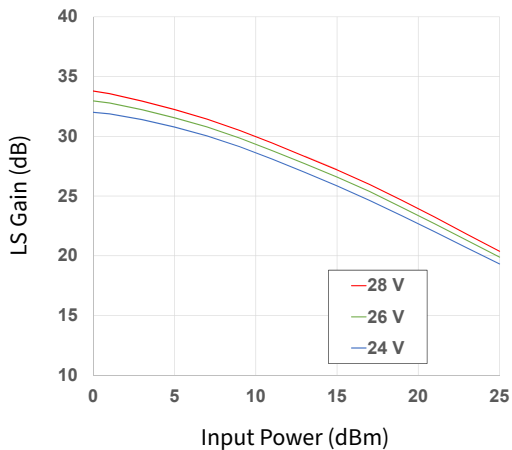

Figure 72. Large Signal Gain vs Input Power as a Function of Voltage

Typical Performance of the CMPA901A035F

Test conditions unless otherwise noted: $V_D = 28\text{ V}$, $I_{DQ} = 1500\text{ mA}$, CW, $P_{IN} = 23\text{ dBm}$, $T_{BASE} = +25\text{ }^\circ\text{C}$

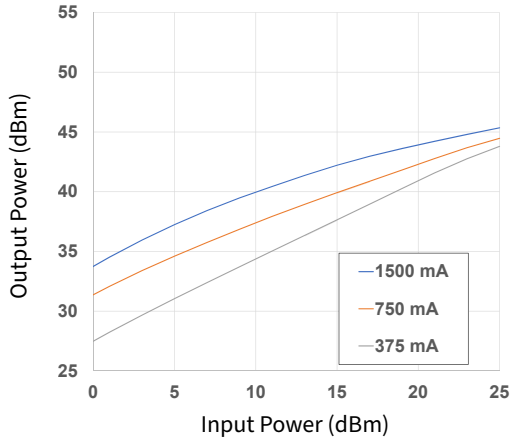

Figure 73. Output Power vs Input Power as a Function of I_{DQ}

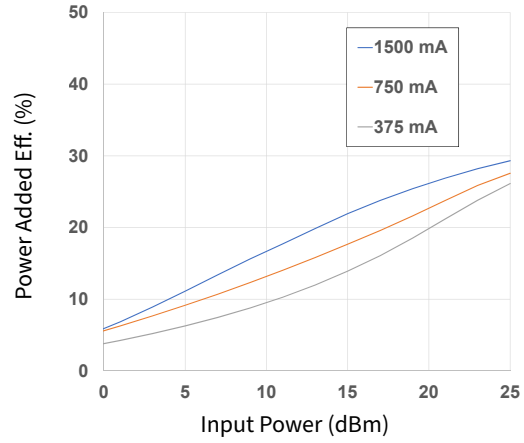

Figure 74. Power Added Eff. vs Input Power as a Function of I_{DQ}

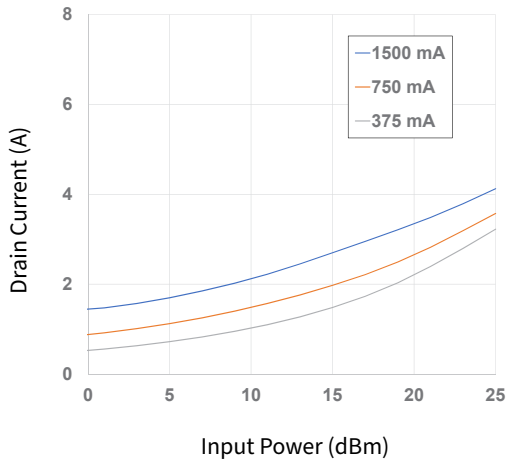

Figure 75. Drain Current vs Input Power as a Function of I_{DQ}

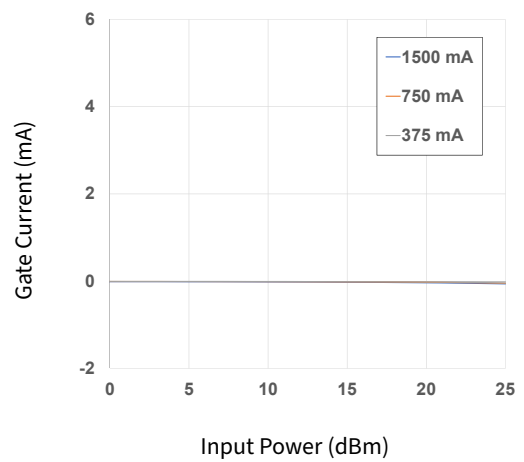

Figure 76. Gate Current vs Input Power as a Function of I_{DQ}

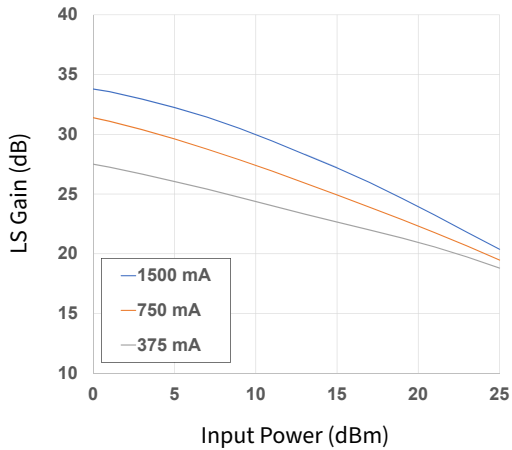
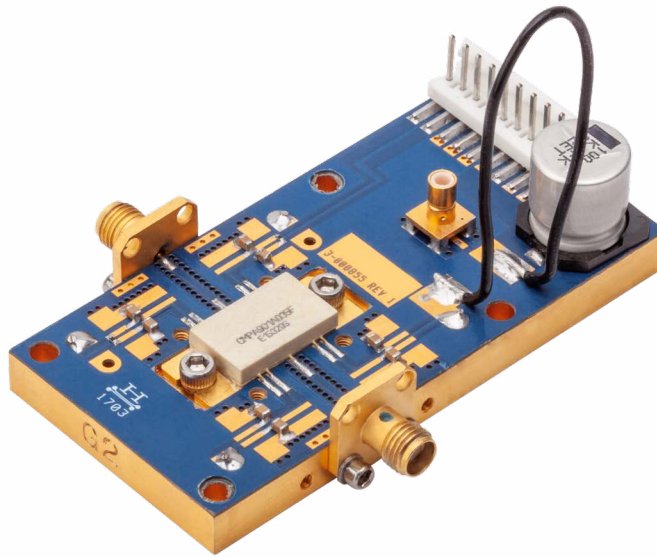

Figure 77. Large Signal Gain vs Input Power as a Function of I_{DQ}

CMPA901A035F-AMP Evaluation Board Bill of Materials

Designator	Description	Qty
C15	CAP ELECT 100 UF 80 V AFK SMD	1
C16 - C23	CAP, 33000 PF, 0805, 100 V, X7R	8
R1, R2	RES 0.0 OHM 1/16 W 0402 SMD	2
J1, J2	CONN, SMA, PANEL MOUNT JACK, FLANGE, 4-HOLE, BLUNT POST, 20MIL	2
J4	CONN, SMB, STRAIGHT JACK RECEPTACLE, SMT, 50 OHM, Au PLATED	1
J3	HEADER RT>PLZ .1CEN LK 9POS	1
W1	WIRE, BLACK, 22 AWG ~ 1.50"	1
W2	WIRE, BLACK, 22 AWG ~ 1.75"	1
W3	WIRE, BLACK, 22 AWG ~ 3.0"	1
Q1	CMPA901A035F	1

CMPA901A035F-AMP Evaluation Board Circuit



CMPA901A035F-AMP Evaluation Board Schematic

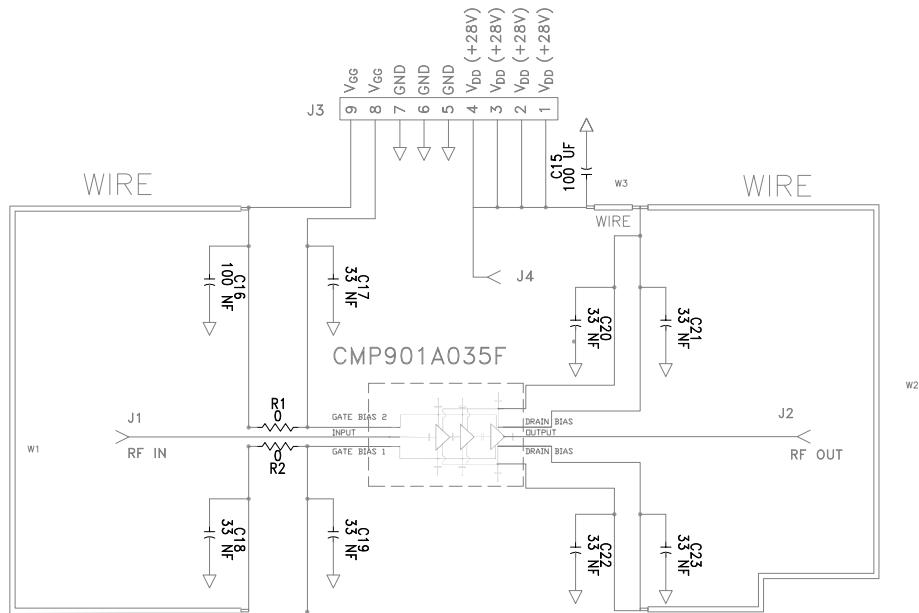

CMPA901A035F-AMP Evaluation Board Outline

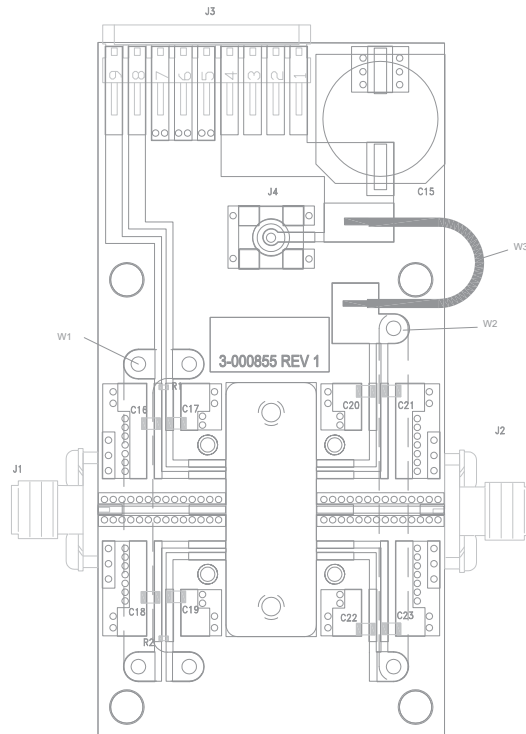

Product Dimensions CMPA901A035F

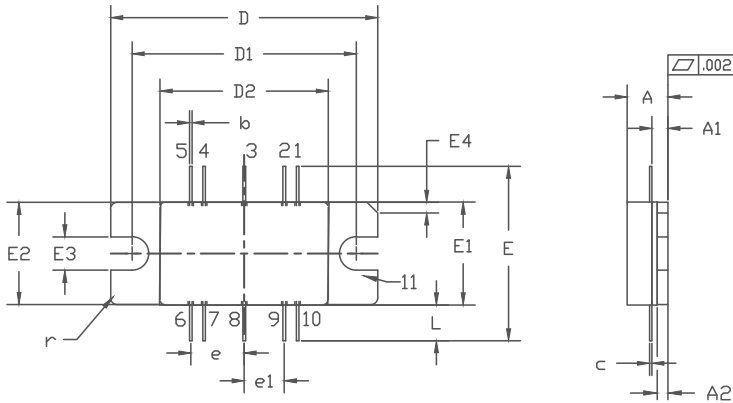

PIN 1: GATE BIAS 6: DRAIN BIAS
 2: GATE BIAS 7: DRAIN BIAS
 3: RF IN 8: RF OUT
 4: GATE BIAS 9: DRAIN BIAS
 5: GATE BIAS 10: DRAIN BIAS
 11: SOURCE

NOTES:

1. DIMENSIONING AND TOLERANCING PER ANSI Y14.5M - 1994.
2. CONTROLLING DIMENSION: INCH.
3. ADHESIVE FROM LID MAY EXTEND A MAXIMUM OF 0.020" BEYOND EDGE OF LID.
4. LID MAY BE MISALIGNED TO THE BODY OF PACKAGE BY A MAXIMUM OF 0.008" IN ANY DIRECTION.

DIM	INCHES		MILLIMETERS		NOTES
	MIN	MAX	MIN	MAX	
A	0.148	0.168	3.76	4.27	
A1	0.055	0.065	1.40	1.65	
A2	0.035	0.045	0.89	1.14	
b	0.01	TYP	0.254	TYP	10x
c	0.007	0.009	0.18	0.23	
D	0.995	1.005	25.27	25.53	
D1	0.835	0.845	21.21	21.46	
D2	0.623	0.637	15.82	16.18	
E	0.653	TYP	16.59	TYP	
E1	0.380	0.390	9.65	9.91	
E2	0.380	0.390	9.65	9.91	
E3	0.120	0.130	3.05	3.30	
E4	0.035	0.045	0.89	1.14	45° CHAMFER
e	0.200	TYP	5.08	TYP	4x
e1	0.150	TYP	3.81	TYP	4x
L	0.115	0.155	2.92	3.94	10x
r	0.025	TYP	.635	TYP	3x

Pin Number	Qty
1	Gate Bias for Stage 1, 2 & 3
2	Gate Bias for Stage 1, 2 & 3
3	RF IN
4	Gate Bias for Stage 1, 2 & 3
5	Gate Bias for Stage 1, 2 & 3
6	Drain Bias
7	Drain Bias
8	RF OUT
9	Drain Bias
10	Drain Bias

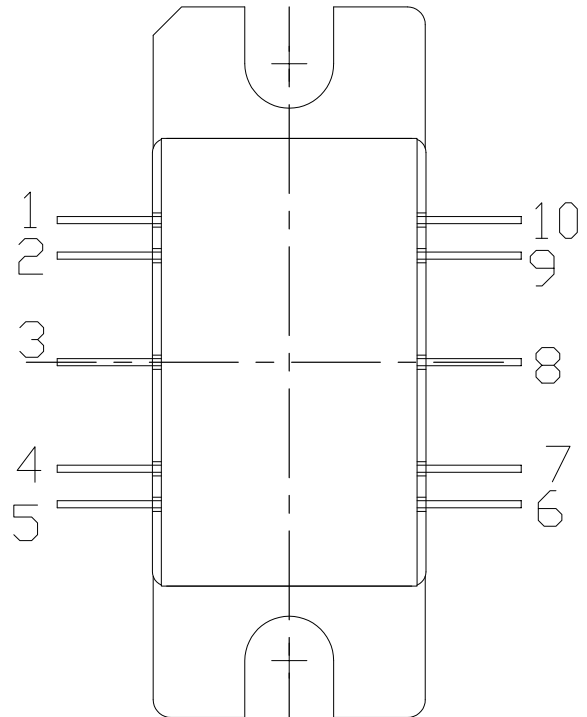

Part Number System

CMPA901A035F

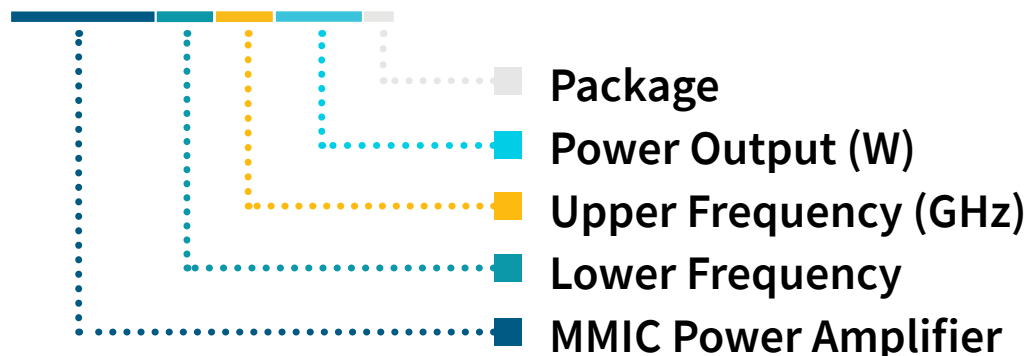

Table 1.

Parameter	Value	Units
Lower Frequency	9.0	GHz
Upper Frequency ¹	10.0	GHz
Power Output	35	W
Package	Flanged	-



Note:

¹Alpha characters used in frequency code indicate a value greater than 9.9 GHz. See Table 2 for value.

Table 2.

Character Code	Code Value
A	0
B	1
C	2
D	3
E	4
F	5
G	6
H	7
J	8
K	9
Examples:	1 A = 10.0 GHz 2 H = 27.0 GHz

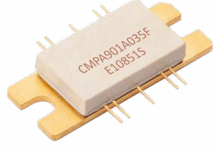
Product Ordering Information

Order Number	Description	Unit of Measure	Image
CMPA901A035F	GaN HEMT	Each	
CMPA901A035F-AMP	Test Board with GaN MMIC Installed	Each	

Notes & Disclaimer

MACOM Technology Solutions Inc. ("MACOM"). All rights reserved.

These materials are provided in connection with MACOM's products as a service to its customers and may be used for informational purposes only. Except as provided in its Terms and Conditions of Sale or any separate agreement, MACOM assumes no liability or responsibility whatsoever, including for (i) errors or omissions in these materials; (ii) failure to update these materials; or (iii) conflicts or incompatibilities arising from future changes to specifications and product descriptions, which MACOM may make at any time, without notice. These materials grant no license, express or implied, to any intellectual property rights.

THESE MATERIALS ARE PROVIDED "AS IS" WITH NO WARRANTY OR LIABILITY, EXPRESS OR IMPLIED, RELATING TO SALE AND/OR USE OF MACOM PRODUCTS INCLUDING FITNESS FOR A PARTICULAR PURPOSE, MERCHANTABILITY, INFRINGEMENT OF INTELLECTUAL PROPERTY RIGHT, ACCURACY OR COMPLETENESS, OR SPECIAL, INDIRECT, INCIDENTAL, OR CONSEQUENTIAL DAMAGES WHICH MAY RESULT FROM USE OF THESE MATERIALS.

MACOM products are not intended for use in medical, lifesaving or life sustaining applications. MACOM customers using or selling MACOM products for use in such applications do so at their own risk and agree to fully indemnify MACOM for any damages resulting from such improper use or sale.

Mouser Electronics

Authorized Distributor

Click to View Pricing, Inventory, Delivery & Lifecycle Information:

[MACOM:](#)

[CMPA901A035F-AMP](#) [CMPA901A035F](#)