

LSIC1MO120G0040
1200 V, 40 mOhm N-Channel SiC MOSFET

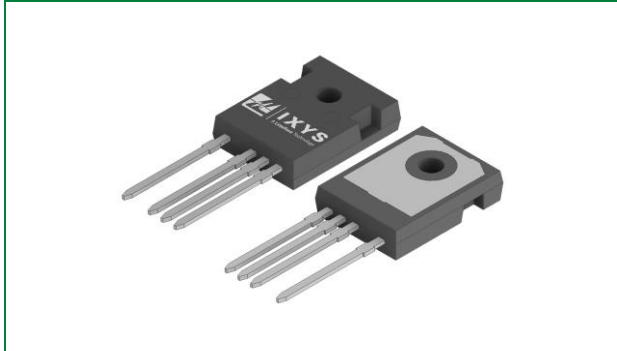

Agency Approvals and Environmental

Environmental Approvals



Pinout Diagram

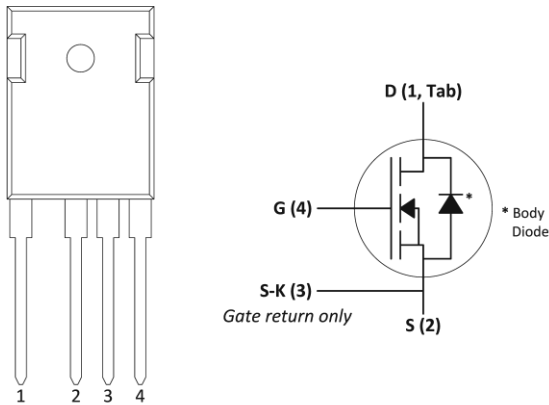

Product Summary

Characteristic	Value	Unit
V_{DS}	1200	V
Typical $R_{DS(ON)}$	40	mOhm
I_D ($T_C \leq 100\text{ }^\circ\text{C}$)	50	A

Features

- Optimized for high-frequency, high-efficiency applications
- Extremely low gate charge and output capacitance
- Low gate resistance for high-frequency switching
- Normally-off operations at all temperatures
- Ultra-low on-resistance
- Optimized package with separate driver source pin
- RoHS compliant, lead-free, and halogen-free

Applications

- High-frequency applications
- Solar Inverters
- Switch Mode Power Supplies
- UPS
- Motor Drives
- High Voltage DC/DC Converters
- Battery Chargers
- Induction Heating

- 1. Maximum Ratings.....3
- 2. Thermal Characteristics3
- 3. Electrical Characteristics3
 - 3.1. Static Characteristics ($T_J = 25\text{ }^\circ\text{C}$ unless otherwise specified)3
 - 3.2. Dynamic Characteristics ($T_J = 25\text{ }^\circ\text{C}$ unless otherwise specified)4
- 4. Reverse Diode Characteristics ($T_J = 25\text{ }^\circ\text{C}$ unless otherwise specified)4
- 5. Performance Curves5
- 6. Package Dimensions9
- 7. Part Numbering and Marking.....9
- 8. Packing Options9
- 9. Packing Specifications10

1. Maximum Ratings

Characteristic	Symbol	Conditions	Value	Unit
Drain-Source Voltage	V_{DS}	$V_{GS} = 0\text{ V}$	1200	V
Continuous Drain Current	I_D	$V_{GS} = 20\text{ V}, T_C = 25\text{ }^\circ\text{C}$	70	A
		$V_{GS} = 20\text{ V}, T_C = 100\text{ }^\circ\text{C}$	50	
Pulsed Drain Current ¹	$I_{D(pulse)}$	$T_C = 25\text{ }^\circ\text{C}$	130	A
Power Dissipation	P_D	$T_C = 25\text{ }^\circ\text{C}, T_J = 175\text{ }^\circ\text{C}$	357	W
Gate-Source Voltage	$V_{GS,MAX}$	Absolute maximum values – Steady state	-6 to +22	V
	$V_{GS,OP,TR}$ ²	Transient, $t_{transient} < 300\text{ nsec}$	-10 to +25	
	$V_{GS,OP}$ ³	Recommended DC operating values	-5 to +20	
Operating Junction Temperature	T_J	-	-55 to +175	$^\circ\text{C}$
Storage Temperature	T_{STG}	-	-55 to +150	$^\circ\text{C}$
Lead Temperature for Soldering	T_{sold}	-	260	$^\circ\text{C}$
Mounting Torque	M_D	M3 or 6-32 screw	1.0	Nm
			8.8	in-lb

Footnote 1: Pulse width limited by $T_{J,MAX}$

Footnote 2: See Figure 21. V_{GS} Waveform Definition for further information

Footnote 3: MOSFET can operate with $V_{GS(OFF)} = 0\text{ V}$. $V_{GS(OFF)} = -5\text{ V}$ provides added noise margin and faster turn-off speed

2. Thermal Characteristics

Characteristic	Symbol	Value	Unit
Maximum Thermal Resistance, junction-to-case	$R_{th,JC,MAX}$	0.42	$^\circ\text{C/W}$
Maximum Thermal Resistance, junction-to-ambient	$R_{th,JA,MAX}$	40	$^\circ\text{C/W}$

3. Electrical Characteristics

3.1. Static Characteristics ($T_J = 25\text{ }^\circ\text{C}$ unless otherwise specified)

Characteristic	Symbol	Conditions	Value			Unit
			Min	Typ	Max	
Drain-Source Breakdown Voltage	$V_{(BR)DSS}$	$V_{GS} = 0\text{ V}, I_D = 100\text{ }\mu\text{A}$	1200	-	-	V
Zero Gate Voltage Drain Current	I_{DSS}	$V_{DS} = 1200\text{ V}, V_{GS} = 0\text{ V}$	-	<1	100	μA
		$V_{DS} = 1200\text{ V}, V_{GS} = 0\text{ V}, T_J = 175\text{ }^\circ\text{C}$	-	<1	-	
Gate Leakage Current	$I_{GSS,F}$	$V_{GS} = 22\text{ V}, V_{DS} = 0\text{ V}$	-	-	100	nA
	$I_{GSS,R}$	$V_{GS} = -6\text{ V}, V_{DS} = 0\text{ V}$	-	-	100	
Drain-Source On-State Resistance	$R_{DS(ON)}$	$I_D = 40\text{ A}, V_{GS} = 20\text{ V}$	-	40	50	m Ω
		$I_D = 40\text{ A}, V_{GS} = 20\text{ V}, T_J = 175\text{ }^\circ\text{C}$	-	65	-	
Gate Threshold Voltage	$V_{GS(TH)}$	$V_{DS} = V_{GS}, I_D = 20\text{ mA}$	1.8	2.7	4	V
		$V_{DS} = V_{GS}, I_D = 20\text{ mA}, T_J = 175\text{ }^\circ\text{C}$	-	1.7	-	
Gate Resistance	R_G	Resonance method, Drain-Source shorted ¹	-	0.8	-	Ω

Footnote 1: For a description of the resonance method for measuring R_G , refer to the JEDEC Standard JESD24-11 test method

3.2. Dynamic Characteristics ($T_J = 25\text{ }^\circ\text{C}$ unless otherwise specified)

Characteristic	Symbol	Conditions	Value			Unit
			Min	Typ	Max	
Turn-On Switching Energy	E_{ON}	$V_{DD} = 800\text{ V}$, $I_D = 40\text{ A}$, $V_{GS} = -5 / +20\text{ V}$, $R_{G,ext} = 2.5\ \Omega$, $L = 350\ \mu\text{H}$, $FWD = \text{LSIC2SD120A20}$	-	380	-	μJ
Turn-Off Switching Energy	E_{OFF}		-	92	-	
Total Per-Cycle Switching Energy	E_{TS}		-	472	-	
Input Capacitance	C_{ISS}	$V_{DD} = 800\text{ V}$, $V_{GS} = 0\text{ V}$, $f = 1\text{ MHz}$, $V_{AC} = 25\text{ mV}$	-	3170	-	pF
Output Capacitance	C_{OSS}		-	140	-	
Reverse Transfer Capacitance	C_{RSS}		-	13	-	
COSS Stored Energy	E_{OSS}		-	45	-	
Total Gate Charge	Q_g	$V_{DD} = 800\text{ V}$, $I_D = 40\text{ A}$, $V_{GS} = -5 / +20\text{ V}$	-	175	-	nC
Gate-Source Charge	Q_{gs}		-	53	-	
Gate-Drain Charge	Q_{gd}		-	58	-	
Turn-On Delay Time	$t_{d(on)}$	$V_{DD} = 800\text{ V}$, $I_D = 40\text{ A}$, $V_{GS} = -5 / +20\text{ V}$, $R_{G,ext} = 2\ \Omega$, $R_L = 20\ \Omega$, Timing relative to V_{DS}	-	13	-	ns
Rise Time	t_r		-	9	-	
Turn-Off Delay Time	$t_{d(off)}$		-	22	-	
Fall Time	t_f		-	8	-	

4. Reverse Diode Characteristics ($T_J = 25\text{ }^\circ\text{C}$ unless otherwise specified)

Characteristic	Symbol	Conditions	Value			Unit
			Min	Typ	Max	
Diode Forward Voltage	V_{SD}	$I_S = 20\text{ A}$, $V_{GS} = -5\text{ V}$	-	4.3	-	V
		$I_S = 20\text{ A}$, $V_{GS} = -5\text{ V}$, $T_J = 175\text{ }^\circ\text{C}$	-	3.8	-	
Continuous Diode Forward Current	I_S	$V_{GS} = -5\text{ V}$, $T_C = 25\text{ }^\circ\text{C}$	-	-	60	A
Peak Diode Forward Current ¹	I_{SP}		-	-	130	
Reverse Recovery Time	t_{rr}	$V_{GS} = -5\text{ V}$, $I_S = 40\text{ A}$, $V_R = 800\text{ V}$, $di/dt = 8.4\text{ A/ns}$	-	13	-	ns
Reverse Recovery Charge	Q_{rr}		-	403	-	nC
Peak Reverse Recovery Current	I_{rrm}		-	51	-	A

Footnote 1: Pulse width limited by $T_{J,MAX}$

5. Performance Curves

Figure 1. Maximum Power Dissipation ($T_J = 175\text{ }^\circ\text{C}$)

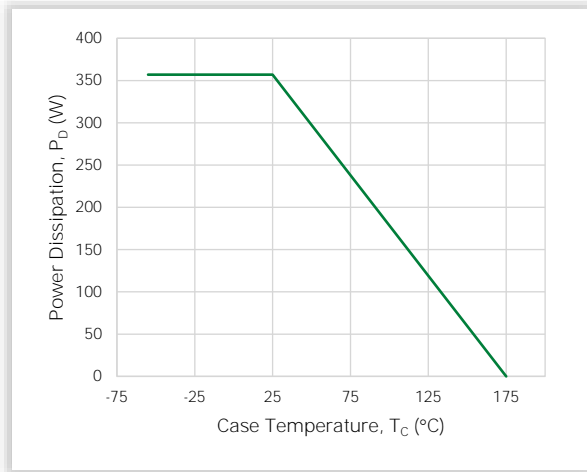

Figure 2. Typical Transfer Characteristics

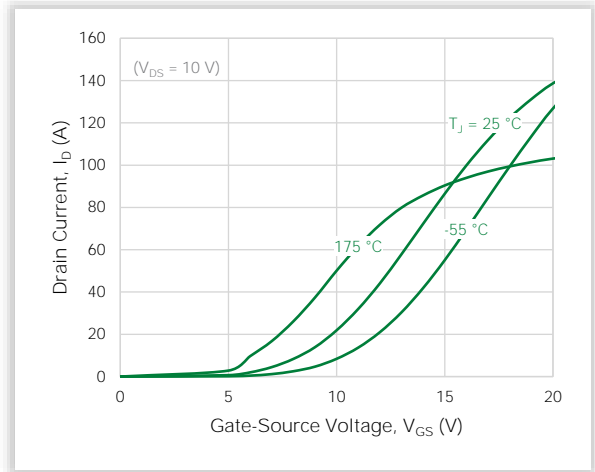

Figure 3. Typical Output Characteristics ($T_J = 25\text{ }^\circ\text{C}$)

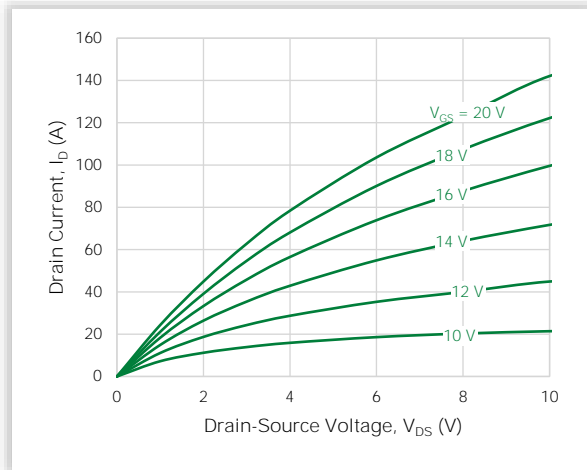

Figure 4. Typical Output Characteristics ($T_J = 175\text{ }^\circ\text{C}$)

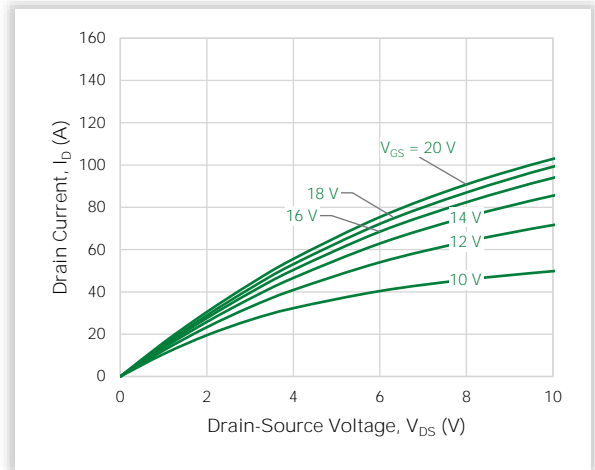

Figure 5. Typical Output Characteristics ($T_J = -55\text{ }^\circ\text{C}$)

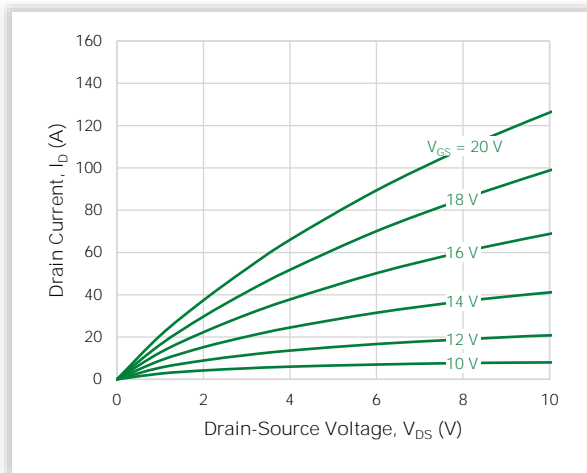

Figure 6. Typical Reverse Conduction Characteristics ($T_J = 25\text{ }^\circ\text{C}$)

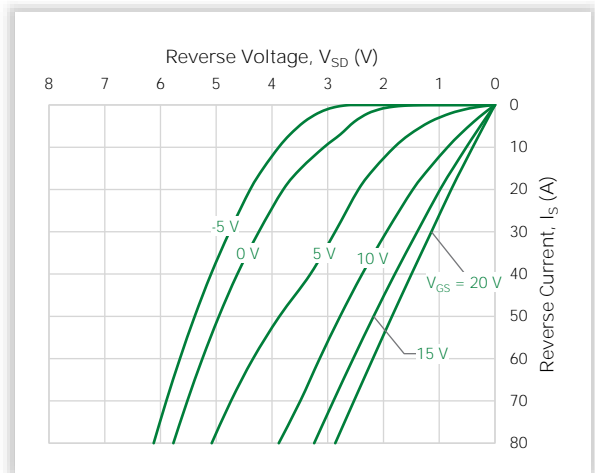

Figure 7. Typical Reverse Conduction Characteristics ($T_J = 175\text{ }^\circ\text{C}$)

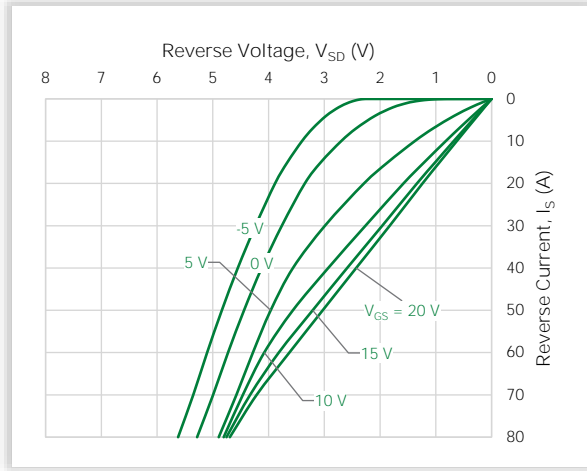

Figure 8. Typical Reverse Conduction Characteristics ($T_J = -55\text{ }^\circ\text{C}$)

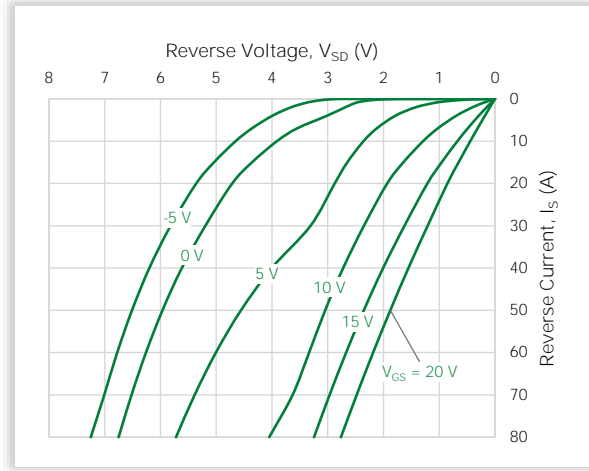

Figure 9. Transient Thermal Impedance

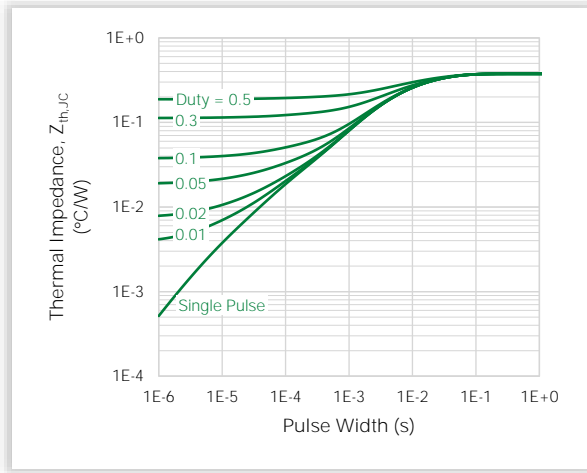

Figure 10. Maximum Safe Operating Area ($T_C = 25\text{ }^\circ\text{C}$)

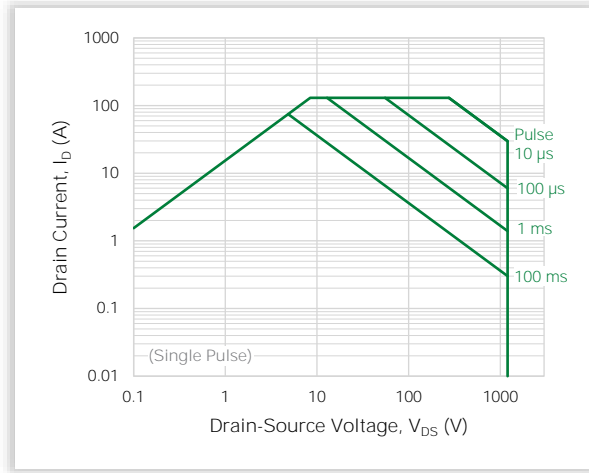

Figure 11. On-resistance vs. Drain Current

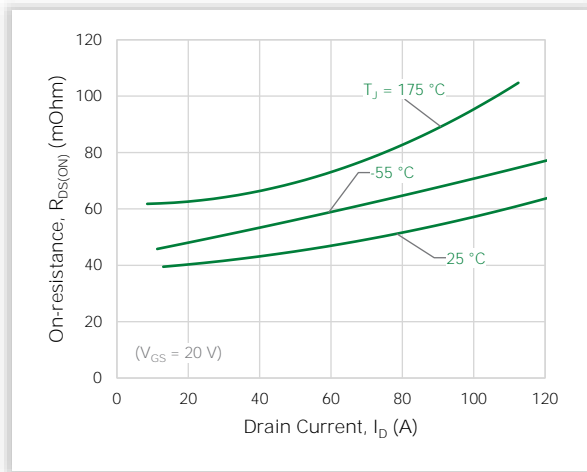

Figure 12. Normalized On-resistance vs. Junction Temperature

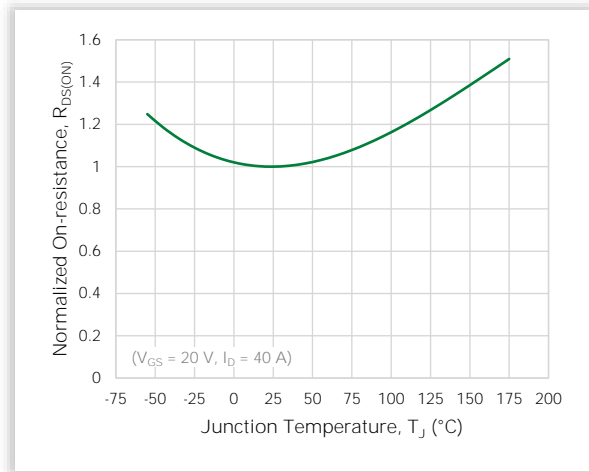

Figure 13. Typical On-resistance vs. Junction Temperature

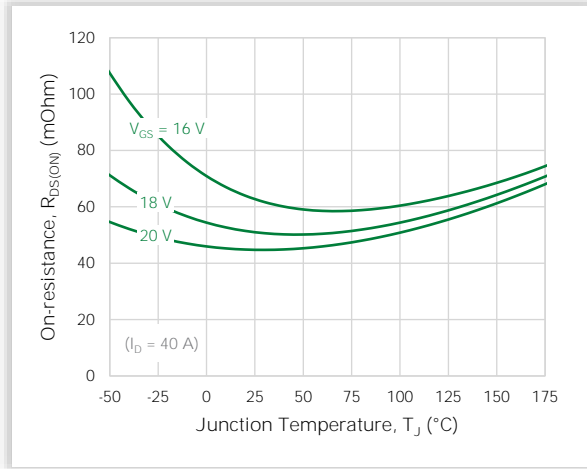

Figure 14. Typical Threshold Voltage

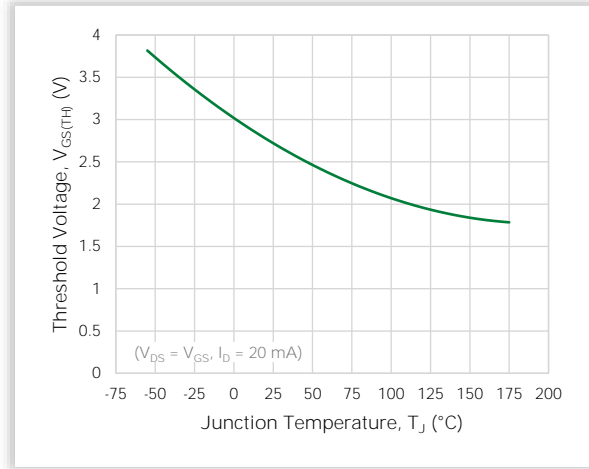

Figure 15. Typical Junction Capacitances up to 1000 V

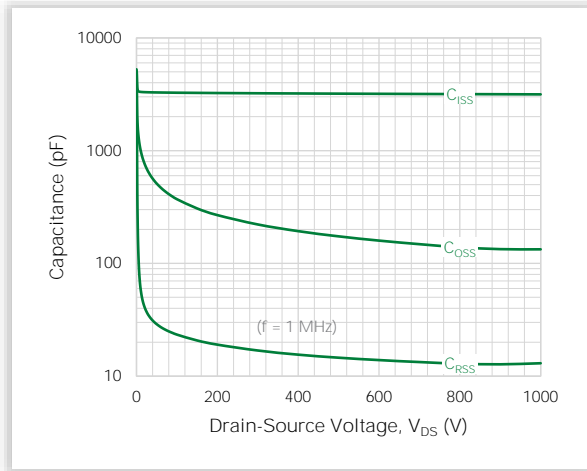

Figure 16. Typical Junction Capacitances up to 200 V

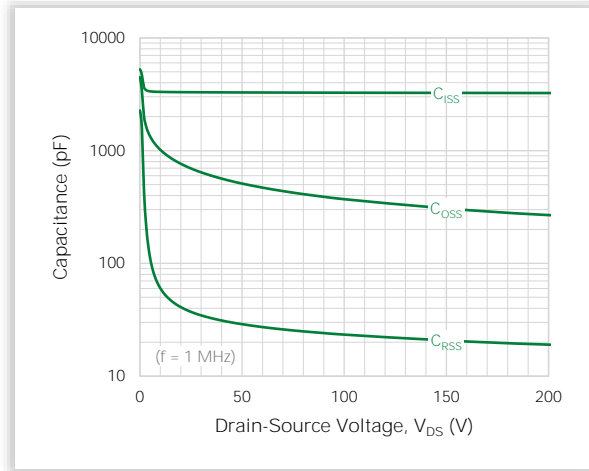

Figure 17. Typical C_{oss} Stored Energy E_{oss}

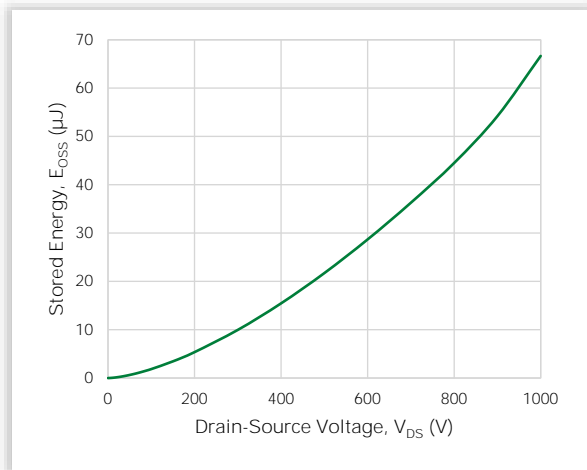

Figure 18. Typical Gate Charge

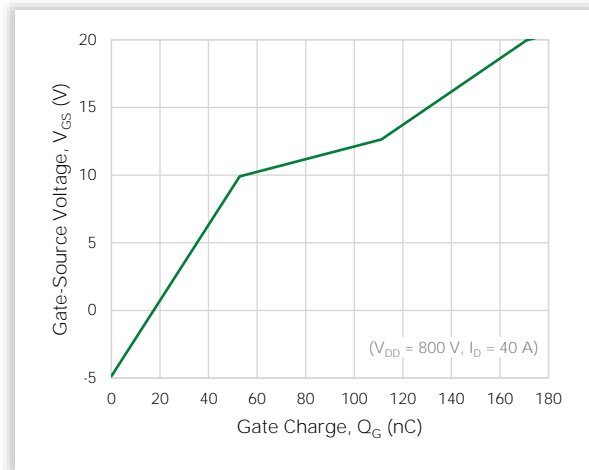

Figure 19. Typical Switching Energy vs. Drain Current

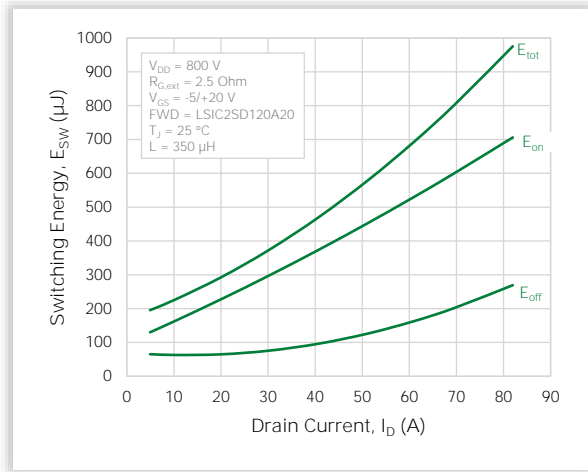

Figure 20. Typical Switching Energy vs. External Gate Resistance

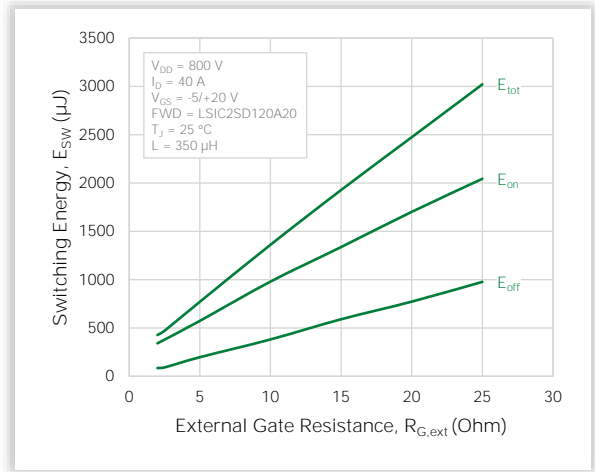
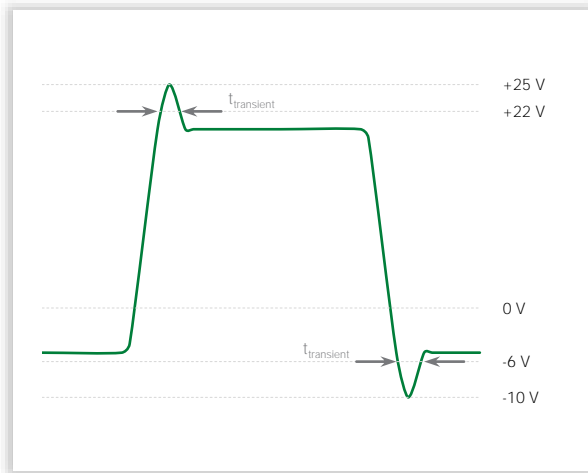
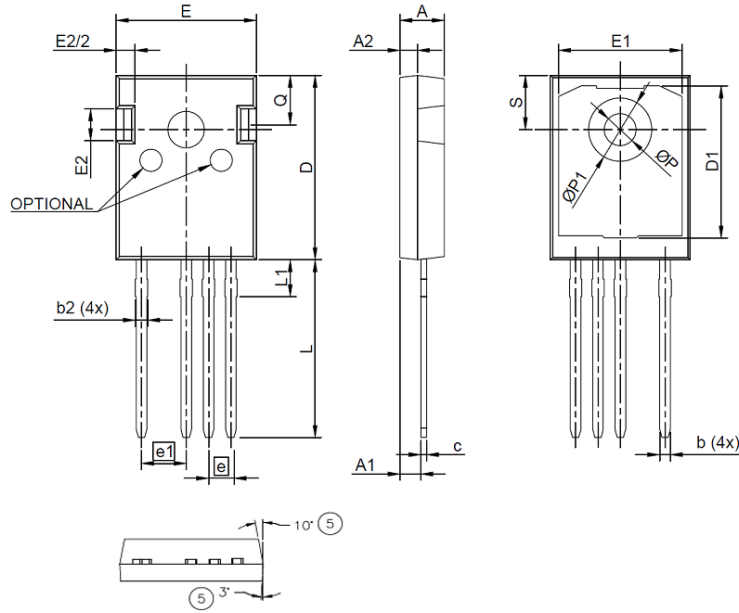

Figure 21. V_{GS} Waveform Definition



6. Package Dimensions



Symbol	Millimeters	
	Min	Max
A	4.70	5.31
A1	2.21	2.59
A2	1.50	2.49
b	0.99	1.40
b2	1.65	2.39
c	0.38	0.89
D	20.80	21.46
D1	13.08	-
D2	0.51	1.35
E	15.49	16.26
e	2.54 BSC	
e1	4.83	5.33
E1	13.46	-
E2	3.56	4.06
L	19.81	20.32
L1	-	4.50
øP	3.56	3.66
øP1	7.06	7.39
Q	5.38	6.20
S	6.17 BSC	

Recommended Hole Pattern Layout:

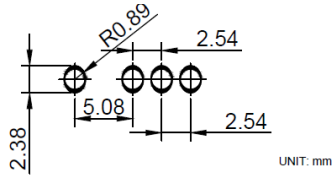

Notes:

1. Dimensioning and tolerancing as per ASME Y14.5 – 2009.
2. Package outline in compliance with JEDEC Standard Var. Ad.
3. Dimension D, E do not include mold flash.
4. Mold draft angles excluded on the table.
5. øP to have a maximum draft angle of 1.7° to the top with a maximum hole diameter of 3.912 mm.

7. Part Numbering and Marking

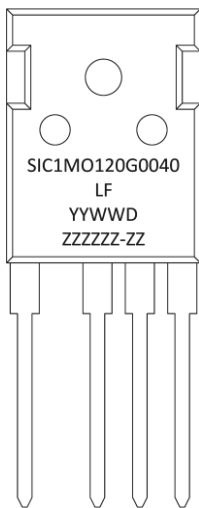

- SiC = SiC
- 1 = Gen 1
- MO = MOSFET
- 120 = Voltage Rating (1200 V)
- G = TO-247-4L
- 0040 = $R_{DS(ON)}$ (40 mOhm)
- YY = Year
- WW = Week
- D = Special Code
- ZZZZZZ-ZZ = Lot Number

8. Packing Options

Part Number	Marking	Packing Mode	M.O.Q.
LSIC1MO120G0040	SIC1MO120G0040	Tube (30 pcs)	450

9. Packing Specifications

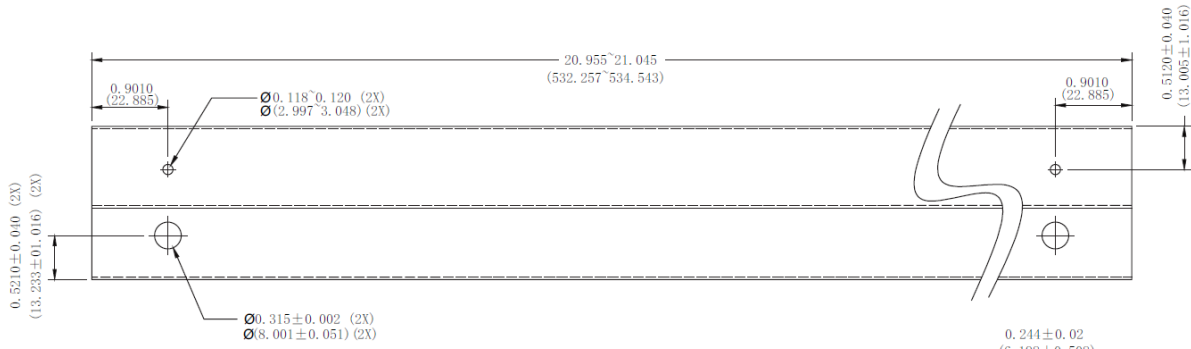

NOTE:

- 1. All pin plug holes are considered critical dimension
- 2. Tolerance is to be ±0.010 unless otherwise specified
- 3. Dimension are in inch (and millimeters).

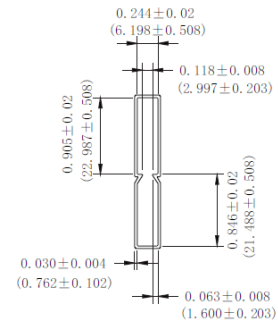

For additional information please visit www.Littelfuse.com/powersemi

Disclaimer Notice - Littelfuse products are not designed for, and shall not be used for, any purpose (including, without limitation, automotive, military, aerospace, medical, life-saving, life-sustaining or nuclear facility applications, devices intended for surgical implant into the body, or any other application in which the failure or lack of desired operation of the product may result in personal injury, death, or property damage) other than those expressly forth in applicable Littelfuse product documentation. Littelfuse shall not be liable for any claims or damages arising out of products used in applications not expressly intended by Littelfuse as set forth in applicable Littelfuse documentation.

Read complete Disclaimer Notice at www.littelfuse.com/disclaimer-electronics

Mouser Electronics

Authorized Distributor

Click to View Pricing, Inventory, Delivery & Lifecycle Information:

[Littelfuse:](#)

[LSIC1MO120G0040](#)