

High Voltage IGBTs w/Diode

IXGH40N120B2D1 IXGT40N120B2D1

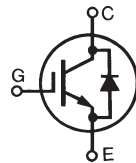

$V_{CES} = 1200V$
 $I_{C110} = 40A$
 $V_{CE(sat)} \leq 3.5V$
 $t_{fi(typ)} = 140ns$

Symbol	Test Conditions	Maximum Ratings	
V_{CES}	$T_C = 25^\circ C$ to $150^\circ C$	1200	V
V_{CGR}	$T_J = 25^\circ C$ to $150^\circ C$, $R_{GE} = 1M\Omega$	1200	V
V_{GES}	Continuous	± 20	V
V_{GEM}	Transient	± 30	V
I_{C25}	$T_C = 25^\circ C$ (Limited by Lead)	75	A
I_{C110}	$T_C = 110^\circ C$	40	A
I_{F110}	$T_C = 110^\circ C$	25	A
I_{CM}	$T_C = 25^\circ C$, 1ms	200	A
SSOA (RBSOA)	$V_{GE} = 15V$, $T_{VJ} = 125^\circ C$, $R_G = 2\Omega$ Clamped Inductive Load	$I_{CM} = 80$ @ $0.8 \leq V_{CES}$	A V
P_C	$T_C = 25^\circ C$	380	W
T_J		-55 ... +150	$^\circ C$
T_{JM}		150	$^\circ C$
T_{stg}		-55 ... +150	$^\circ C$
T_L	1.6mm (0.062 in.) from Case for 10s	300	$^\circ C$
T_{SOLD}	Plastic Body for 10 seconds	260	$^\circ C$
M_d	Mounting Torque (TO-247)	1.13/10	Nm/lb.in.
Weight	TO-247	6	g
	TO-268	4	g

TO-247 (IXGH)

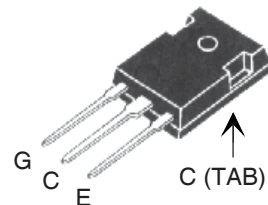

TO-268 (IXGT)

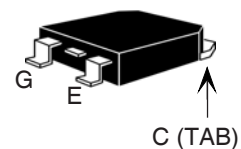

G = Gate C = Collector
 E = Emitter TAB = Collector

Features

- International Standard Packages
- IGBT and Anti-Parallel FRED for Resonant Power Supplies
 - Induction Heating
 - Rice Cookers
- Square RBSOA
- Fast Recovery Exipitaxial Diode (FRED)
 - Soft Recovery with Low I_{RM}

Advantages

- High Power Density
- Low Gate Drive Requirement

Symbol	Test Conditions	Characteristic Values		
		Min.	Typ.	Max.
$V_{GE(th)}$	$I_C = 250\mu A$, $V_{CE} = V_{GE}$	3.0		5.0 V
I_{CES}	$V_{CE} = V_{CES}$, $V_{GE} = 0V$			100 μA 3 mA
		$T_J = 125^\circ C$		
I_{GES}	$V_{CE} = 0V$, $V_{GE} = \pm 20V$			± 100 nA
$V_{CE(sat)}$	$I_C = 40A$, $V_{GE} = 15V$, Note 1		2.9	3.5 V

Symbol	Test Conditions	Characteristic Values		
		Min.	Typ.	Max.
g_{fs}	$I_C = 40A, V_{CE} = 10V, \text{Note 1}$	23	37	S
C_{ies}	$V_{CE} = 25V, V_{GE} = 0V, f = 1MHz$		3360	pF
C_{oes}			190	pF
C_{res}			63	pF
Q_g	$I_C = 40A, V_{GE} = 15V, V_{CE} = 0.5 \cdot V_{CES}$		138	nC
Q_{ge}			20	nC
Q_{gc}			48	nC
$t_{d(on)}$	Inductive load, $T_J = 25^\circ C$ $I_C = 40A, V_{GE} = 15V$ $V_{CE} = 960V, R_G = 2\Omega$ Note 2		21	ns
t_{ri}			55	ns
E_{on}			4.5	mJ
$t_{d(off)}$			290	ns
t_{fi}			140	270
E_{off}		3.0	6.0	mJ
$t_{d(on)}$	Inductive load, $T_J = 125^\circ C$ $I_C = 40A, V_{GE} = 15V$ $V_{CE} = 960V, R_G = 2\Omega$ Note 2		21	ns
t_{ri}			58	ns
E_{on}			6.5	mJ
$t_{d(off)}$			350	ns
t_{fi}			420	ns
E_{off}		8.3	mJ	
R_{thJC}			0.33	$^\circ C/W$
R_{thCS}		0.21		$^\circ C/W$

Reverse Diode (FRED)

Symbol	Test Conditions	Characteristic Values		
		Min.	Typ.	Max.
V_F	$I_F = 30A, V_{GE} = 0V$			2.8 V
		$T_J = 150^\circ C$	1.6	V
I_{RM}	$I_F = 30A, -di/dt = 100A/\mu s,$ $V_R = 300V, V_{GE} = 0V$	$T_J = 100^\circ C$		4 A
t_{rr}		$T_J = 100^\circ C$	100	ns
R_{thJC}				0.9 $^\circ C/W$

Note 1: Pulse Test, $t \leq 300\mu s$, Duty Cycle, $d \leq 2\%$.
 2. Switching Times may Increase for $V_{CE} (\text{Clamp}) > 0.8 \cdot V_{CES}$,
 Higher T_J or Increased R_G .

TO-247 (IXGH) Outline

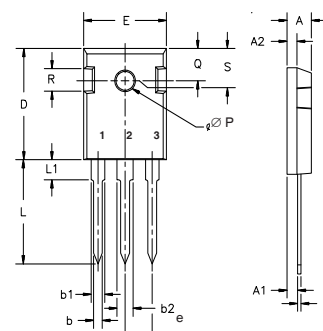

Terminals: 1 - Gate
 2 - Drain
 3 - Source
 Tab - Drain

Dim.	Millimeter		Inches	
	Min.	Max.	Min.	Max.
A	4.7	5.3	.185	.209
A ₁	2.2	2.54	.087	.102
A ₂	2.2	2.6	.059	.098
b	1.0	1.4	.040	.055
b ₁	1.65	2.13	.065	.084
b ₂	2.87	3.12	.113	.123
C	.4	.8	.016	.031
D	20.80	21.46	.819	.845
E	15.75	16.26	.610	.640
e	5.20	5.72	0.205	0.225
L	19.81	20.32	.780	.800
L ₁		4.50		.177
∅P	3.55	3.65	.140	.144
Q	5.89	6.40	0.232	0.252
R	4.32	5.49	.170	.216
S	6.15	BSC	242	BSC

TO-268 (IXGT) Outline

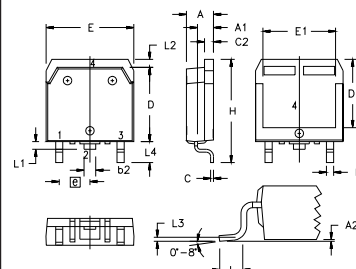

SYM	INCHES		MILLIMETERS	
	MIN	MAX	MIN	MAX
A	.193	.201	4.90	5.10
A ₁	.106	.114	2.70	2.90
A ₂	.001	.010	0.02	0.25
b	.045	.057	1.15	1.45
b ₂	.075	.083	1.90	2.10
C	.016	.026	0.40	0.65
C ₂	.057	.063	1.45	1.60
D	.543	.551	13.80	14.00
D ₁	.488	.500	12.40	12.70
E	.624	.632	15.85	16.05
E ₁	.524	.535	13.30	13.60
e	.215 BSC		5.45 BSC	
H	.736	.752	18.70	19.10
L	.094	.106	2.40	2.70
L ₁	.047	.055	1.20	1.40
L ₂	.039	.045	1.00	1.15
L ₃	.010 BSC		0.25 BSC	
L ₄	.150	.161	3.80	4.10

IXYS Reserves the Right to Change Limits, Test Conditions and Dimensions.

IXYS MOSFETs and IGBTs are covered by one or more of the following U.S. patents:

4,835,592	4,931,844	5,049,961	5,237,481	6,162,665	6,404,065 B1	6,683,344	6,727,585	7,005,734 B2	7,157,338B2
4,850,072	5,017,508	5,063,307	5,381,025	6,259,123 B1	6,534,343	6,710,405 B2	6,759,692	7,063,975 B2	
4,881,106	5,034,796	5,187,117	5,486,715	6,306,728 B1	6,583,505	6,710,463	6,771,478 B2	7,071,537	

Fig. 1. Output Characteristics @ 25°C

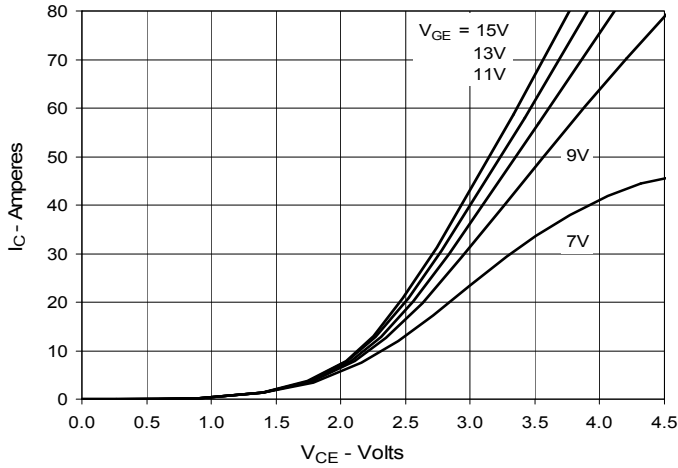

Fig. 2. Extended Output Characteristics @ 25°C

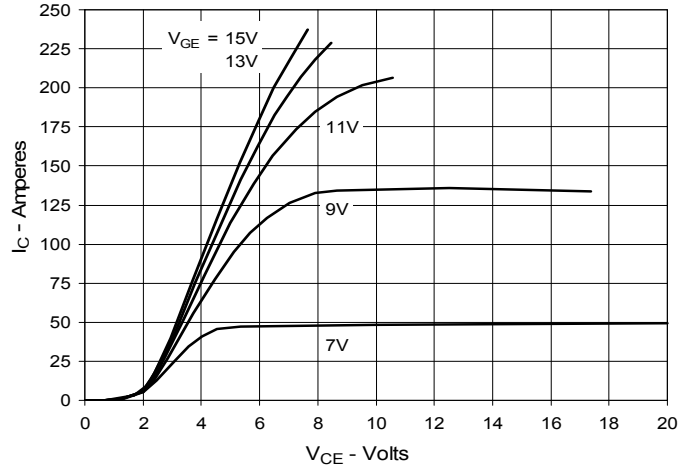

Fig. 3. Output Characteristics @ 125°C

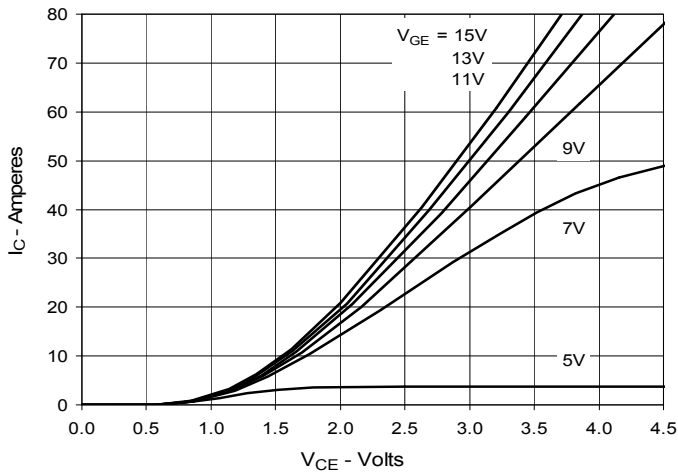

Fig. 4. Dependence of $V_{CE(sat)}$ on Junction Temperature

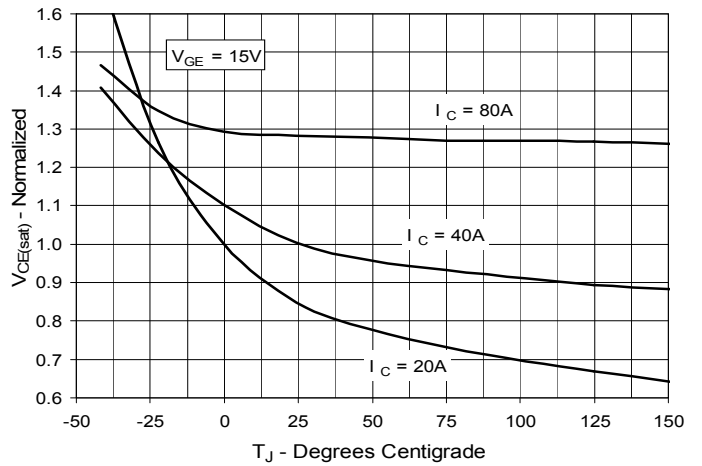

Fig. 5. Collector-to-Emitter Voltage vs. Gate-to-Emitter Voltage

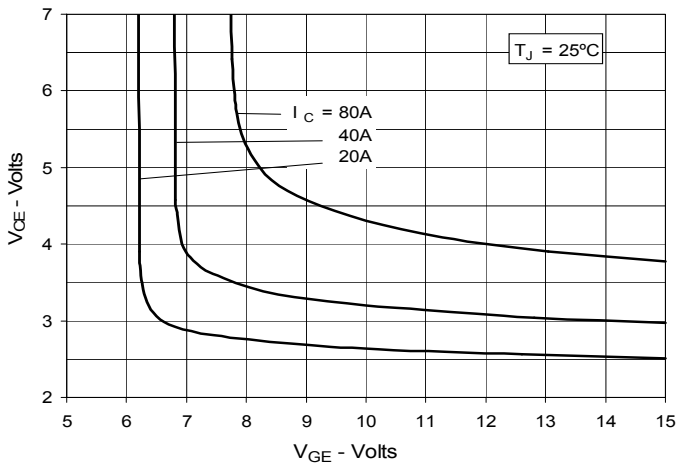

Fig. 6. Input Admittance

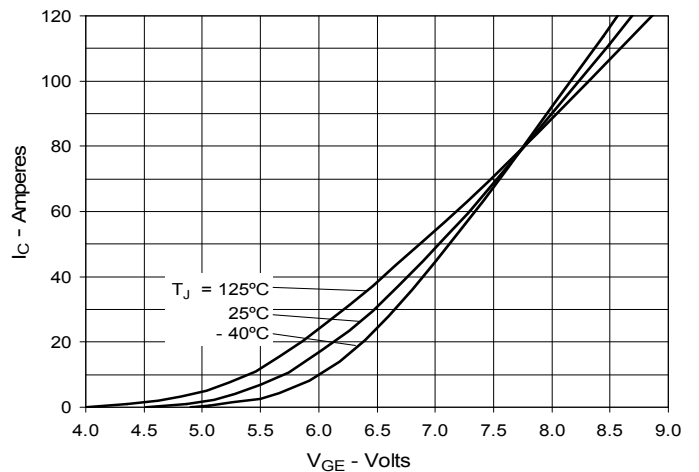

Fig. 7. Transconductance

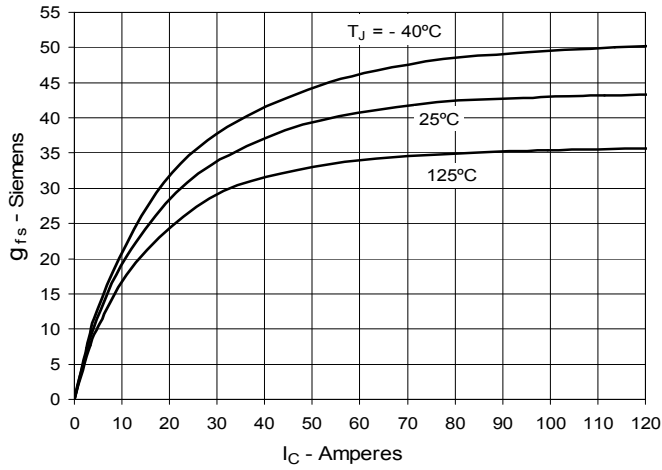

Fig. 8. Gate Charge

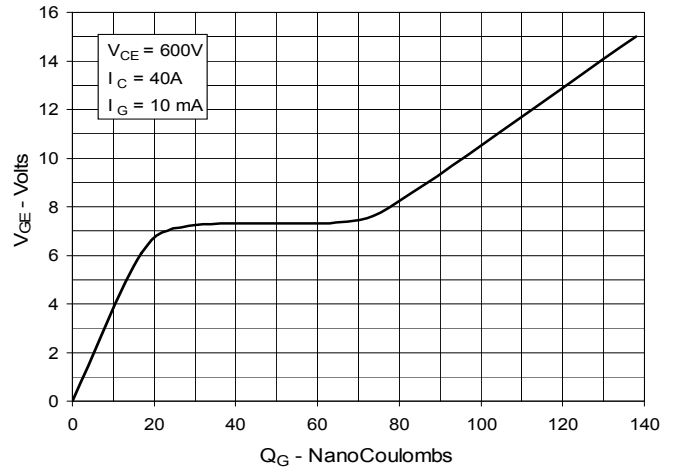

Fig. 9. Capacitance

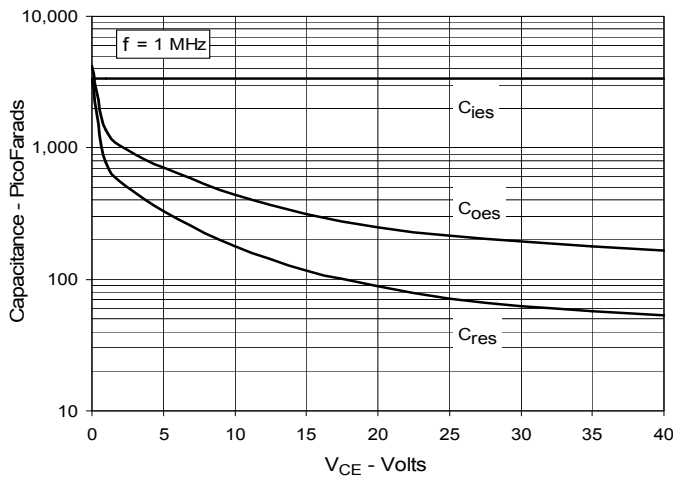

Fig. 10. Reverse-Bias Safe Operating Area

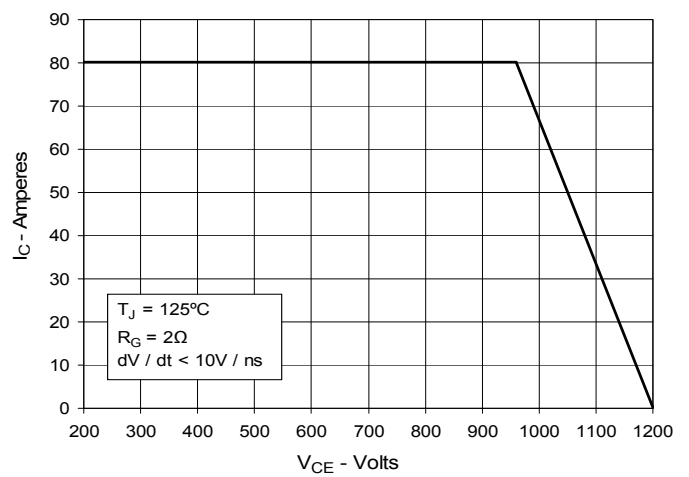

Fig. 11. Maximum Transient Thermal Impedance

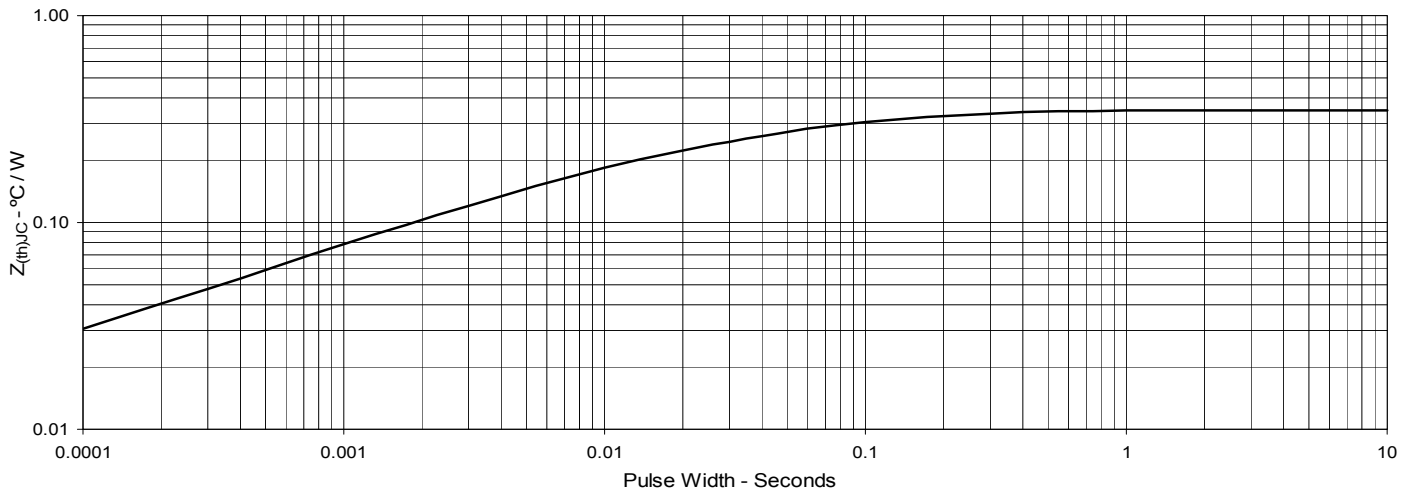

Fig. 12. Inductive Switching Energy Loss vs. Gate Resistance

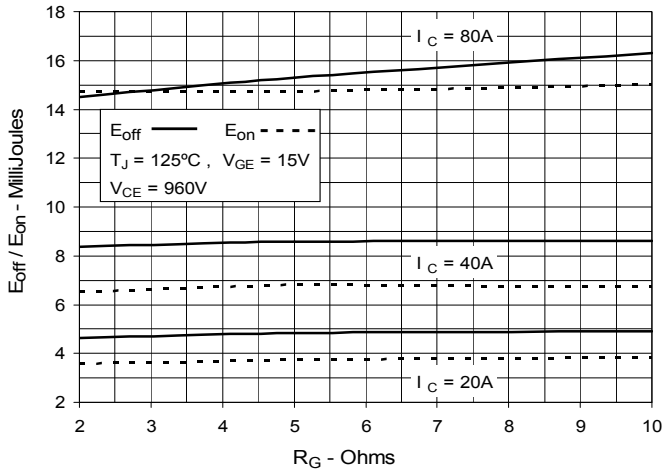

Fig. 13. Inductive Switching Energy Loss vs. Junction Temperature

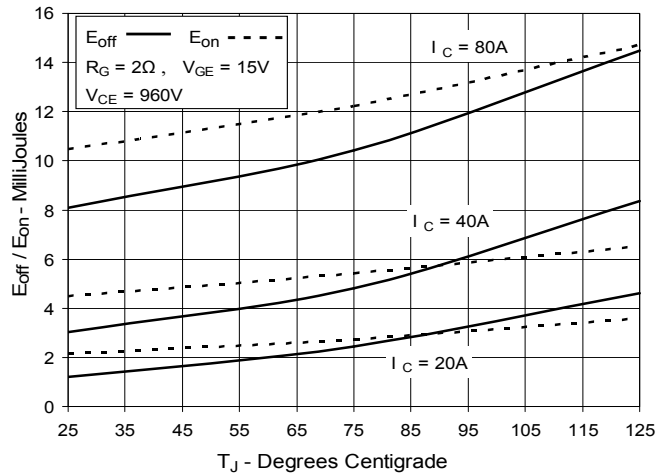

Fig. 14. Inductive Switching Energy Loss vs. Collector Current

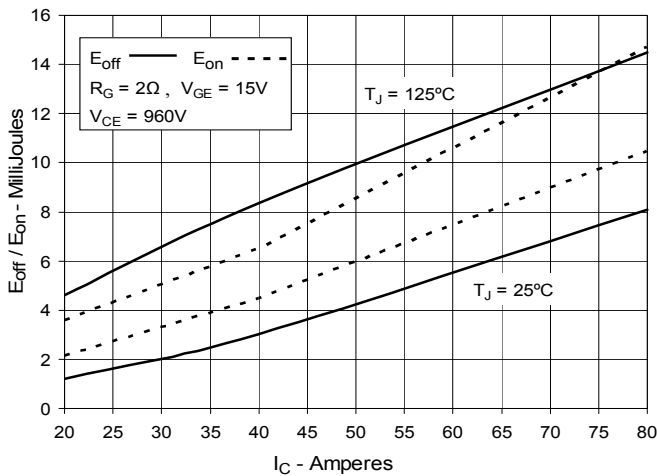

Fig. 15. Inductive Turn-off Switching Times vs. Gate Resistance

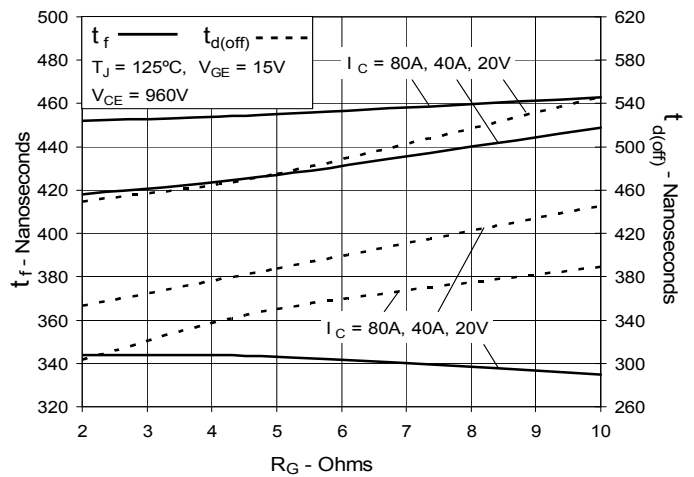

Fig. 16. Inductive Turn-off Switching Times vs. Junction Temperature

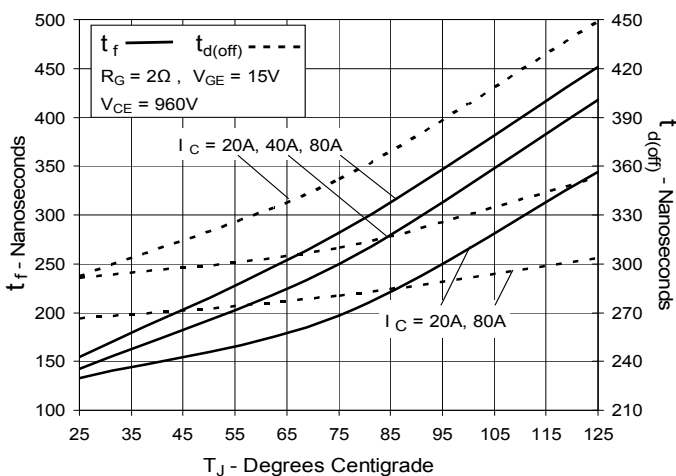

Fig. 17. Inductive Turn-off Switching Times vs. Collector Current

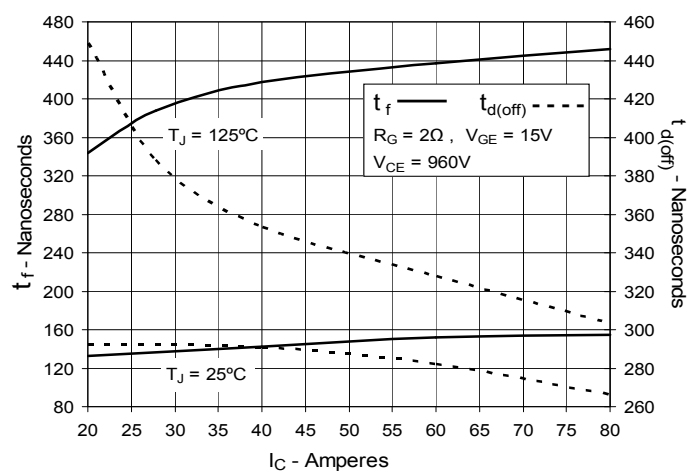

Fig. 18. Inductive Turn-on Switching Times vs. Gate Resistance

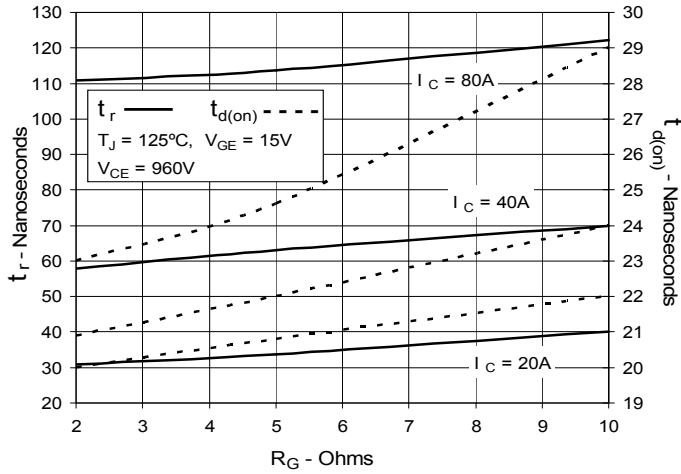

Fig. 19. Inductive Turn-on Switching Times vs. Junction Temperature

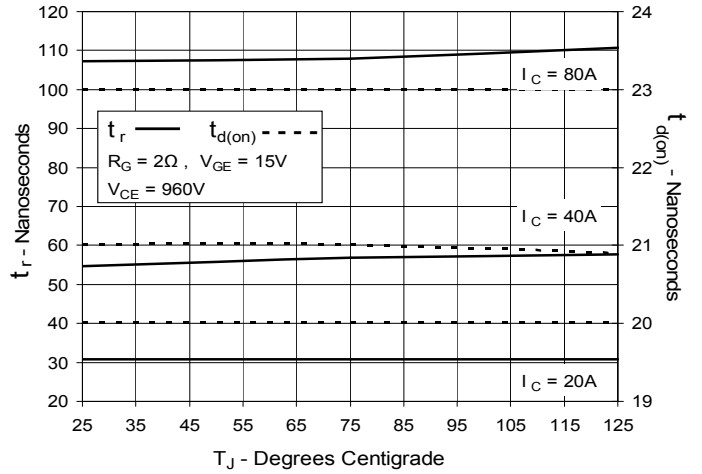
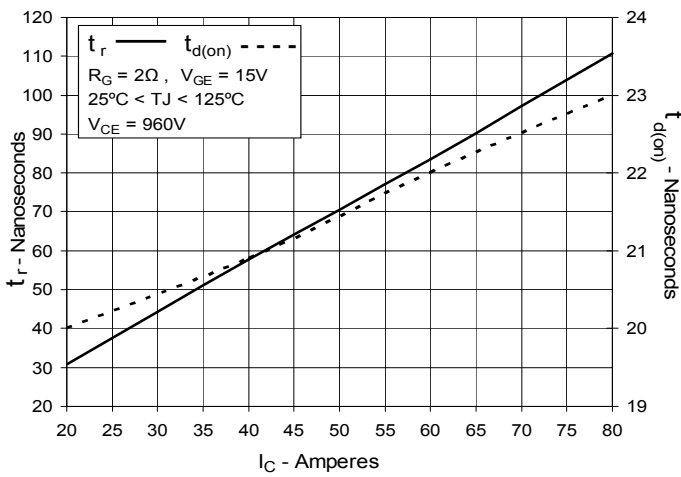

Fig. 20. Inductive Turn-on Switching Times vs. Collector Current



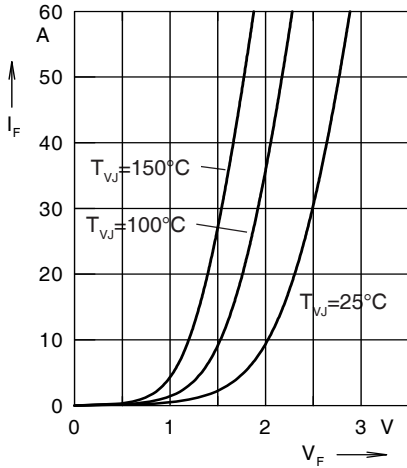

Fig. 21. Forward current I_F versus V_F

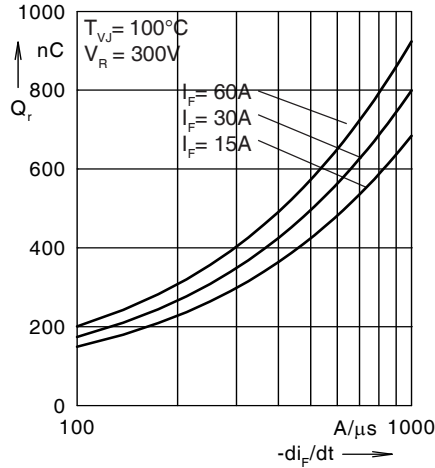

Fig. 22. Reverse recovery charge Q_r versus $-di_F/dt$

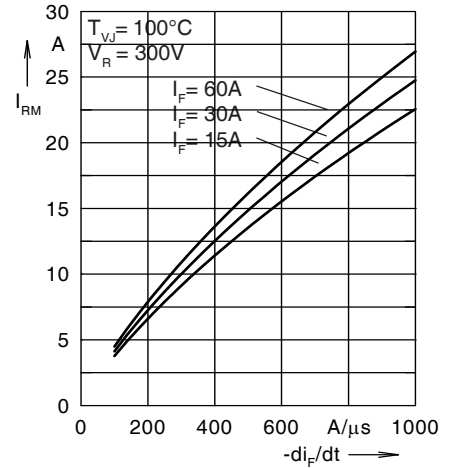

Fig. 23. Peak reverse current I_{RM} versus $-di_F/dt$

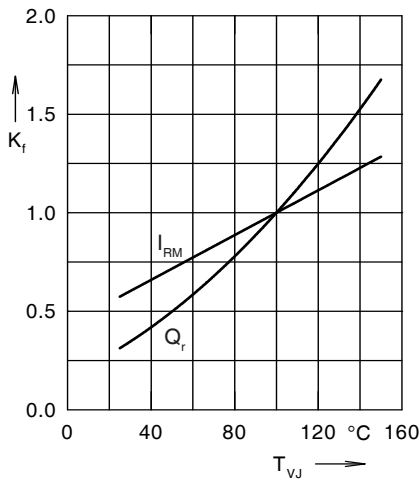

Fig. 24. Dynamic parameters Q_r , I_{RM} versus T_{VJ}

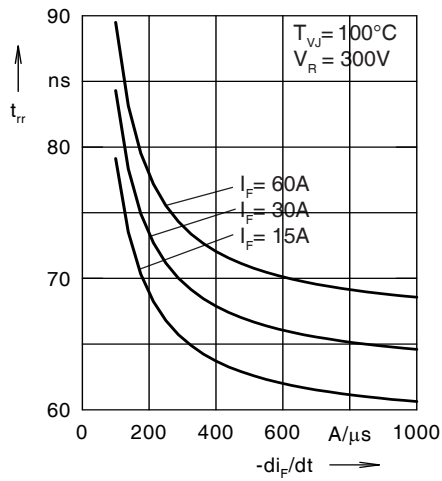

Fig. 25. Recovery time t_{rr} versus $-di_F/dt$

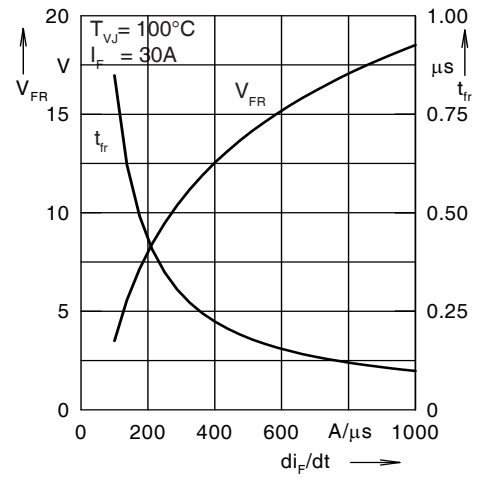

Fig. 26. Peak forward voltage V_{FR} and t_{fr} versus di_F/dt

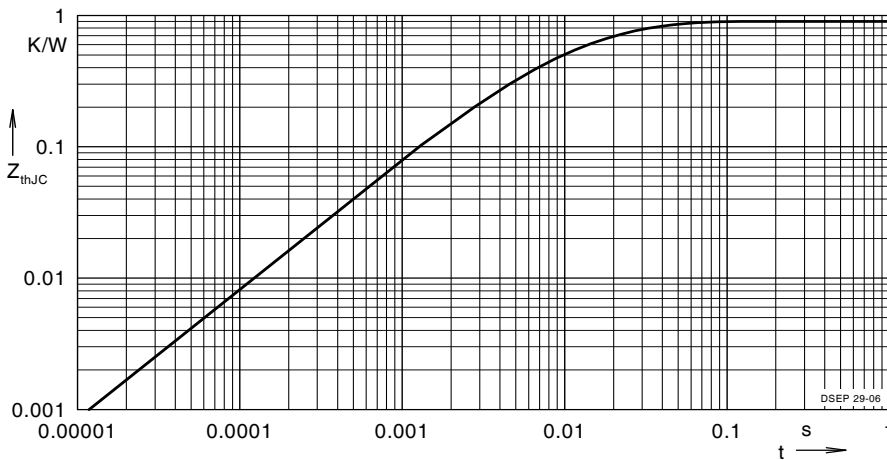

Fig. 27. Transient thermal resistance junction to case

Constants for Z_{thJC} calculation

i	R_{th} (°C/W)	t_i (s)
1	0.465	0.0052
2	0.179	0.0003
3	0.256	0.0397

Mouser Electronics

Authorized Distributor

Click to View Pricing, Inventory, Delivery & Lifecycle Information:

[IXYS:](#)

[IXGT40N120B2D1](#) [IXGH40N120B2D1](#)