

LinearL2™
Power MOSFET
w/ Extended FBSOA

IXTK90N25L2
IXTX90N25L2

V_{DSS} = 250V
I_{D25} = 90A
R_{DS(on)} ≤ 36mΩ

N-Channel Enhancement Mode
 Avalanche Rated



Symbol	Test Conditions	Maximum Ratings	
V _{DSS}	T _J = 25°C to 150°C	250	V
V _{DGR}	T _J = 25°C to 150°C, R _{GS} = 1MΩ	250	V
V _{GSS}	Continuous	±20	V
V _{GSM}	Transient	±30	V
I _{D25}	T _C = 25°C	90	A
I _{DM}	T _C = 25°C, Pulse Width Limited by T _{JM}	360	A
I _A	T _C = 25°C	45	A
E _{AS}	T _C = 25°C	3	J
P _D	T _C = 25°C	960	W
T _J		-55...+150	°C
T _{JM}		150	°C
T _{stg}		-55...+150	°C
T _L	Maximum Lead Temperature for Soldering	300	°C
T _{SOLD}	1.6 mm (0.062in.) from Case for 10s	260	°C
M _d	Mounting Torque (TO-264)	1.13/10	Nm/lb.in
F _C	Mounting Force (PLUS247)	20..120 /4.5..27	N/lb
Weight	TO-264	10	g
	PLUS247	6	g

TO-264 (IXTK)

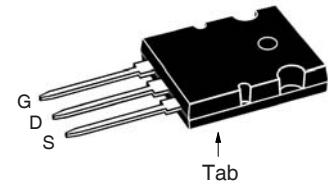

PLUS247 (IXTX)

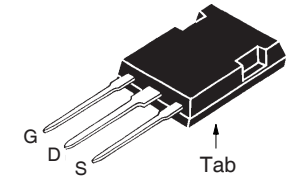

G = Gate D = Drain
 S = Source Tab = Drain

Features

- Designed for Linear Operation
- International Standard Packages
- Avalanche Rated
- Guaranteed FBSOA at 75°C

Advantages

- Easy to Mount
- Space Savings
- High Power Density

Applications

- Solid State Circuit Breakers
- Soft Start Controls
- Linear Amplifiers
- Programmable Loads
- Current Regulators

Symbol	Test Conditions (T _J = 25°C, Unless Otherwise Specified)	Characteristic Values		
		Min.	Typ.	Max.
BV _{DSS}	V _{GS} = 0V, I _D = 1mA	250		V
V _{GS(th)}	V _{DS} = V _{GS} , I _D = 3mA	2.0		V
I _{GSS}	V _{GS} = ±20V, V _{DS} = 0V			±200 nA
I _{DSS}	V _{DS} = V _{DSS} , V _{GS} = 0V T _J = 125°C			50 μA 2.5 mA
R _{DS(on)}	V _{GS} = 10V, I _D = 0.5 • I _{D25} , Note 1			36 mΩ

Symbol	Test Conditions ($T_J = 25^\circ\text{C}$, Unless Otherwise Specified)	Characteristic Values			
		Min.	Typ.	Max.	
g_{fs}	$V_{DS} = 10\text{V}$, $I_D = 0.5 \cdot I_{D25}$, Note 1	35	50	65	S
C_{iss}	$V_{GS} = 0\text{V}$, $V_{DS} = 25\text{V}$, $f = 1\text{MHz}$		23		nF
C_{oss}			2140		pF
C_{rss}			360		pF
$t_{d(on)}$	Resistive Switching Times $V_{GS} = 10\text{V}$, $V_{DS} = 0.5 \cdot V_{DSS}$, $I_D = 0.5 \cdot I_{D25}$ $R_G = 1\Omega$ (External)		50		ns
t_r			175		ns
$t_{d(off)}$			40		ns
t_f			160		ns
$Q_{g(on)}$	$V_{GS} = 10\text{V}$, $V_{DS} = 0.5 \cdot V_{DSS}$, $I_D = 0.5 \cdot I_{D25}$		640		nC
Q_{gs}			125		nC
Q_{gd}			385		nC
R_{thJC}				0.13	$^\circ\text{C/W}$
R_{thCS}				0.15	$^\circ\text{C/W}$

Safe Operating Area Specification

Symbol	Test Conditions	Characteristic Values			
		Min.	Typ.	Max.	
SOA	$V_{DS} = 250\text{V}$, $I_D = 2.3\text{A}$, $T_C = 75^\circ\text{C}$, $T_p = 5\text{s}$	575			W

Source-Drain Diode

Symbol	Test Conditions ($T_J = 25^\circ\text{C}$, Unless Otherwise Specified)	Characteristic Values			
		Min.	Typ.	Max.	
I_S	$V_{GS} = 0\text{V}$			90	A
I_{SM}	Repetitive, Pulse Width Limited by T_{JM}			360	A
V_{SD}	$I_F = 45\text{A}$, $V_{GS} = 0\text{V}$, Note 1			1.5	V
t_{rr}	$I_F = 45\text{A}$, $-di/dt = 100\text{A}/\mu\text{s}$, $V_R = 80\text{V}$, $V_{GS} = 0\text{V}$		266		ns
I_{RM}			23		A
Q_{RM}			3.0		μC

Note: 1. Pulse test, $t \leq 300\mu\text{s}$, duty cycle, $d \leq 2\%$.

IXYS Reserves the Right to Change Limits, Test Conditions, and Dimensions.

IXYS MOSFETs and IGBTs are covered by one or more of the following U.S. patents:	4,835,592	4,931,844	5,049,961	5,237,481	6,162,665	6,404,065 B1	6,683,344	6,727,585	7,005,734 B2	7,157,338B2
	4,860,072	5,017,508	5,063,307	5,381,025	6,259,123 B1	6,534,343	6,710,405 B2	6,759,692	7,063,975 B2	
	4,881,106	5,034,796	5,187,117	5,486,715	6,306,728 B1	6,583,505	6,710,463	6,771,478 B2	7,071,537	

TO-264 AA Outline

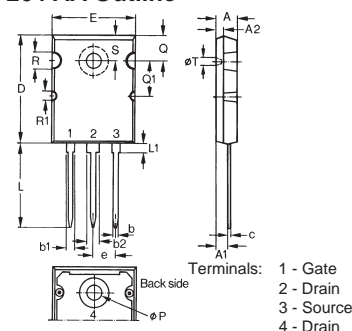

Dim.	Millimeter		Inches	
	Min.	Max.	Min.	Max.
A	4.82	5.13	.190	.202
A1	2.54	2.89	.100	.114
A2	2.00	2.10	.079	.083
b	1.12	1.42	.044	.056
b1	2.39	2.69	.094	.106
b2	2.90	3.09	.114	.122
c	0.53	0.83	.021	.033
D	25.91	26.16	1.020	1.030
E	19.81	19.96	.780	.786
e	5.46 BSC		.215 BSC	
J	0.00	0.25	.000	.010
K	0.00	0.25	.000	.010
L	20.32	20.83	.800	.820
L1	2.29	2.59	.090	.102
P	3.17	3.66	.125	.144
Q	6.07	6.27	.239	.247
Q1	8.38	8.69	.330	.342
R	3.81	4.32	.150	.170
R1	1.78	2.29	.070	.090
S	6.04	6.30	.238	.248
T	1.57	1.83	.062	.072

PLUS 247™ Outline

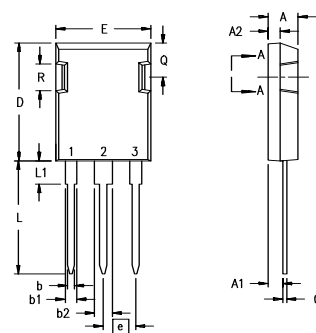

Terminals: 1 - Gate
2 - Drain
3 - Source

Dim.	Millimeter		Inches	
	Min.	Max.	Min.	Max.
A	4.83	5.21	.190	.205
A1	2.29	2.54	.090	.100
A2	1.91	2.16	.075	.085
b	1.14	1.40	.045	.055
b1	1.91	2.13	.075	.084
b2	2.92	3.12	.115	.123
C	0.61	0.80	.024	.031
D	20.80	21.34	.819	.840
E	15.75	16.13	.620	.635
e	5.45 BSC		.215 BSC	
L	19.81	20.32	.780	.800
L1	3.81	4.32	.150	.170
Q	5.59	6.20	.220	0.244
R	4.32	4.83	.170	.190

Fig. 1. Output Characteristics @ $T_J = 25^\circ\text{C}$

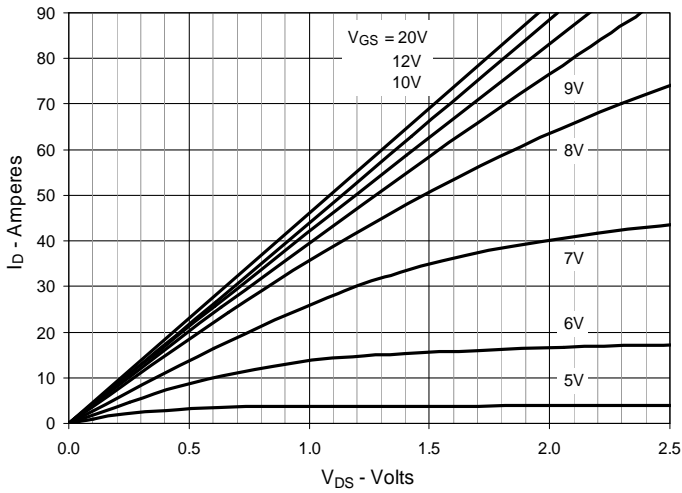

Fig. 2. Extended Output Characteristics @ $T_J = 25^\circ\text{C}$

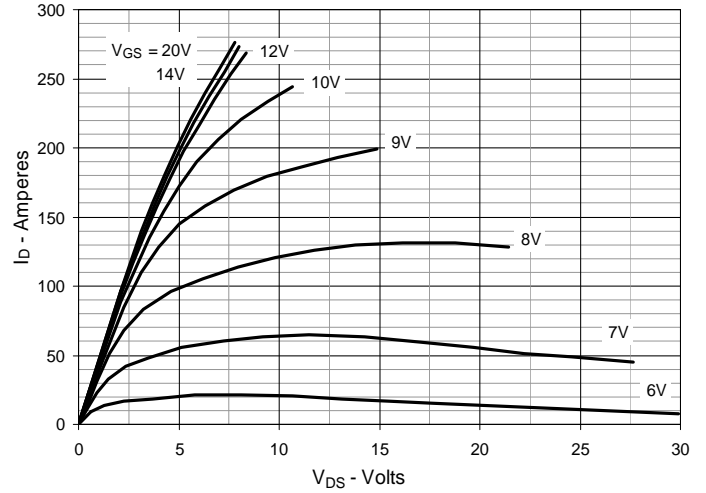

Fig. 3. Output Characteristics @ $T_J = 125^\circ\text{C}$

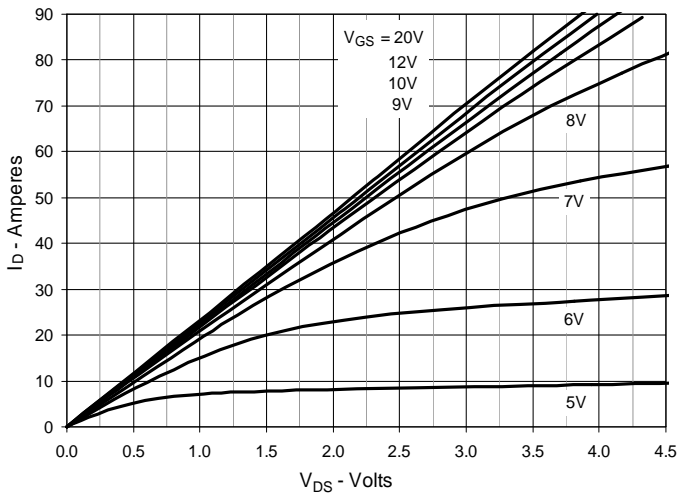

Fig. 4. $R_{DS(on)}$ Normalized to $I_D = 45\text{A}$ Value vs. Junction Temperature

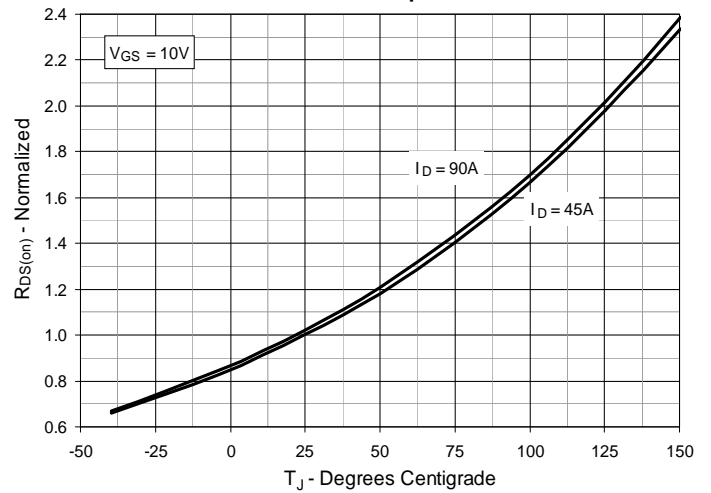

Fig. 5. $R_{DS(on)}$ Normalized to $I_D = 45\text{A}$ Value vs. Drain Current

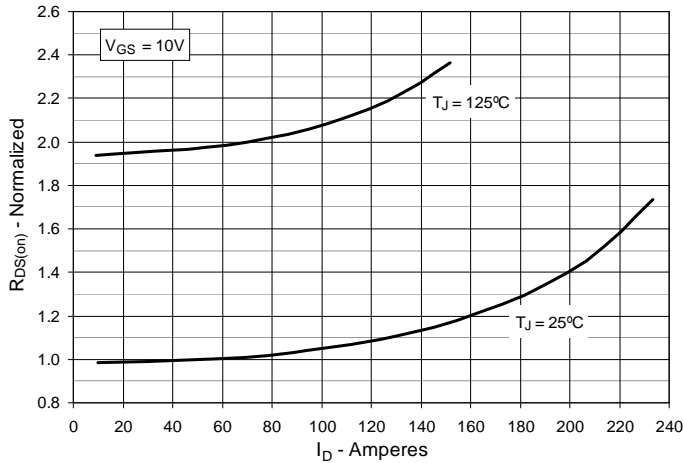

Fig. 6. Maximum Drain Current vs. Case Temperature

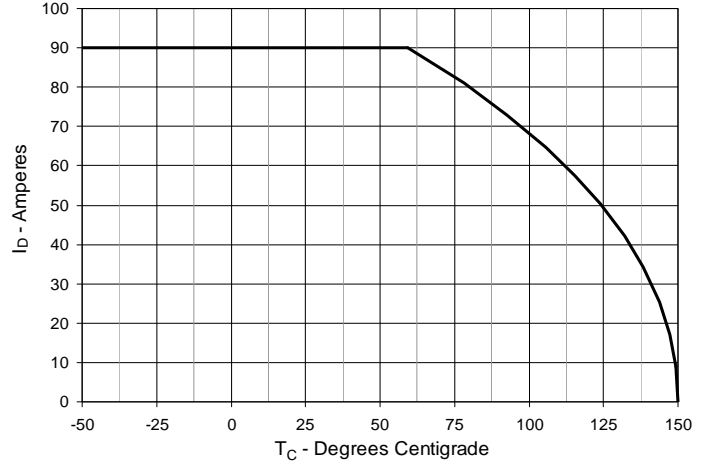

Fig. 7. Input Admittance

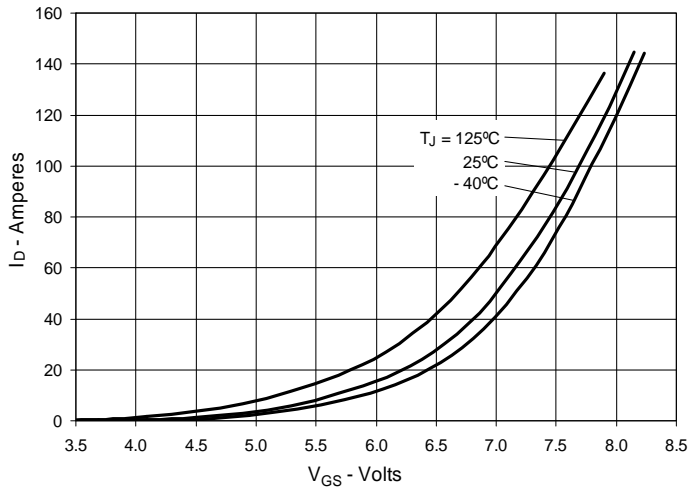

Fig. 8. Transconductance

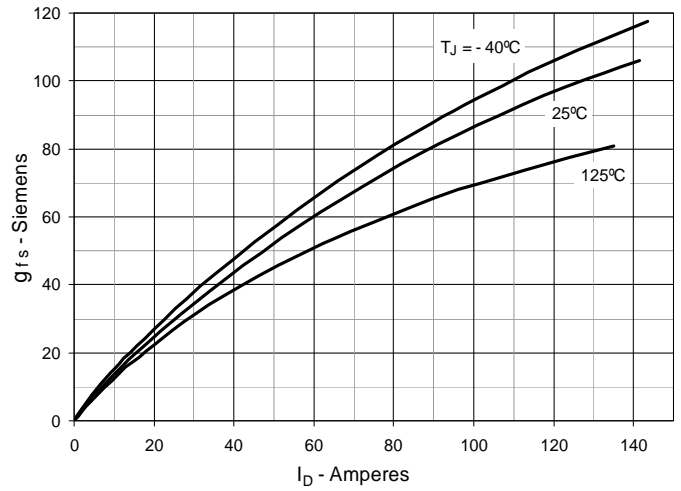

Fig. 9. Forward Voltage Drop of Intrinsic Diode

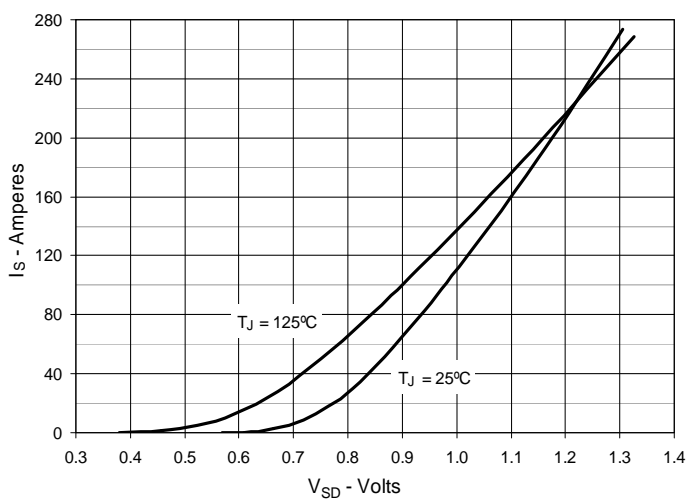

Fig. 10. Gate Charge

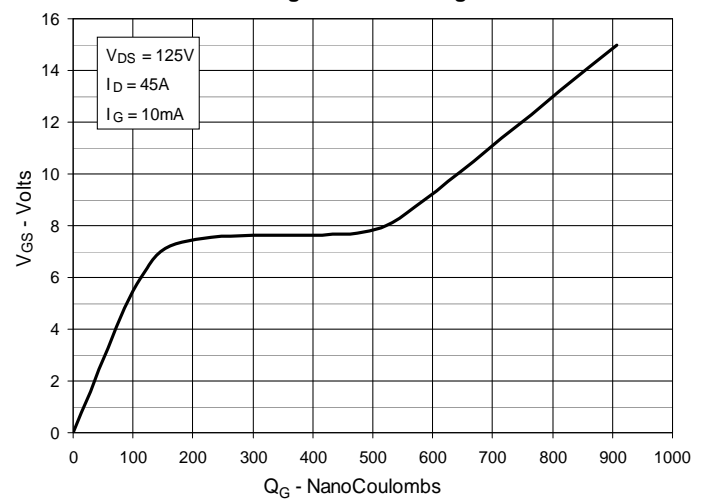

Fig. 11. Capacitance

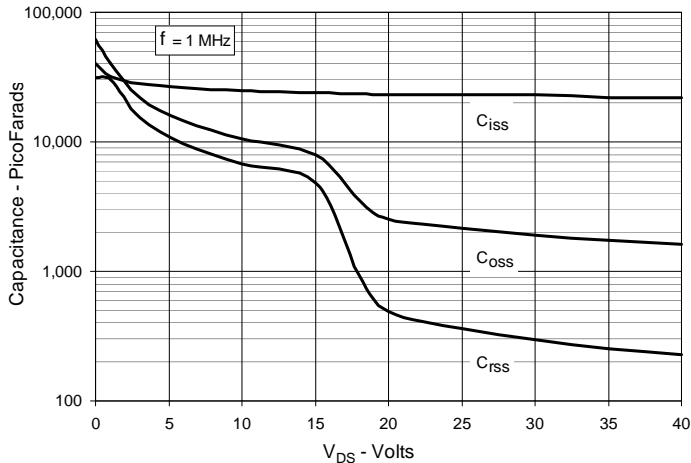

Fig. 12. Maximum Transient Thermal Impedance

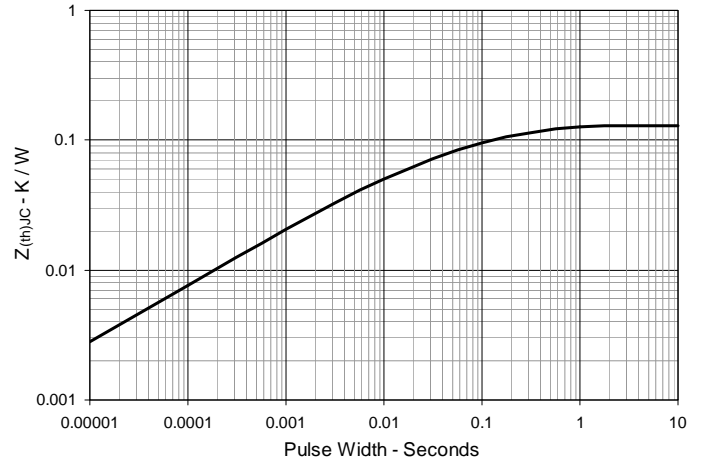

Fig. 13. Forward-Bias Safe Operating Area
@ $T_C = 25^\circ\text{C}$

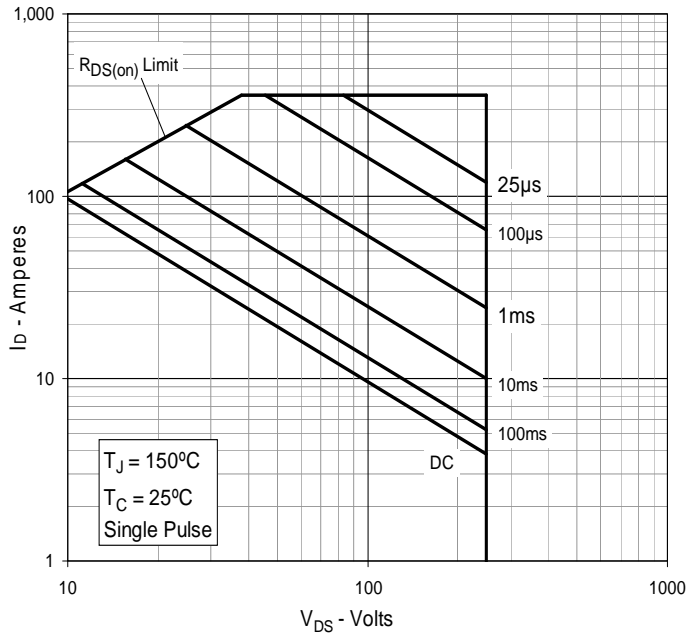
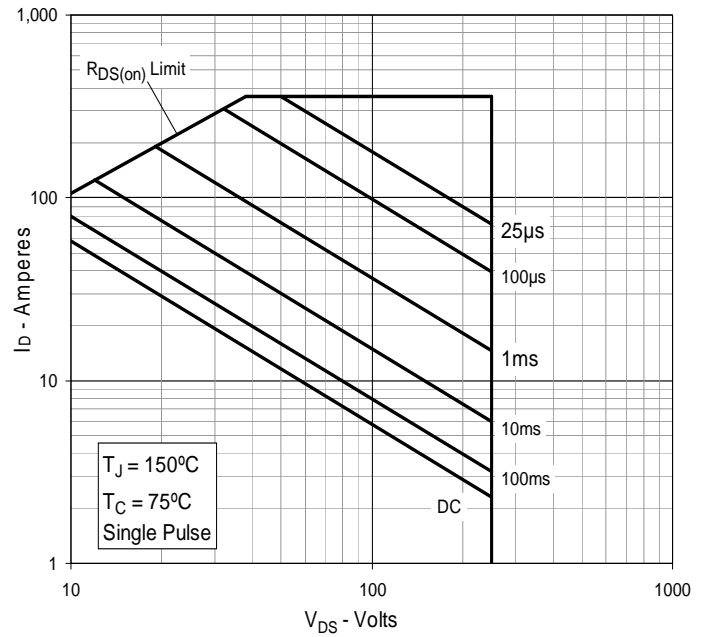

Fig. 14. Forward-Bias Safe Operating Area
@ $T_C = 75^\circ\text{C}$



Mouser Electronics

Authorized Distributor

Click to View Pricing, Inventory, Delivery & Lifecycle Information:

[IXYS:](#)

[IXTK90N25L2](#) [IXTX90N25L2](#)