

# Standard Rectifier Module

$$V_{RRM} = 2 \times 800 \text{ V}$$

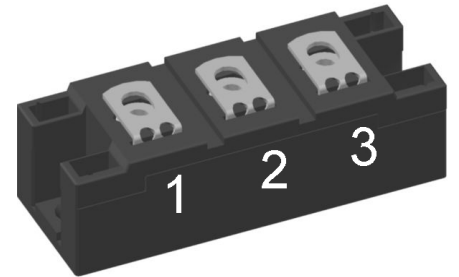
$$I_{FAV} = 165 \text{ A}$$

$$V_F = 1.05 \text{ V}$$

Phase leg

Part number

**MDD142-08N1**



Backside: isolated

 E72873



### Features / Advantages:

- Package with DCB ceramic
- Improved temperature and power cycling
- Planar passivated chips
- Very low forward voltage drop
- Very low leakage current

### Applications:

- Diode for main rectification
- For single and three phase bridge configurations
- Supplies for DC power equipment
- Input rectifiers for PWM inverter
- Battery DC power supplies
- Field supply for DC motors

### Package: Y4

- Isolation Voltage: 3600 V~
- Industry standard outline
- RoHS compliant
- Soldering pins for PCB mounting
- Base plate: DCB ceramic
- Reduced weight
- Advanced power cycling

### Disclaimer Notice

Information furnished is believed to be accurate and reliable. However, users should independently evaluate the suitability of and test each product selected for their own applications. Littelfuse products are not designed for, and may not be used in, all applications. Read complete Disclaimer Notice at [www.littelfuse.com/disclaimer-electronics](http://www.littelfuse.com/disclaimer-electronics).



Rectifier				Ratings			
Symbol	Definition	Conditions	min.	typ.	max.	Unit	
$V_{RSM}$	max. non-repetitive reverse blocking voltage				900	V	
$V_{RRM}$	max. repetitive reverse blocking voltage				800	V	
$I_R$	reverse current	$V_R = 800\text{ V}$			1	mA	
		$V_R = 800\text{ V}$			20	mA	
$V_F$	forward voltage drop	$I_F = 150\text{ A}$			1.12	V	
		$I_F = 300\text{ A}$			1.30	V	
		$I_F = 150\text{ A}$	$T_{VJ} = 125^\circ\text{C}$			1.05	V
		$I_F = 300\text{ A}$				1.26	V
$I_{FAV}$	average forward current	$T_C = 100^\circ\text{C}$			165	A	
$I_{F(RMS)}$	RMS forward current	180° sine			300	A	
$V_{F0}$	threshold voltage	} for power loss calculation only			0.80	V	
$r_F$	slope resistance				1.3	mΩ	
$R_{thJC}$	thermal resistance junction to case				0.21	K/W	
$R_{thCH}$	thermal resistance case to heatsink			0.08		K/W	
$P_{tot}$	total power dissipation		$T_C = 25^\circ\text{C}$		600	W	
$I_{FSM}$	max. forward surge current	$t = 10\text{ ms}; (50\text{ Hz}), \text{ sine}$	$T_{VJ} = 45^\circ\text{C}$		4.70	kA	
		$t = 8,3\text{ ms}; (60\text{ Hz}), \text{ sine}$	$V_R = 0\text{ V}$		5.08	kA	
		$t = 10\text{ ms}; (50\text{ Hz}), \text{ sine}$	$T_{VJ} = 150^\circ\text{C}$		4.00	kA	
		$t = 8,3\text{ ms}; (60\text{ Hz}), \text{ sine}$	$V_R = 0\text{ V}$		4.32	kA	
$I^2t$	value for fusing	$t = 10\text{ ms}; (50\text{ Hz}), \text{ sine}$	$T_{VJ} = 45^\circ\text{C}$		110.5	kA <sup>2</sup> s	
		$t = 8,3\text{ ms}; (60\text{ Hz}), \text{ sine}$	$V_R = 0\text{ V}$		107.1	kA <sup>2</sup> s	
		$t = 10\text{ ms}; (50\text{ Hz}), \text{ sine}$	$T_{VJ} = 150^\circ\text{C}$		79.8	kA <sup>2</sup> s	
		$t = 8,3\text{ ms}; (60\text{ Hz}), \text{ sine}$	$V_R = 0\text{ V}$		77.5	kA <sup>2</sup> s	
$C_J$	junction capacitance	$V_R = 400\text{ V}; f = 1\text{ MHz}$	$T_{VJ} = 25^\circ\text{C}$		238	pF	



Package Y4				Ratings			
Symbol	Definition	Conditions	min.	typ.	max.	Unit	
$I_{RMS}$	RMS current	per terminal			300	A	
$T_{VJ}$	virtual junction temperature		-40		150	°C	
$T_{op}$	operation temperature		-40		125	°C	
$T_{stg}$	storage temperature		-40		125	°C	
<b>Weight</b>					150	g	
$M_D$	mounting torque		2.25		2.75	Nm	
$M_T$	terminal torque		4.5		5.5	Nm	
$d_{Spp/App}$	creepage distance on surface   striking distance through air	terminal to terminal	14.0	10.0		mm	
$d_{Spb/Apb}$		terminal to backside	16.0	16.0		mm	
$V_{ISOL}$	isolation voltage	t = 1 second			3600	V	
		t = 1 minute	50/60 Hz, RMS; $I_{ISOL} \leq 1$ mA		3000	V	



Data Matrix: part no. (1-19), DC + PI (20-25), lot.no.# (26-31), blank (32), serial no.# (33-36)

Ordering	Ordering Number	Marking on Product	Delivery Mode	Quantity	Code No.
Standard	MDD142-08N1	MDD142-08N1	Box	6	430641

**Equivalent Circuits for Simulation**

\* on die level

$T_{VJ} = 150^{\circ}\text{C}$



**Rectifier**

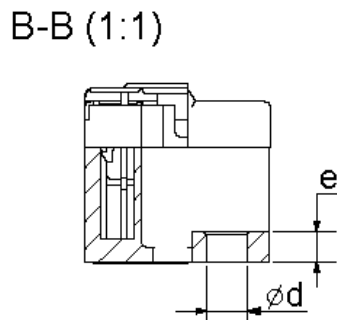
$V_{0\ max}$	threshold voltage	0.8	V
$R_{0\ max}$	slope resistance *	0.7	mΩ



**Outlines Y4**



Dim.	MIN [mm]	MAX [mm]	MIN [inch]	MAX [inch]
a	30.0	30.6	1.181	1.205
b	typ. 0.25		typ. 0.010	
c	64.0	65.0	2.520	2.559
d	6.5	7.0	0.256	0.275
e	4.9	5.1	0.193	0.201
h	93.5	94.5	3.681	3.720
i	79.5	80.5	3.130	3.169
k	33.4	34.0	1.315	1.339
l	16.7	17.3	0.657	0.681
m	22.7	23.3	0.894	0.917
n	22.7	23.3	0.894	0.917
o	14.0	15.0	0.551	0.591
p	typ. 10.5		typ. 0.413	



**Rectifier**

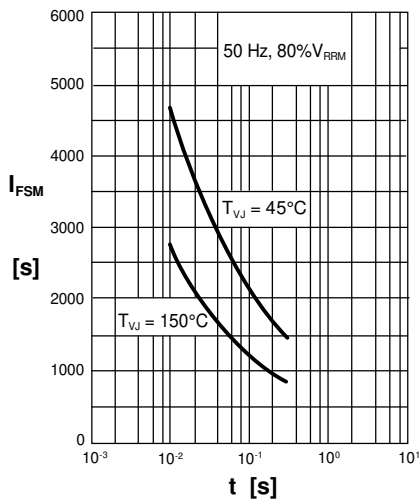


Fig. 1 Surge overload current  
 $I_{FSM}$ : Crest value,  $t$ : duration

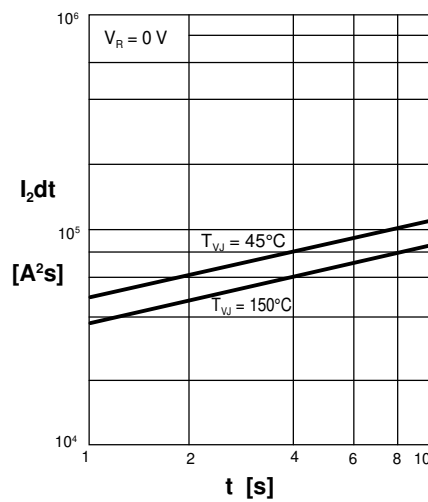


Fig. 2  $I^2dt$  versus time (1-10 ms)

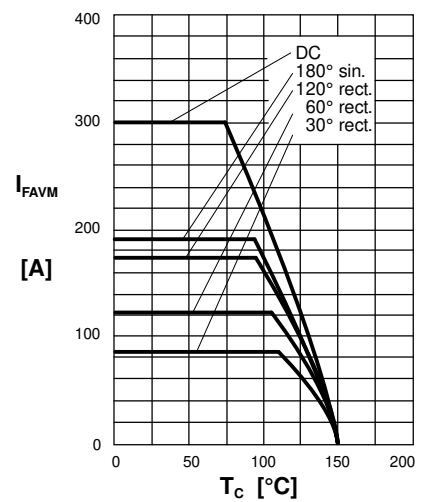


Fig. 2a Maximum forward current at case temperature

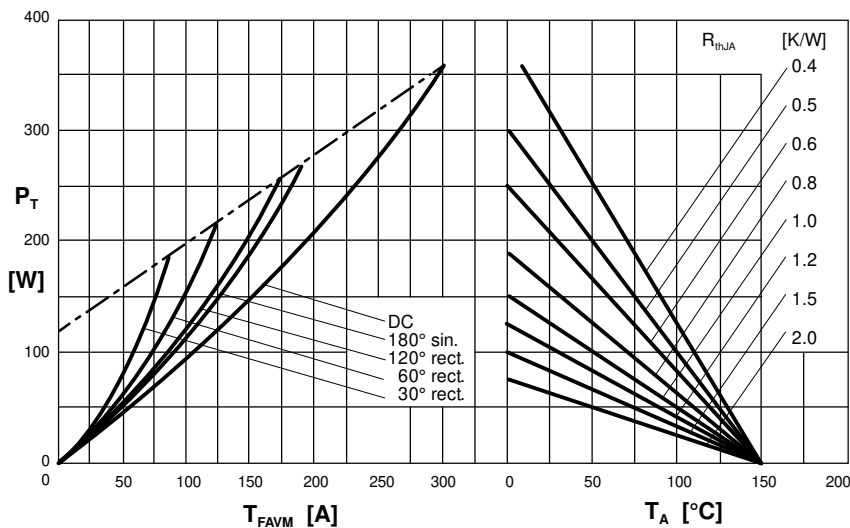


Fig. 3 Power dissipation vs. forward current and ambient temperature (per diode)

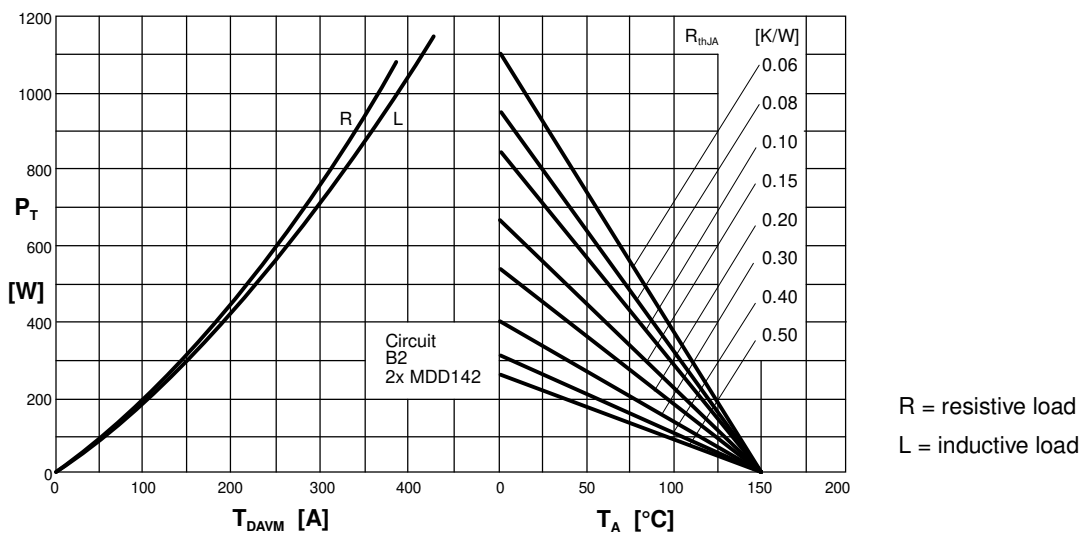


Fig. 4 Single phase rectifier bridge: Power dissipation vs. direct output current and ambient

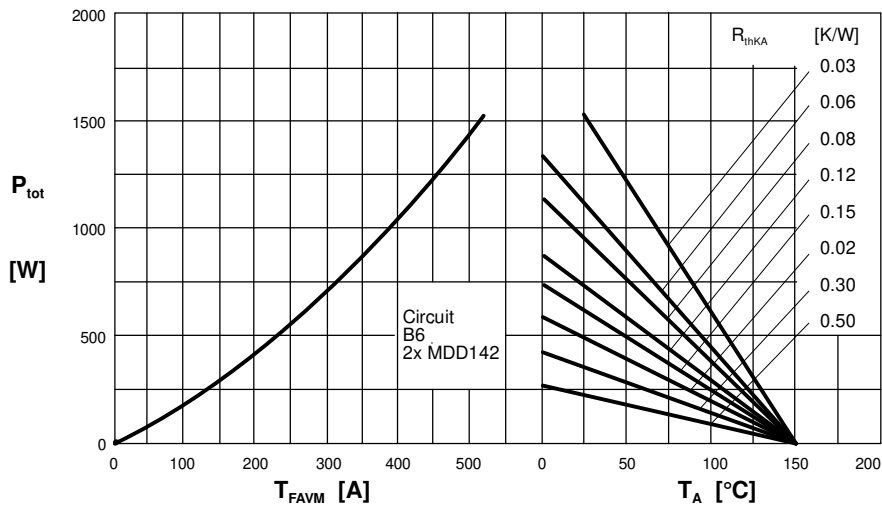
**Rectifier**


Fig. 5 Three phase rectifier bridge: Power dissipation vs. direct output current and ambient temperature

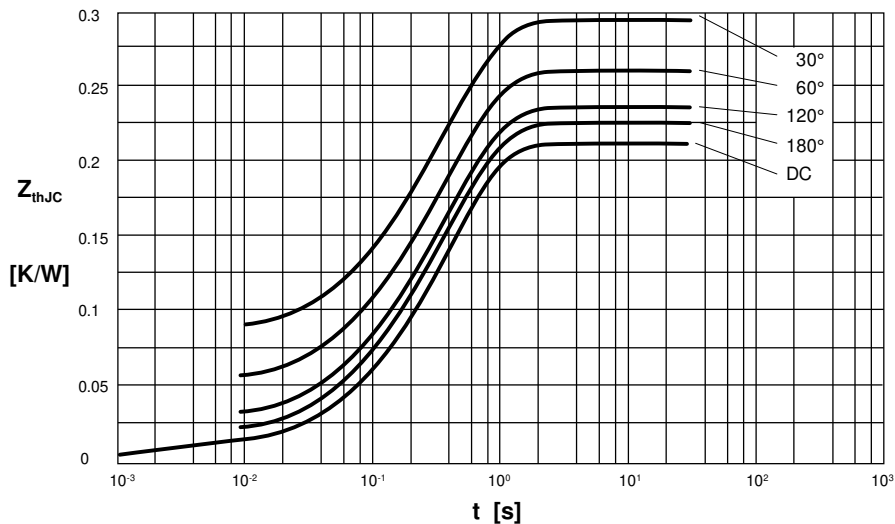


Fig. 6 Transient thermal impedance junction to case (per diode)

$R_{thJC}$  for various conduction angles  $d$ :

$d$	$R_{thJC}$ [K/W]
DC	0.210
180°	0.223
120°	0.233
60°	0.260
30°	0.295

Constants for  $Z_{thJC}$  calculation:

$i$	$R_{thi}$ [K/W]	$t_i$ [s]
1	0.0087	0.001
2	0.0163	0.065
3	0.1850	0.400

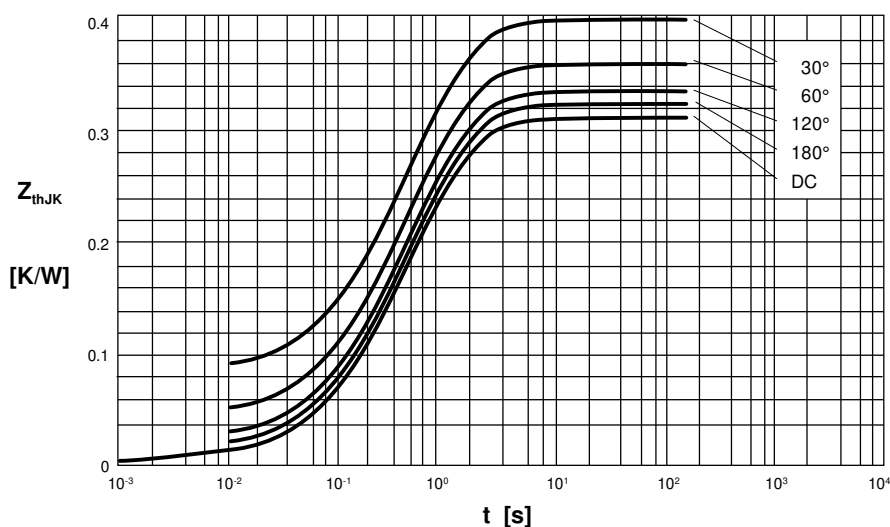


Fig. 7 Transient thermal impedance junction to heatsink (per diode)

$R_{thJK}$  for various conduction angles  $d$ :

$d$	$R_{thJK}$ [K/W]
DC	0.310
180°	0.323
120°	0.333
60°	0.360
30°	0.395

Constants for  $Z_{thJK}$  calculation:

$i$	$R_{thi}$ [K/W]	$t_i$ [s]
1	0.0087	0.001
2	0.0163	0.065
3	0.1850	0.400
4	0.1000	1.290

# Mouser Electronics

Authorized Distributor

Click to View Pricing, Inventory, Delivery & Lifecycle Information:

[IXYS:](#)

[MDD142-08N1](#)