

## RoHS Recast Compliant **SATA-Disk Module**

### SV250-7LP2 BiCS5 Product Specifications

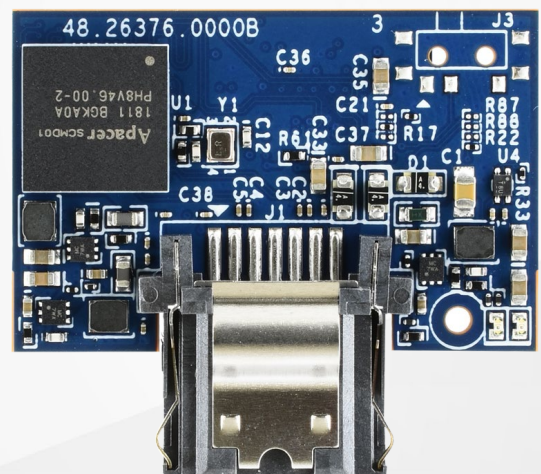

January 5, 2023

Version 1.1



**Apacer Technology Inc.**

1F, No.32, Zhongcheng Rd., Tucheng Dist., New Taipei City, Taiwan, R.O.C

Tel: +886-2-2267-8000 Fax: +886-2-2267-2261

[www.apacer.com](http://www.apacer.com)

## Specifications Overview:

- **Compliance with SATA Revision 3.2**
  - SATA 6 Gb/s
  - ATA-8 command set
  - Backward compatible with SATA 1.5/3 Gb/s
- **Capacity**
  - 120, 240, 480 GB
- **Performance<sup>1</sup>**
  - Burst read/write: 600 MB/sec
  - Sequential read: Up to 560 MB/sec
  - Sequential write: Up to 480 MB/sec
  - Random read (4K): Up to 53,000 IOPS
  - Random write (4K): Up to 68,000 IOPS
- **Flash Management**
  - Low-Density Parity-Check (LDPC) Code
  - Global Wear Leveling
  - Flash bad-block management
  - Flash Translation Layer: Page Mapping
  - S.M.A.R.T.
  - Power Failure Management
  - ATA Secure Erase
  - TRIM
  - Hyper Cache Technology
  - Over-provisioning
  - DataRAID™
  - SMART Read Refresh™
- **Security**
  - AES 256-bit hardware encryption
  - Trusted Computing Group (TCG) Opal 2.0 (optional)
- **NAND Flash Type: 3D TLC (BiCS5)**
- **MTBF: >3,000,000 hours**
- **Endurance (in drive writes per day: DWPD)**
  - 120 GB: 2.02 DWPD
  - 240 GB: 1.99 DWPD
  - 480 GB: 2.07 DWPD
- **Temperature Range**
  - Operating:
    - Standard: 0°C to 70°C
    - Wide: -40°C to 85°C
  - Storage: -55°C to 100°C
- **Supply Voltage**
  - 5.0 V ± 10%
- **Power Consumption<sup>1</sup>**
  - Active mode (Max.): 280 mA
  - Idle mode: 55 mA
- **Power Supply Option: Multi-PowerPath Technology**
  - Cable type: +5V VCC from power cable
  - Cable-less type:
    - Pin 7: +5V VCC from the 7th pin
    - 7+2 Pin: +5V VCC from the 2 metal pins on both sides of the SATA connector
- **Connector Type**
  - 7-pin SATA signal connector
  - Power segment options: 2 metal pins on each side of SATA connector or power cable connector
- **Form Factor**
  - SATA Disk Module: 7-pin/180 degree
  - Dimensions: 33.00 x 29.30 x 9.45, unit: mm
- **Reliability**
  - Thermal Sensor
  - Thermal Throttling (optional)
  - End-to-End Data Protection
- **LED Indicators for Drive Behavior**
- **RoHS Recast Compliant (Complies with 2011/65/EU Standard)**

Note:

1. Varies from capacities. The values for performances and power consumptions presented are typical and may vary depending on flash configurations or platform settings. The term idle refers to the standby state of the device.

## Table of Contents

<b>1. General Description .....</b>	<b>4</b>
<b>2. Functional Block .....</b>	<b>5</b>
<b>3. Pin Assignments.....</b>	<b>6</b>
3.1 Multi-PowerPath Technology.....	6
3.2 Cable Type .....	6
3.3 Cable-Less Type .....	7
<b>4. Product Specifications.....</b>	<b>8</b>
4.1 Capacity.....	8
4.2 Performance .....	8
4.3 Environmental Specifications .....	9
4.4 Mean Time Between Failures (MTBF) .....	9
4.5 Certification and Compliance.....	9
4.6 Endurance .....	10
4.7 LED Indicator Behavior.....	10
<b>5. Flash Management.....</b>	<b>11</b>
5.1 Error Correction/Detection.....	11
5.2 Bad Block Management .....	11
5.3 Global Wear Leveling .....	11
5.4 Flash Translation Layer – Page Mapping.....	11
5.5 TRIM .....	11
5.6 Power Failure Management .....	12
5.7 ATA Secure Erase .....	12
5.8 SATA Power Management.....	12
5.9 Hyper Cache Technology .....	12
5.10 Over-provisioning .....	12
5.11 DataRAID™ .....	13
5.12 SMART Read Refresh™ .....	13
<b>6. Security and Reliability Features .....</b>	<b>14</b>
6.1 Advanced Encryption Standard .....	14
6.2 TCG Opal (optional) .....	14
6.3 Thermal Sensor .....	14
6.4 Thermal Throttling (optional) .....	14

6.5 End-to-End Data Protection.....	15
<b>7. Software Interface .....</b>	<b>16</b>
7.1 Command Set.....	16
7.2 S.M.A.R.T. ....	17
<b>8. Electrical Specifications.....</b>	<b>18</b>
8.1 Operating Voltage.....	18
8.2 Power Consumption .....	18
<b>9. Mechanical Specifications.....</b>	<b>19</b>
<b>10. Product Ordering Information.....</b>	<b>20</b>
10.1 Product Code Designations.....	20
10.2 Valid Combinations.....	21

## 1. General Description

Apacer SV250-7LP2 (SATA Disk Module 7Pin/180 Degree Low Profile 2) is a super-mini industrial SSD module made with rigid and flex boards featuring a hinged design that allows the boards to stack for better flexibility and shock absorption. SV250-7LP2 features Apacer Multi-PowerPath technology that provides three methods to supply power to the host either via a conventional cable or cable-less design via pin7 or state-of-art 7+2 pin connector, which in turn offers developers maximum flexibility when it comes to board design.

SV250-7LP2 utilizes 3D NAND for higher capacity up to 480GB and provides more power efficiency than 2D NAND. Designed in SATA 6 Gb/s interface, SV250-7LP2 can deliver outstanding performance up to 560 MB/s in reading and 480 MB/s in writing, highly suitable to serve as operating system boot drive or storage media of important data. Regarding reliability, SV250-7LP2 is built with a powerful SATA controller that supports on-the-module ECC as well as efficient wear leveling scheme and implemented with LDPC (Low Density Parity Check) ECC engine to extend SSD endurance and increase data reliability. Furthermore, SV250-7LP2 is equipped with a built-in thermal sensor to monitor the temperature of the SSD via S.M.A.R.T health monitoring and configured with thermal throttling to dynamically adjust frequency scaling to enhance data reliability and provide sustained performance while overheating. For highly-intensive applications, End-to-End Data Protection ensures that data integrity can be assured at multiple points in the path to enable reliable delivery of data transfers.

Security-wise, Advanced Encryption Standard (AES) and Trusted Computing Group (TCG) Opal (optional) ensure data security and provide users with peace of mind knowing their data is safeguarded against unauthorized use at all times. SV250-7LP2 adopts the latest page mapping file translation layer and comes with various implementations including power saving modes, wear leveling, flash block management, S.M.A.R.T., TRIM, power failure management, Hyper Cache technology, over-provisioning, DataRAID™ and SMART Read Refresh™.

With exceptional performance, trustable reliability and enhanced data protection, SV250-7LP2 is definitely the ideal storage or cache solution for a variety of applications ranging from industrial, imaging, computing to enterprise markets.

## 2. Functional Block

Apacer SV250-7LP2 includes a single-chip controller and flash media. The controller integrates the flash management unit to support multi-channel, multi-bank flash arrays. Figure 2-1 shows the functional block diagram.

Note: The actual number of NAND flash used on Apacer SV250-7LP2 varies from capacities. The illustration is for reference only.

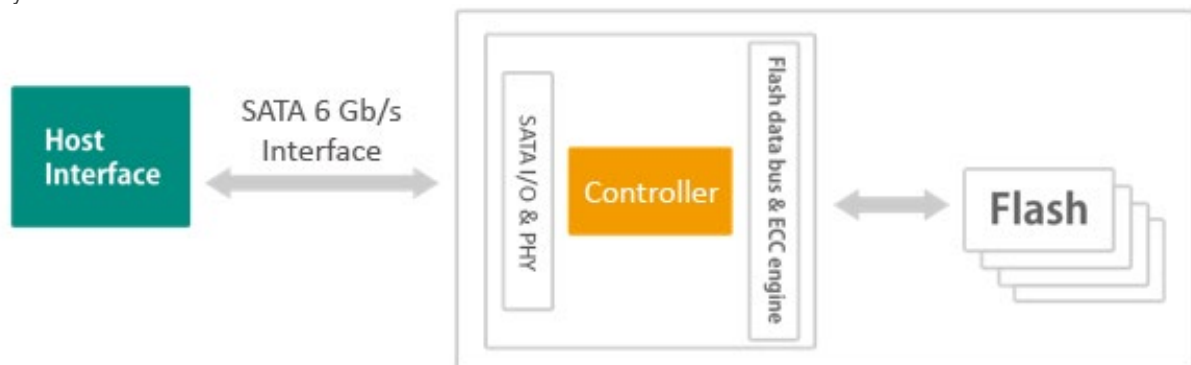

Figure 2-1 Functional Block Diagram

### 3. Pin Assignments

#### 3.1 Multi-PowerPath Technology

Apacer’s patented Multi-PowerPath technology provides a three-option plug-and-play solution for power supply. In addition to using a conventional power cable, power can also be supplied through state-of-art 7+2 pin connector on the side with cable-less design, allowing an SSD to operate without external power supply, giving it the dual advantages of signal integrity and flexible configuration on the motherboard. With the exclusive, innovative power circuit mechanism, Multi-PowerPath protects miniature SSD from being damaged by overheating even when power is concurrently supplied via the three methods.

#### 3.2 Cable Type

+5V VCC from Power Cable

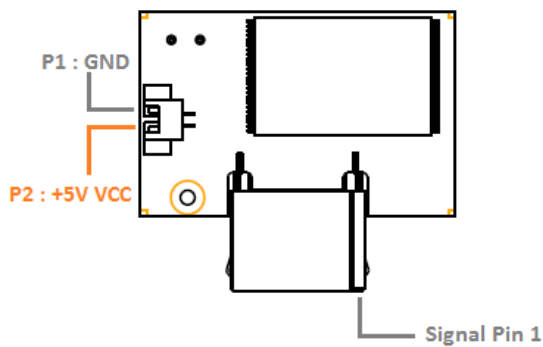

Table 3-1 Signal Segment

Pin	Type	Description
1	GND	Ground
2	A+	Differential Signal Pair A
3	A-	
4	GND	Ground
5	B-	Differential Signal Pair B
6	B+	
7	GND	Ground

Table 3-2 Power Segment

Pin	Type	Description
P1	GND	Ground
P2	VCC	+5V VCC

### 3.3 Cable-Less Type

Pin 7: +5V VCC from the 7th pin

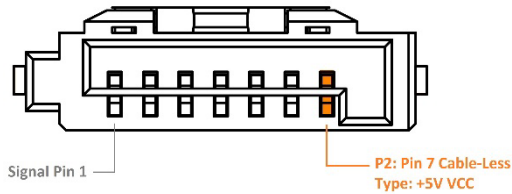

Table 3-3 Signal/Power Segment (Pin 7 Cable-less)

Pin	Type	Description
1	GND	Ground
2	A+	Differential Signal Pair A
3	A-	
4	GND	Ground
S5	B-	Differential Signal Pair B
S6	B+	
P2	<b>VCC</b>	<b>+5V VCC</b>

7+2 Pin: +5V VCC from the 2 metal pins on both sides of the SATA connector

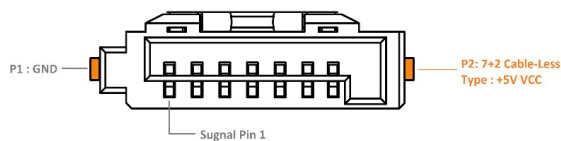

Table 3-4 Signal Segment

Pin	Type	Description
1	GND	Ground
2	A+	Differential Signal Pair A
3	A-	
4	GND	Ground
5	B-	Differential Signal Pair B
6	B+	
7	GND	Ground

Table 3-5 Power Segment (7+2 Cable-less)

Pin	Type	Description
P1	GND	Ground
P2	<b>VCC</b>	<b>+5V VCC</b>



## 4. Product Specifications

### 4.1 Capacity

Capacity specifications of SV250-7LP2 are available as shown in Table 4-1. It lists the specific capacity and the default numbers of heads, sectors and cylinders for each product line.

**Table 4-1 Capacity Specifications**

Capacity	Total bytes	Cylinders	Heads	Sectors	Total LBA
120 GB	120,034,123,776	16,383	16	63	234,441,648
240 GB	240,057,409,536	16,383	16	63	468,862,128
480 GB	480,103,981,056	16,383	16	63	937,703,088

Notes:

- Display of total bytes varies from operating systems.
- 1 GB = 1,000,000,000 bytes; 1 sector = 512 bytes.
- LBA count addressed in the table above indicates total user storage capacity and will remain the same throughout the lifespan of the device. However, the total usable capacity of the SSD is most likely to be less than the total physical capacity because a small portion of the capacity is reserved for device maintenance usages.

### 4.2 Performance

Performance of SV250-7LP2 is listed below in Table 4-2.

**Table 4-2 Performance Specifications**

Capacity	120 GB	240 GB	480 GB
<b>Sequential Read (MB/s)</b>	430	560	560
<b>Sequential Write (MB/s)</b>	190	480	480
<b>4K Random Read (IOPS)</b>	15,000	35,000	53,000
<b>4K Random Write (IOPS)</b>	44,000	68,000	64,000

Notes:

- Results may differ from various flash configurations or host system setting.
- Sequential read/write is based on CrystalDiskMark 8.0.4 with file size 1,000MB.
- Random read/write is measured using IOMeter with Queue Depth 32.

### 4.3 Environmental Specifications

Environmental specifications of SV250-7LP2 product are shown in Table 4-3.

**Table 4-3 Environmental Specifications**

Parameter	Type	Specifications
Temperature	Operating	0°C to 70°C (Standard); -40°C to 85°C (Wide)
	Non-operating	-55°C to 100°C
Vibration	Operating	7.69 GRMS, 20~2000 Hz/random (compliant with MIL-STD-810G)
	Non-operating	4.02 GRMS, 15~2000 Hz/random (compliant with MIL-STD-810G)
Shock	Operating	Acceleration, 50(G)/11(ms)/half sine (compliant with MIL-STD-202G)
	Non-operating	Acceleration, 1500(G)/0.5(ms)/half sine (compliant with MIL-STD-883K)

Note: This Environmental Specification table indicates the conditions for testing the device. Real world usages may affect the results.

### 4.4 Mean Time Between Failures (MTBF)

Mean Time Between Failures (MTBF) is predicted based on reliability data for the individual components in SV250-7LP2. The prediction result for SV250-7LP2 is more than 3,000,000 hours.

Note: The MTBF is predicated and calculated based on “Telcordia Technologies Special Report, SR-332, Issue 3” method.

### 4.5 Certification and Compliance

SV250-7LP2 complies with the following standards:

- CE
- UKCA
- FCC
- RoHS Recast
- MIL-STD-810G

## 4.6 Endurance

The endurance of a storage device is predicted by Drive Writes Per Day based on several factors related to usage, such as the amount of data written into the drive, block management conditions, and daily workload for the drive. Thus, key factors, such as Write Amplifications and the number of P/E cycles, can influence the lifespan of the drive.

**Table 4-4 Endurance Specifications**

Capacity	Drive Writes Per Day
120 GB	2.02
240 GB	1.99
480 GB	2.07

**Notes:**

- This estimation complies with JEDEC JESD-219, enterprise endurance workload of random data with payload size distribution.
- Flash vendor guaranteed 3D NAND TLC P/E cycle: 3K
- WAF may vary from capacity, flash configurations and writing behavior on each platform.
- 1 Terabyte = 1,024GB
- DWPD (Drive Writes Per Day) is calculated based on the number of times that user overwrites the entire capacity of an SSD per day of its lifetime during the warranty period. (3D NAND TLC warranty: 3 years)

## 4.7 LED Indicator Behavior

The behavior of the SV250-7LP2 LED indicators is described in Table 4-5.

**Table 4-5 LED Behavior**

Location	LED	Description
LED A	DAS	LED blinks when the drive is being accessed
LED B	Power	LED glows solidly when power is on

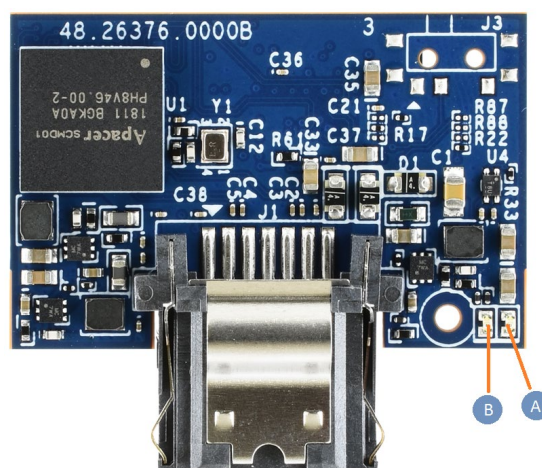

## 5. Flash Management

### 5.1 Error Correction/Detection

SV250-7LP2 implements a hardware ECC scheme, based on the Low Density Parity Check (LDPC). LDPC is a class of linear block error correcting code which has apparent coding gain over BCH code because LDPC code includes both hard decoding and soft decoding algorithms. With the error rate decreasing, LDPC can extend SSD endurance and increase data reliability while reading raw data inside a flash chip.

### 5.2 Bad Block Management

Current production technology is unable to guarantee total reliability of NAND flash memory array. When a flash memory device leaves factory, it comes with a minimal number of initial bad blocks during production or out-of-factory as there is no currently known technology that produce flash chips free of bad blocks. In addition, bad blocks may develop during program/erase cycles. Since bad blocks are inevitable, the solution is to keep them in control. Apacer flash devices are programmed with ECC, page mapping technique and S.M.A.R.T to reduce invalidity or error. Once bad blocks are detected, data in those blocks will be transferred to free blocks and error will be corrected by designated algorithms.

### 5.3 Global Wear Leveling

Flash memory devices differ from Hard Disk Drives (HDDs) in terms of how blocks are utilized. For HDDs, when a change is made to stored data, like erase or update, the controller mechanism on HDDs will perform overwrites on blocks. Unlike HDDs, flash blocks cannot be overwritten and each P/E cycle wears down the lifespan of blocks gradually. Repeatedly program/erase cycles performed on the same memory cells will eventually cause some blocks to age faster than others. This would bring flash storages to their end of service term sooner. Global wear leveling is an important mechanism that levels out the wearing of all blocks so that the wearing-down of all blocks can be almost evenly distributed. This will increase the lifespan of SSDs.

### 5.4 Flash Translation Layer – Page Mapping

Page mapping is an advanced flash management technology whose essence lies in the ability to gather data, distribute the data into flash pages automatically, and then schedule the data to be evenly written. Page-level mapping uses one page as the unit of mapping. The most important characteristic is that each logical page can be mapped to any physical page on the flash memory device. This mapping algorithm allows different sizes of data to be written to a block as if the data is written to a data pool and it does not need to take extra operations to process a write command. Thus, page mapping is adopted to increase random access speed and improve SSD lifespan, reduce block erase frequency, and achieve optimized performance and lifespan.

### 5.5 TRIM

TRIM is a SATA command that helps improve the read/write performance and efficiency of solid-state drives (SSD). The command enables the host operating system to inform SSD controller which blocks contain invalid data, mostly because of the erase commands from host. The invalid will be discarded permanently and the SSD will retain more space for itself.

## 5.6 Power Failure Management

Power Failure Management plays a crucial role when power supply becomes unstable. Power disruption may occur when users are storing data into the SSD, leading to instability in the drive. However, with Power Failure Management, a firmware protection mechanism will be activated to scan pages and blocks once power is resumed. Valid data will be transferred to new blocks for merging and the mapping table will be rebuilt. Therefore, data reliability can be reinforced, preventing damage to data stored in the NAND Flash.

## 5.7 ATA Secure Erase

ATA Secure Erase is an ATA disk purging command currently embedded in most of the storage drives. Defined in ATA specifications, (ATA) Secure Erase is part of Security Feature Set that allows storage drives to erase all user data areas. The erase process usually runs on the firmware level as most of the ATA-based storage media currently in the market are built-in with this command. ATA Secure Erase can securely wipe out the user data in the drive and protects it from malicious attack.

## 5.8 SATA Power Management

By complying with SATA 6 Gb/s specifications, the SSD supports the following SATA power saving modes:

- ACTIVE: PHY ready, full power, TX & RX operational
- PARTIAL: Reduces power, resumes in under 10  $\mu$ s (microseconds)
- SLUMBER: Reduces power, resumes in under 10 ms (milliseconds)
- HIPM: Host-Initiated Power Management
- DIPM: Device-Initiated Power Management
- AUTO-SLUMBER: Automatic transition from partial to slumber.

Note: The behaviors of power management features would depend on host/device settings.

## 5.9 Hyper Cache Technology

Apacer proprietary Hyper Cache technology uses a portion of the available capacity as SLC (1bit-per-cell) NAND flash memory, called Hyper cache mode. When data is written to SSD, the firmware will direct the data to Hyper Cache mode, providing excellent performance to handle various scenarios in industrial use.

## 5.10 Over-provisioning

Over-provisioning (OP) is a certain portion of the SSD capacity exclusively for increasing Garbage Collection (GC) efficiency, especially when the SSD is filled to full capacity or performs a heavy mixed-random workload. OP has the advantages of providing extended life expectancy, reliable data integrity, and high sustained write performance.

## 5.11 DataRAID™

Apacer's DataRAID algorithm applies an additional level of protection and error-checking. Using this algorithm, a certain amount of space is given over to aggregating and resaving the existing parity data used for error checking. So, in the event that data becomes corrupted, the parity data can be compared to the existing uncorrupted data and the content of the corrupted data can be rebuilt.

## 5.12 SMART Read Refresh™

Apacer's SMART Read Refresh plays a proactive role in avoiding read disturb errors from occurring to ensure health status of all blocks of NAND flash. Developed for read-intensive applications in particular, SMART Read Refresh is employed to make sure that during read operations, when the read operation threshold is reached, the data is refreshed by re-writing it to a different block for subsequent use.

## 6. Security and Reliability Features

### 6.1 Advanced Encryption Standard

Advanced Encryption Standard (AES) is a specification for the encryption of electronic data. AES has been adopted by the U.S. government since 2001 to protect classified information and is now widely implemented in embedded computing applications. The AES algorithm used in software and hardware is symmetric so that encrypting/decrypting requires the same encryption key. Without the key, the encrypted data is inaccessible to ensure information security.

Notably in flash memory applications, AES 256-bit hardware encryption is the mainstream to protect sensitive or confidential data. The hardware encryption provides better performance, reliability, and security than software encryption. It uses a dedicated processor, which is built inside the controller, to process the encryption and decryption. This enormously shortens the processing time and makes it efficient.

### 6.2 TCG Opal (optional)

Developed by the Trusted Computing Group (TCG), an organization whose members work together to formulate industry standards, Opal is a set of security specifications used for applying hardware-based encryption to storage devices.

Hardware encryption has many advantages. First of all, it transfers the computational load of the encryption process to dedicated processors, reducing the stress on the host system's CPU. In addition, storage devices complying with Opal specifications are self-encryption devices. Opal specifications also feature boot authentication. When the drive is being accessed, the shadow MBR will request the drive password at boot. The drive will only unlock and decrypt if the correct password is supplied. The other feature is LBA-specific permissions. Users are assigned different permissions for LBA ranges created by the device administrator. Each LBA range is password-protected and can only be accessed by users with the correct key to perform permitted actions (read/write/erase).

### 6.3 Thermal Sensor

Apacer Thermal Sensor is a digital temperature sensor with serial interface. By using designated pins for transmission, storage device owners are able to read temperature data.

### 6.4 Thermal Throttling (optional)

Thermal throttling can monitor the temperature of the SSD equipped with a built-in thermal sensor via S.M.A.R.T. commands. This method can ensure the temperature of the device stays within temperature limits by drive throttling, i.e. reducing the speed of the drive when the device temperature reaches the threshold level, so as to prevent overheating, guarantee data reliability, and prolong product lifespan. When the temperature exceeds the maximum threshold level, thermal throttling will be triggered to reduce performance step by step to prevent hardware components from being damaged. Performance is only permitted to drop to the extent necessary for recovering a stable temperature to cool down the device's temperature. Once the temperature decreases to the minimum threshold value, transfer speeds will rise back to its optimum performance level.

## 6.5 End-to-End Data Protection

End-to-End Data Protection is a feature implemented in Apacer SSD products that extends error control to cover the entire path from the host computer to the drive and back, and ensure data integrity at multiple points in the path to enable reliable delivery of data transfers. Unlike ECC which does not exhibit the ability to determine the occurrence of errors throughout the process of data transmission, End-to-End Data Protection allows SSD controller to identify an error created anywhere in the path and report the error to the host computer before it is written to the drive. This error-checking and error-reporting mechanism therefore guarantees the trustworthiness and reliability of the SSD.



## 7. Software Interface

### 7.1 Command Set

This section defines the software requirements and the format of the commands the host sends to SV250-7LP2. Commands are issued to SV250-7LP2 by loading the required registers in the command block with the supplied parameters, and then writing the command code to the Command register.

**Table 7-1 Command Set**

Code	Command	Code	Command
E5h	CHECK POWER MODE	F4h	SECURITY ERASE UNIT
06h	DATA SET MANAGEMENT	F5h	SECURITY FREEZE LOCK
92h	DOWNLOAD MICROCODE	F1h	SECURITY SET PASSWORD
90h	EXECUTE DEVICE DIAGNOSTIC	F2h	SECURITY UNLOCK
E7h	FLUSH CACHE	70h	SEEK
EAh	FLUSH CACHE EXT	EFh	SET FEATURES
ECh	IDENTIFY DEVICE	C6h	SET MULTIPLE MODE
E3h	IDLE	E6h	SLEEP
E1h	IDLE IMMEDIATE	B0h	SMART
91h	INITIALIZE DEVICE PARAMETERS	E2h	STANDBY
E4h	READ BUFFER	E0h	STANDBY IMMEDIATE
C8h	READ DMA	E8h	WRITE BUFFER
25h	READ DMA EXT	CAh	WRITE DMA
60h	READ FPDMA QUEUED	35h	WRITE DMA EXT
C4h	READ MULTIPLE	3Dh	WRITE DMA FUA EXT
29h	READ MULTIPLE EXT	61h	WRITE FPDMA QUEUED
2Fh	READ LOG EXT	3Fh	WRITE LOG EXT
47h	READ LOG DMA EXT	57h	WRITE LOG DMA EXT
20h	READ SECTOR	C5h	WRITE MULTIPLE
24h	READ SECTOR EXT	39h	WRITE MULTIPLE EXT
40h	READ VERIFY SECTORS	CEh	WRITE MULTIPLE FUA EXT
42h	READ VERIFY SECTORS EXT	30h	WRITE SECTOR
10h	RECALIBRATE	34h	WRITE SECTOR EXT
F6h	SECURITY DISABLE PASSWORD	45h	WRITE UNCORRECTABLE EXT
F3h	SECURITY ERASE PREPARE		

**Table 7-2 Trusted Computing Feature Set**

Code	Command	Code	Command
5Ch	TRUSTED RECEIVE	5Eh	TRUSTED SEND
5Dh	TRUSTED RECEIVE DMA	5Fh	TRUSTED SEND DMA

Note: This feature set is only applicable to products implemented with AES and Opal functions.

## 7.2 S.M.A.R.T.

SMART, an acronym for Self-Monitoring, Analysis and Reporting Technology, is an open standard that allows a hard disk drive to automatically detect its health and report potential failures. When a failure is recorded by SMART, users can choose to replace the drive to prevent unexpected outage or data loss. Moreover, SMART can inform users of impending failures while there is still time to perform proactive actions, such as copy data to another device.

**Table 7-3 SMART Subcommand Set**

Code	SMART Subcommand
D0h	READ DATA
D1h	READ ATTRIBUTE THRESHOLDS
D2h	ENABLE/DISABLE ATTRIBUTE AUTOSAVE
D4h	EXECUTE OFF-LINE IMMEDIATE
D5h	SMART READ LOG
D6h	SMART WRITE LOG
D8h	ENABLE OPERATIONS
D9h	DISABLE OPERATIONS
DAh	RETURN STATUS

**Table 7-4 General SMART Attribute Structure**

Byte	Description
0	ID (Hex)
1 – 2	Status Flag
3	Value
4	Worst
5*-11	Raw Data

\*Byte 5: LSB

**Table 7-5 SMART Attribute ID List**

ID (Hex)	Attribute Name
9 (0x09)	Power-on Hours
12 (0x0C)	Power Cycle Count
163 (0xA3)	Maximum Erase Count
164 (0xA4)	Average Erase Count
166 (0xA6)	Total Later Bad Block Count
167 (0xA7)	SSD Protect Mode (Vendor Specific)
168 (0xA8)	SATA PHY Error Count
171 (0xAB)	Program Fail Count
172 (0xAC)	Erase Fail Count
175 (0xAF)	Bad Cluster Table Count
192 (0xC0)	Unexpected Power Loss Count
194 (0xC2)	Temperature
231 (0xE7)	Lifetime Left
241 (0xF1)	Total Sectors of Write

## 8. Electrical Specifications

### 8.1 Operating Voltage

Table 8-1 lists the supply voltage for SV250-7LP2.

**Table 8-1 Operating Range**

Item	Range
Supply Voltage	5V $\pm$ 10%

### 8.2 Power Consumption

Table 8-2 lists the power consumption for SV250-7LP2.

**Table 8-2 Power Consumption (Unit: mA)**

Mode \ Capacity	120 GB	240 GB	480 GB
<b>Active (Max.)</b>	220	265	280
<b>Idle</b>	55	55	55

Notes:

- All values are typical and may vary depending on flash configurations or host system settings.
- Power consumption is measured using CrystalDiskMark 8.0.4.

## 9. Mechanical Specifications

Table 9-1 Dimensions

Parameter	Unit	120 GB	240 GB	480 GB
Length	mm	33.00 ± 0.15		
Width		29.30 ± 0.30		
Height		9.45		

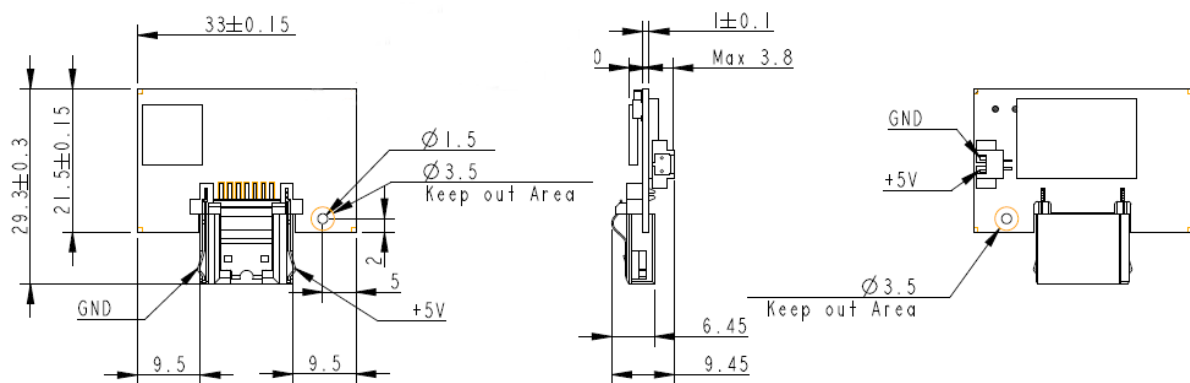

Figure 9-1 Physical Dimensions

## 10. Product Ordering Information

### 10.1 Product Code Designations

Apacer's SV250-7LP2 SSD is available in different configurations and densities. See the chart below for a comprehensive list of options for the SV250-7LP2 series devices.

Code	1	2	3	4	5	6	7	8	9	10	11	12	13	14	15	16
	A	C	2	.	X	X	5	X	X	F	.	X	X	X	X	X

<b>Code 1-3 (Product Line &amp; Form Factor)</b>	SATA SDM7
<b>Code 5-6 (Model/Solution)</b>	25: SV250 A1: SV250 with TCG Opal
<b>Code 7-8 (Product Capacity)</b>	5H: 120GB 5J: 240GB 5K: 480GB
<b>Code 9 (Flash Type &amp; Product Temp)</b>	G: 3D TLC Standard Temperature H: 3D TLC Wide Temperature
<b>Code 10 (Product Spec)</b>	180D LP2 series without housing
<b>Code 12-14 (Version Number)</b>	Random numbers generated by system
<b>Code 15-16 (Firmware Version)</b>	EL: Thermal Sensor OP for Standard Temperature ED: Thermal Sensor OP for Wide Temperature EG: Thermal Sensor TCG Opal OP Standard Temp EA: Thermal Sensor TCG Opal OP Wide Temp

## 10.2 Valid Combinations

The following table lists the available models of the SV250-7LP2 series which are in mass production or will be in mass production. Consult your Apacer sales representative to confirm availability of valid combinations and to determine availability of new combinations.

### 10.2.1 Without TCG Opal

Capacity	Standard Temperature	Wide Temperature
120GB	AC2.255HGF.005EL	AC2.255HHF.003ED
240GB	AC2.255JGF.005EL	AC2.255JHF.003ED
480GB	AC2.255KGF.002EL	AC2.255KHF.001ED

### 10.2.2 With TCG Opal

Capacity	Standard Temperature	Wide Temperature
120GB	AC2.A15HGF.002EG	AC2.A15HHF.002EA
240GB	AC2.A15JGF.002EG	AC2.A15JHF.002EA
480GB	AC2.A15KGF.001EG	AC2.A15KHF.001EA

## Revision History

Revision	Description	Date
1.0	Initial release	10/5/2022
1.1	<ul style="list-style-type: none"><li>- Added TCG Opal support</li><li>- Updated shock specification at Table 4-3</li><li>- Added UKCA to 4.5 Certification and Compliance</li><li>- Removed DataDefender support and replaced it with Power Failure Management</li></ul>	1/5/2023

## Global Presence

### Taiwan (Headquarters)

#### Apacer Technology Inc.

1F., No.32, Zhongcheng Rd., Tucheng Dist.,  
New Taipei City 236, Taiwan R.O.C.  
Tel: 886-2-2267-8000  
Fax: 886-2-2267-2261  
[amtsales@apacer.com](mailto:amtsales@apacer.com)

### U.S.A.

#### Apacer Memory America, Inc.

46732 Lakeview Blvd., Fremont, CA 94538  
Tel: 1-408-518-8699  
Fax: 1-510-249-9551  
[sa@apacerus.com](mailto:sa@apacerus.com)

### Japan

#### Apacer Technology Corp.

6F, Daiyontamachi Bldg., 2-17-12, Shibaura, Minato-Ku,  
Tokyo, 108-0023, Japan  
Tel: 81-3-5419-2668  
Fax: 81-3-5419-0018  
[jpservices@apacer.com](mailto:jpservices@apacer.com)

### Europe

#### Apacer Technology B.V.

Science Park Eindhoven 5051 5692 EB Son,  
The Netherlands  
Tel: 31-40-267-0000  
Fax: 31-40-290-0686  
[sales@apacer.nl](mailto:sales@apacer.nl)

### China

#### Apacer Electronic (Shanghai) Co., Ltd

Room D, 22/FL, No.2, Lane 600, JieyunPlaza,  
Tianshan RD, Shanghai, 200051, China  
Tel: 86-21-6228-9939  
Fax: 86-21-6228-9936  
[sales@apacer.com.cn](mailto:sales@apacer.com.cn)

### India

#### Apacer Technologies Pvt Ltd,

1874, South End C Cross, 9<sup>th</sup> Block Jayanagar,  
Bangalore-560069, India  
Tel: 91-80-4152-9061/62  
Fax: 91-80-4170-0215  
[sales\\_india@apacer.com](mailto:sales_india@apacer.com)



# Mouser Electronics

Authorized Distributor

Click to View Pricing, Inventory, Delivery & Lifecycle Information:

[Apacer:](#)

[AC2.255HGF.005EL](#) [AC2.255HHF.003ED](#) [AC2.255JGF.005EL](#) [AC2.255JHF.003ED](#) [AC2.255KGF.002EL](#)  
[AC2.255KHF.001ED](#)