

Description	Material	Finish
Body	Brass	Nickel
Pin	Brass	Gold
Insulation	PTFE	N/A
Washer	Brass	Nickel
Nut	Brass	Nickel

REVISIONS			
REV	DESCRIPTION	DATE	APPV
B	Updated footprint and dimensions; Added new title block	29-JUN-12	SAH

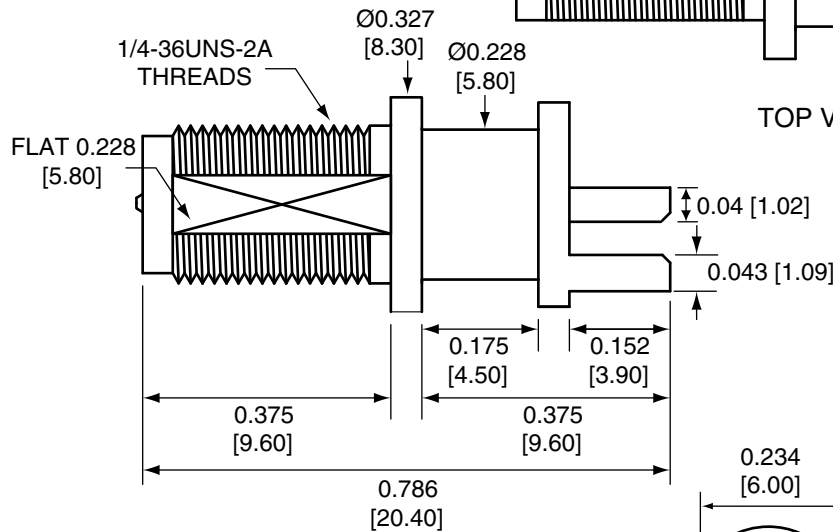

TOP VIEW

SIDE VIEW

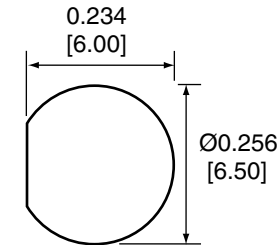

RECOMMENDED MOUNTING HOLE

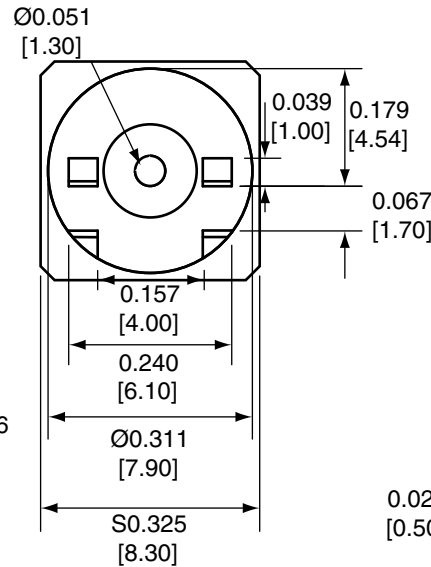

BACK VIEW

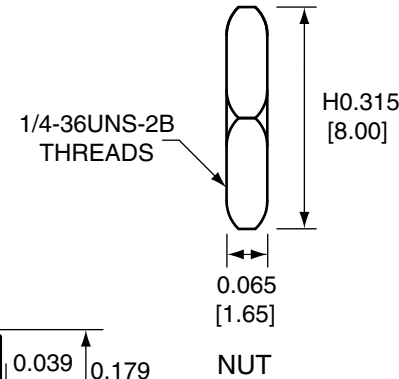

NUT

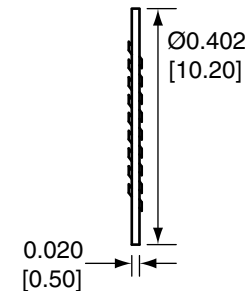

WASHER

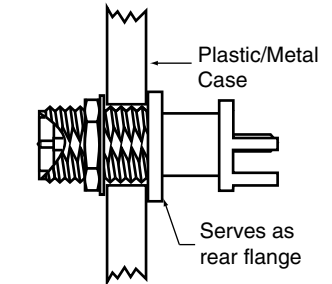
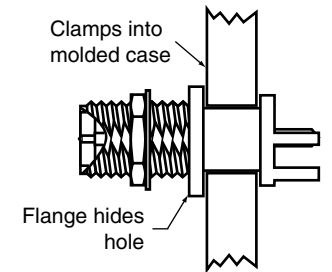
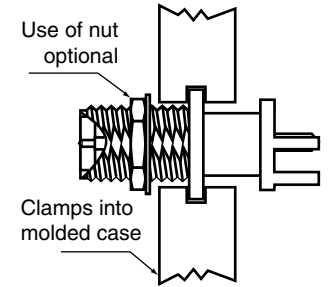

MOUNTING METHODS

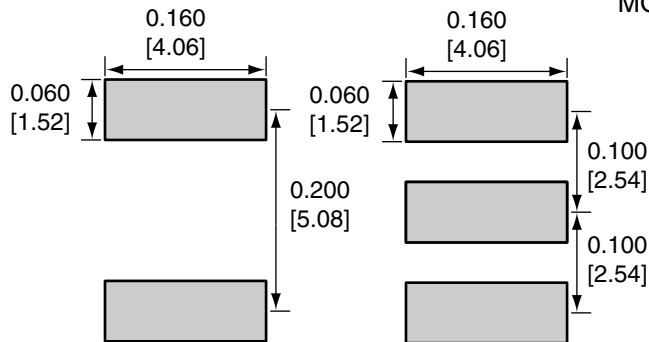

BOTTOM

TOP

RECOMMENDED FOOTPRINT

NOTES: (UNLESS OTHERWISE SPECIFIED)

1. ALL DIMENSIONS ARE IN INCHES [mm].
2. DIMENSIONS APPLY AFTER FINISHING.
3. MANUFACTURE TO BE COMPLIANT WITH EU RoHS DIRECTIVE.
4. SAFETY BREAK ALL SHARP CORNERS AND EDGES .02 MAXIMUM.

WARNING: THIS DRAWING CONTAINS PROPRIETARY INFORMATION THAT IS THE SOLE PROPERTY OF LINX TECHNOLOGIES, AND SHALL BE TREATED AS SUCH. NO DISCLOSURE OR REPRODUCTION OF THIS DOCUMENT IS PERMITTED, IN WHOLE OR IN PART, WITHOUT THE EXPRESS WRITTEN PERMISSION OF LINX TECHNOLOGIES OR ITS DESIGNATED AGENTS.

MATERIAL:	TOLERANCES: .020 [0.50]-.200 [5.00]= ±.008 [0.20] .200 [5.00]-1.200 [30.00]= ±.016 [0.40] 1.20 [30.0]-4.75 [120.0]= ±.024 [0.60] 4.75 [120.0]-12.40 [315.0]= ±.040 [1.0]	PROJECTION: 
FINISH:	DRAWN: B.MURPHY	DT: 29-JUN-12
	ENGR: S.HOGAN	DT: 29-JUN-12

<b>Linx</b>		159 ORT LANE MERLIN, OR 97532	
TITLE: RP-SMA FEMALE EDGE MULTI-MOUNT W/ SQUARE FLANGE FOR 0.062" THICK BOARD			
SIZE <b>A</b>	DWG. NO. CONREVSMA006.062SQ	REV <b>B</b>	
SCALE: 2:1	DO NOT SCALE DRAWING	SHEET 1 OF 1	

# Mouser Electronics

Authorized Distributor

Click to View Pricing, Inventory, Delivery & Lifecycle Information:

[Linx Technologies:](#)

[CONREVSMA006.062SQ](#)