

Description	Material	Finish
Body	Brass	Nickel
Pin	Be Cu	Gold
Insulation	PTFE	N/A
Spacer	PTFE	N/A
Gasket	Si Rubber	N/A
Support	Be Cu	Gold
Heat Shrink	Polyolefin	Black

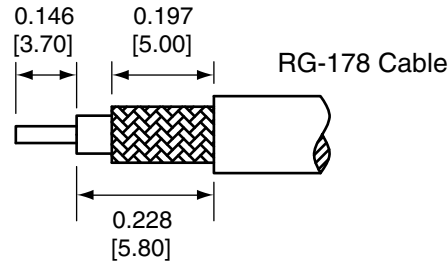

RECOMMENDED CABLE STRIPPING DIMENSIONS

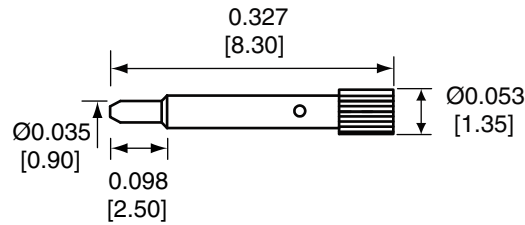
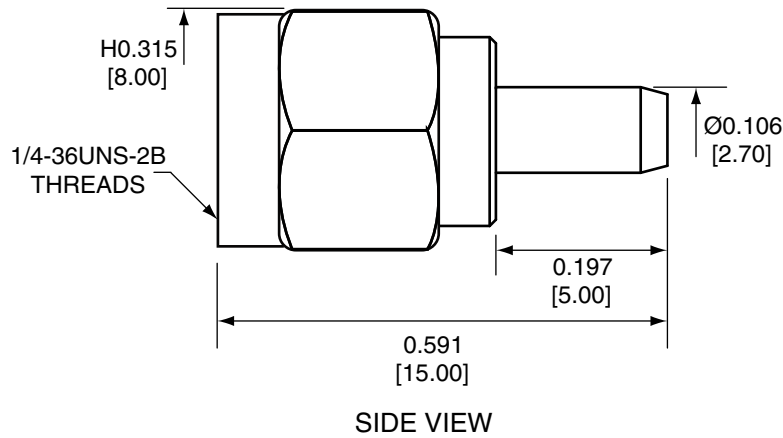

PIN

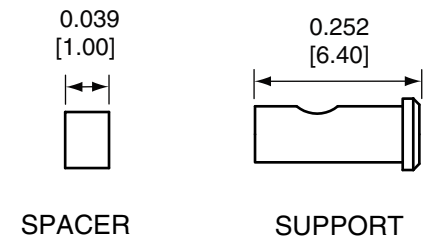

SPACER

SUPPORT

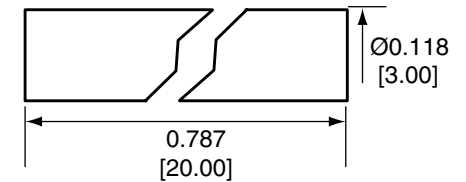

HEAT SHRINK

REVISIONS			
REV	DESCRIPTION	DATE	APPV
B	Updated footprint and dimensions; Added new title block	2-JUL-12	SAH
C	Updated stripping dimensions; Added dimensions to spacer and support	12-JUN-13	SAH

CONSMSA007-R178 ASSEMBLY INSTRUCTIONS

- Strip cable to recommended dimensions.
- Slip heat shrink onto cable.
- Solder support onto the braid.
- Place the spacer onto the center conductor.
- Solder or crimp the pin onto the center conductor.
- Insert the pin, center conductor, spacer and support into the body until the top of the socket is even with the threaded opening in the body.
- Crimp the tail of the body onto the support with a 0.093" hex crimp tool (or one labeled for use with RG-178 cable).
- Use heat shrink to cover crimp.

NOTES: (UNLESS OTHERWISE SPECIFIED)

- ALL DIMENSIONS ARE IN INCHES [mm].
- DIMENSIONS APPLY AFTER FINISHING.
- MANUFACTURE TO BE COMPLIANT WITH EU RoHS DIRECTIVE.
- SAFETY BREAK ALL SHARP CORNERS AND EDGES .02 MAXIMUM.

WARNING: THIS DRAWING CONTAINS PROPRIETARY INFORMATION THAT IS THE SOLE PROPERTY OF LINX TECHNOLOGIES, AND SHALL BE TREATED AS SUCH. NO DISCLOSURE OR REPRODUCTION OF THIS DOCUMENT IS PERMITTED, IN WHOLE OR IN PART, WITHOUT THE EXPRESS WRITTEN PERMISSION OF LINX TECHNOLOGIES OR ITS DESIGNATED AGENTS.

MATERIAL:	TOLERANCES: .020 [0.50]-.200 [5.00]= ±.008 [0.20] .200 [5.00]-1.200 [30.00]= ±.016 [0.40] 1.20 [30.0]-4.75 [120.0]= ±.024 [0.60] 4.75 [120.0]-12.40 [315.0]= ±.040 [1.0]	PROJECTION: 
FINISH:	DRAWN: B.MURPHY	DT: 2-JUL-12
	ENGR: S.HOGAN	DT: 2-JUL-12

		159 ORT LANE MERLIN, OR 97532	
TITLE: SMA MALE CABLE END CRIMP FOR RG-178 CABLE			
SIZE <b>A</b>	DWG. NO. CONSMSA007-R178	REV <b>C</b>	
SCALE: 2:1	DO NOT SCALE DRAWING	SHEET 1 OF 1	

# Mouser Electronics

Authorized Distributor

Click to View Pricing, Inventory, Delivery & Lifecycle Information:

[Linx Technologies:](#)

[CONSMA007-R178](#)