

SUMMARY

Wires

Low voltage 6



Image is for illustrative purpose only

Series	1P
Termination type	Female solder
IP rating	50
AWG wire size	0.00 - 26.00
Cable Ø	4.00 - 5.20 mm
Status	active
Matching parts	PAC.M0.6GL.AC52GZ

Download

[Request a quote](#)

[Catalog](#)

TECHNICAL DETAILS

Mechanics

Shell Style/Model	PR*: Free receptacle with cable collet and nut for fitting a bend relief
Keying	2 keys (alpha=80; Plug: male contacts; Receptacle: female contacts)
Housing Material	PSU (Polysulfone), gray
Variant	G : Gray collet nut for bend relief
Weight	4.51 g

Performance

Configuration	1P.M06 : 6 Low Voltage
Insulator	L: PEEK (UL 94 / V-0/1.5)
Rated Current	6 Amps

Specifications

Contact Type:	Solder
Contact Dia.:	0.7 mm (0.0275in)
Bucket Dia.:	0.6 mm (0.024in)
Max. Solid Conductor:	0.14 mm ² (AWG 26)
Max. Stranded Conductor:	0.14 mm ² (AWG 26)
R (max):	6.5 mOhm
Test voltage (kV rms) Contact-contact:	1.05

LEMO products and services are provided "as is". LEMO makes no warranties or representations with regard to LEMO product & services or use of them, express, implied or statutory, including for accuracy, completeness, or security. The user is fully responsible for his products and applications using LEMO components.

Air clearance min.: 0.85 mm
Creepage distance min.: 0.85 mm

Others

Endurance (Shell): >2000 mating cycles
Temp (min / max): -50°C / +150°C
F ret (min): 50 N
F ret (max): 150 N
Steam sterilization: > 100 times (with potting on rear connection)

DRAWINGS

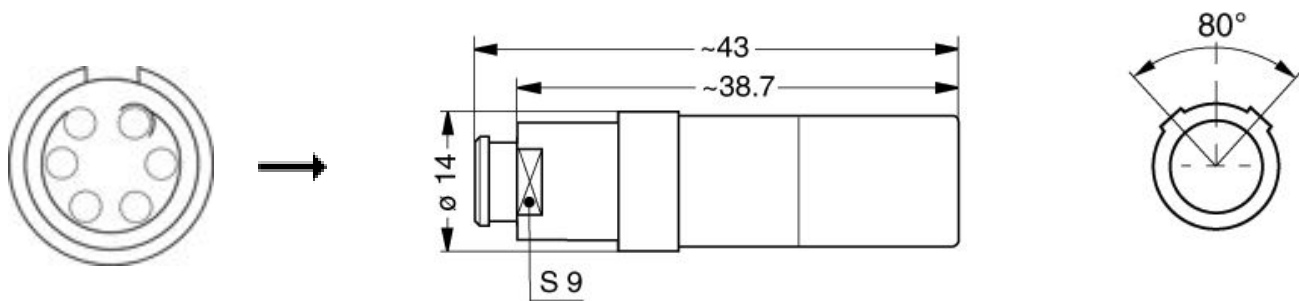

Dimensions







	A	L
mm.	14	43
in.	0,55	1,69

RECOMMENDED BY LEMO

Tools

LEMO products and services are provided "as is". LEMO makes no warranties or representations with regard to LEMO product & services or use of them, express, implied or statutory, including for accuracy, completeness, or security. The user is fully responsible for his products and applications using LEMO components.

Cables

CMN.06.T28.042QBCE	TPR (medical)		
CMN.06.T28.044PGZE		Grey	
CMN.06.T28.044PNZE			
106240	PTFE	White	
160140	PVC	Grey	
160260	PVC	Black	
60260	PTFE	White	
6280	PVC	Black	

LEMO products and services are provided "as is". LEMO makes no warranties or representations with regard to LEMO product & services or use of them, express, implied or statutory, including for accuracy, completeness, or security. The user is fully responsible for his products and applications using LEMO components.

Mouser Electronics

Authorized Distributor

Click to View Pricing, Inventory, Delivery & Lifecycle Information:

[LEMO:](#)

[PRC.M0.6GL.LC52GZ](#)