

## SUMMARY

### # Wires

Low voltage 2



Image is for illustrative purpose only

Series	1B
Termination type	Female solder
IP rating	50
AWG wire size	28.00 - 20.00
Cable Ø	4.30 - 5.20 mm
Status	active
Matching parts	<a href="#">FGG.1B.302.CLAD52</a>

### Download

[Request a quote](#)

[Eplan](#)

[Catalog](#)

## TECHNICAL DETAILS

### Mechanics

Shell Style/Model	PF*: Fixed receptacle, with two nuts, cable collet (back panel mounting)
Keying	1 key (alpha=0, plug: male contacts, receptacle: female contacts)
Housing Material	Brass (chrome plated [SAE AMS 2460]) shell and collet nut, nickel plated [SAE AMS QQ N 290] brass latch sleeve and mid pieces
Weight	18.33 g

### Performance

Configuration	1B.302 : 2 Low Voltage
Insulator	L: PEEK (UL 94 / V-0/1.5)
Rated Current	15 Amps

### Specifications

Contact Type:	Solder
Contact Dia.:	1.3 mm (0.051in)
Bucket Dia.:	1 mm (0.039in)
Max. Solid Conductor:	0.5 mm <sup>2</sup> (AWG 20)
Max. Stranded Conductor:	0.5 mm <sup>2</sup> (AWG 20)
R (max):	3.6 mOhm
Vtest (contact-shell):	1350 V (AC), 1910 V (DC)
Vtest (contact-contact):	1500 V (AC), 2120 V (DC)

LEMO products and services are provided "as is". LEMO makes no warranties or representations with regard to LEMO product & services or use of them, express, implied or statutory, including for accuracy, completeness, or security. The user is fully responsible for his products and applications using LEMO components.

## Others

Endurance (Shell): 5000  
 Temp (min / max): -55°C / +250°C  
 Humidity (max): <=95% [at 60 deg C / 140 F]  
 Vibration: 15 g [10 Hz - 2000 Hz]  
 Shock Resistance: 100 g [ 6 ms]  
 Climatical Category: 50/175/21  
 Shielding (min): 75 dB (10 MHz)  
 Shielding (min): 40 dB (1 GHz)  
 Salt Spray Corrosion: >1000 hr

## DRAWINGS

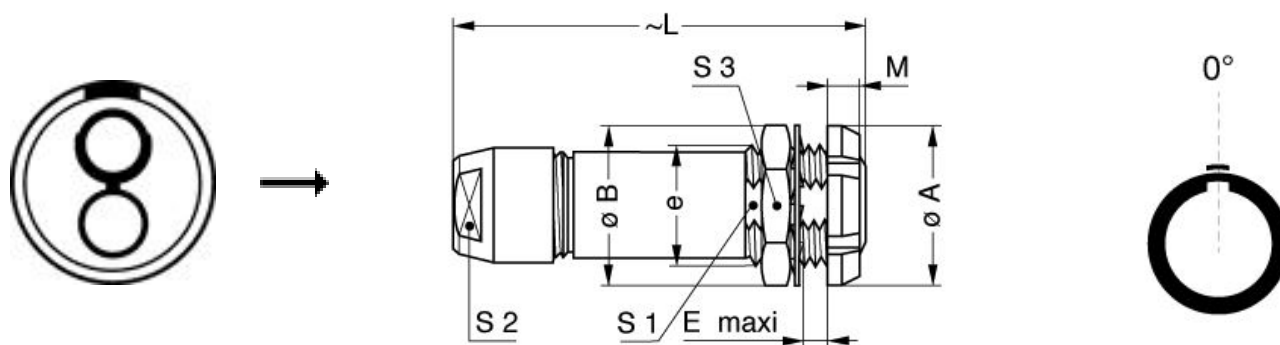

## Dimensions

	A	B	E	L	M	S1	S2	S3	e
mm.	16	16	5	40.5	3.5	10.5	9	14	M12x1.0
in.	0,63	0,63	0,20	1,59	0,14	0,41	0,35	0,55	







## RECOMMENDED BY LEMO

### Tools

Spanner wrench: [DCD.1B.015.PA090](#)

*LEMO products and services are provided "as is". LEMO makes no warranties or representations with regard to LEMO product & services or use of them, express, implied or statutory, including for accuracy, completeness, or security. The user is fully responsible for his products and applications using LEMO components.*

## Cables

CMN.02.T20.047PGZE		Grey	
CMN.02.T20.047PNZE			
CMN.02.T20.048QGZE	TPR (medical)	Grey	
120240	PVC	Black	
120250	PVC	Grey	
120501	PVC	Grey	
2221	PVC	Black	
4082	PVC	Grey	

LEMO products and services are provided "as is". LEMO makes no warranties or representations with regard to LEMO product & services or use of them, express, implied or statutory, including for accuracy, completeness, or security. The user is fully responsible for his products and applications using LEMO components.

# Mouser Electronics

Authorized Distributor

Click to View Pricing, Inventory, Delivery & Lifecycle Information:

[LEMO:](#)

[PFG.1B.302.CLLD52](#)