

SUMMARY

Wires

Low voltage 3

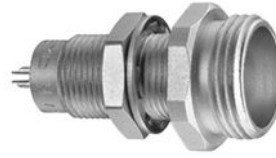

Image is for illustrative purpose only

Series 03
Termination type Female solder
IP rating 68
AWG wire size 34.00 - 28.00
Cable Ø 0.00 - 0.00 mm
Status active
Matching parts [FVG.03.303.CLAC27](#)

Download

[Request a quote](#)

[Catalog](#)

TECHNICAL DETAILS

Mechanics

Shell Style/Model HRG*: Fixed socket, key (G), hexagonal flange, nut fixing, no flats on fixing thread, watertight
Keying 1 key (alpha=0; Plug: male contacts; Receptacle: female contacts)
Housing Material Brass (chrome plated [SAE AMS 2460]) shell and collet nut, nickel plated [SAE AMS QQ N 290] brass latch sleeve and mid pieces
Variant PV : Watertight / Vacuum-tested
Weight 4.52 g

Performance

Configuration 03.303 : 3 Low Voltage
Insulator
Rated Current

Specifications

Contact Type: Solder
Contact Dia.: 0.5 mm (0.02in)
Bucket Dia.: 0.4 mm (0.016in)
Max. Solid Conductor: 0.09 mm² (AWG 28)
Max. Stranded Conductor: 0.05 mm² (AWG 30)

LEMO products and services are provided "as is". LEMO makes no warranties or representations with regard to LEMO product & services or use of them, express, implied or statutory, including for accuracy, completeness, or security. The user is fully responsible for his products and applications using LEMO components.

R (max): 8.7 mOhm

Others

Temp (min / max): -20°C / +100°C

Humidity (max): <=95% [at 60 deg C / 140 F]

Climatical Category: 20/200/21

Shielding (min): 100 dB (10 MHz)

Shielding (min): 80 dB (1 GHz)

R leak (He) (max): 0.0000001 mbar*l/s (if vacuum-tested)

Salt Spray Corrosion: >1000 hr

Pressure: 60 bars (120 bars with LEMO cable assembly)

DRAWINGS

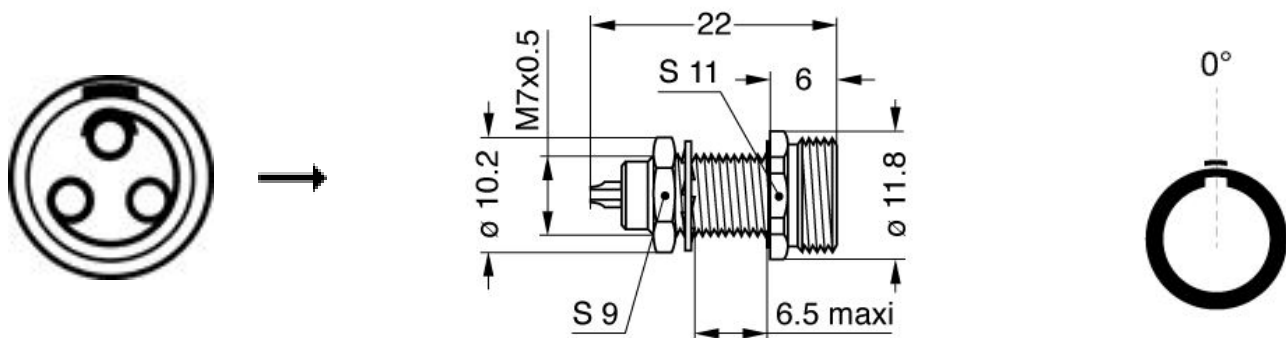

Dimensions







	A	B	E	L	M	S1	S2	e
mm.	11.8	10.2	6.5	22	6	11	9	M7x0.5
in.	0,46	0,40	0,26	0,87	0,24	0,43	0,35	

RECOMMENDED BY LEMO

Tools

LEMO products and services are provided "as is". LEMO makes no warranties or representations with regard to LEMO product & services or use of them, express, implied or statutory, including for accuracy, completeness, or security. The user is fully responsible for his products and applications using LEMO components.

Cables

CMN.03.T28.031PGCE	PVC	GREY	
CMN.03.T28.031PGZE		Grey	
CMN.03.T28.031PNCE	PVC	Black	
CMN.03.T28.031PNZE			
30110	PVC	Grey	
3041	PVC	Grey	
3050	PVC	Black	
3081	PVC	Black	
3280	PVC	Black	
60080	PVC	Grey	

LEMO products and services are provided "as is". LEMO makes no warranties or representations with regard to LEMO product & services or use of them, express, implied or statutory, including for accuracy, completeness, or security. The user is fully responsible for his products and applications using LEMO components.

Mouser Electronics

Authorized Distributor

Click to View Pricing, Inventory, Delivery & Lifecycle Information:

[LEMO:](#)

[HRG.03.303.CLLPV](#)