

SUMMARY



Image is for illustrative purpose only

Wires

Low voltage 2

Series	1E
Termination type	Female solder
IP rating	68
AWG wire size	28.00 - 20.00
Cable Ø	0.00 - 0.00 mm
Status	active
Matching parts	FFA.1E.302.CLAC40

Download

[Request a quote](#)

[Catalog](#)

TECHNICAL DETAILS

Mechanics

Shell Style/Model	HGP*: Fixed receptacle, nut fixing, watertight or vacuum-tight
Keying	Hermaphroditic keying (half moon insert) with female pin 1
Housing Material	Brass (chrome plated [SAE AMS 2460]) shell and collet nut, nickel plated [SAE AMS QQ N 290] brass latch sleeve and mid pieces
Variant	P : Watertight
Weight	21.60 g

Performance

Configuration	1E.302 : 2 Low Voltage
Insulator	L: PEEK (UL 94 / V-0/1.5)
Rated Current	15 Amps

Specifications

Contact Type:	Solder
Contact Dia.:	1.3 mm (0.051in)
Bucket Dia.:	1 mm (0.039in)
Max. Solid Conductor:	0.5 mm ² (AWG 20)
Max. Stranded Conductor:	0.5 mm ² (AWG 20)
R (max):	3.6 mOhm

LEMO products and services are provided "as is". LEMO makes no warranties or representations with regard to LEMO product & services or use of them, express, implied or statutory, including for accuracy, completeness, or security. The user is fully responsible for his products and applications using LEMO components.

Vtest: 1200 V (AC), 1700 V (DC)

Others

Endurance (Shell): 5000 mating cycles
Temp (min / max): -20°C / +100°C
Humidity (max): <=95% [at 60 deg C / 140 F]
Vibration: 15 g [10 Hz - 2000 Hz]
Shock Resistance: 100 g [6 ms]
Climatical Category: 20/80/21
Shielding (min): 95 dB (10 MHz)
Shielding (min): 80 dB (1 GHz)
Salt Spray Corrosion: >1000 hr
Pressure: 60 bars

DRAWINGS

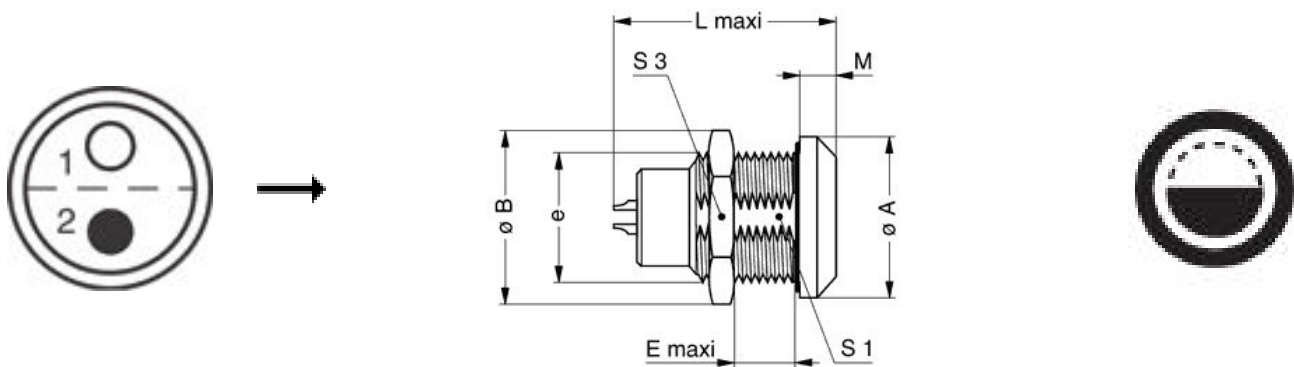

Dimensions

































	A	B	E	L	M	S1	S3	e
mm.	20	21.5	9	29.1	4.5	14.5	19	M16x1.0
in.	0,79	0,85	0,35	1,15	0,18	0,57	0,75	

RECOMMENDED BY LEMO

Tools

LEMO products and services are provided "as is". LEMO makes no warranties or representations with regard to LEMO product & services or use of them, express, implied or statutory, including for accuracy, completeness, or security. The user is fully responsible for his products and applications using LEMO components.

Cables

CMN.02.T20.047PGZE		Grey	
CMN.02.T20.047PNZE			
CMN.02.T20.048QGZE	TPR (medical)	Grey	
CMN.02.T28.030PGCE	PVC	GREY	
CMN.02.T28.030PGZE		Grey	
CMN.02.T28.030PNCE	PVC	Black	
CMN.02.T28.030PNZE			
102080	PVC	Grey	
120184	PVC	Black	
120240	PVC	Black	
120250	PVC	Grey	
120500	PVC	Grey	
120501	PVC	Grey	
120751	PVC	Grey	
20140	PVC	Grey	
20140	PVC	Grey	
20141	PVC	Grey	
20142	PVC	Red	
20143	PVC	Green	
20144	PVC	Black	
20145	PVC	Yellow	
20146	PVC	Black	
20240	PTFE	White	
20260	PVC	Black	
20264	PVC	Black	
20266	PVC	Violet	
2050	PVC	Black	
20550	PUR	Black	
20560	PUR	White	
2080	PVC	Grey	
220750	PVC	Grey	
2221	PVC	Black	
2260	PTFE	White	
2280	PVC	Black	

LEMO products and services are provided "as is". LEMO makes no warranties or representations with regard to LEMO product & services or use of them, express, implied or statutory, including for accuracy, completeness, or security. The user is fully responsible for his products and applications using LEMO components.

4082	PVC	Grey	
CMB.02.210.635	PUR	Black	

LEMO products and services are provided "as is". LEMO makes no warranties or representations with regard to LEMO product & services or use of them, express, implied or statutory, including for accuracy, completeness, or security. The user is fully responsible for his products and applications using LEMO components.

Mouser Electronics

Authorized Distributor

Click to View Pricing, Inventory, Delivery & Lifecycle Information:

[LEMO:](#)

[HGP.1E.302.CLLP](#)