

SUMMARY

Wires

Coax 1

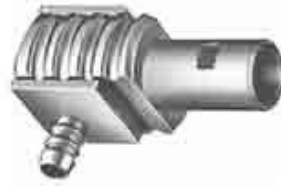

Image is for illustrative purpose only

Series 00
Termination type Male solder
IP rating 50
AWG wire size 0.00 - 0.00
Cable Ø 0.00 - 3.30 mm
Status active
Matching parts [ERA.00.250.NTL](#)

Download

[Request a quote](#)

[Catalog](#)

TECHNICAL DETAILS

Mechanics

Shell Style/Model FLV*: Elbow plug cable crimping with improved screen efficiency
Keying Circular, male
Housing Material Brass (nickel plated [SAE AMS QQ N 290]) shell, collet nut, latch sleeve and mid pieces
Weight 4.30 g

Performance

Configuration 00.250 : 1 Coax (50 Ohm)
Insulator T: PTFE
Rated Current 4 Amps

Specifications

Contact Type: Coaxial 50 Ohm (Solder)
Contact Dia.: 0.7 mm (0.028in)
Bucket Dia.: 0.6 mm (0.024in)
Test voltage: 2.1 kV (rms)
R (max): 6.1 mOhm
Vtest: 2100 V (AC), 3000 V (DC)
□
Impedance: 50 Ohm
VSWR: 1.09 + 0.11 * f /GHz

LEMO products and services are provided "as is". LEMO makes no warranties or representations with regard to LEMO product & services or use of them, express, implied or statutory, including for accuracy, completeness, or security. The user is fully responsible for his products and applications using LEMO components.

Others

Endurance (Shell): 5000 mating cycles

F ret (min): 100 N

Salt Spray Corrosion: >144 hr

DRAWINGS

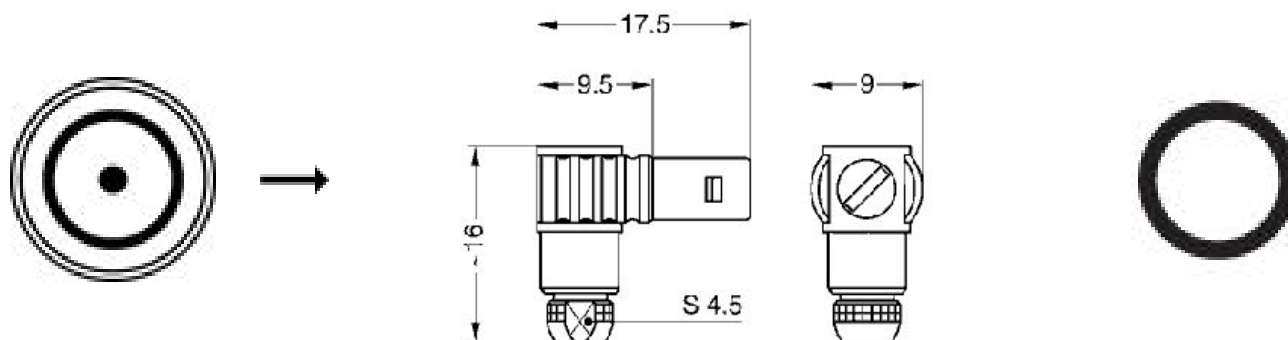

Dimensions

	A	H	L
mm.	9	15	17.5
in.	0,35	0,59	0,69

RECOMMENDED BY LEMO





Tools

Crimp Tool: [DPE.99.124.3K](#)

Die Tool: [DPN.99.124.3K](#)

Cables

LEMO products and services are provided "as is". LEMO makes no warranties or representations with regard to LEMO product & services or use of them, express, implied or statutory, including for accuracy, completeness, or security. The user is fully responsible for his products and applications using LEMO components.

17420	PVC	Black	
17450	COPOLYMER	Black	
178190	PTFE	Brown	
18700	PTFE	White	
18800	PTFE	White	
196270	PTFE	White	
31600	PTFE	Brown	
CCX.50.030.083.180B		White	
CCX.50.RG0.58AU14B	FEP	White	
CCX.50.RG1.74-U25N	PVC	Black	
CCX.50.RG1.74AU28N	PVC	Black	
CCX.50.RG1.74AU28N	PVC	Black	
CCX.50.RG1.74U25N	PVC	Black	
CCX.50.RG1.78BU18M	FEP	Brown	
CCX.50.RG1.78BU18M	PTFE	Brown	
CCX.50.RG1.88AU24B	TFE	White	
CCX.50.RG1.88AU26B	PFA	White	
CCX.50.RG1.88AU26B	PTFE	White	
CCX.50.RG1.96AU19B	PTFE	White	
CCX.50.RG1.96AU20B	PFA	White	
CCX.50.RG3.16BU26M	FEP	Brown	
CCX.50.RG3.16U28M	PTFE	Brown	
CCX.75.040.195327G	PVC	Grey	
CCX.75.RG1.79BU26M	FEP	Brown	
CCX.75.RG1.87AU26B	PFA	White	
CCX.75.RG1.87AU27B	PTFE	White	

LEMO products and services are provided "as is". LEMO makes no warranties or representations with regard to LEMO product & services or use of them, express, implied or statutory, including for accuracy, completeness, or security. The user is fully responsible for his products and applications using LEMO components.

Mouser Electronics

Authorized Distributor

Click to View Pricing, Inventory, Delivery & Lifecycle Information:

[LEMO:](#)

[FLV.00.250.NTAE35](#)