

## SUMMARY

### # Wires

Low voltage 4



Image is for illustrative purpose only

Series	1B
Termination type	Female solder
IP rating	50
AWG wire size	30.00 - 22.00
Cable Ø	4.30 - 5.20 mm
Status	obsolete
Alternative part	<a href="#">FPJ.1B.304.CLLD52Z</a>
Matching parts	<a href="#">EGJ.1B.304.CLA</a>

### Download

[Request a quote](#)

[Catalog](#)

## TECHNICAL DETAILS

### Mechanics

Shell Style/Model	FH*: Elbow plug, cable collet and nut for fitting a bend relief
Keying	2 keys (gamma=45, plug: female contacts, receptacle: male contacts)
Housing Material	Brass (chrome plated [SAE AMS 2460]) shell and collet nut, nickel plated [SAE AMS QQ N 290] brass latch sleeve and mid pieces
Variant	Z : Nut for fitting a bend relief
Weight	23.95 g

### Performance

Configuration	1B.304 : 4 Low Voltage
Insulator	L: PEEK (UL 94 / V-0/1.5)
Rated Current	10 Amps

### Specifications

Contact Type:	Solder
Contact Dia.:	0.9 mm (0.035in)
Bucket Dia.:	0.8 mm (0.031in)
Max. Solid Conductor:	0.34 mm <sup>2</sup> (AWG 22)
Max. Stranded Conductor:	0.34 mm <sup>2</sup> (AWG 22)
R (max):	4.8 mOhm

LEMO products and services are provided "as is". LEMO makes no warranties or representations with regard to LEMO product & services or use of them, express, implied or statutory, including for accuracy, completeness, or security. The user is fully responsible for his products and applications using LEMO components.

Vtest (contact-shell): 1450 V (AC), 2050 V (DC)  
 Vtest (contact-contact): 1350 V (AC), 1910 V (DC)

## Others

Endurance (Shell): 5000  
 Temp (min / max): -55°C / +250°C  
 Humidity (max): <=95% [at 60 deg C /140 F]  
 Vibration: 15 g [10 Hz - 2000 Hz]  
 Shock Resistance: 100 g [ 6 ms]  
 Climatical Category: 50/175/21  
 Shielding (min): 75 dB (10 MHz)  
 Shielding (min): 40 dB (1 GHz)  
 Salt Spray Corrosion: >1000 hr

## DRAWINGS

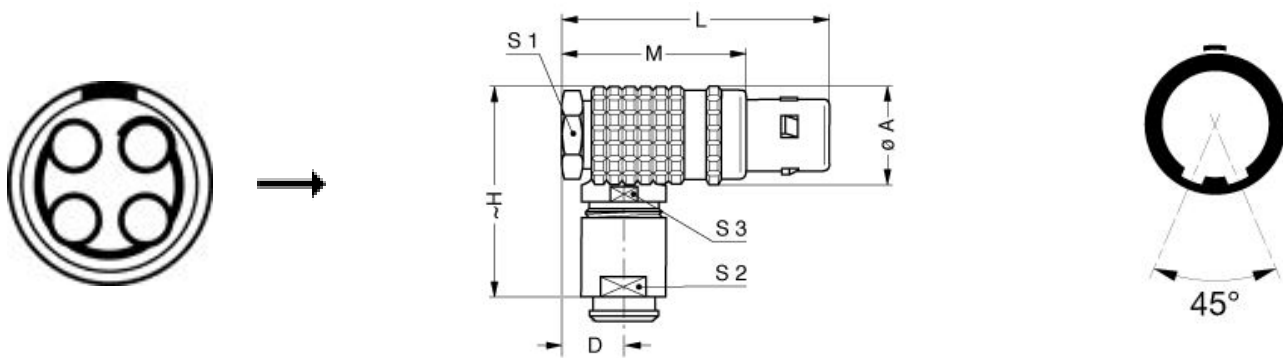

## Dimensions

	A	D	H	L	M	S1	S2	S3
mm.	13.5	8	28.1	36	25	11	9	10
in.	0,53	0,31	1,11	1,42	0,98	0,43	0,35	0,39







## RECOMMENDED BY LEMO

### Tools

LEMO products and services are provided "as is". LEMO makes no warranties or representations with regard to LEMO product & services or use of them, express, implied or statutory, including for accuracy, completeness, or security. The user is fully responsible for his products and applications using LEMO components.

Spanner wrench: [DCD.1B.015.PA090](#)

## Cables

CMN.04.T22.047QGC	TPR	Grey	
CMN.04.T22.048QGZE	TPR (medical)	Grey	
140240	PVC	Black	
140250	PVC	Grey	
40260	PVC	Black	
4080	PVC	Grey	
4221	PVC	Black	
4280	PVC	Black	
80080	PVC	Grey	
80082	PVC	Red	
80084	PVC	Black	

LEMO products and services are provided "as is". LEMO makes no warranties or representations with regard to LEMO product & services or use of them, express, implied or statutory, including for accuracy, completeness, or security. The user is fully responsible for his products and applications using LEMO components.

# Mouser Electronics

Authorized Distributor

Click to View Pricing, Inventory, Delivery & Lifecycle Information:

[LEMO:](#)

[FHJ.1B.304.CLLD52Z](#)