

## SUMMARY



Image is for illustrative purpose only

### # Wires

Low voltage 2

Series	0B
Termination type	Male crimp
IP rating	50
AWG wire size	24.00 - 20.00
Cable Ø	4.30 - 5.20 mm
Status	active
Matching parts	<a href="#">EGG.0B.302.CYM</a>

### Download

[Request a quote](#)

[Eplan](#)

[Catalog](#)

## TECHNICAL DETAILS

### Mechanics

Shell Style/Model	FF*: Straight plug, non-latching, cable collet
Keying	1 key (alpha=0, plug: male contacts, receptacle: female contacts)
Housing Material	Brass (chrome plated [SAE AMS 2460]) shell and collet nut, nickel plated [SAE AMS QQ N 290] brass latch sleeve and mid pieces
Weight	10.46 g

### Performance

Configuration	0B.302 : 2 Low Voltage
Insulator	Y: PEEK for crimp contacts
Rated Current	10 Amps

### Specifications

Contact Type: Crimp  
Contact Retention: 30 N  
Contact Dia.: 0.9 mm (0.035in)  
Bucket Dia.: 1.1 mm (0.043in)  
Min. Conductor: 0.25 mm<sup>2</sup> (AWG 24)  
Max. Conductor: 0.5 mm<sup>2</sup> (AWG 20)  
R (max): 4.8 mOhm  
Vtest (contact-shell): 1200 V (AC), 1700 V (DC)

LEMO products and services are provided "as is". LEMO makes no warranties or representations with regard to LEMO product & services or use of them, express, implied or statutory, including for accuracy, completeness, or security. The user is fully responsible for his products and applications using LEMO components.

Vtest(contact-contact): 1450 V (AC), 2100 V (DC)

## Others

Endurance (Shell): 5000  
Temp (min / max): -55°C / +250°C  
Humidity (max): ≤95% [at 60 deg C / 140 F]  
Vibration: 15 g [10 Hz - 2000 Hz]  
Shock Resistance: 100 g [ 6 ms]  
Climatical Category: 50/175/21  
Shielding (min): 75 dB (10 MHz)  
Shielding (min): 40 dB (1 GHz)  
Salt Spray Corrosion: >1000 hr

## DRAWINGS

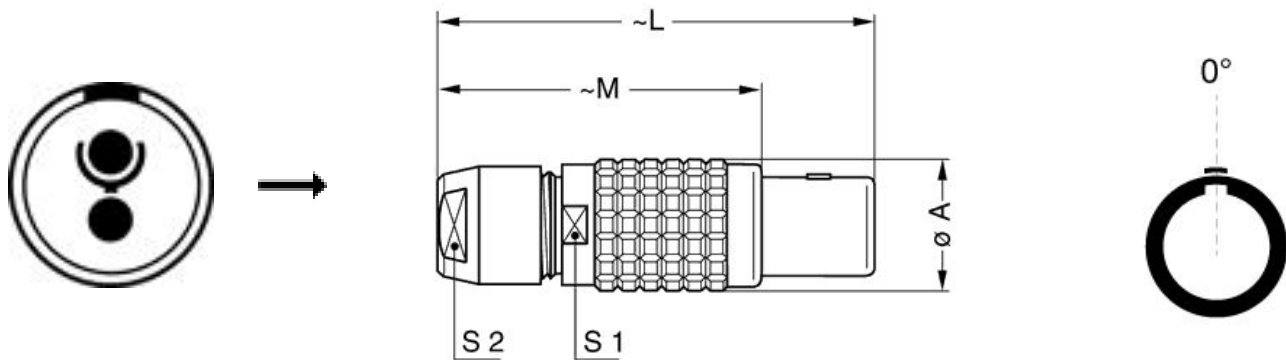

## Dimensions

	A	L	M	S1	S2
mm.	9.5	36	26	8	7
in.	0,37	1,42	1,02	0,31	0,28







## RECOMMENDED BY LEMO

### Tools

LEMO products and services are provided "as is". LEMO makes no warranties or representations with regard to LEMO product & services or use of them, express, implied or statutory, including for accuracy, completeness, or security. The user is fully responsible for his products and applications using LEMO components.

Crimp Tool: [DPC.91.701.V](#)  
 Crimp settings: AWG/Selector = 20-22-24/6-5-5  
 Positionner: [DCE.91.090.BVC](#)  
 Extractor: [DCF.91.090.2LT](#)  
 Replacement contact: FGG.0B.560.ZZC  
 Spanner wrench: [DCD.0B.005.PA070](#)

## Cables

CMN.02.T20.047PGZE		Grey	
CMN.02.T20.047PNZE			
CMN.02.T20.048QGZE	TPR (medical)	Grey	
120240	PVC	Black	
120250	PVC	Grey	
120501	PVC	Grey	
2221	PVC	Black	
4082	PVC	Grey	

*LEMO products and services are provided "as is". LEMO makes no warranties or representations with regard to LEMO product & services or use of them, express, implied or statutory, including for accuracy, completeness, or security. The user is fully responsible for his products and applications using LEMO components.*

# Mouser Electronics

Authorized Distributor

Click to View Pricing, Inventory, Delivery & Lifecycle Information:

[LEMO:](#)

[FFG.0B.302.CYCD52](#)