

SUMMARY

Wires

High voltage 1



Image is for illustrative purpose only

Series 3S
Termination type Male solder High-Voltage
IP rating 50
AWG wire size 0.00 - 0.00
Cable Ø 0.00 - 0.00 mm
Status active
Alternative part [FFB.3S.410.CTAC11](#)
Matching parts [ERA.3S.410.CTL](#)

Download

[Request a quote](#)
[Catalog](#)

TECHNICAL DETAILS

Mechanics

Shell Style/Model FFB*: Straight plug, cable collet and safety locking ring
Keying Circular, male
Housing Material Brass (chrome plated [SAE AMS 2460]) shell and collet nut, nickel plated [SAE AMS QQ N 290] brass latch sleeve and mid pieces
Weight 63.73 g

Performance

Configuration 3S.410 : 1 High Voltage
Insulator T: PTFE
Rated Current 10 Amps

Specifications

Contact Type: Solder
Test voltage (kV DC) 15
Test voltage (kV AC) 10.5
Creepage distance min.: 16.5 mm

Others

Endurance (Shell): 5000 mating cycles

LEMO products and services are provided "as is". LEMO makes no warranties or representations with regard to LEMO product & services or use of them, express, implied or statutory, including for accuracy, completeness, or security. The user is fully responsible for his products and applications using LEMO components.

Temp (min / max): -55 °C / +250 °C
 Humidity (max): <=95% [at 60 deg C / 140 F]
 Vibration: 15 g [10 Hz - 2000 Hz]
 Shock Resistance: 100 g [6 ms]
 Climatical Category: 50/175/21
 Shielding (min): 75 dB (10 MHz)
 Shielding (min): 40 dB (1 GHz)
 Salt Spray Corrosion: >144 hr

DRAWINGS

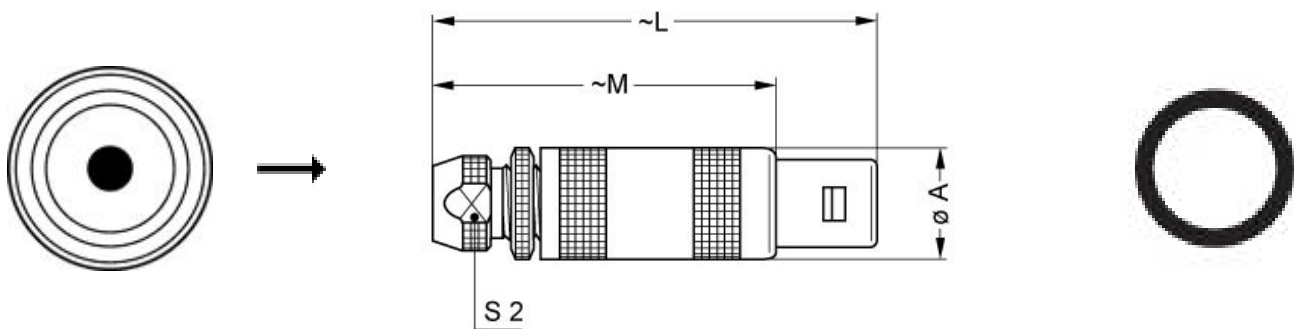

Dimensions

	A	L	M	S2
mm.	17.8	75	60	14
in.	0,70	2,95	2,36	0,55

RECOMMENDED BY LEMO

Tools

Spanner wrench: [DCP.91.023.TN](#)

LEMO products and services are provided "as is". LEMO makes no warranties or representations with regard to LEMO product & services or use of them, express, implied or statutory, including for accuracy, completeness, or security. The user is fully responsible for his products and applications using LEMO components.

LEMO products and services are provided "as is". LEMO makes no warranties or representations with regard to LEMO product & services or use of them, express, implied or statutory, including for accuracy, completeness, or security. The user is fully responsible for his products and applications using LEMO components.

Mouser Electronics

Authorized Distributor

Click to View Pricing, Inventory, Delivery & Lifecycle Information:

[LEMO:](#)

[FFB.3S.410.CTAC10](#)