

## SUMMARY



Image is for illustrative purpose only

### # Wires

Low voltage 3

Series 3S  
Termination type Male solder  
IP rating 50  
AWG wire size 22.00 - 14.00  
Cable Ø 4.30 - 5.70 mm  
Status active  
Matching parts [ERA.3S.303.CLL](#)

### Download

[Request a quote](#)  
[Catalog](#)

## TECHNICAL DETAILS

### Mechanics

Shell Style/Model FFA\*: Straight plug, cable collet  
Keying Hermaphroditic keying (half moon insert) with male pin 1  
Housing Material Brass (chrome plated [SAE AMS 2460]) shell and collet nut, nickel plated [SAE AMS QQ N 290] brass latch sleeve and mid pieces  
Weight 54.75 g

### Performance

Configuration 3S.303 : 3 Low Voltage  
Insulator L: PEEK (UL 94 / V-0/1.5)  
Rated Current 20 Amps

### Specifications

Contact Type: Solder  
Vtest: 1500 V (AC), 2100 V (DC)

### Others

Endurance (Shell): 5000 mating cycles  
Temp (min / max): -55° C / +250° C  
Humidity (max): <=95% [at 60 deg C / 140 F]

LEMO products and services are provided "as is". LEMO makes no warranties or representations with regard to LEMO product & services or use of them, express, implied or statutory, including for accuracy, completeness, or security. The user is fully responsible for his products and applications using LEMO components.

Vibration: 15 g [10 Hz - 2000 Hz]  
 Shock Resistance: 100 g [ 6 ms]  
 Climatical Category: 50/175/21  
 Shielding (min): 75 dB (10 MHz)  
 Shielding (min): 40 dB (1 GHz)  
 Salt Spray Corrosion: >144 hr

## DRAWINGS

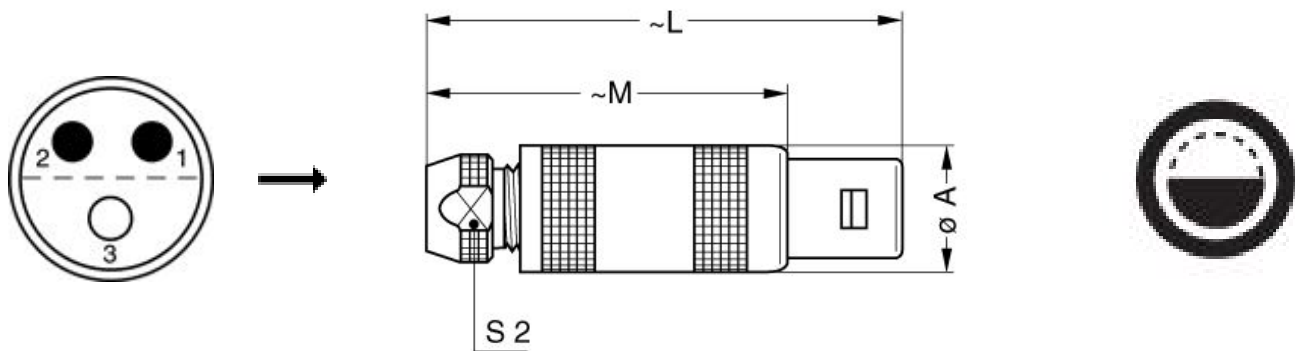

### Dimensions

	A	L	M	S2
mm.	17.8	61	46	14
in.	0,70	2,40	1,81	0,55

## RECOMMENDED BY LEMO









### Tools

Spanner wrench: [DCP.91.023.TN](#)

### Cables

CMN.03.T18.055PGZE		Grey	
CMN.03.T18.055PNZE			

*LEMO products and services are provided "as is". LEMO makes no warranties or representations with regard to LEMO product & services or use of them, express, implied or statutory, including for accuracy, completeness, or security. The user is fully responsible for his products and applications using LEMO components.*

CMN.03.T18.055QGZE	TPR (medical)	Grey	
CMN.03.T20.049PGZE		Grey	
CMN.03.T20.049PNZE			
130240	PVC	Black	
130250	PVC	Grey	
230500	PVC	Grey	
30260	PVC	Black	
3220	PVC	Black	
60080	PVC	Grey	

*LEMO products and services are provided "as is". LEMO makes no warranties or representations with regard to LEMO product & services or use of them, express, implied or statutory, including for accuracy, completeness, or security. The user is fully responsible for his products and applications using LEMO components.*

# Mouser Electronics

Authorized Distributor

Click to View Pricing, Inventory, Delivery & Lifecycle Information:

[LEMO:](#)

[FFA.3S.303.CLAC57](#)