

SUMMARY



Image is for illustrative purpose only

Wires

Low voltage 1

Series 2S
Termination type Male solder
IP rating 50
AWG wire size 0.00 - 10.00
Cable Ø 5.30 - 6.20 mm
Status active
Matching parts [ERA.2S.140.CTL](#)

Download

[Request a quote](#)
[Catalog](#)

TECHNICAL DETAILS

Mechanics

Shell Style/Model FFA*: Straight plug, cable collet
Keying Circular, male
Housing Material Brass (chrome plated [SAE AMS 2460]) shell and collet nut, nickel plated [SAE AMS QQ N 290] brass latch sleeve and mid pieces
Weight 33.11 g

Performance

Configuration 2S.140 : 1 Low Voltage
Insulator T: PTFE
Rated Current 40 Amps

Specifications

Contact Type: Solder
V_{test} (contact-shell): 1800 V (AC), 2550 V (DC)
V_{test} (contact-contact): 1800 V (AC), 2550 V (DC)

Others

Endurance (Shell): 5000 mating cycles
Temp (min / max): -55°C / +250°C

LEMO products and services are provided "as is". LEMO makes no warranties or representations with regard to LEMO product & services or use of them, express, implied or statutory, including for accuracy, completeness, or security. The user is fully responsible for his products and applications using LEMO components.

Humidity (max): <=95% [at 60 deg C /140 F]
 Vibration: 15 g [10 Hz - 2000 Hz]
 Shock Resistance: 100 g [6 ms]
 Climatical Category: 50/175/21
 Shielding (min): 75 dB (10 MHz)
 Shielding (min): 40 dB (1 GHz)
 Salt Spray Corrosion: >144 hr

DRAWINGS

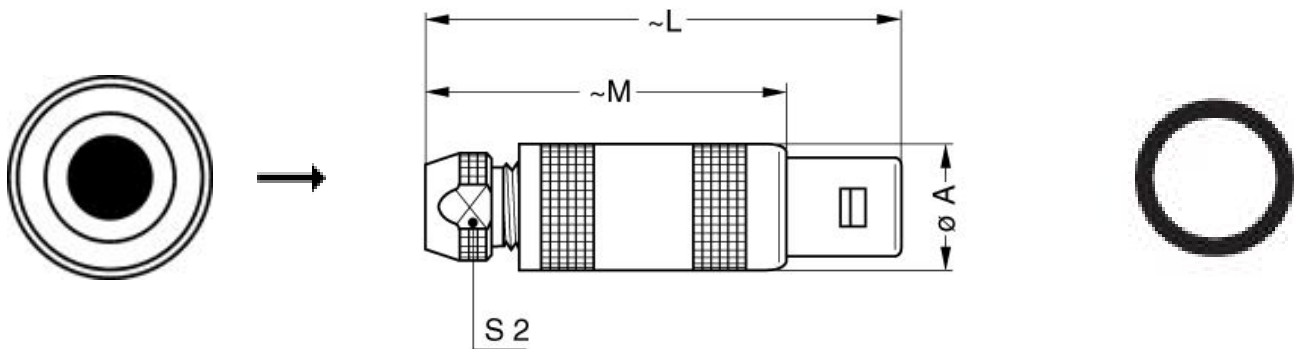

Dimensions

	A	L	M	S2
mm.	14.8	52	40	11
in.	0,58	2,05	1,57	0,43

RECOMMENDED BY LEMO

Tools

Spanner wrench: [DCD.2S.025.PA110](#)

LEMO products and services are provided "as is". LEMO makes no warranties or representations with regard to LEMO product & services or use of them, express, implied or statutory, including for accuracy, completeness, or security. The user is fully responsible for his products and applications using LEMO components.

Mouser Electronics

Authorized Distributor

Click to View Pricing, Inventory, Delivery & Lifecycle Information:

[LEMO:](#)

[FFA.2S.140.CTAC62](#)