

## SUMMARY

### # Wires

Low voltage 6



Image is for illustrative purpose only

Series	OB
Termination type	Male solder
IP rating	50
AWG wire size	34.00 - 28.00
Cable Ø	0.00 - 0.00 mm
Status	active
Matching parts	<a href="#">PHG.OB.306.CLLD32</a>

### Download

[Request a quote](#)

[Catalog](#)

## TECHNICAL DETAILS

### Mechanics

Shell Style/Model	FA*: Fixed plug, non-latching, nut fixing
Keying	1 key (alpha=0, plug: male contacts, receptacle: female contacts)
Housing Material	Brass (chrome plated [SAE AMS 2460]) shell and collet nut, nickel plated [SAE AMS QQ N 290] brass latch sleeve and mid pieces
Weight	5.07 g

### Performance

Configuration	OB.306 : 6 Low Voltage
Insulator	L: PEEK (UL 94 / V-0/1.5)
Rated Current	2.5 Amps

### Specifications

Contact Type: Solder  
Contact Dia.: 0.5 mm (0.02in)  
Bucket Dia.: 0.45 mm (0.018in)  
Max. Solid Conductor: 0.09 mm<sup>2</sup> (AWG 28)  
Max. Stranded Conductor: 0.09 mm<sup>2</sup> (AWG 28)  
R (max): 8.7 mOhm  
Vtest (contact-shell): 650 V (AC), 920 V (DC)  
Vtest (contact-contact): 850 V (AC), 1200 V (DC)

LEMO products and services are provided "as is". LEMO makes no warranties or representations with regard to LEMO product & services or use of them, express, implied or statutory, including for accuracy, completeness, or security. The user is fully responsible for his products and applications using LEMO components.

## Others

Endurance (Shell): 5000  
 Temp (min / max): -55°C / +250°C  
 Humidity (max): <=95% [at 60 deg C / 140 F]  
 Vibration: 15 g [10 Hz - 2000 Hz]  
 Shock Resistance: 100 g [ 6 ms]  
 Climatical Category: 50/175/21  
 Shielding (min): 75 dB (10 MHz)  
 Shielding (min): 40 dB (1 GHz)  
 Salt Spray Corrosion: >1000 hr

## DRAWINGS

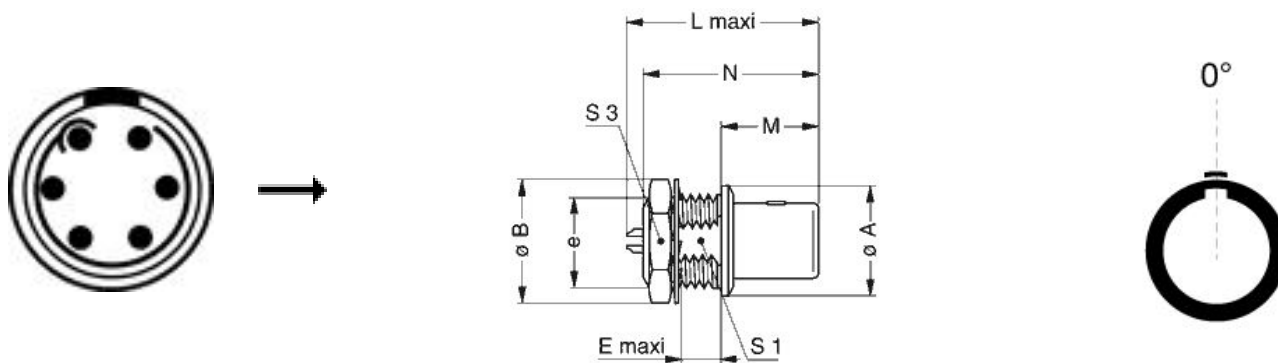

## Dimensions







	A	B	E	L	M	N	S1	S3	e
mm.	10	12.5	4.2	20.8	11.5	18.9	8.2	11	M9x0.6
in.	0,39	0,49	0,17	0,82	0,45	0,74	0,32	0,43	

## RECOMMENDED BY LEMO

### Tools

*LEMO products and services are provided "as is". LEMO makes no warranties or representations with regard to LEMO product & services or use of them, express, implied or statutory, including for accuracy, completeness, or security. The user is fully responsible for his products and applications using LEMO components.*

## Cables

CMN.06.T28.031PGCE	PVC	GREY	
CMN.06.T28.031PGZE		Grey	
CMN.06.T28.031PNCE	PVC	Black	
CMN.06.T28.031PNZE			
CMN.06.T28.042QBCE	TPR (medical)		
CMN.06.T28.044PGZE		Grey	
CMN.06.T28.044PNZE			
12080	PVC	Grey	
6280	PVC	Black	

LEMO products and services are provided "as is". LEMO makes no warranties or representations with regard to LEMO product & services or use of them, express, implied or statutory, including for accuracy, completeness, or security. The user is fully responsible for his products and applications using LEMO components.

# Mouser Electronics

Authorized Distributor

Click to View Pricing, Inventory, Delivery & Lifecycle Information:

[LEMO:](#)

[FAG.0B.306.CLA](#)