

SUMMARY



Image is for illustrative purpose only

Wires

Low voltage 8

Series	2C
Termination type	Male solder
IP rating	50
AWG wire size	32.00 - 24.00
Cable Ø	0.00 - 0.00 mm
Status	active
Matching parts	PCA.2C.308.CLLC62

Download

[Request a quote](#)

[Catalog](#)

TECHNICAL DETAILS

Mechanics

Shell Style/Model	FAA*: Fixed plug, non-latching, nut fixing
Keying	Hermaphroditic keying (half moon insert) with male pin 1
Housing Material	Brass (chrome plated [SAE AMS 2460]) shell and collet nut, nickel plated [SAE AMS QQ N 290] brass latch sleeve and mid pieces
Weight	9.98 g

Performance

Configuration	2C.308 : 8 Low Voltage
Insulator	L: PEEK (UL 94 / V-0/1.5)
Rated Current	7 Amps

Specifications

Contact Type:	Solder
Contact Dia.:	0.7 mm (0.028in)
Bucket Dia.:	0.6 mm (0.024in)
Max. Solid Conductor:	0.25 mm ² (AWG 24)
Max. Stranded Conductor:	0.14 mm ² (AWG 26)
R (max):	6.1 mOhm
Vtest:	950 V (AC), 1350 V (DC)

LEMO products and services are provided "as is". LEMO makes no warranties or representations with regard to LEMO product & services or use of them, express, implied or statutory, including for accuracy, completeness, or security. The user is fully responsible for his products and applications using LEMO components.

Others

Endurance (Shell): 500 mating cycles

Salt Spray Corrosion: >1000 hr

DRAWINGS

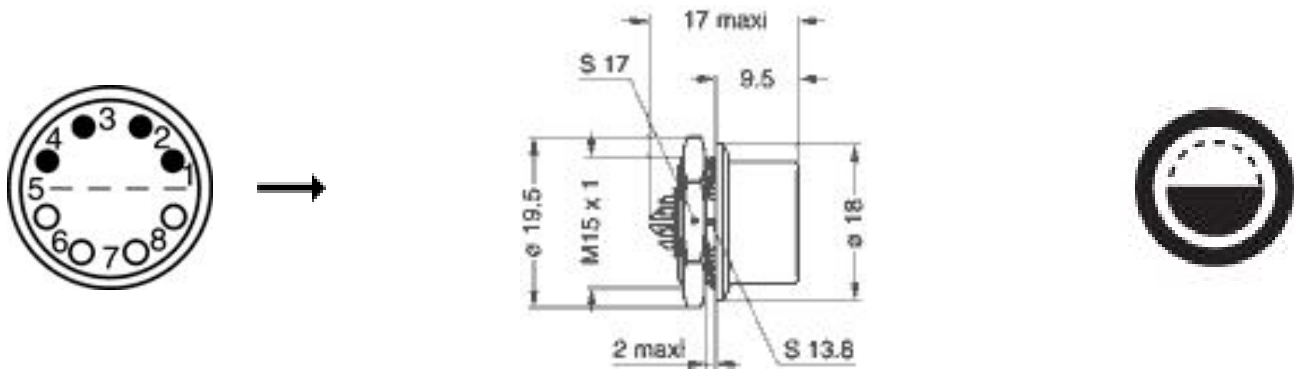

Dimensions

	A	L	e
mm.	18	17	M15x1.0
in.	0,71	0,67	







RECOMMENDED BY LEMO

Tools

Cables

CMN.08.T26.042QGZE	TPR (medical)	Grey	
108240	PTFE	White	
108260	PTFE	White	
16080	PVC	Grey	

LEMO products and services are provided "as is". LEMO makes no warranties or representations with regard to LEMO product & services or use of them, express, implied or statutory, including for accuracy, completeness, or security. The user is fully responsible for his products and applications using LEMO components.

180260	PVC	Black	
280250	PVC	Grey	
335990	PVC	Black	
335991	PVC	Black	
42265	PVC	Yellow	
80140	PVC	Grey	
8050	PVC	Black	
8280	PVC	Black	

LEMO products and services are provided "as is". LEMO makes no warranties or representations with regard to LEMO product & services or use of them, express, implied or statutory, including for accuracy, completeness, or security. The user is fully responsible for his products and applications using LEMO components.

Mouser Electronics

Authorized Distributor

Click to View Pricing, Inventory, Delivery & Lifecycle Information:

[LEMO:](#)

[FAA.2C.308.CLA](#)