

SUMMARY



Image is for illustrative purpose only

Wires

Low voltage 3

Series	0E
Termination type	Male solder
IP rating	68
AWG wire size	32.00 - 24.00
Cable Ø	0.00 - 0.00 mm
Status	active
Matching parts	PCA.0E.303.CLKC40

Download

[Request a quote](#)

[Catalog](#)

TECHNICAL DETAILS

Mechanics

Shell Style/Model	FAA*: Fixed plug, non-latching, nut fixing
Keying	Hermaphroditic keying (half moon insert) with male pin 1
Housing Material	Brass (chrome plated [SAE AMS 2460]) shell and collet nut, nickel plated [SAE AMS QQ N 290] brass latch sleeve and mid pieces
Weight	16.07 g

Performance

Configuration	0E.303 : 3 Low Voltage
Insulator	L: PEEK (UL 94 / V-0/1.5)
Rated Current	7 Amps

Specifications

Contact Type: Solder
Contact Dia.: 0.7 mm (0.028in)
Bucket Dia.: 0.6 mm (0.024in)
Max. Solid Conductor: 0.25 mm² (AWG 24)
Max. Stranded Conductor: 0.14 mm² (AWG 26)
R (max): 6.1 mOhm
Vtest: 1060 V (AC), 1500 V (DC)

LEMO products and services are provided "as is". LEMO makes no warranties or representations with regard to LEMO product & services or use of them, express, implied or statutory, including for accuracy, completeness, or security. The user is fully responsible for his products and applications using LEMO components.

Others

Endurance (Shell): 5000 mating cycles
Temp (min / max): -55°C / +200°C
Humidity (max): <=95% [at 60 deg C / 140 F]
Vibration: 15 g [10 Hz - 2000 Hz]
Shock Resistance: 100 g [6 ms]
Climatical Category: 50/175/21
Shielding (min): 95 dB (10 MHz)
Shielding (min): 80 dB (1 GHz)
Salt Spray Corrosion: >1000 hr

DRAWINGS

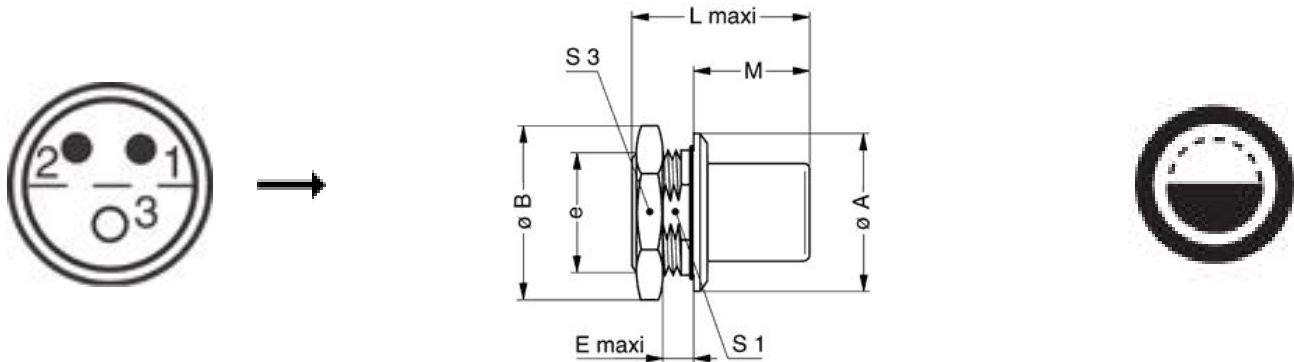

Dimensions

	A	B	E	L	M	S1	S3	e
mm.	18	19.5	3.5	19.5	13	12.5	17	M14x1.0
in.	0,71	0,77	0,14	0,77	0,51	0,49	0,67	











RECOMMENDED BY LEMO

Tools

Caps: [BFA.OE.100.NAS](#)

LEMO products and services are provided "as is". LEMO makes no warranties or representations with regard to LEMO product & services or use of them, express, implied or statutory, including for accuracy, completeness, or security. The user is fully responsible for his products and applications using LEMO components.

Cables

CMN.03.T28.031PGCE	PVC	GREY	
CMN.03.T28.031PGZE		Grey	
CMN.03.T28.031PNCE	PVC	Black	
CMN.03.T28.031PNZE			
130250	PVC	Grey	
30110	PVC	Grey	
30141	PVC	Grey	
30260	PVC	Black	
3041	PVC	Grey	
3050	PVC	Black	
3081	PVC	Black	
3280	PVC	Black	
60080	PVC	Grey	

LEMO products and services are provided "as is". LEMO makes no warranties or representations with regard to LEMO product & services or use of them, express, implied or statutory, including for accuracy, completeness, or security. The user is fully responsible for his products and applications using LEMO components.

Mouser Electronics

Authorized Distributor

Click to View Pricing, Inventory, Delivery & Lifecycle Information:

[LEMO:](#)

[FAA.0E.303.CLA](#)