

SUMMARY



Image is for illustrative purpose only

Wires

Low voltage 2

Series 0S
Termination type Female solder
IP rating 50
AWG wire size 30.00 - 22.00
Cable Ø 0.00 - 0.00 mm
Status active
Matching parts [FFA.0S.302.BLAC42](#)

Download

[Request a quote](#)
[Catalog](#)

TECHNICAL DETAILS

Mechanics

Shell Style/Model ERD*: Fixed receptacle with two nuts (back panel mounting)
Keying Hermaphroditic keying (half moon insert) with female pin 1
Housing Material POM (black Polyoxymethylene) shell and collet nut, nickel plated [SAE AMS QQ N 290] brass latch sleeve and mid pieces
Weight 2.32 g

Performance

Configuration 0S.302 : 2 Low Voltage
Insulator L: PEEK (UL 94 / V-0/1.5)
Rated Current 10 Amps

Specifications

Contact Type: Solder
Contact Dia.: 0.9 mm (0.0354in)
Bucket Dia.: 0.8 mm (0.031in)
Max. Solid Conductor: 0.34 mm² (AWG 22)
R (max): 4.8 mOhm
Vtest: 1500 V (AC), 2100 V (DC)

Others

LEMO products and services are provided "as is". LEMO makes no warranties or representations with regard to LEMO product & services or use of them, express, implied or statutory, including for accuracy, completeness, or security. The user is fully responsible for his products and applications using LEMO components.

Endurance (Shell): 5000 mating cycles
 Temp (min / max): -50°C / +115°C
 Humidity (max): <=95% [at 60 deg C / 140 F]
 Vibration: 15 g [10 Hz - 2000 Hz]
 Shock Resistance: 100 g [6 ms]
 Climatical Category: 50/175/21
 Shielding (min): 75 dB (10 MHz)
 Shielding (min): 40 dB (1 GHz)

DRAWINGS

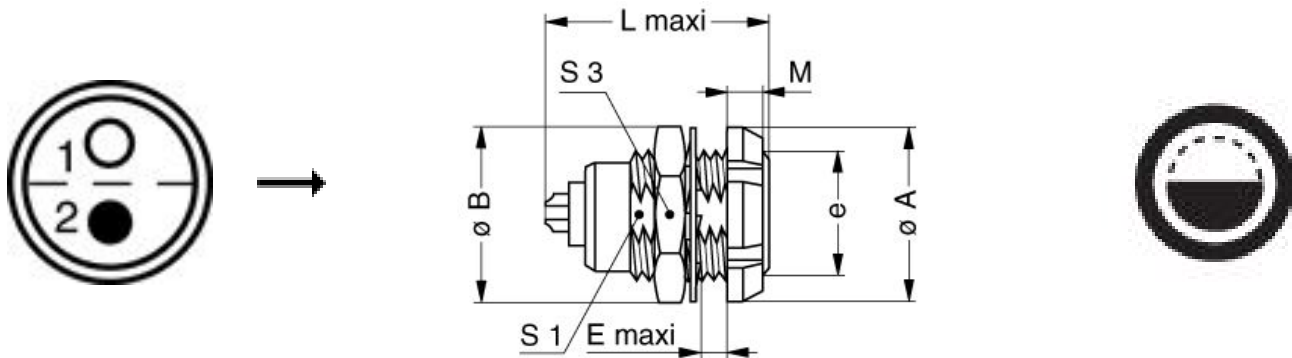

Dimensions

























	A	B	E	L	M	S1	S3	e
mm.	12	12.5	5.5	18.5	2.5	8.2	11	M9x0.6
in.	0,47	0,49	0,22	0,73	0,10	0,32	0,43	

RECOMMENDED BY LEMO

Tools

Cables

LEMO products and services are provided "as is". LEMO makes no warranties or representations with regard to LEMO product & services or use of them, express, implied or statutory, including for accuracy, completeness, or security. The user is fully responsible for his products and applications using LEMO components.

CMN.02.T28.030PGCE	PVC	GREY	
CMN.02.T28.030PGZE		Grey	
CMN.02.T28.030PNCE	PVC	Black	
CMN.02.T28.030PNZE			
102080	PVC	Grey	
120184	PVC	Black	
120240	PVC	Black	
120250	PVC	Grey	
20140	PVC	Grey	
20140	PVC	Grey	
20141	PVC	Grey	
20142	PVC	Red	
20143	PVC	Green	
20144	PVC	Black	
20145	PVC	Yellow	
20146	PVC	Black	
20240	PTFE	White	
20260	PVC	Black	
20264	PVC	Black	
20266	PVC	Violet	
2050	PVC	Black	
20550	PUR	Black	
20560	PUR	White	
2080	PVC	Grey	
2221	PVC	Black	
2260	PTFE	White	
2280	PVC	Black	
4082	PVC	Grey	
CMB.02.210.635	PUR	Black	

LEMO products and services are provided "as is". LEMO makes no warranties or representations with regard to LEMO product & services or use of them, express, implied or statutory, including for accuracy, completeness, or security. The user is fully responsible for his products and applications using LEMO components.

Mouser Electronics

Authorized Distributor

Click to View Pricing, Inventory, Delivery & Lifecycle Information:

[LEMO:](#)

[ERD.0S.302.BLLN](#)