

## SUMMARY



Image is for illustrative purpose only

### # Wires

Low voltage 4

Series	2B
Termination type	Female crimp
IP rating	50
AWG wire size	20.00 - 18.00
Cable Ø	0.00 - 0.00 mm
Status	active
Matching parts	<a href="#">FGG.2B.304.CYCD82Z</a>

### Download

[Request a quote](#)

[Eplan](#)

[Catalog](#)

## TECHNICAL DETAILS

### Mechanics

Shell Style/Model	EE*: Fixed receptacle, nut fixing (back panel mounting)
Keying	1 key (alpha=0, plug: male contacts, receptacle: female contacts)
Housing Material	Brass (chrome plated [SAE AMS 2460]) shell and collet nut, nickel plated [SAE AMS QQ N 290] brass latch sleeve and mid pieces
Weight	15.91 g

### Performance

Configuration	2B.304 : 4 Low Voltage
Insulator	Y: PEEK for crimp contacts
Rated Current	15 Amps

### Specifications

Contact Type: Crimp  
Contact Retention: 40 N  
Contact Dia.: 1.3 mm (0.051in)  
Bucket Dia.: 1.4 mm (0.055in)  
Min. Conductor: 0.5 mm<sup>2</sup> (AWG 20)  
Max. Conductor: 1 mm<sup>2</sup> (AWG 18)  
R (max): 3.6 mOhm  
Vtest (contact-shell): 2200 V (AC), 3110 V (DC)

LEMO products and services are provided "as is". LEMO makes no warranties or representations with regard to LEMO product & services or use of them, express, implied or statutory, including for accuracy, completeness, or security. The user is fully responsible for his products and applications using LEMO components.

Vtest (contact-contact): 2200 V (AC), 3110 V (DC)

## Others

Endurance (Shell): 5000  
Temp (min / max): -55°C / +250°C  
Humidity (max): ≤95% [at 60 deg C / 140 F]  
Vibration: 15 g [10 Hz - 2000 Hz]  
Shock Resistance: 100 g [ 6 ms]  
Climatical Category: 50/175/21  
Shielding (min): 75 dB (10 MHz)  
Shielding (min): 40 dB (1 GHz)  
Salt Spray Corrosion: >1000 hr

## DRAWINGS

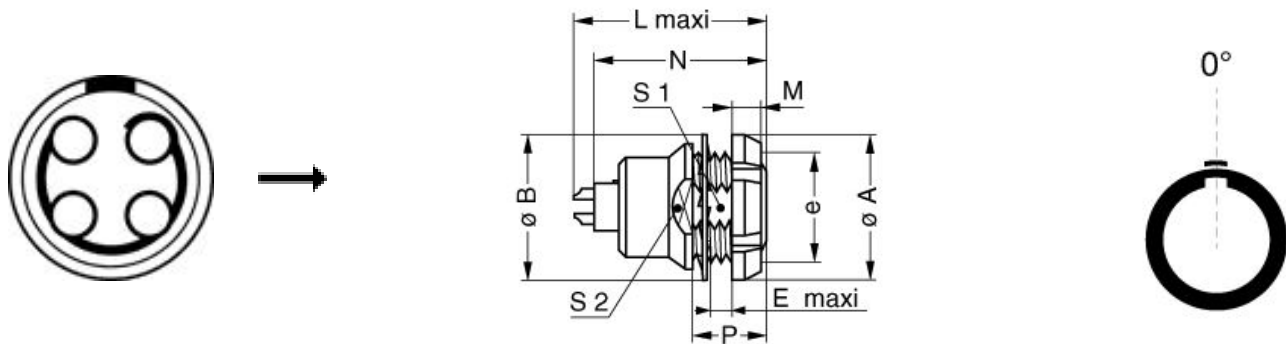

## Dimensions

	A	B	E	L	M	N	P	S1	S2	e
mm.	20	20	4.3	26.7	3.5	24.6	9	13.5	15	M15x1.0
in.	0,79	0,79	0,17	1,05	0,14	0,97	0,35	0,53	0,59	























## RECOMMENDED BY LEMO

### Tools

LEMO products and services are provided "as is". LEMO makes no warranties or representations with regard to LEMO product & services or use of them, express, implied or statutory, including for accuracy, completeness, or security. The user is fully responsible for his products and applications using LEMO components.

Crimp Tool: [DPC.91.701.V](#)  
 Crimp settings: AWG/Selector = 18-20/8-7  
 Positionner: [DCE.91.132.BVM](#)  
 Extractor: [DCF.91.131.2LT](#)  
 Replacement contact: EGG.2B.665.ZZM

## Cables

CMN.04.T20.053PGZE		Grey	
CMN.04.T20.053PNZE			
CMN.04.T20.053QGZE	TPR (medical)	Grey	
CMN.04.T22.047QGC	TPR	Grey	
CMN.04.T22.048QGZE	TPR (medical)	Grey	
CMN.04.T28.031PGCE	PVC	GREY	
CMN.04.T28.031PGZE		Grey	
CMN.04.T28.031PNCE	PVC	Black	
CMN.04.T28.031PNZE			
CMN.04.T28.031QGC	TPR	Grey	
140240	PVC	Black	
140250	PVC	Grey	
240500	PVC	Grey	
240750	PVC	Grey	
40080	PVC	Black	
40086	PVC	Blue	
40140	PVC	Black	
40240	PTFE	White	
40260	PVC	Black	
4041	PVC	Grey	
4050	PVC	Black	
4080	PVC	Grey	
417920	PVC	Grey	
4220	PVC	Black	
4221	PVC	Black	
4260	PTFE	White	
4280	PVC	Black	
80080	PVC	Grey	
80082	PVC	Red	
80084	PVC	Black	
CTR.75.030.121870G	PVC	Grey	

LEMO products and services are provided "as is". LEMO makes no warranties or representations with regard to LEMO product & services or use of them, express, implied or statutory, including for accuracy, completeness, or security. The user is fully responsible for his products and applications using LEMO components.

---

*LEMO products and services are provided "as is". LEMO makes no warranties or representations with regard to LEMO product & services or use of them, express, implied or statutory, including for accuracy, completeness, or security. The user is fully responsible for his products and applications using LEMO components.*

# Mouser Electronics

Authorized Distributor

Click to View Pricing, Inventory, Delivery & Lifecycle Information:

[LEMO:](#)

[EEG.2B.304.CYM](#)