

SUMMARY



Image is for illustrative purpose only

Wires

Low voltage 4

Series 0K
Termination type Female print PCB
IP rating 68
AWG wire size 30.00 - 22.00
Cable Ø 0.00 - 0.00 mm
Status active
Matching parts [FGG.0K.304.CLAC40](#)

Download

[Request a quote](#)
[PCB Eagle Pattern](#)
[PCB Altium Pattern](#)
[PCB KiCad Pattern](#)
[Catalog](#)

TECHNICAL DETAILS

Mechanics

Shell Style/Model EE*: Fixed receptacle, nut fixing, with straight contacts for printed circuit (back panel mounting)
Keying 1 key (alpha=0, plug: male contacts, receptacle: female contacts)
Housing Material Brass (chrome plated [SAE AMS 2460]) shell and collet nut, nickel plated [SAE AMS QQ N 290] brass latch sleeve and mid pieces
Weight 11.93 g

Performance

Configuration 0K.304 : 4 Low Voltage
Insulator L: PEEK (UL 94 / V-0/1.5)
Rated Current 7 Amps

Specifications

Contact Type: Print (straight)
Contact Dia.: 0.7 mm (0.028in)
R (max): 6.1 mOhm
Vtest (contact-shell): 700 V (AC), 990 V (DC)
Vtest (contact-contact): 850 V (AC), 1200 V (DC)

Others

LEMO products and services are provided "as is". LEMO makes no warranties or representations with regard to LEMO product & services or use of them, express, implied or statutory, including for accuracy, completeness, or security. The user is fully responsible for his products and applications using LEMO components.

Endurance (Shell): 5000 mating cycles
 Temp (min / max): -55°C / +200°C
 Humidity (max): <=95% [at 60 deg C / 140 F]
 Vibration: 15 g [10 Hz - 2000 Hz]
 Shock Resistance: 100 g [6 ms]
 Climatical Category: 50/175/21
 Shielding (min): 95 dB (10 MHz)
 Shielding (min): 80 dB (1 GHz)
 Salt Spray Corrosion: >1000 hr

DRAWINGS

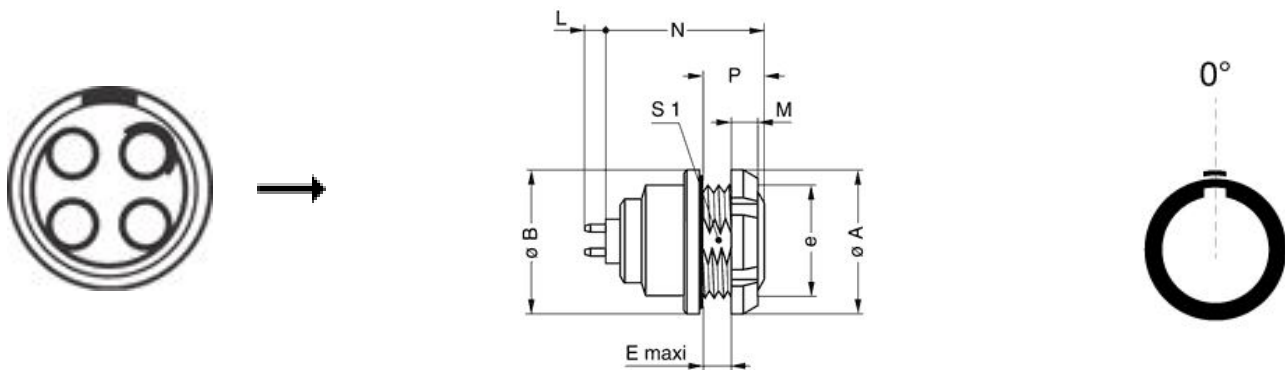

Dimensions

	A	B	E	M	N	P	S1	e
mm.	18	18	3.4	3.5	17.6	7	12.5	M14x1.0
in.	0,71	0,71	0,13	0,14	0,69	0,28	0,49	

RECOMMENDED BY LEMO

Tools

LEMO products and services are provided "as is". LEMO makes no warranties or representations with regard to LEMO product & services or use of them, express, implied or statutory, including for accuracy, completeness, or security. The user is fully responsible for his products and applications using LEMO components.

LEMO products and services are provided "as is". LEMO makes no warranties or representations with regard to LEMO product & services or use of them, express, implied or statutory, including for accuracy, completeness, or security. The user is fully responsible for his products and applications using LEMO components.

Mouser Electronics

Authorized Distributor

Click to View Pricing, Inventory, Delivery & Lifecycle Information:

[LEMO:](#)

[EEG.0K.304.CLN](#)