

SUMMARY



Image is for illustrative purpose only

Wires

Low voltage 12

Series 2B
Termination type Female solder
IP rating 50
AWG wire size 30.00 - 22.00
Cable Ø 0.00 - 0.00 mm
Status active
Matching parts [FGA.2B.312.CLAD52](#)

Download

[Request a quote](#)
[Eplan](#)
[Catalog](#)

TECHNICAL DETAILS

Mechanics

Shell Style/Model EC*: Fixed receptacle with two nuts (back panel mounting)
Keying 2 keys (alpha=30, plug: male contacts, receptacle: female contacts)
Housing Material Brass (chrome plated [SAE AMS 2460]) shell and collet nut, nickel plated [SAE AMS QQ N 290] brass latch sleeve and mid pieces
Weight 14.45 g

Performance

Configuration 2B.312 : 12 Low Voltage
Insulator L: PEEK (UL 94 / V-0/1.5)
Rated Current 7 Amps

Specifications

Contact Type: Solder
Contact Dia.: 0.7 mm (0.028in)
Bucket Dia.: 0.8 mm (0.031in)
Max. Solid Conductor: 0.34 mm² (AWG 22)
Max. Stranded Conductor: 0.34 mm² (AWG 22)
R (max): 6.1 mOhm
Vtest (contact-shell): 1350 V (AC), 1910 V (DC)
Vtest (contact-contact): 1250 V (AC), 1770 V (DC)

LEMO products and services are provided "as is". LEMO makes no warranties or representations with regard to LEMO product & services or use of them, express, implied or statutory, including for accuracy, completeness, or security. The user is fully responsible for his products and applications using LEMO components.

Others

Endurance (Shell): 5000
 Temp (min / max): -55° C / +250° C
 Humidity (max): <=95% [at 60 deg C / 140 F]
 Vibration: 15 g [10 Hz - 2000 Hz]
 Shock Resistance: 100 g [6 ms]
 Climatical Category: 50/175/21
 Shielding (min): 75 dB (10 MHz)
 Shielding (min): 40 dB (1 GHz)
 Salt Spray Corrosion: >1000 hr

DRAWINGS

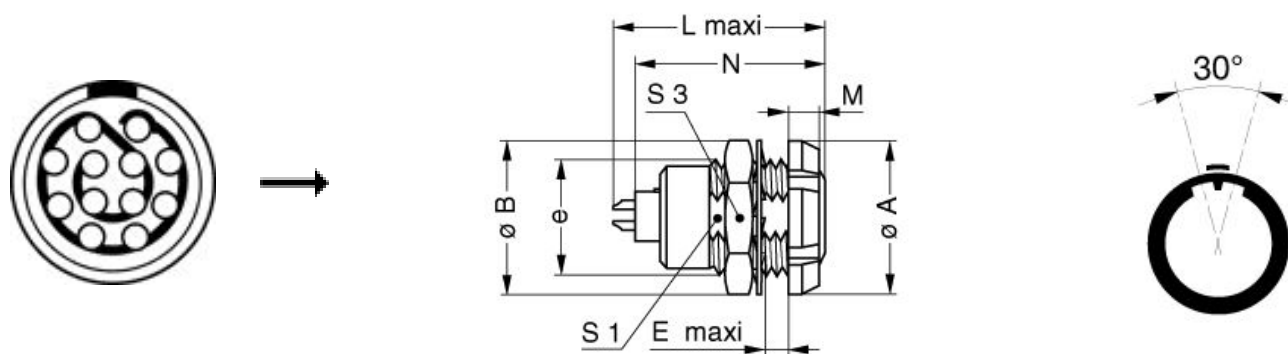

Dimensions

	A	B	E	L	M	N	S1	S3	e
mm.	20	19.2	6.5	26.7	3.5	24.6	13.5	17	M15x1.0
in.	0,79	0,76	0,26	1,05	0,14	0,97	0,53	0,67	











RECOMMENDED BY LEMO

Tools

Spanner 2: [DCH.91.201.PA](#)

LEMO products and services are provided "as is". LEMO makes no warranties or representations with regard to LEMO product & services or use of them, express, implied or statutory, including for accuracy, completeness, or security. The user is fully responsible for his products and applications using LEMO components.

Cables

CMN.12.T22.070QGZE	TPR (medical)	Grey	
CMN.12.T28.054PGZE		Grey	
CMN.12.T28.054PNZE			
112240	PTFE	White	
112260	PTFE	White	
112280	PVC	Black	
12050	PVC	Black	
124080	PVC	Grey	
124084	PVC	Black	
212220	PVC	Black	
212240	PVC	Black	
212250	PVC	Grey	
212260	PVC	Black	

LEMO products and services are provided "as is". LEMO makes no warranties or representations with regard to LEMO product & services or use of them, express, implied or statutory, including for accuracy, completeness, or security. The user is fully responsible for his products and applications using LEMO components.

Mouser Electronics

Authorized Distributor

Click to View Pricing, Inventory, Delivery & Lifecycle Information:

[LEMO:](#)

[ECA.2B.312.CLL](#)